

2CSC400003B0202



Summary

Introduction

1

Application sheets

2

Selection tables

3



The ABB Line Protection Devices quality system is conforming with the ISO 9001 Vision 2000

international Standard (model for quality assurance as regards design, development, construction, installation and service) and to the equivalent EN ISO 9001 European Standard.

ABB commitment to protecting the environment is also shown in concrete way by the Life Cycle Assessments of the products, which is being realized directly by ABB Research and Development.

All the products of Compact Home range are conforming to the European standards 2002/95/CE regarding the restrictions on the use of certain dangerous substances in the electrical and electronical equipments.

It is necessary to respect the local regulations concerning the elimination of the packaging materials and of the circuit-breakers and, if possible, to recycle them.

The symbol  marked on the product means that the circuit breaker must not be eliminated together with the general litter.



Compact Home



All Compact Home devices comply to European and international product standards:

- IEC/EN 61008 (RCCBs)
- IEC/EN 61009 (RCBOs)
- IEC/EN 60898 (MCBs)
- IEC/EN 60947-3 (Switches)
- IEC/EN 60669-1 (Dimmers)
- IEC/EN 61643-11 (SPDs)
- IEC/EN 60730-1 (Timers)
- IEC/EN 61558-1-2-8 (Transformers)
- IEC/EN 60439-1 (Busbars)

They are also conforming to the following EC directives:

- Low Voltage Directives (LVD) no. 73/23 EEC
- Electromagnetic Compatibility Directive (EMC) no.89/336 EEC and 92/31 EEC

CE marking of Compact Home devices warrants free circulation and sale in European Union. It is realized on supplier's responsibility, in addition to this marks and approvals, guarantee functioning, compatibility and safety conforming to national and international Standards.

ABB Compact Home RCDs also obtained the following national and international approvals:



Thanks to these approvals, the devices can be used without restriction as devices for the world market.



Compact Home Introduction

1

Family: F 200 = RCCBs
 H for HOME
 N° of poles: 2; 4
 Type: AC, A

Sensitivity: 0,03A, 0,1A ...
 Current: 25A; 40A; 63A
 Indication of device's rated voltage
 Indication of short circuit coordination performance:
 $I_m = I_{\Delta m} = 1000A$
 $I_m = I_{dm} = 1000A$
 $I_{nc} = 6000kA$ with a gL 63A fuse
 Wiring diagrams to prevent from a wrong connection

25A $I_{\Delta n} = 0,03A$
 $U_n = 230V \sim$
 $I_m = I_{\Delta m} = 1000A$
 63A $I_{nc} = 6000$
 1/2 3/4
 2/1 4/3

Failsafe bi-directional cylinder-lift terminal at top and bottom
 Indication of the marks and approvals the devices have been obtained
 Test button to be tested monthly
 Laserprint on side of mounting instruction and of the symbol \times which means that the circuit-breaker must be thrown away separately
 Black toggle to identify Compact Home range
 ABB identity number for a quickly identification of the product

202-AC
 25A $I_{\Delta n} = 0,03A$
 $U_n = 230V \sim$
 $I_m = I_{dm} = 1000A$
 63A $I_{nc} = 6000$
 1/2 3/4
 2/1 4/3
 2CSP204002R1250

for more information about this products, see the technical catalogue

Compact Home Introduction



Cage terminals up and bottom

Family: S 200 = MCBs

H for HOME

N° of poles:
1; 1+N; 2; 3; 3+N; 4

Breaking capacities:
T=3kA, L=4.5kA,
no-one=6kA

Wiring diagrams to prevent wrong connection on all pole versions

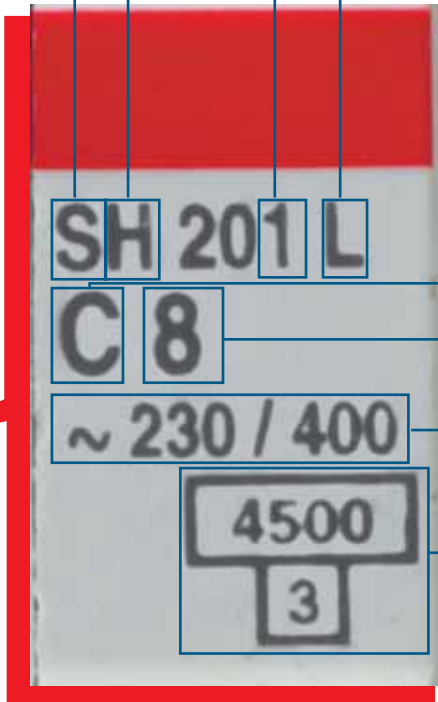

Characteristic: B, C

Rated current:
6A; 10A; ... 63A

Indication of MCB rated voltage

Indication of MCB breaking capacity and limitation class

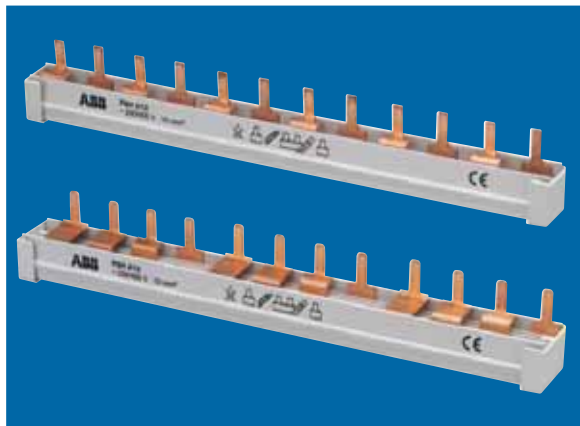

for more information about this products, see the technical catalogue



Index

Basic solution for consumer units installed in a little flat (<35 m ²)	2/2
Advanced solution for consumer units installed in a little flat (<35 m ²)	2/3
Basic solution for consumer units installed in a big flat (between 35 and 100 m ²)	2/4
Advanced solution for consumer units installed in a big flat (between 35 and 100 m ²)	2/6
Basic solution for consumer units installed in an independent house/villa (>100 m ²)	2/8
Advanced solution for consumer units installed in an independent house/villa (>100 m ²)	2/10
Notes for use, special features	2/12
Technical features of MCBs SH 200 series	2/14

Compact Home Application sheets

Basic solution for consumer units installed in a little flat (<math><35\text{ m}^2</math>)

The simplest possible solution:
1 RCCB $I_{\Delta n}=30\text{mA}$: protection also against direct contacts
2 MCBs: one with $I_n=10\text{A}$ to protect lights circuit and one with $I_n=16\text{A}$ to protect sockets circuit

2

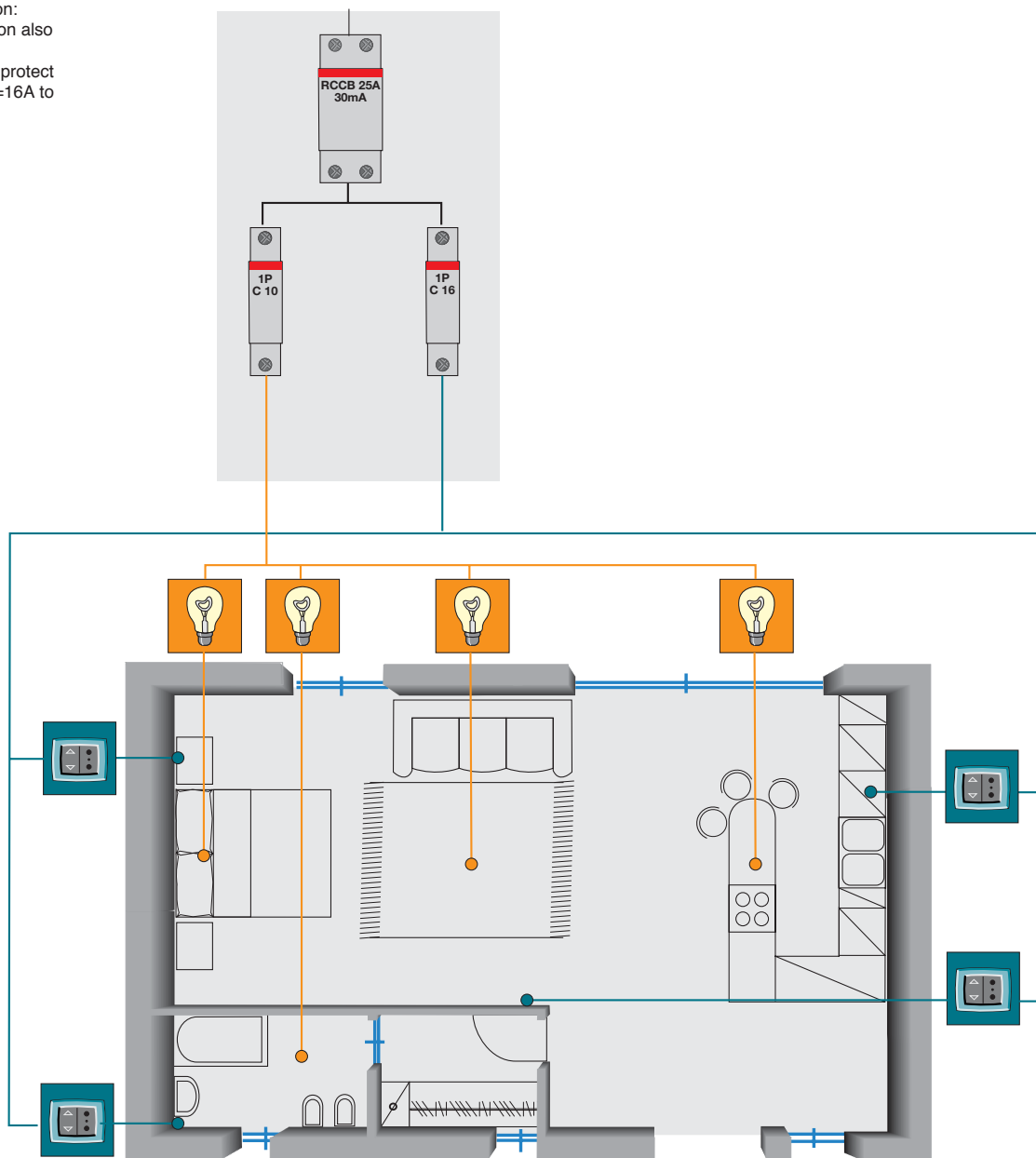

Compact Home Application sheets

Advanced solution for consumer units installed in a little flat (<35 m²)

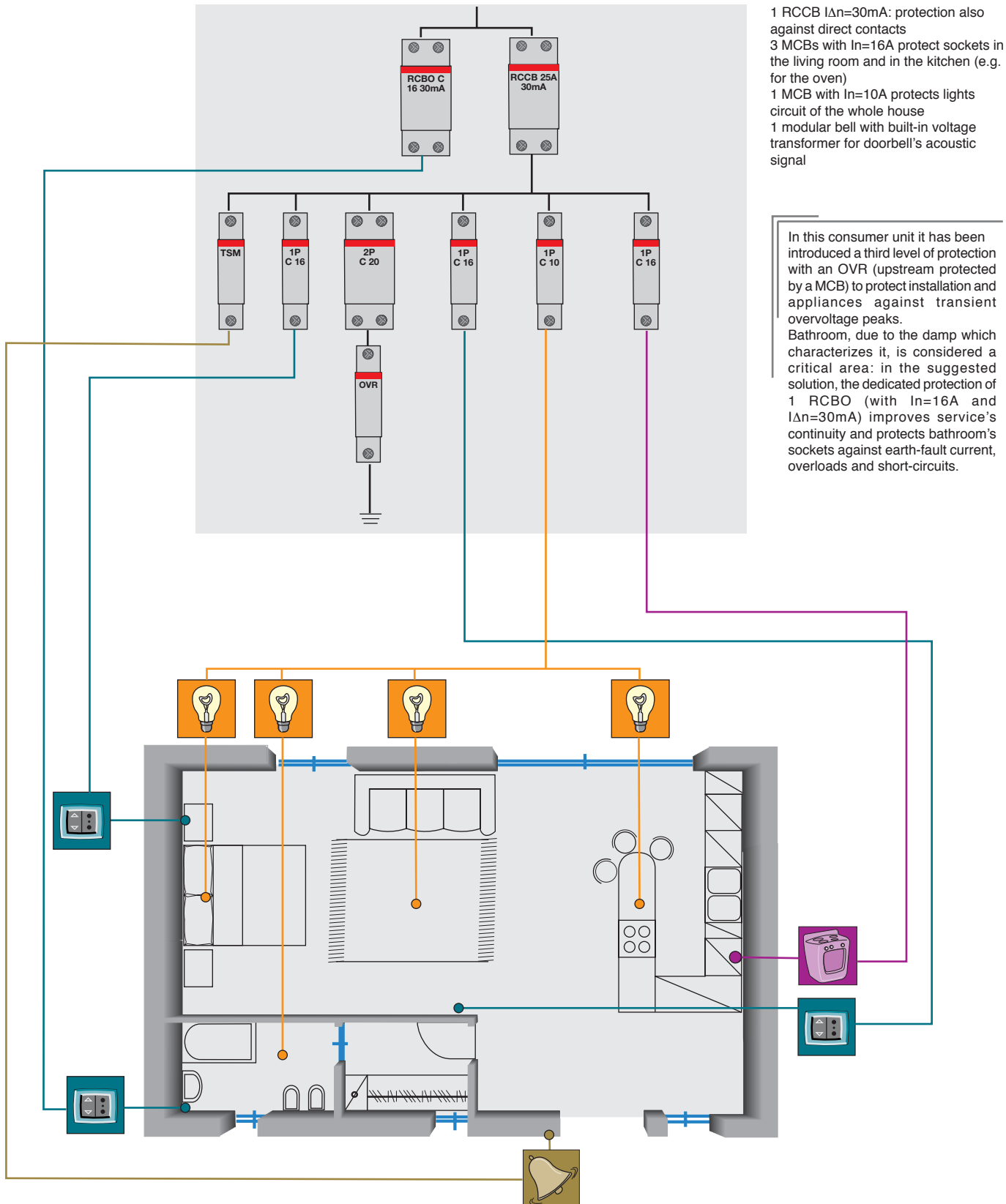

2

Compact Home Application sheets

Basic solution for consumer units installed in a big flat (between 35 and 100 m²)

- 1 MCB used as main switch of the consumer unit
- 3 RCCBs: one with In=40A protects sockets circuit of the living room, kitchen and laundry-room and two with In=25A protect respectively sockets circuit of the bedrooms and bathroom and lights circuit of the whole house
- 2 MCBs In=10A protect lights circuits of bedrooms and bathroom separately from lights circuits of the rest of the house
- 6 MCBs In=16A (3 per RCCB) protect sockets
- 1 OVR protects against transient overvoltage peaks

In this consumer unit has been introduced some typical function in a modular shape: a voltage transformer (TS) supplies a bell (SM) for doorbell's acoustic signal and a buzzer (RM) for emergency acoustic signal in the bathroom.

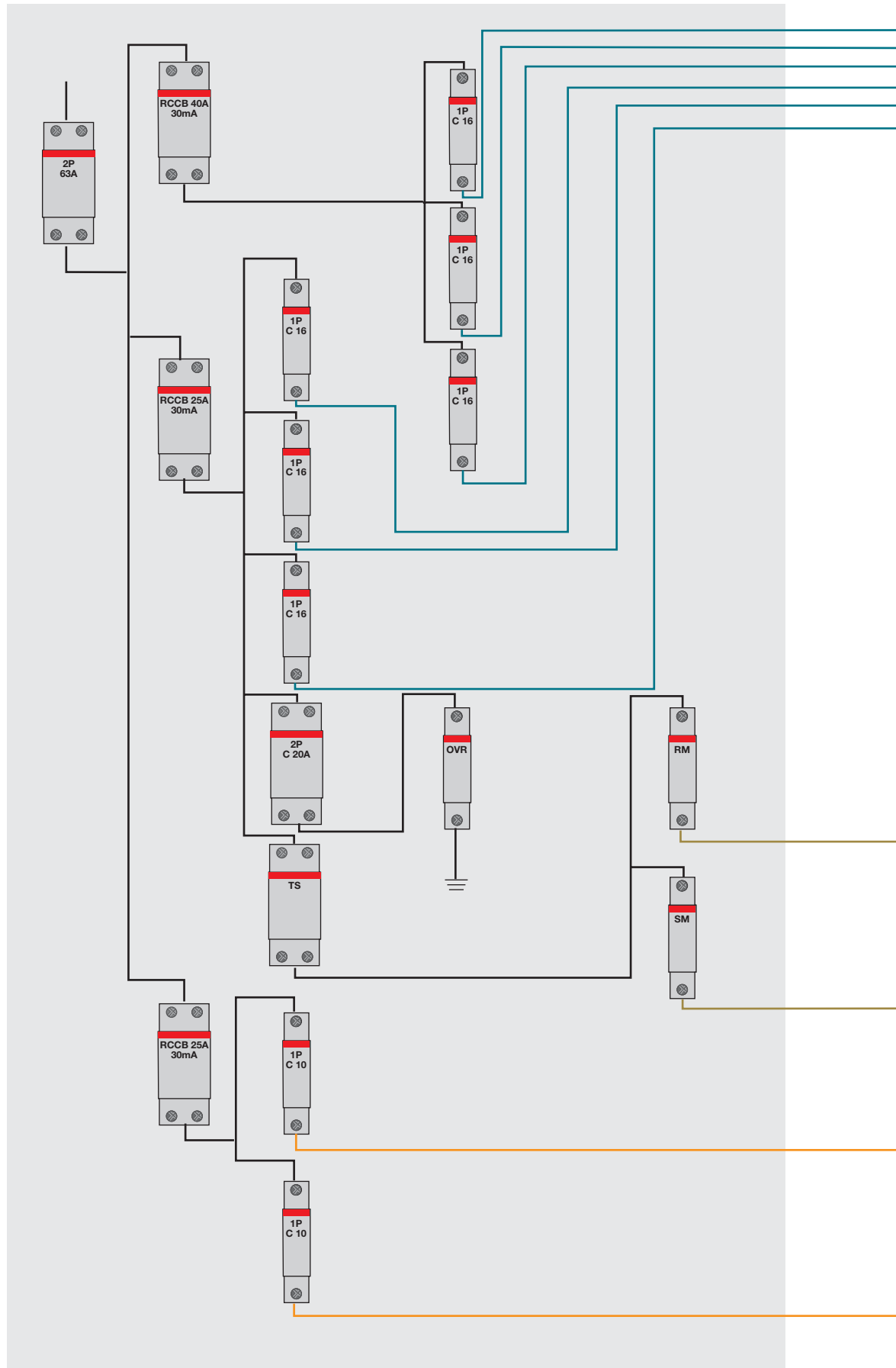

Compact Home Application sheets

Basic solution for consumer units installed in a big flat (between 35 and 100 m²)

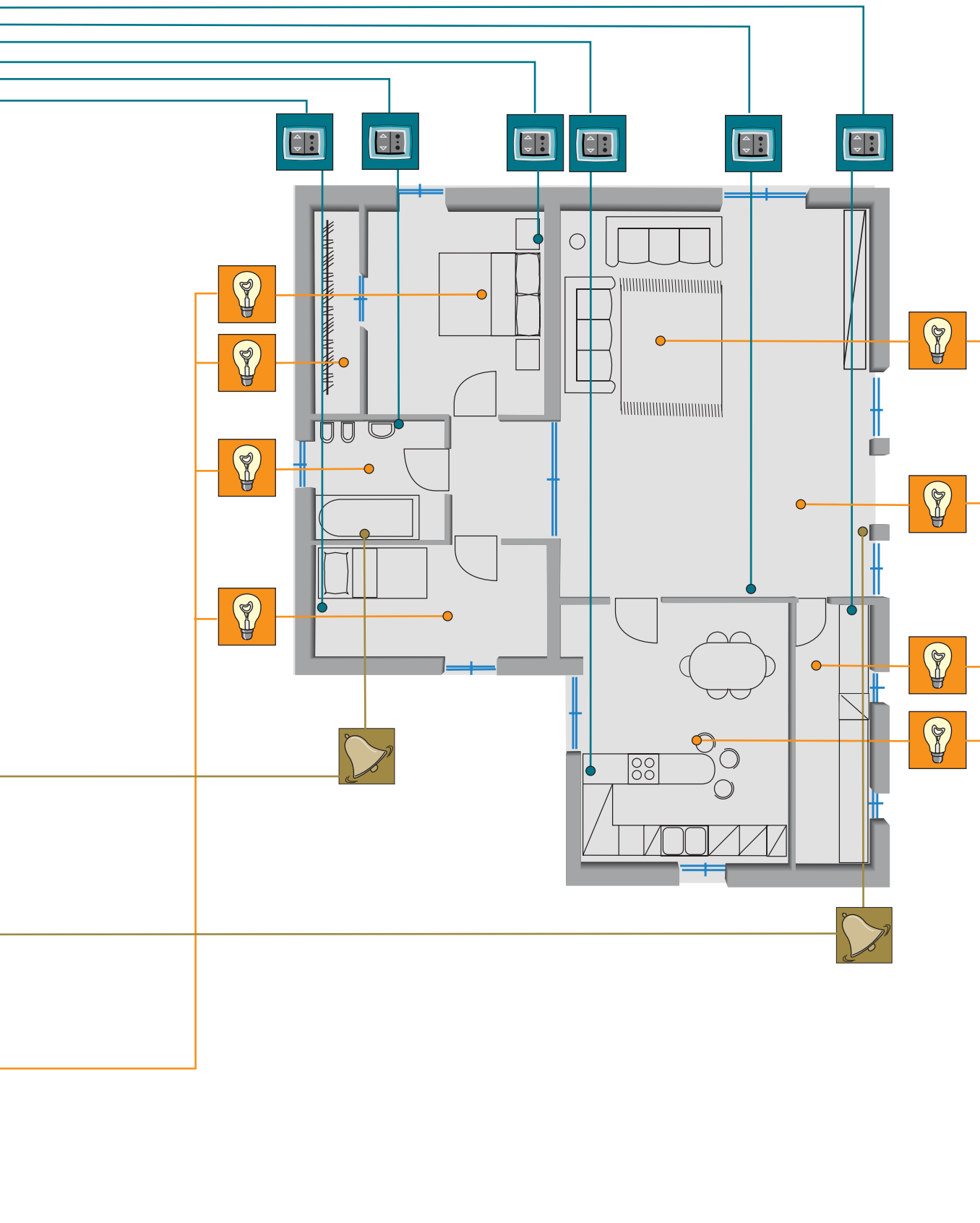

Advanced solution for consumer units installed in a big flat (between 35 and 100 m²)

- 1 MCB used as main switch of the consumer unit
- 2 RCCBs: one with In=40A protects sockets circuit and electric household appliances in the kitchen and one with In=25A protects remaining sockets and all the other devices
- 2 RCBOs protect separately sockets circuits of the bathroom and of the laundry
- 10 MCBs In=16A or In=10A protect sockets and lights circuits of the house
- 1 OVR protects against transient overvoltage peaks
- 1 modular bell with built-in voltage transformer for doorbell's acoustic signal
- 1 LSS1/2 for load management

In this consumer unit a DTS-TWS (time switch + twilight switch) allows the time programming of the external and entrance lights in relation to the environmental light level. One E 259 (installation relay), equipped with contact position indicator, allows the manual control of the boiler in the bathroom.

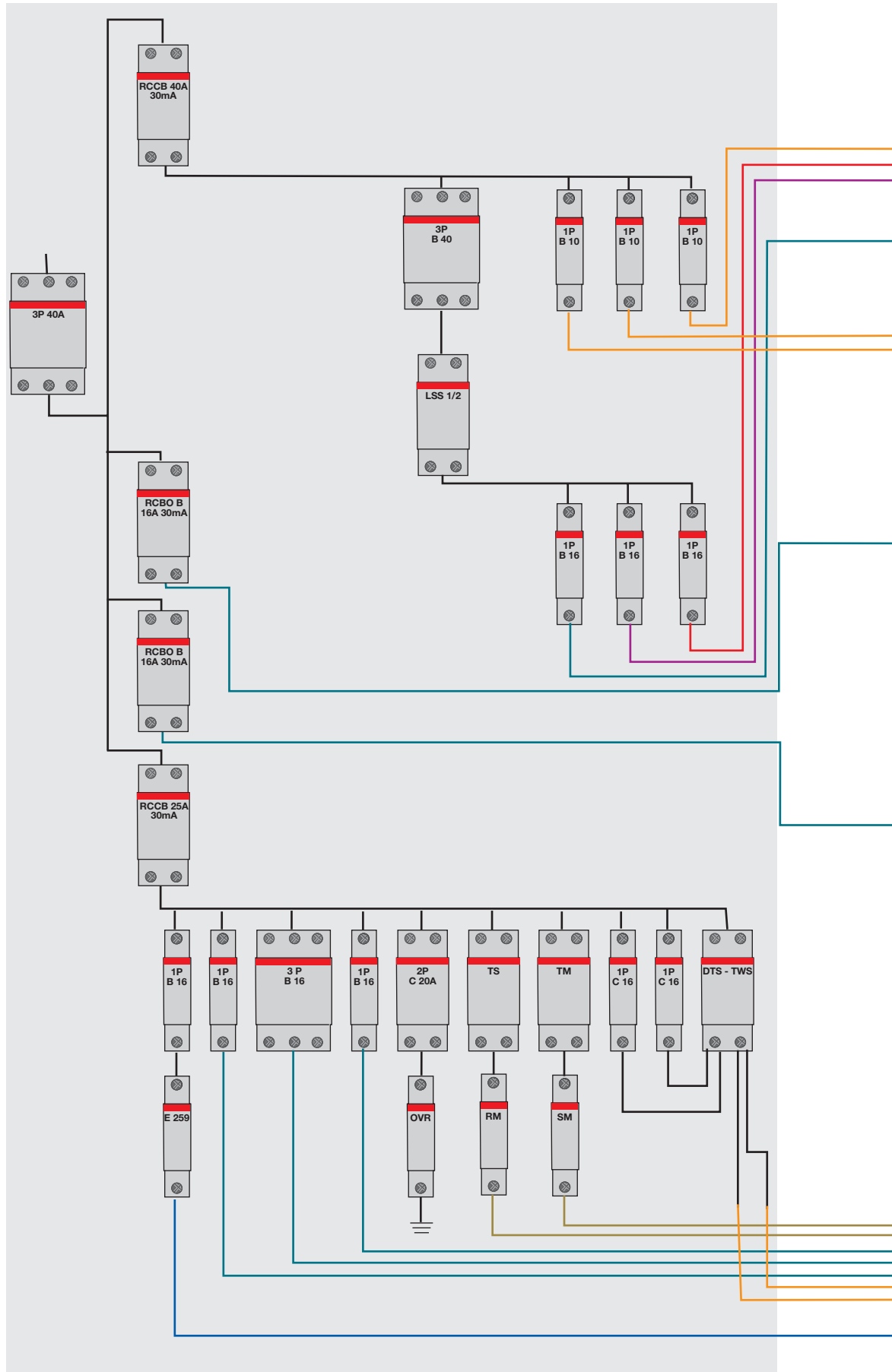

Compact Home Application sheets

Advanced solution for consumer units installed in a big flat (between 35 and 100 m²)

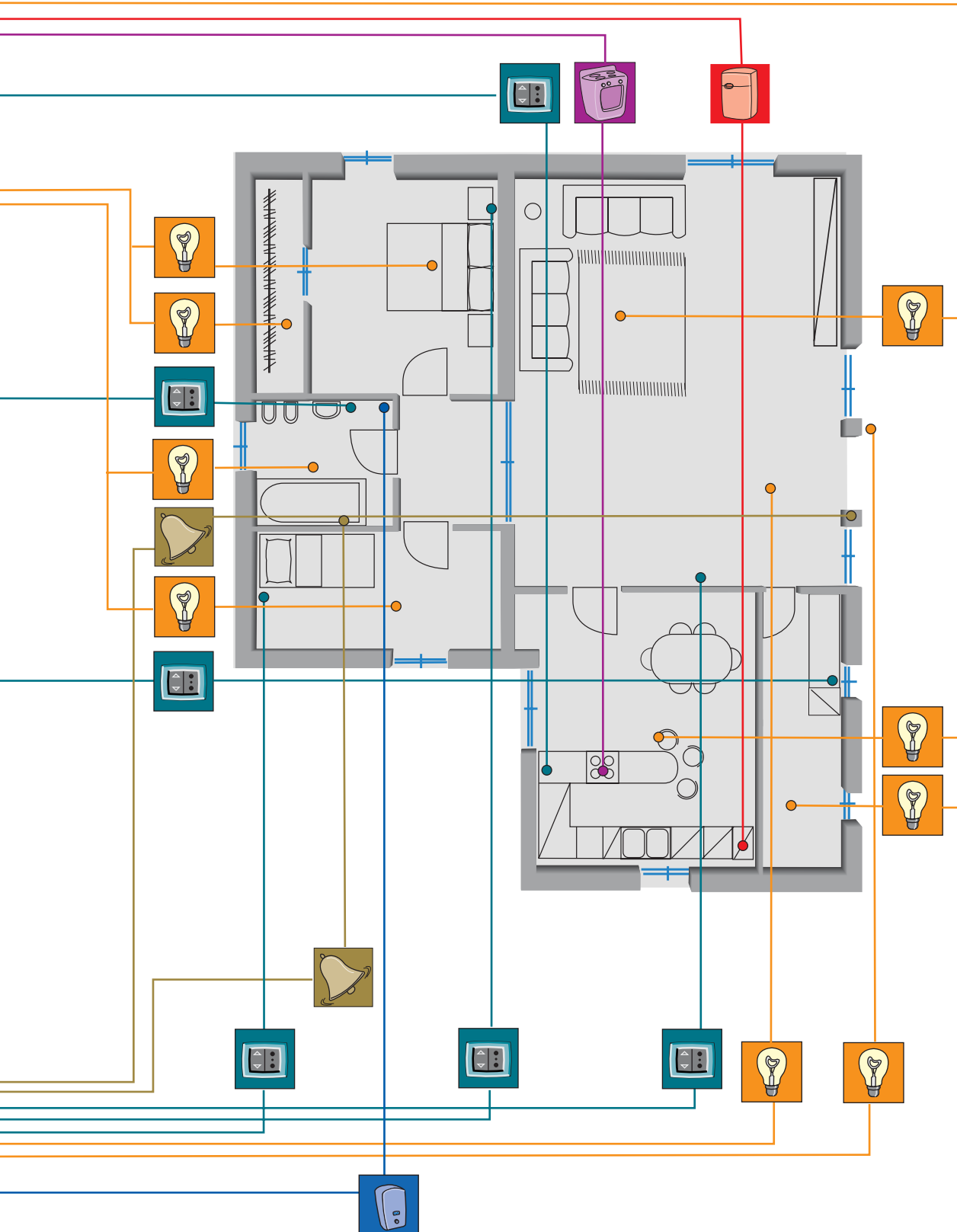

2

Compact Home Application sheets

Basic solution for consumer units installed in an independent house/villa (>100 m²)

- 1 MCB used as main switch of the consumer unit
- 3 RCCBs with In=40A protect sockets and lights circuits of the house
- 2 RCBOs protect separately sockets in the garage and in the swimming pool
- 13 MCBs In=16A or In=10A protect sockets and lights circuits of the house
- 1 OVR protects against transient overvoltage peaks
- 1 modular bell and 1 buzzer for acoustic signals
- 1 DTS-TWS for lights time programming
- 1 E 259 for manual controlling of the boiler

2

In this consumer unit the E 200i is used as main disconnecting means of the external circuit (which, for example, can be used for the sockets or the pump of the swimming pool, always turned off during the winter). The LSS1/2 is a load shedding switch: it avoids the tripping of the main circuit-breaker through switching-off in sequence of maximum two not primary loads when the preset threshold is exceeded (it could be useful to set refrigerator as primary load to warrant service's continuity).

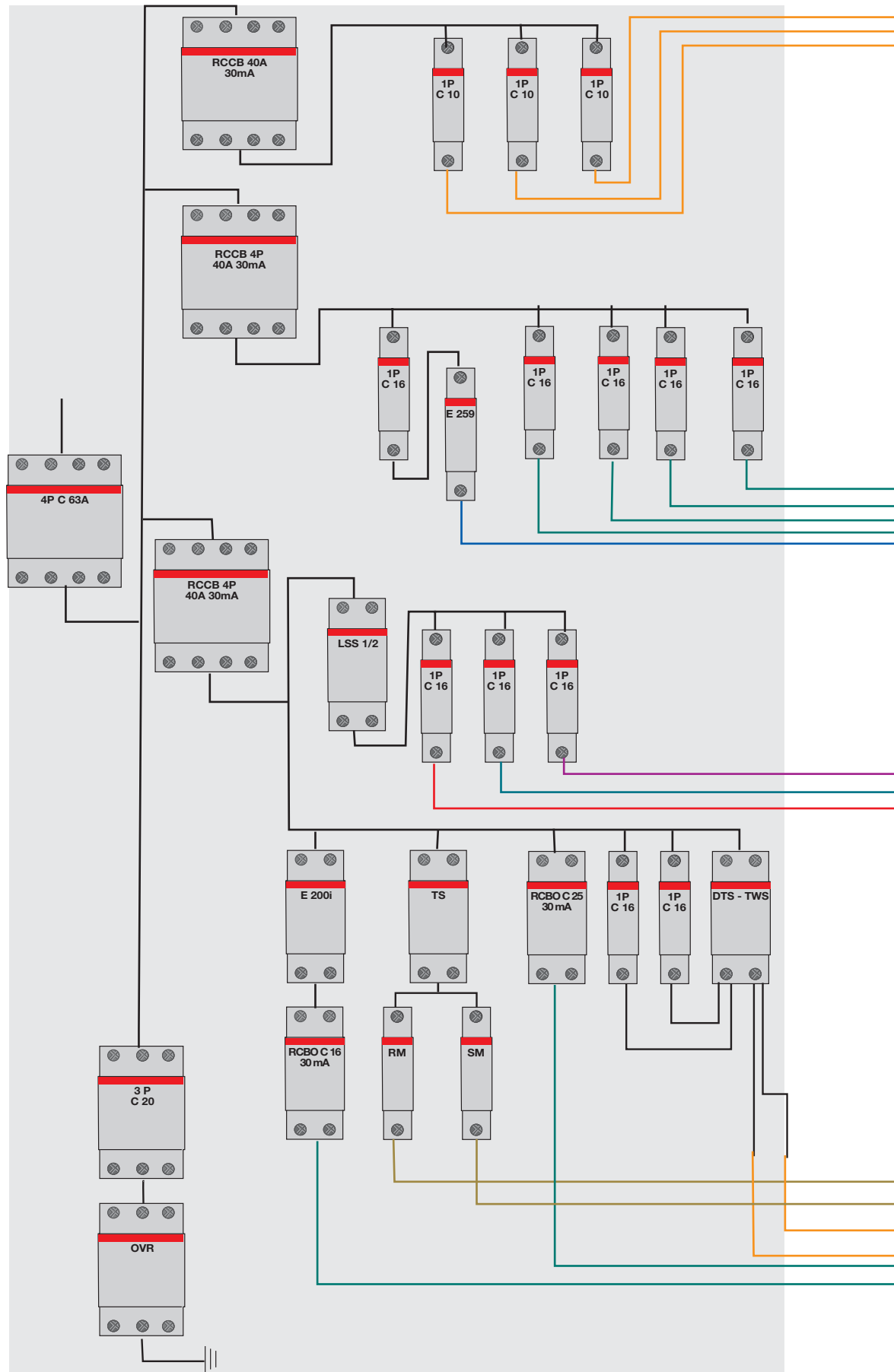

Compact Home Application sheets

Advanced solution for consumer units installed in an independent house/villa (>100 m²)

- 1 MCB used as main switch of the consumer unit
- 3 RCCBs protect sockets and lights circuits of the house
- 6 RCBOs protect separately the critical lines of the house
- 13 MCBs In=16A or In=10A protect sockets and lights circuits of the whole house
- 1 OVR protects against transient overvoltage peaks
- 1 modular bell and 1 buzzer for acoustic signals
- 1 LSS1/2 for the load management of the electric household appliances in the kitchen
- 1 E 200i separately controls the external sockets
- 1 DTS-TWS for lights time programming
- 1 E 259 for manual controlling of the boiler

In the living room, the E 255 (latching relay) allows the light sequential control through a single pushbutton circuit. The E 232 (staircase timer) permits the lighting time delay in the garage, so it is not possible to forget light turned on.

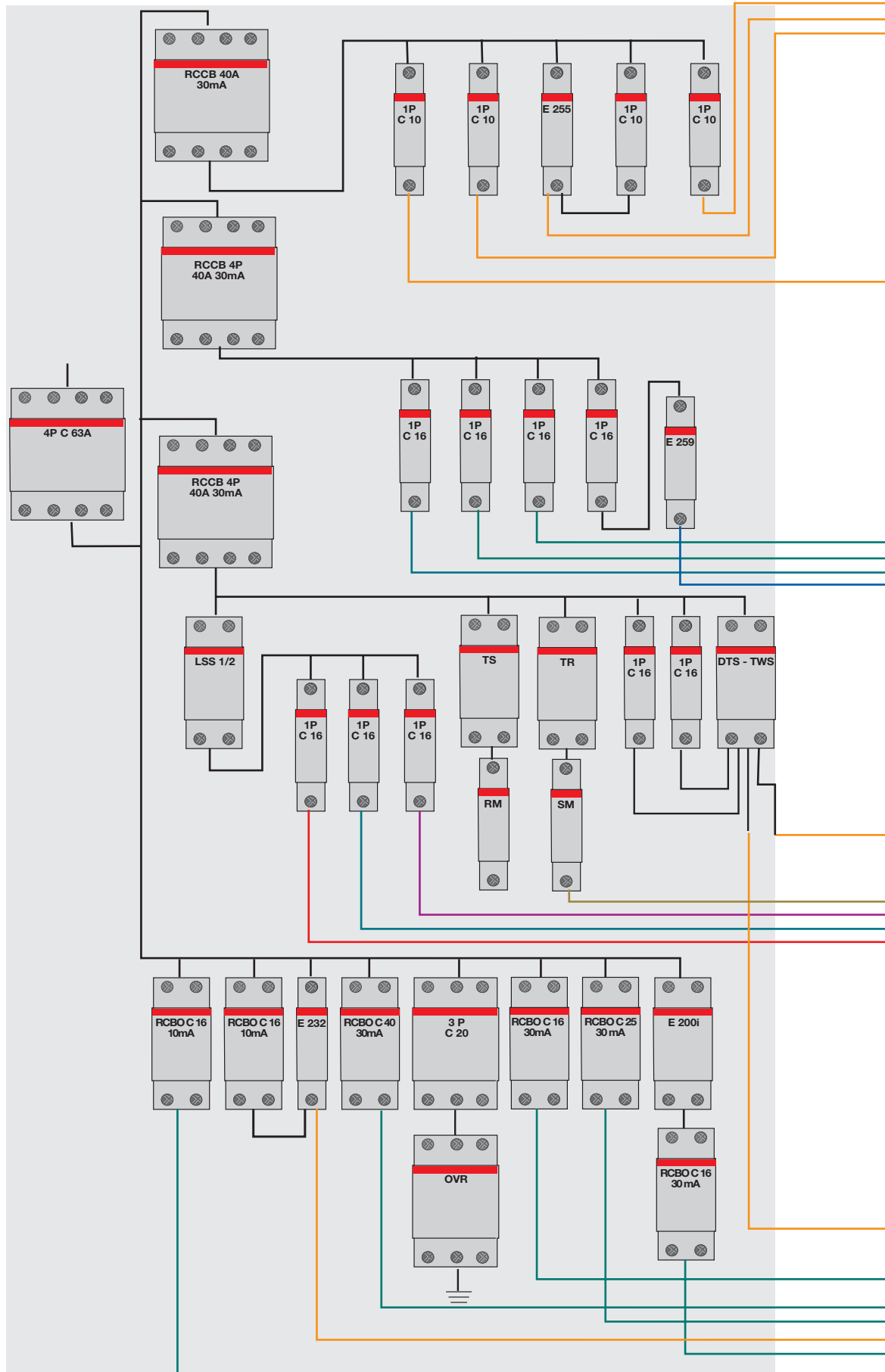

Compact Home Application sheets

Advanced solution for consumer units installed in an independent house/villa (>100 m²)

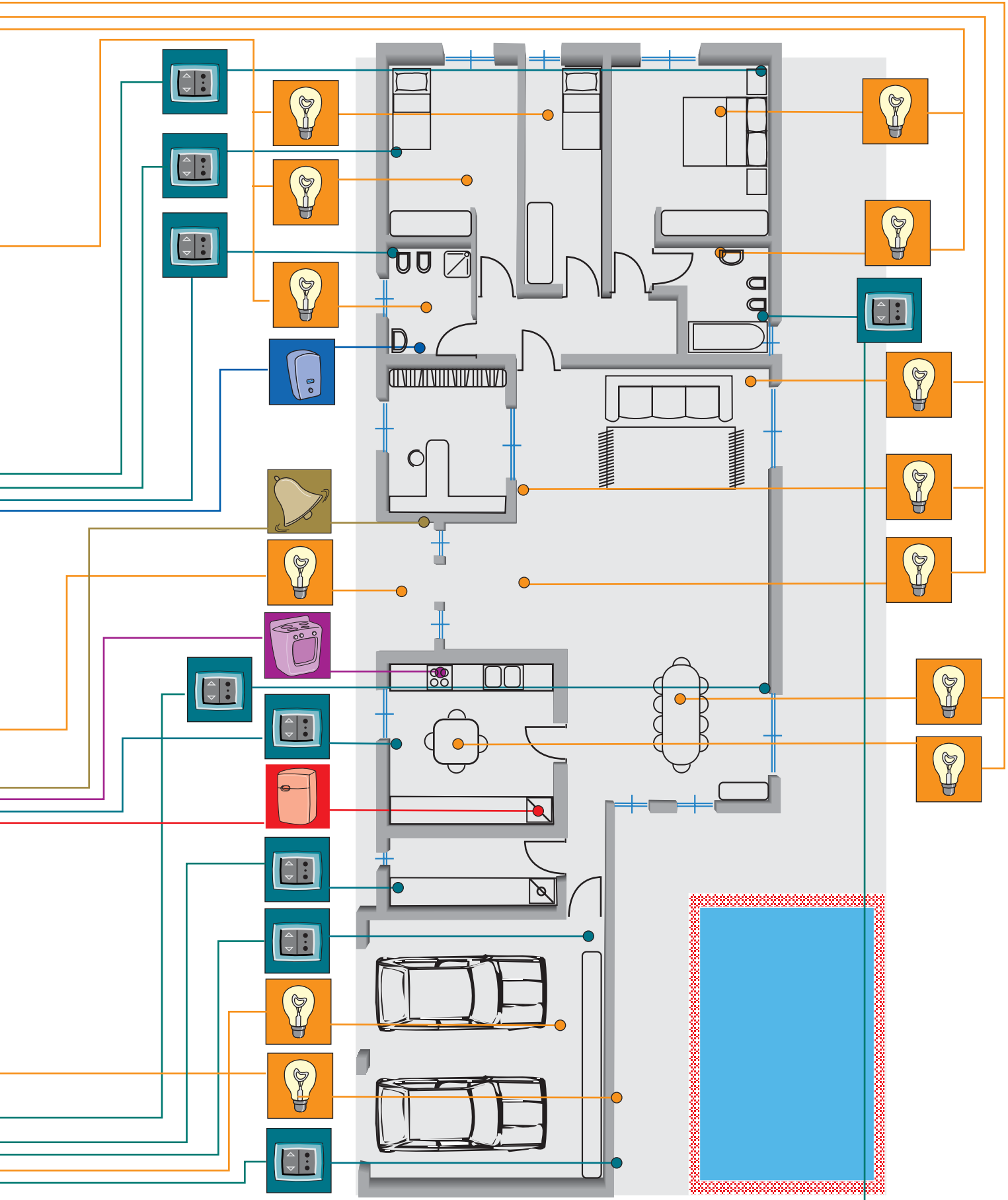

2

Easy to handle –

● The MCB's Compact Home are equipped with 25 mm² cage terminals, a well proven and reliable technology.

● The terminals accept not only single wires, but as well several conductors of the same size e.g. 6 x 1.5 mm² or even conductors with different cross sections e.g. 1 x 6 mm² and 1 x 2.5mm².

● The cross wiring can easily be done by inserting the Compact Home busbars and then the incoming wires into one of the MCB's terminals.

● The terminals accept Compact Home busbars and conductors up to 16 mm² together.



- Compact Home



When Compact Home RCCB's or E 200- isolators are used as main incomers the Compact Home busbars perfectly fit into all possible combinations.

Compatibility with pro M compact is given in all kind of variations like:

Insertion of 1 pro M compact MCB (e.g. K-characteristic) into an Installation with Compact Home components and Compact Home busbars.

Also the combination of 1 Compact Home MCB with pro M compact components and pro M compact busbars is not a problem.

SH 200 T SH 200 L SH 200

Electrical features	Standards	IEC/EN 60898				
	Rated current in	A	6 - 40			
	Poles	1, 2, 3, 4, 1+NA, 3+NA				
	Rated Voltage Ue	IEC 1P, 1P+N	V	230		
		IEC 2P, 3P, 3P+N, 4P	V	230/400		
	Insulation voltage Ui	V		250		
	Max. operating voltage Ub max.	IEC AC		V 254/440		
	Min. operating voltage Ub min.	V		12 V AC - 12 V DC		
	Rated frequency	Hz		50...60		
	Rated breaking capacity acc. to IEC/EN 60898	ultimate Icn	A	3000	4500	6000
Mechanical features	Rated impulse withstand voltage (1.2/50) Uimp	KV	4 (test voltage 6,2. at sea level 5 at 2000 m)			
	Dielectric strength at power freq. for 1 min.	KV	2,5			
	Overvoltage category	III				
	Pollution degree	2				
	Thermomagnetic release characteristic	B: $3 I_n \leq I_m \leq 5 I_n$		•	•	•
		C: $5 I_n \leq I_m \leq 10 I_n$		•	•	•
	Toggle	black sealable in ON-OFF position				
	Electrical life	10000				
	Mechanical life/operations	20000				
	Protections degree/operations	housing	IP4X			
terminals		IP2X				
Mechanical shock resistance	30 g - 2 shocks - duration 11 ms					
Resistance to vibrations acc. to IEC/EN 60060-2--6	5 g - 20 cycles at frequency 5...150...5 Hz with 0,8 x In					
Installation	Tropicalization acc. to IEC/EN 60068-2	humid heat	°C/RH	28 cycles with 55/95...100		
		constant climatic conditions	°C/RH	23/28 - 40/93 - 55/20		
		variable climatic conditions	°C/RH	25/95 - 40/95		
	Reference temperature for setting of thermal element	°C		30		
	Ambient temperature (with daily averages $\leq +35^\circ\text{C}$)	IEC	°C		-25...+55	
	Storage temperature	°C		-40...+70		
	Terminal type	cage terminal				
	Terminal size top/bottom for cable	IEC	mm ²	25/25		
		UL/CSA	AWG	18-4		
	Tightening torque	IEC	N*m	2.5		
UL/CSA		in-lbs.	22			
Tool	Nr. 2 Pozidriv					
Mounting	on DIN rail EN 60715 (35 mm) by means of fast clip device					
Mounting position	optional					
Connection	from top and bottom					
Dimensions and weigh	Pole dimensions (H x D x W)	mm	85 x 69 x 17.5			
	Pole weight	g	125			

Tripping diagrams

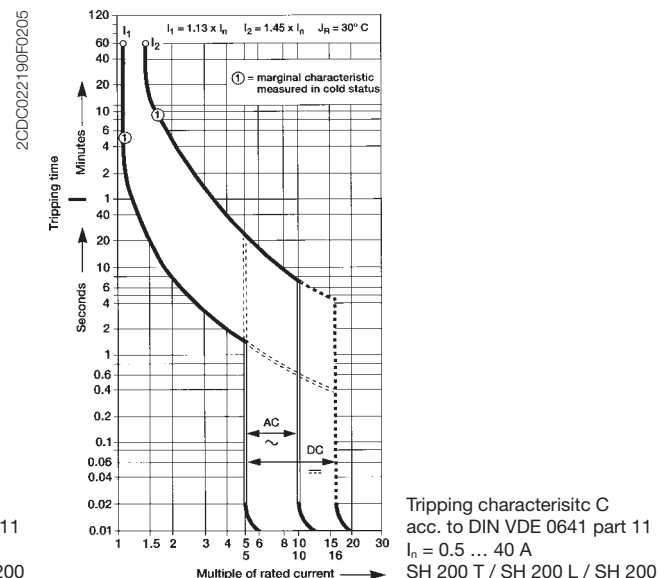
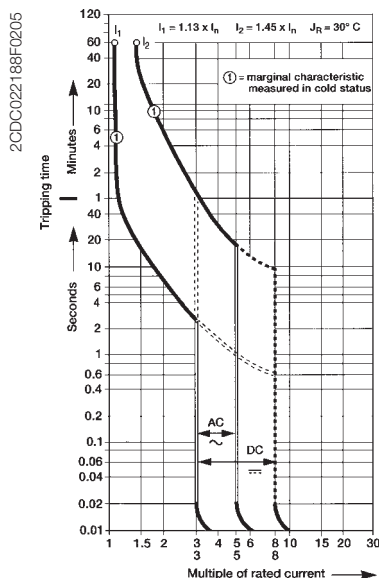

Compact Home

Internal resistances and power losses of the Miniature Circuit-Breakers

Internal resistances per pole in m
Power losses per pole in W

Type	Rated current A	Range SH 200 T		Range SH 200 L		Range SH 200	
		B, C m	W	B, C m	W	B, C m	W
SH 200	6	55	2.0	55	2.0	55	2.0
	8	15	1.0	15	1.0	15	1.0
	10	13.3	1.3	13.3	1.3	13.3	1.3
	13	13.3	2.3	13.3	2.3	13.3	2.3
	16	7.0	1.8	7.0	1.8	7.0	1.8
	20	6.25	2.5	6.25	2.5	6.25	2.5
	25	5.0	3.2	5.0	3.2	5.0	3.2
	32	3.6	3.7	3.6	3.7	3.6	3.7
	40	3.0	4.8	3.0	4.8	3.0	4.8

Tripping characteristics

acc. to	Tripping characteristic	Thermal trips ①			Electromagnetic trips ②		Tripping-time
		Test currents: Low test current I_1	High test current I_2	Tripping-time	Test currents: hold current surges of	trip at least at	
IEC/EN 60898	B	$1.13 \cdot I_n$	$1.45 \cdot I_n$	$> 1 \text{ h}$ $< 1 \text{ h}$ ③	$3 \cdot I_n$	$5 \cdot I_n$	$0.1 \text{ s} \dots 45 \text{ s} \leq 32 \text{ A} / 0.1 \text{ s} \dots 90 \text{ s} \geq 32 \text{ A}$ $< 0,1 \text{ s}$
	C	$1.13 \cdot I_n$	$1.45 \cdot I_n$	$> 1 \text{ h}$ $< 1 \text{ h}$ ③	$5 \cdot I_n$	$10 \cdot I_n$	$0.1 \text{ s} \dots 45 \text{ s} \leq 32 \text{ A} / 0.1 \text{ s} \dots 30 \text{ s} \geq 32 \text{ A}$ $< 0,1 \text{ s}$

① Influence of ambient temperature see below.

② The tripping for the electromagnetic trip are valid for AC 50... 60 Hz.
For other frequencies see table below.

③ From warm operating condition (After $I_1 > 1 \text{ h}$ resp. 2 h)

Influence of frequency on electromagnetic trips

The stated tripping values of the electromagnetic trips are valid for a frequency of 50... 60 Hz. In case of frequencies deviating from 50... 60 Hz as well as direct current the tripping values are changed by the factor mentioned below.

	AC			DC
	100 Hz	200 Hz	400 Hz	
Factor approx.	1.1	1.2	1.5	1.5

The tripping values of the thermal trips are independent of the frequency

Influence of ambient temperature

The thermal trips are calibrated for an ambient temperature 30 °C for B- and C-characteristic.

In the case of temperatures deviating from these values the tripping values

- are reduced in case of higher temperatures
- are increased in case of lower temperatures

The electronic tripping is not dependent on temperature

Compact Home

Current-carrying capacity of the MCB's as a function of the ambient temperature

Max. operating current depending on the ambient temperature of a circuit-breaker in load circuit of characteristics type B, C and D

B, C	Ambient temperature T (°C)									
	-30	-20	-10	0	10	20	30	40	50	60
In (A)										
6.0	7.7	7.5	7.2	6.9	6.6	6.3	6.0	5.7	5.3	4.9
8.0	10.3	10.0	9.6	9.2	8.8	8.4	8.0	7.5	7.1	6.5
10.0	12.9	12.5	12.0	11.5	11.1	10.5	10.0	9.4	8.8	8.2
13.0	16.8	16.2	15.6	15.0	14.4	13.7	13.0	12.3	11.5	10.6
16.0	20.7	20.0	19.2	18.5	17.7	16.9	16.0	15.1	14.1	13.1
20.0	25.8	24.9	24.0	23.1	22.1	21.1	20.0	18.9	17.6	16.3
25.0	32.3	31.2	30.0	28.9	27.6	26.4	25.0	23.6	22.0	20.4
32.0	41.3	39.9	38.5	37.0	35.4	33.7	32.0	30.2	28.2	26.1
40.0	51.6	49.9	48.1	46.2	44.2	42.2	40.0	37.7	35.3	32.7

Mutual thermal influence in the case of simultaneous load

MCB's mounted in a row side bay side

MCB's mounted with a separating distance X

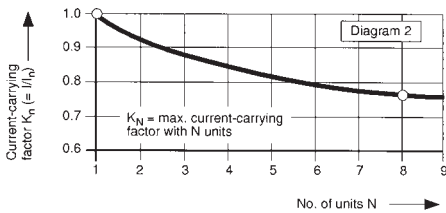

SK 0080 Z 93

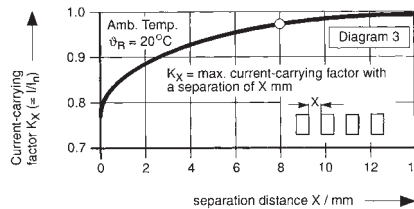

SK 0078 Z 93

Load data	from diagram	Calculation	Example
Rated current and characteristics of M.C.B. Continuous load Number of M.C.B.'s / Mounting distance		$I_n / B, C$ ϑ_R N / X	16 A – B 40 °C 8 pieces / 0 and 8 mm
Load ≤ 1 h	1 a resp. 1 b	$I = I_n \cdot K_{\theta}$	$16 \cdot 1.07 = 17.1 \text{ A}$
Continuous load > 1 h		$I = 0.9 \cdot I_n \cdot K_{\theta}$	$0.9 \cdot 16 \cdot 1.07 = 15.4 \text{ A}$
Continuous load, N M.C.B.'s, Distance 0	2	$I = 0.9 \cdot K_{\theta} \cdot K_N$	$0.9 \cdot 16 \cdot 1.07 \cdot 0.77 = 11.9 \text{ A}$
Continuous load, N M.C.B.'s, Distance X	3	$I = 0.9 \cdot K_{\theta} \cdot K_X$	$0.9 \cdot 16 \cdot 1.07 \cdot 0.98 = 15.1 \text{ A}$

Compact Home

Max. Back-up protection

SH 200 T / SH 200 L / SH 200	B/C Rated current	Max. Back-up protection	
		fuse	Main Circuit Breaker S 700
	6/8	63 A	100 A
	10... 32	100 A	100 A
	40	125 A	100 A

Maximum permissible earth-fault loop impedance Z_s at $U_0 = 230\text{ V} \sim$ ① to ensure compliance with the operation conditions pursuant to IEC 60364-4. Operating time $< 0.4\text{ s}$; at $400\text{ V} \sim < 0.2\text{ s}$ and at $> 400\text{ V} \sim < 0.1\text{ s}$. The instantaneous release of the MCB ensures an operating time of $\leq 0.1\text{ s}$ (TN system).

Determined according to DIN VDE 0100-520 sheet 2:2002-11 (source impedance = $300\ \Omega$, $c = 0.95$ and conductor temperature $70\text{ }^\circ\text{C}$ = factor 0.8). The internal resistance of the MCB is already included.

SH 200, SH 200 L, SH 200 T

Rated current I_n , A	B max. Z_s Ω	C max. Z_s Ω
6	7.7	3.8
8	–	2.8
10	4.6	2.2
13	3.5	1.7
16	2.9	1.4
20	2.3	1.2
25	1.8	0.9
32	1.4	0.7
40	1.1	0.6

① U_0 = rated voltage against earthed conductor; for $U_0 = 240\text{ V} \sim$ is $Z_s \cdot 1.04$; for $U_0 = 127\text{ V} \sim$ is $Z_s \cdot 0.55$

Take into account the voltage drop:

e.g. in the case of a 1.5 mm^2 conductor, protected by a B 16 circuit breaker, the maximum cable length is 82 m. If the voltage is below 3%, this would result in a maximum cable length (2-strand) of 17 m. For more details on this topic, get your own copy of the technical information leaflet "Maximum cable lengths".

Maximum cable length is the case of different voltages and cross sections on request.

Compact Home

Short circuit selectivity: In the case of a short circuit, selectivity exists up to the values indicated.

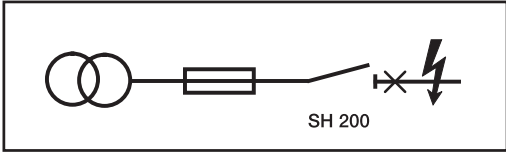
MCBs	short circuit discrimination in kA																			
																				
series	to main circuit breaker S 700 <small>SK 0112 Z 99</small>									to fuse gL/gG (DIN VDE 0636; IEC 269/3) <small>SK 0113 Z 99</small>										
	I_n A	16	20	25	35	40	50	63	80	100	16	20	25	35	50	63	80	100	125	160
SH 200 T – B, C	6	4,5	4,5	4,5	4,5	4,5	4,5	4,5	4,5	4,5	0.2	0.4	0.6	1.5	2.5	2.8	3	3	3	3
	8	4,5	4,5	4,5	4,5	4,5	4,5	4,5	4,5	4,5	0.3	0.6	1.4	2.4	2.6	3	3	3	3	3
	10	4,5	4,5	4,5	4,5	4,5	4,5	4,5	4,5	4,5	0.5	1.2	2.1	2.5	2.8	3	3	3	3	3
	13	4,5	4,5	4,5	4,5	4,5	4,5	4,5	4,5	4,5	0.4	1.0	1.8	2.4	2.8	3	3	3	3	3
	16	4,5	4,5	4,5	4,5	4,5	4,5	4,5	4,5	4,5	0.8	1.6	2.3	2.8	3	3	3	3	3	3
	20		4,5	4,5	4,5	4,5	4,5	4,5	4,5	4,5		1.5	2.1	2.5	2.5	3	3	3	3	3
	25			4,5	4,5	4,5	4,5	4,5	4,5	4,5		1.0	2.0	2.5	2.5	3	3	3	3	3
	32		**		4,5	4,5	4,5	4,5	4,5	4,5	no selectivity		1.9	2.5	2.5	3	3	3	3	3
	40					4,5	4,5	4,5	4,5	4,5		1.5	2	2	2	2	2	2	2	2
SH 200 L – B, C	6	6	6	6	6	6	6	6	6	6	0.2	0.4	0.7	1.8	3	5	4.5	4.5	4.5	4.5
	8	6	6	6	6	6	6	6	6	6	0.2	0.3	0.6	0.6	2.5	4	4.5	4.5	4.5	4.5
	10	6	6	6	6	6	6	6	6	6	0.3	0.6	1.4	2.3	3	4	4.5	4.5	4.5	4.5
	13	6	6	6	6	6	6	6	6	6	0.5	1.3	2	3	4	4.5	4.5	4.5	4.5	
	16	6	6	6	6	6	6	6	6	6	1	1.8	2.5	3.5	4.5	4.5	4.5	4.5		
	20		6	6	6	6	6	6	6	6		1.6	2.2	3	4	4.5	4.5			
	25			6	6	6	6	6	6	6		1.5	2.2	3	4	4.5	4.5			
	32		**		6	6	6	6	6	6	no selectivity		2	2.8	3.5	4.5	4.5			
	40					6	6	6	6	6		2	2.5	3	4.5	4.5				
SH 200 – B, C	6	10	10	10	10	10	10	8	8	8	0.2	0.5	0.8	2	3.3	5.5	6	6	6	6
	8	10	10	10	10	10	10	8	8	8	0.2	0.4	0.7	1.7	2.8	4.5	6	6	6	6
	10	10	10	10	10	10	10	8	8	8	0.2	0.4	0.7	1.5	2.5	3.5	5	6	6	6
	16	10	10	10	10	10	10	8	8	8		0.7	1.5	2.5	3.5	5	6	6	6	
	20		10	10	10	10	10	8	8	8		1.3	2	2.9	4.1	6	6	6		
	25			10	10	10	15	10	8	8			1.8	2.6	3.5	5	6	6		
	32		**		10	10	10	8	8	8			1.8	2.6	3.5	5	6	6		
	40					10	10	8	8	8			2.2	3	4	6	6			

** Limited or no selectivity at all possible in the overload range (thermal tripping)

The above values require that, in the case of multi-phase installations, that the last cb be feed from above.

Index

Selection tables of MCBs SH 200 series

SH 200 T-B	3/2
SH 200 T-C	3/4
SH 200 L-B	3/6
SH 200 L-C	3/8
SH 200 B	3/10
SH 200 C	3/12

Selection tables of RCCBs FH 200 series

FH 200	3/14
--------------	------

Selection tables of RCBOs DS9 series

DS9	3/15
-----------	------

Selection tables of busbars

Busbars	3/16
---------------	------

Selection tables of MDRCs

E 200i switches	3/17
E 232 staircase lighting time delay switches	3/18
LSS 1/2 load shedding switches	3/18
TM/TS bell transformers	3/18
SM/RM bells and buzzers	3/18
DTS digital time switches	3/18
E 259 installation relays	3/18
E 250 latching relays	3/18
OVR surge protection devices	3/18

MCBs SH 200 series T

3000

B

SH 200 T B characteristic

Function: protection and control of the circuits against overloads and short-circuits; protection for people and big-length cables in TN and IT systems.

Applications: buildings, both residential and commercial

Standard: IEC/EN 60898

I_{cn}=3kA

No. of poles	rated current I _n A	order details		bbn 40 16779 EAN	price 1 piece	price group	w'ght 1 pc. kg	pack. unit pc.
		type code	order code					
1	6	SH 201 T-B 6	2CDS 231 001 R0065	63192 1			0.125	10
	10	SH 201 T-B 10	2CDS 231 001 R0105	63195 2			0.125	10
	13	SH 201 T-B 13	2CDS 231 001 R0135	63197 6			0.125	10
	16	SH 201 T-B 16	2CDS 231 001 R0165	63199 0			0.125	10
	20	SH 201 T-B 20	2CDS 231 001 R0205	63201 0			0.125	10
	25	SH 201 T-B 25	2CDS 231 001 R0255	63203 4			0.125	10
	32	SH 201 T-B 32	2CDS 231 001 R0325	63205 8			0.125	10
2	6	SH 202 T-B 6	2CDS 232 001 R0065	63226 3			0.25	5
	10	SH 202 T-B 10	2CDS 232 001 R0105	63229 4			0.25	5
	13	SH 202 T-B 13	2CDS 232 001 R0135	63231 7			0.25	5
	16	SH 202 T-B 16	2CDS 232 001 R0165	63233 1			0.25	5
	20	SH 202 T-B 20	2CDS 232 001 R0205	63235 5			0.25	5
	25	SH 202 T-B 25	2CDS 232 001 R0255	63237 9			0.25	5
	32	SH 202 T-B 32	2CDS 232 001 R0325	63239 3			0.25	5
3	6	SH 203 T-B 6	2CDS 233 001 R0065	63243 0			0.375	1
	10	SH 203 T-B 10	2CDS 233 001 R0105	63246 1			0.375	1
	13	SH 203 T-B 13	2CDS 233 001 R0135	63248 5			0.375	1
	16	SH 203 T-B 16	2CDS 233 001 R0165	63250 8			0.375	1
	20	SH 203 T-B 20	2CDS 233 001 R0205	63252 2			0.375	1
	25	SH 203 T-B 25	2CDS 233 001 R0255	63254 6			0.375	1
	32	SH 203 T-B 32	2CDS 233 001 R0325	63256 0			0.375	1
4	6	SH 204 T-B 6	2CDS 234 001 R0065	63277 5			0.5	1
	10	SH 204 T-B 10	2CDS 234 001 R0105	63280 5			0.5	1
	13	SH 204 T-B 13	2CDS 234 001 R0135	63282 9			0.5	1
	16	SH 204 T-B 16	2CDS 234 001 R0165	63284 3			0.5	1
	20	SH 204 T-B 20	2CDS 234 001 R0205	63286 7			0.5	1
	25	SH 204 T-B 25	2CDS 234 001 R0255	63288 1			0.5	1
	32	SH 204 T-B 32	2CDS 234 001 R0325	63290 4			0.5	1
40	SH 204 T-B 40	2CDS 234 001 R0405	63292 8			0.5	1	

① U_{Bmax} 125 V ∴ with 2 poles connected in series

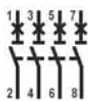

MCBs SH 200 series T

3000

B



With disconnecting neutral NA

No. of poles	rated current I _n A	order details		bbn 40 16779 EAN	price 1 piece	price group	w'ght 1 pc. kg	pack. unit pc.
		type code	order code					
1 + NA	6	SH 201 T-B 6 NA	2CDS 231 103 R0065	63209 6			0.25	5
	10	SH 201 T-B 10 NA	2CDS 231 103 R0105	63212 6			0.25	5
	13	SH 201 T-B 13 NA	2CDS 231 103 R0135	63214 0			0.25	5
	16	SH 201 T-B 16 NA	2CDS 231 103 R0165	63216 4			0.25	5
	20	SH 201 T-B 20 NA	2CDS 231 103 R0205	63218 8			0.25	5
	25	SH 201 T-B 25 NA	2CDS 231 103 R0255	63220 1			0.25	5
	32	SH 201 T-B 32 NA	2CDS 231 103 R0325	63222 5			0.25	5
U _{Bmax} 440 V ~ 60 V ∴	40	SH 201 T-B 40 NA	2CDS 231 103 R0405	63224 9			0.25	5
	<hr/>							
3 + NA	6	SH 203 T-B 6 NA	2CDS 233 103 R0065	63260 7			0.5	1
	10	SH 203 T-B 10 NA	2CDS 233 103 R0105	63263 8			0.5	1
	13	SH 203 T-B 13 NA	2CDS 233 103 R0135	63265 2			0.5	1
	16	SH 203 T-B 16 NA	2CDS 233 103 R0165	63267 6			0.5	1
	20	SH 203 T-B 20 NA	2CDS 233 103 R0205	63269 0			0.5	1
	25	SH 203 T-B 25 NA	2CDS 233 103 R0255	63271 3			0.5	1
	32	SH 203 T-B 32 NA	2CDS 233 103 R0325	63273 7			0.5	1
U _{Bmax} 440 V ~	40	SH 203 T-B 40 NA	2CDS 233 103 R0405	63275 1			0.5	1

3

MCBs SH 200 series T

3000

C

SH 200 T C characteristic

Function: protection and control of the circuits against overloads and short-circuits; protection for resistive and inductive loads with low inrush current.

Applications: buildings, both residential and commercial

Standard: IEC/EN 60898

I_{cn}=3kA

No. of poles	rated current I _n A	order details		bbn 40 16779 EAN	price 1 piece	price group	w'ght 1 pc. kg	pack. unit pc.
		type code	order code					
1	6	SH 201 T-C 6	2CDS 231 001 R0064	63191 4			0.125	10
	8	SH 201 T-C 8	2CDS 231 001 R0084	63193 8			0.125	10
	10	SH 201 T-C 10	2CDS 231 001 R0104	63194 5			0.125	10
	13	SH 201 T-C 13	2CDS 231 001 R0134	63196 9			0.125	10
	16	SH 201 T-C 16	2CDS 231 001 R0164	63198 3			0.125	10
	20	SH 201 T-C 20	2CDS 231 001 R0204	63200 3			0.125	10
	25	SH 201 T-C 25	2CDS 231 001 R0254	63202 7			0.125	10
	32	SH 201 T-C 32	2CDS 231 001 R0324	63204 1			0.125	10
	40	SH 201 T-C 40	2CDS 231 001 R0404	63206 5			0.125	10
	2	6	SH 202 T-C 6	2CDS 232 001 R0064	63225 6			0.25
8		SH 202 T-C 8	2CDS 232 001 R0084	63227 0			0.25	5
10		SH 202 T-C 10	2CDS 232 001 R0104	63228 7			0.25	5
13		SH 202 T-C 13	2CDS 232 001 R0134	63230 0			0.25	5
16		SH 202 T-C 16	2CDS 232 001 R0164	63232 4			0.25	5
20		SH 202 T-C 20	2CDS 232 001 R0204	63234 8			0.25	5
25		SH 202 T-C 25	2CDS 232 001 R0254	63236 2			0.25	5
32		SH 202 T-C 32	2CDS 232 001 R0324	63238 6			0.25	5
40		SH 202 T-C 40	2CDS 232 001 R0404	63240 9			0.25	5
3		6	SH 203 T-C 6	2CDS 233 001 R0064	63242 3			0.375
	8	SH 203 T-C 8	2CDS 233 001 R0084	63244 7			0.375	1
	10	SH 203 T-C 10	2CDS 233 001 R0104	63245 4			0.375	1
	13	SH 203 T-C 13	2CDS 233 001 R0134	63247 8			0.375	1
	16	SH 203 T-C 16	2CDS 233 001 R0164	63249 2			0.375	1
	20	SH 203 T-C 20	2CDS 233 001 R0204	63251 5			0.375	1
	25	SH 203 T-C 25	2CDS 233 001 R0254	63253 9			0.375	1
	32	SH 203 T-C 32	2CDS 233 001 R0324	63255 3			0.375	1
	40	SH 203 T-C 40	2CDS 233 001 R0404	63257 7			0.375	1
	4	6	SH 204 T-C 6	2CDS 234 001 R0064	63276 8			0.5
8		SH 204 T-C 8	2CDS 234 001 R0084	63278 2			0.5	1
10		SH 204 T-C 10	2CDS 234 001 R0104	63279 9			0.5	1
13		SH 204 T-C 13	2CDS 234 001 R0134	63281 2			0.5	1
16		SH 204 T-C 16	2CDS 234 001 R0164	63283 6			0.5	1
20		SH 204 T-C 20	2CDS 234 001 R0204	63285 0			0.5	1
25		SH 204 T-C 25	2CDS 234 001 R0254	63287 4			0.5	1
32		SH 204 T-C 32	2CDS 234 001 R0324	63289 8			0.5	1
40		SH 204 T-C 40	2CDS 234 001 R0404	63291 1			0.5	1

① U_{Bmax} 125 V ... with 2 poles connected in series

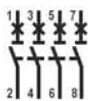

3

MCBs SH 200 series T

3000

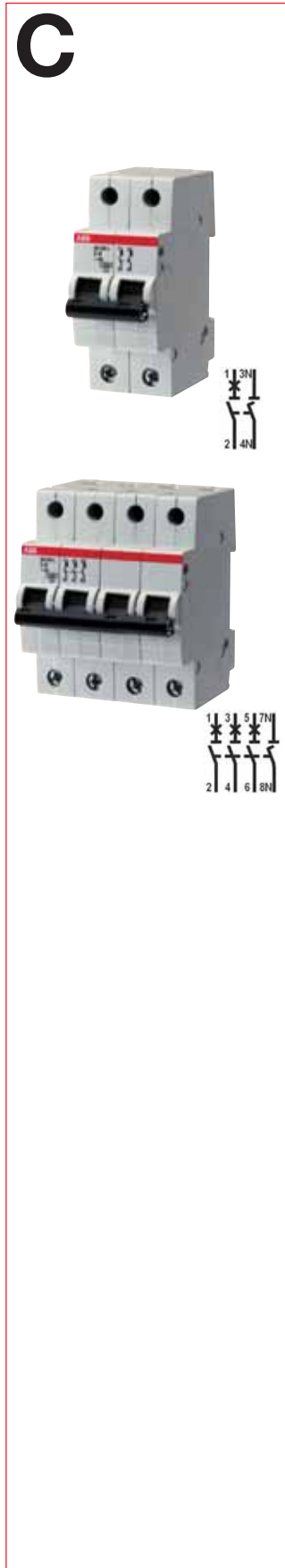

With disconnecting neutral NA

No. of poles	rated current I _n A	order details		bbn EAN	price 1 piece	price group	w/ght 1 pc. kg	pack. unit pc.	
		type code	order code						
1 + NA	6	SH 201 T-C 6 NA	2CDS 231 103 R0064	63208 9			0.25	5	
	8	SH 201 T-C 8 NA	2CDS 231 103 R0084	63210 2			0.25	5	
	10	SH 201 T-C 10 NA	2CDS 231 103 R0104	63211 9			0.25	5	
	13	SH 201 T-C 13 NA	2CDS 231 103 R0134	63213 3			0.25	5	
	16	SH 201 T-C 16 NA	2CDS 231 103 R0164	63215 7			0.25	5	
	20	SH 201 T-C 20 NA	2CDS 231 103 R0204	63217 1			0.25	5	
	25	SH 201 T-C 25 NA	2CDS 231 103 R0254	63219 5			0.25	5	
	32	SH 201 T-C 32 NA	2CDS 231 103 R0324	63221 8			0.25	5	
U _{Bmax} 440 V ~ 60 V ...	40	SH 201 T-C 40 NA	2CDS 231 103 R0404	63223 2			0.25	5	
	<hr/>								
3 + NA	6	SH 203 T-C 6 NA	2CDS 233 103 R0064	63259 1			0.5	1	
	8	SH 203 T-C 8 NA	2CDS 233 103 R0084	63261 4			0.5	1	
	10	SH 203 T-C 10 NA	2CDS 233 103 R0104	63262 1			0.5	1	
	13	SH 203 T-C 13 NA	2CDS 233 103 R0134	63264 5			0.5	1	
	16	SH 203 T-C 16 NA	2CDS 233 103 R0164	63266 9			0.5	1	
	20	SH 203 T-C 20 NA	2CDS 233 103 R0204	63268 3			0.5	1	
	25	SH 203 T-C 25 NA	2CDS 233 103 R0254	63270 6			0.5	1	
	32	SH 203 T-C 32 NA	2CDS 233 103 R0324	63272 0			0.5	1	
	U _{Bmax} 440 V ~	40	SH 203 T-C 40 NA	2CDS 233 103 R0404	63274 4			0.5	1

3

MCBs SH 200 series L

4500

B

SH 200 L B characteristic

Function: protection and control of the circuits against overloads and short-circuits; protection for people and big-length cables in TN and IT systems.

Applications: buildings, both residential and commercial

Standard: IEC/EN 60898

I_{cn}=4.5kA

No. of poles	rated current I _n A	order details		bbn 40 16779 EAN	price 1 piece	price group	w'ght 1 pc. kg	pack. unit pc.
		type code	order code					
1	6	SH 201 L-B 6	2CDS 241 001 R0065	63294 2			0.125	10
	10	SH 201 L-B 10	2CDS 241 001 R0105	63297 3			0.125	10
	13	SH 201 L-B 13	2CDS 241 001 R0135	63299 7			0.125	10
	16	SH 201 L-B 16	2CDS 241 001 R0165	63301 7			0.125	10
	20	SH 201 L-B 20	2CDS 241 001 R0205	63303 1			0.125	10
	25	SH 201 L-B 25	2CDS 241 001 R0255	63305 5			0.125	10
	32	SH 201 L-B 32	2CDS 241 001 R0325	63307 9			0.125	10
	40	SH 201 L-B 40	2CDS 241 001 R0405	63309 3			0.125	10
2	6	SH 202 L-B 6	2CDS 242 001 R0065	63328 4			0.25	5
	10	SH 202 L-B 10	2CDS 242 001 R0105	63331 4			0.25	5
	13	SH 202 L-B 13	2CDS 242 001 R0135	63333 8			0.25	5
	16	SH 202 L-B 16	2CDS 242 001 R0165	63335 2			0.25	5
	20	SH 202 L-B 20	2CDS 242 001 R0205	63337 6			0.25	5
	25	SH 202 L-B 25	2CDS 242 001 R0255	63339 0			0.25	5
	32	SH 202 L-B 32	2CDS 242 001 R0325	63341 3			0.25	5
	40	SH 202 L-B 40	2CDS 242 001 R0405	63343 7			0.25	5
3	6	SH 203 L-B 6	2CDS 243 001 R0065	63345 1			0.375	1
	10	SH 203 L-B 10	2CDS 243 001 R0105	63348 2			0.375	1
	13	SH 203 L-B 13	2CDS 243 001 R0135	63350 5			0.375	1
	16	SH 203 L-B 16	2CDS 243 001 R0165	63352 9			0.375	1
	20	SH 203 L-B 20	2CDS 243 001 R0205	63354 3			0.375	1
	25	SH 203 L-B 25	2CDS 243 001 R0255	63356 7			0.375	1
	32	SH 203 L-B 32	2CDS 243 001 R0325	63358 1			0.375	1
	40	SH 203 L-B 40	2CDS 243 001 R0405	63360 4			0.375	1
4	6	SH 204 L-B 6	2CDS 244 001 R0065	63379 6			0.5	1
	10	SH 204 L-B 10	2CDS 244 001 R0105	63382 6			0.5	1
	13	SH 204 L-B 13	2CDS 244 001 R0135	63384 0			0.5	1
	16	SH 204 L-B 16	2CDS 244 001 R0165	63386 4			0.5	1
	20	SH 204 L-B 20	2CDS 244 001 R0205	63388 8			0.5	1
	25	SH 204 L-B 25	2CDS 244 001 R0255	63390 1			0.5	1
	32	SH 204 L-B 32	2CDS 244 001 R0325	63392 5			0.5	1
	40	SH 204 L-B 40	2CDS 244 001 R0405	63394 9			0.5	1

① U_{Bmax} 125 V ... with 2 poles connected in series

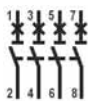

MCBs SH 200 series L

4500

B

With disconnecting neutral NA



No. of poles	rated current I _n A	order details		bbn 40 16779 EAN	price 1 piece	price group	w/ght 1 pc. kg	pack. unit pc.
		type code	order code					
1 + NA	6	SH 201 L-B 6 NA	2CDS 241 103 R0065	63311 6			0.25	5
	10	SH 201 L-B 10 NA	2CDS 241 103 R0105	63314 7			0.25	5
	13	SH 201 L-B 13 NA	2CDS 241 103 R0135	63316 1			0.25	5
	16	SH 201 L-B 16 NA	2CDS 241 103 R0165	63318 5			0.25	5
	20	SH 201 L-B 20 NA	2CDS 241 103 R0205	63320 8			0.25	5
	25	SH 201 L-B 25 NA	2CDS 241 103 R0255	63322 2			0.25	5
U _{Bmax} 440 V ~	32	SH 201 L-B 32 NA	2CDS 241 103 R0325	63324 6			0.25	5
	40	SH 201 L-B 40 NA	2CDS 241 103 R0405	63326 0			0.25	5
3 + NA	6	SH 203 L-B 6 NA	2CDS 243 103 R0065	63362 8			0.5	1
	10	SH 203 L-B 10 NA	2CDS 243 103 R0105	63365 9			0.5	1
	13	SH 203 L-B 13 NA	2CDS 243 103 R0135	63367 3			0.5	1
	16	SH 203 L-B 16 NA	2CDS 243 103 R0165	63369 7			0.5	1
	20	SH 203 L-B 20 NA	2CDS 243 103 R0205	63371 0			0.5	1
	25	SH 203 L-B 25 NA	2CDS 243 103 R0255	63373 4			0.5	1
U _{Bmax} 440 V ~	32	SH 203 L-B 32 NA	2CDS 243 103 R0325	63375 8			0.5	1
	40	SH 203 L-B 40 NA	2CDS 243 103 R0405	63377 2			0.5	1

3

MCBs SH 200 series L

C

SH 200 L C characteristic

Function: protection and control of the circuits against overloads and short-circuits; protection for resistive and inductive loads with low inrush current.

Applications: buildings, both residential and commercial

Standard: IEC/EN 60898

I_{cn}=4.5kA

No. of poles	rated current I _n A	order details		bbn 40 16779 EAN	price 1 piece	price group	w'ght 1 pc. kg	pack. unit pc.
		type code	order code					
1	6	SH 201 L-C 6	2CDS 241 001 R0064	63293 5			0.125	10
	8	SH 201 L-C 8	2CDS 241 001 R0084	63295 9			0.125	10
	10	SH 201 L-C 10	2CDS 241 001 R0104	63296 6			0.125	10
	13	SH 201 L-C 13	2CDS 241 001 R0134	63298 0			0.125	10
	16	SH 201 L-C 16	2CDS 241 001 R0164	63300 0			0.125	10
	20	SH 201 L-C 20	2CDS 241 001 R0204	63302 4			0.125	10
	25	SH 201 L-C 25	2CDS 241 001 R0254	63304 8			0.125	10
	32	SH 201 L-C 32	2CDS 241 001 R0324	63306 2			0.125	10
2	6	SH 202 L-C 6	2CDS 242 001 R0064	63327 7			0.25	5
	8	SH 202 L-C 8	2CDS 242 001 R0084	63329 1			0.25	5
	10	SH 202 L-C 10	2CDS 242 001 R0104	63330 7			0.25	5
	13	SH 202 L-C 13	2CDS 242 001 R0134	63332 1			0.25	5
	16	SH 202 L-C 16	2CDS 242 001 R0164	63334 5			0.25	5
	20	SH 202 L-C 20	2CDS 242 001 R0204	63336 9			0.25	5
	25	SH 202 L-C 25	2CDS 242 001 R0254	63338 3			0.25	5
	32	SH 202 L-C 32	2CDS 242 001 R0324	63340 6			0.25	5
3	6	SH 203 L-C 6	2CDS 243 001 R0064	63344 4			0.375	1
	8	SH 203 L-C 8	2CDS 243 001 R0084	63346 8			0.375	1
	10	SH 203 L-C 10	2CDS 243 001 R0104	63347 5			0.375	1
	13	SH 203 L-C 13	2CDS 243 001 R0134	63349 9			0.375	1
	16	SH 203 L-C 16	2CDS 243 001 R0164	63351 2			0.375	1
	20	SH 203 L-C 20	2CDS 243 001 R0204	63353 6			0.375	1
	25	SH 203 L-C 25	2CDS 243 001 R0254	63355 0			0.375	1
	32	SH 203 L-C 32	2CDS 243 001 R0324	63357 4			0.375	1
4	6	SH 204 L-C 6	2CDS 244 001 R0064	63378 9			0.5	1
	8	SH 204 L-C 8	2CDS 244 001 R0084	63380 2			0.5	1
	10	SH 204 L-C 10	2CDS 244 001 R0104	63381 9			0.5	1
	13	SH 204 L-C 13	2CDS 244 001 R0134	63383 3			0.5	1
	16	SH 204 L-C 16	2CDS 244 001 R0164	63385 7			0.5	1
	20	SH 204 L-C 20	2CDS 244 001 R0204	63387 1			0.5	1
	25	SH 204 L-C 25	2CDS 244 001 R0254	63389 5			0.5	1
	32	SH 204 L-C 32	2CDS 244 001 R0324	63391 8			0.5	1
① 40	SH 204 L-C 40	2CDS 244 001 R0404	63393 2			0.5	1	

① U_{Bmax} 125 V ∴ with 2 poles connected in series

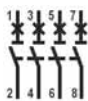

MCBs SH 200 series L

4500

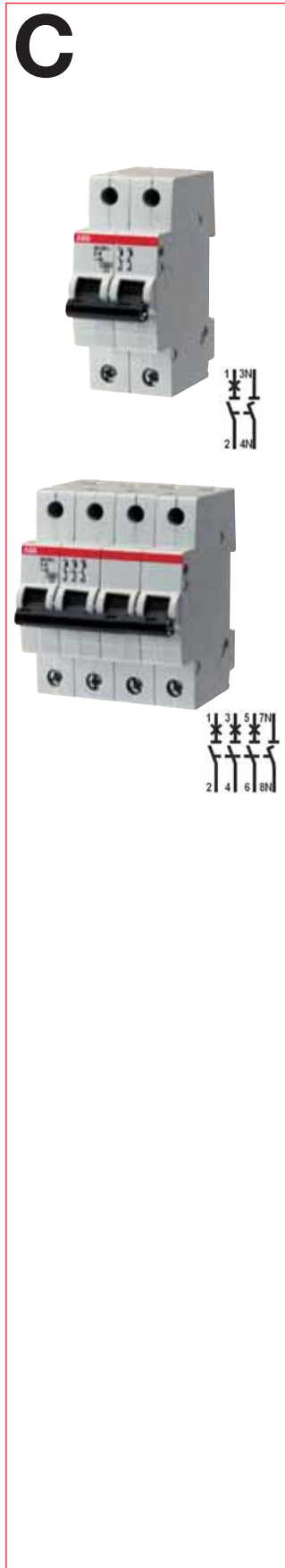

With disconnecting neutral NA

No. of poles	rated current I _n , A	order details		bbn 40 16779 EAN	price 1 piece	price group	w'ght 1 pc. kg	pack. unit pc.
		type code	order code					
1 + NA	6	SH 201 L-C 6 NA	2CDS 241 103 R0064	63310 9			0.25	5
	8	SH 201 L-C 8 NA	2CDS 241 103 R0084	63312 3			0.25	5
	10	SH 201 L-C 10 NA	2CDS 241 103 R0104	63313 0			0.25	5
	13	SH 201 L-C 13 NA	2CDS 241 103 R0134	63315 4			0.25	5
	16	SH 201 L-C 16 NA	2CDS 241 103 R0164	63317 8			0.25	5
	20	SH 201 L-C 20 NA	2CDS 241 103 R0204	63319 2			0.25	5
	25	SH 201 L-C 25 NA	2CDS 241 103 R0254	63321 5			0.25	5
	32	SH 201 L-C 32 NA	2CDS 241 103 R0324	63323 9			0.25	5
U _{Bmax} 440 V ~ 60 V ...	40	SH 201 L-C 40 NA	2CDS 241 103 R0404	63325 3			0.25	5
	<hr/>							
3 + NA	6	SH 203 L-C 6 NA	2CDS 243 103 R0064	63361 1			0.5	1
	8	SH 203 L-C 8 NA	2CDS 243 103 R0084	63363 5			0.5	1
	10	SH 203 L-C 10 NA	2CDS 243 103 R0104	63364 2			0.5	1
	13	SH 203 L-C 13 NA	2CDS 243 103 R0134	63366 6			0.5	1
	16	SH 203 L-C 16 NA	2CDS 243 103 R0164	63368 0			0.5	1
	20	SH 203 L-C 20 NA	2CDS 243 103 R0204	63370 3			0.5	1
	25	SH 203 L-C 25 NA	2CDS 243 103 R0254	63372 7			0.5	1
	32	SH 203 L-C 32 NA	2CDS 243 103 R0324	63374 1			0.5	1
U _{Bmax} 440 V ~	40	SH 203 L-C 40 NA	2CDS 243 103 R0404	63376 5			0.5	1

3

MCBs SH 200 series

6000

B

SH 200 B characteristic

Function: protection and control of the circuits against overloads and short-circuits; protection for people and big-length cables in TN and IT systems.

Applications: buildings, both residential and commercial

Standard: IEC/EN 60898

I_{cn}=6kA

No. of poles	rated current I _n A	order details		bbn 40 16779 EAN	price 1 piece	price group	w'ght 1 pc. kg	pack. unit pc.
		type code	order code					
1	6	SH 201-B 6	2CDS 211 001 R0065	63058 0			0.125	10
	10	SH 201-B 10	2CDS 211 001 R0105	63061 0			0.125	10
	13	SH 201-B 13	2CDS 211 001 R0135	63063 4			0.125	10
	16	SH 201-B 16	2CDS 211 001 R0165	63065 8			0.125	10
	20	SH 201-B 20	2CDS 211 001 R0205	63067 2			0.125	10
	25	SH 201-B 25	2CDS 211 001 R0255	63069 6			0.125	10
	32	SH 201-B 32	2CDS 211 001 R0325	63071 9			0.125	10
U _{Bmax} 440 V ~ 60 V ∴	40	SH 201-B 40	2CDS 211 001 R0405	63073 3			0.125	10
	<hr/>							
2	6	SH 202-B 6	2CDS 212 001 R0065	63104 4			0.25	5
	10	SH 202-B 10	2CDS 212 001 R0105	63107 5			0.25	5
	13	SH 202-B 13	2CDS 212 001 R0135	63109 9			0.25	5
	16	SH 202-B 16	2CDS 212 001 R0165	63111 2			0.25	5
	20	SH 202-B 20	2CDS 212 001 R0205	63113 6			0.25	5
	25	SH 202-B 25	2CDS 212 001 R0255	63115 0			0.25	5
	32	SH 202-B 32	2CDS 212 001 R0325	63117 4			0.25	5
U _{Bmax} 440 V ~ 125 V ∴ ①	40	SH 202-B 40	2CDS 212 001 R0405	63119 8			0.25	5
	<hr/>							
3	6	SH 203-B 6	2CDS 213 001 R0065	63127 3			0.375	1
	10	SH 203-B 10	2CDS 213 001 R0105	63130 3			0.375	1
	13	SH 203-B 13	2CDS 213 001 R0135	63132 7			0.375	1
	16	SH 203-B 16	2CDS 213 001 R0165	63134 1			0.375	1
	20	SH 203-B 20	2CDS 213 001 R0205	63136 5			0.375	1
	25	SH 203-B 25	2CDS 213 001 R0255	63138 9			0.375	1
	32	SH 203-B 32	2CDS 213 001 R0325	63140 2			0.375	1
U _{Bmax} 440 V ~ 40	SH 203-B 40	2CDS 213 001 R0405	63142 6			0.375	1	
	<hr/>							
4	6	SH 204-B 6	2CDS 214 001 R0065	63173 0			0.5	1
	10	SH 204-B 10	2CDS 214 001 R0105	63176 1			0.5	1
	13	SH 204-B 13	2CDS 214 001 R0135	63178 5			0.5	1
	16	SH 204-B 16	2CDS 214 001 R0165	63180 8			0.5	1
	20	SH 204-B 20	2CDS 214 001 R0205	63182 2			0.5	1
	25	SH 204-B 25	2CDS 214 001 R0255	63184 6			0.5	1
	32	SH 204-B 32	2CDS 214 001 R0325	63186 0			0.5	1
U _{Bmax} 440 V ~ 125 V ∴ ①	40	SH 204-B 40	2CDS 214 001 R0405	63188 4			0.5	1

① U_{Bmax} 125 V ∴ with 2 poles connected in series

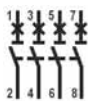

MCBs SH 200 series

6000

B



With disconnecting neutral NA

No. of poles	rated current I_n A	order details		bbn 40 16779 EAN	price 1 piece	price group	w'ght 1 pc. kg	pack. unit pc.
		type code	order code					
1 + NA	6	SH 201-B 6 NA	2CDS 211 103 R0065	63081 8			0.25	5
	10	SH 201-B 10 NA	2CDS 211 103 R0105	63084 9			0.25	5
	13	SH 201-B 13 NA	2CDS 211 103 R0135	63086 3			0.25	5
	16	SH 201-B 16 NA	2CDS 211 103 R0165	63088 7			0.25	5
	20	SH 201-B 20 NA	2CDS 211 103 R0205	63090 0			0.25	5
	25	SH 201-B 25 NA	2CDS 211 103 R0255	63092 4			0.25	5
	32	SH 201-B 32 NA	2CDS 211 103 R0325	63094 8			0.25	5
60 V ...	40	SH 201-B 40 NA	2CDS 211 103 R0405	63096 2			0.25	5
3 + NA	6	SH 203-B 6 NA	2CDS 213 103 R0065	63150 1			0.5	1
	10	SH 203-B 10 NA	2CDS 213 103 R0105	63153 2			0.5	1
	13	SH 203-B 13 NA	2CDS 213 103 R0135	63155 6			0.5	1
	16	SH 203-B 16 NA	2CDS 213 103 R0165	63157 0			0.5	1
	20	SH 203-B 20 NA	2CDS 213 103 R0205	63159 4			0.5	1
	25	SH 203-B 25 NA	2CDS 213 103 R0255	63161 7			0.5	1
	32	SH 203-B 32 NA	2CDS 213 103 R0325	63163 1			0.5	1
60 V ...	40	SH 203-B 40 NA	2CDS 213 103 R0405	63165 5			0.5	1

3

MCBs SH 200 series

6000

C

SH 200 C characteristic

Function: protection and control of the circuits against overloads and short-circuits; protection for resistive and inductive loads with low inrush current.

Applications: buildings, both residential and commercial

Standard: IEC/EN 60898

I_{cn}=6kA

No. of poles	rated current I _n A	order details		bbn 40 16779 EAN	price 1 piece	price group	w'ght 1 pc. kg	pack. unit pc.
		type code	order code					
1	6	SH 201-C 6	2CDS 211 001 R0064	63057 3			0.125	10
	8	SH 201-C 8	2CDS 211 001 R0084	63059 7			0.125	10
	10	SH 201-C 10	2CDS 211 001 R0104	63060 3			0.125	10
	13	SH 201-C 13	2CDS 211 001 R0134	63062 7			0.125	10
	16	SH 201-C 16	2CDS 211 001 R0164	63064 1			0.125	10
	20	SH 201-C 20	2CDS 211 001 R0204	63066 5			0.125	10
	25	SH 201-C 25	2CDS 211 001 R0254	63068 9			0.125	10
	32	SH 201-C 32	2CDS 211 001 R0324	63070 2			0.125	10
	40	SH 201-C 40	2CDS 211 001 R0404	63072 6			0.125	10
	U _{Bmax} 440 V ~ 60 V ...							
2	6	SH 202-C 6	2CDS 212 001 R0064	63103 7			0.25	5
	8	SH 202-C 8	2CDS 212 001 R0084	63105 1			0.25	5
	10	SH 202-C 10	2CDS 212 001 R0104	63106 8			0.25	5
	13	SH 202-C 13	2CDS 212 001 R0134	63108 2			0.25	5
	16	SH 202-C 16	2CDS 212 001 R0164	63110 5			0.25	5
	20	SH 202-C 20	2CDS 212 001 R0204	63112 9			0.25	5
	25	SH 202-C 25	2CDS 212 001 R0254	63114 3			0.25	5
	32	SH 202-C 32	2CDS 212 001 R0324	63116 7			0.25	5
	40	SH 202-C 40	2CDS 212 001 R0404	63118 1			0.25	5
	U _{Bmax} 440 V ~ 125 V ...							
3	6	SH 203-C 6	2CDS 213 001 R0064	63126 6			0.375	1
	8	SH 203-C 8	2CDS 213 001 R0084	63128 0			0.375	1
	10	SH 203-C 10	2CDS 213 001 R0104	63129 7			0.375	1
	13	SH 203-C 13	2CDS 213 001 R0134	63131 0			0.375	1
	16	SH 203-C 16	2CDS 213 001 R0164	63133 4			0.375	1
	20	SH 203-C 20	2CDS 213 001 R0204	63135 8			0.375	1
	25	SH 203-C 25	2CDS 213 001 R0254	63137 2			0.375	1
	32	SH 203-C 32	2CDS 213 001 R0324	63139 6			0.375	1
	40	SH 203-C 40	2CDS 213 001 R0404	63141 9			0.375	1
	U _{Bmax} 440 V ~							
4	6	SH 204-C 6	2CDS 214 001 R0064	63172 3			0.5	1
	8	SH 204-C 8	2CDS 214 001 R0084	63174 7			0.5	1
	10	SH 204-C 10	2CDS 214 001 R0104	63175 4			0.5	1
	13	SH 204-C 13	2CDS 214 001 R0134	63177 8			0.5	1
	16	SH 204-C 16	2CDS 214 001 R0164	63179 2			0.5	1
	20	SH 204-C 20	2CDS 214 001 R0204	63181 5			0.5	1
	25	SH 204-C 25	2CDS 214 001 R0254	63183 9			0.5	1
	32	SH 204-C 32	2CDS 214 001 R0324	63185 3			0.5	1
	40	SH 204-C 40	2CDS 214 001 R0404	63187 7			0.5	1
	U _{Bmax} 440 V ~ 125 V ...							

① U_{Bmax} 125 V ... with 2 poles connected in series



MCBs SH 200 series

6000

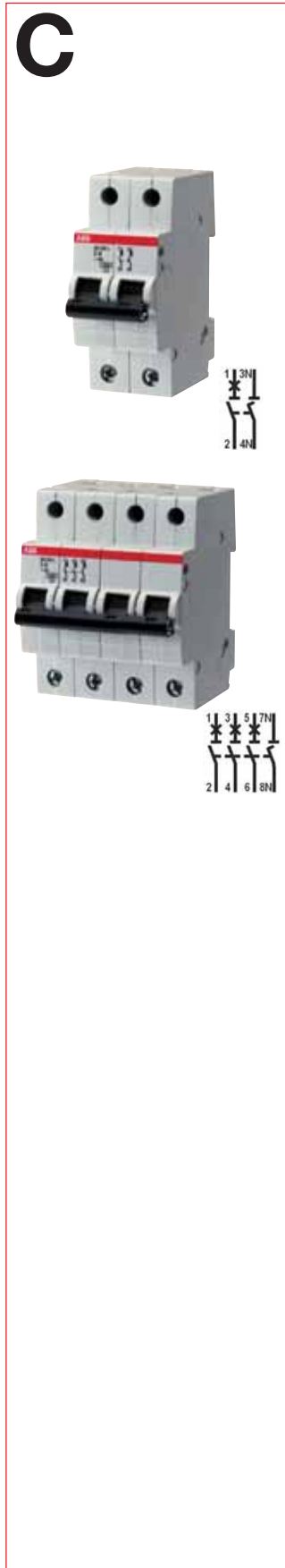

With disconnecting neutral NA

No. of poles	rated current I_n A	order details		bbn 40 16779 EAN	price 1 piece	price group	w'ght 1 pc. kg	pack. unit pc.	
		type code	order code						
1 + NA	6	SH 201-C 6 NA	2CDS 211 103 R0064	63080 1			0.25	5	
	8	SH 201-C 8 NA	2CDS 211 103 R0084	63082 5			0.25	5	
	10	SH 201-C 10 NA	2CDS 211 103 R0104	63083 2			0.25	5	
	13	SH 201-C 13 NA	2CDS 211 103 R0134	63085 6			0.25	5	
	16	SH 201-C 16 NA	2CDS 211 103 R0164	63087 0			0.25	5	
	20	SH 201-C 20 NA	2CDS 211 103 R0204	63089 4			0.25	5	
	25	SH 201-C 25 NA	2CDS 211 103 R0254	63091 7			0.25	5	
U_{Bmax} 440 V ~	32	SH 201-C 32 NA	2CDS 211 103 R0324	63093 1			0.25	5	
	40	SH 201-C 40 NA	2CDS 211 103 R0404	63095 5			0.25	5	
3 + NA	6	SH 203-C 6 NA	2CDS 213 103 R0064	63149 5			0.5	1	
	8	SH 203-C 8 NA	2CDS 213 103 R0084	63151 8			0.5	1	
	10	SH 203-C 10 NA	2CDS 213 103 R0104	63152 5			0.5	1	
	13	SH 203-C 13 NA	2CDS 213 103 R0134	63154 9			0.5	1	
	16	SH 203-C 16 NA	2CDS 213 103 R0164	63156 3			0.5	1	
	20	SH 203-C 20 NA	2CDS 213 103 R0204	63158 7			0.5	1	
	25	SH 203-C 25 NA	2CDS 213 103 R0254	63160 0			0.5	1	
	U_{Bmax} 440 V ~	32	SH 203-C 32 NA	2CDS 213 103 R0324	63162 4			0.5	1
		40	SH 203-C 40 NA	2CDS 213 103 R0404	63164 8			0.5	1

3

RCCBs FH 200 series

AC  and A  type

AC

FH 200 AC type

Function: protection against the effects of sinusoidal alternating earth fault currents; protection against indirect contacts and additional protection against direct (with $I_{\Delta n}=30\text{mA}$) contacts; command and isolation of resistive and inductive circuits.

Application: buildings, both residential and commercial

Standard: IEC/EN 61008

Marking: according to IEC 61008

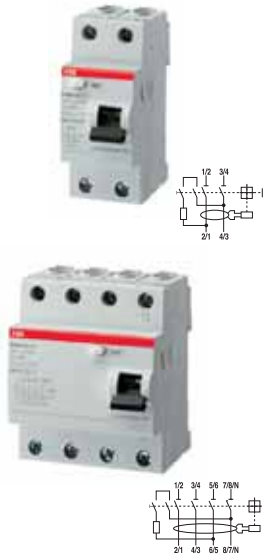

No. of poles	nominal fault current $I_{\Delta n}$ mA	nominal current I_n A	order details		bbn 80 12542 EAN	price 1 piece	price group	w'ght 1 pc. kg	pack unit pc.
			type code	order code					
2	30	25	FH202 AC-25/0.03	2CSF202006R1250	894209			0.200	1/6
		40	FH202 AC-40/0.03	2CSF202006R1400	894308			0.200	1/6
		63	FH202 AC-63/0.03	2CSF202006R1630	894407			0.200	1/6
	100	25	FH202 AC-25/0.1	2CSF202006R2250	894506			0.200	1/6
		40	FH202 AC-40/0.1	2CSF202006R2400	894605			0.200	1/6
		63	FH202 AC-63/0.1	2CSF202006R2630	894704			0.200	1/6
	300	25	FH202 AC-25/0.3	2CSF202006R3250	894803			0.200	1/6
		40	FH202 AC-40/0.3	2CSF202006R3400	894902			0.200	1/6
		63	FH202 AC-63/0.3	2CSF202006R3630	895008			0.200	1/6
4	30	25	FH204 AC-25/0.03	2CSF204006R1250	895107			0.350	1/3
		40	FH204 AC-40/0.03	2CSF204006R1400	895206			0.350	1/3
		63	FH204 AC-63/0.03	2CSF204006R1630	895305			0.350	1/3
	100	25	FH204 AC-25/0.1	2CSF204006R2250	895404			0.350	1/3
		40	FH204 AC-40/0.1	2CSF204006R2400	895503			0.350	1/3
		63	FH204 AC-63/0.1	2CSF204006R2630	895602			0.350	1/3
	300	25	FH204 AC-25/0.3	2CSF204006R3250	895701			0.350	1/3
		40	FH204 AC-40/0.3	2CSF204006R3400	895800			0.350	1/3
		63	FH204 AC-63/0.3	2CSF204006R3630	895909			0.350	1/3

A

FH 200 A type

Function: protection against the effects of sinusoidal alternating and direct pulsating earth fault currents; protection against indirect contacts and additional protection against direct (with $I_{\Delta n}=30\text{mA}$) contacts; command and isolation of resistive and inductive circuits.

Application: buildings, both residential and commercial

Standard: IEC/EN 61008

Marking: according to EN 61008



No. of poles	nominal fault current $I_{\Delta n}$ mA	nominal current I_n A	order details		bbn 80 12542 EAN	price 1 piece	price group	w'ght 1 pc. kg	pack unit pc.
			type code	order code					
2	30	25	FH202 A-25/0.03	2CSF202102R1250	892403			0.200	1/6
		40	FH202 A-40/0.03	2CSF202102R1400	892502			0.200	1/6
		63	FH202 A-63/0.03	2CSF202102R1630	892601			0.200	1/6
4	30	25	FH204 A-25/0.03	2CSF204102R1250	892700			0.350	1/3
		40	FH204 A-40/0.03	2CSF204102R1400	892809			0.350	1/3
		63	FH204 A-63/0.03	2CSF204102R1630	892908			0.350	1/3

RCBOs series

DS 941 and DS951, B and C characteristics

Function: protection against both overload and short circuit currents and earth fault currents; additional protection against direct contact (thanks to $I\Delta n=30mA$)

Application: buildings, both residential and commercial



No. of poles	type/class	nominal fault current $I\Delta n$ mA	nominal current I_n A	order details type code	order code	bbn 80 12542 EAN	price 1 piece	price group	w'ght 1 pc. kg	pack. unit pc.
--------------	------------	--------------------------------------	-------------------------	----------------------------	------------	------------------------	------------------	----------------	----------------------	----------------------

RCBOs DS 941, $I_{cn}= 4.5kA$, B characteristics

1P+N	AC	30	10	DS 941 B10-30MA AC	16020015	403104			0.200	1/5
			16	DS 941 B16-30MA AC	16020023	403203			0.200	1/5
			20	DS 941 B20-30MA AC	16020031	403302			0.200	1/5
			25	DS 941 B25-30MA AC	16020049	403401			0.200	1/5

RCBOs DS 941, $I_{cn}= 4.5kA$, C characteristic

1P+N	AC	30	10	DS 941 C10-30MA AC	16020403	406600			0.200	1/5
			16	DS 941 C16-30MA AC	16020411	406709			0.200	1/5
			20	DS 941 C20-30MA AC	16020429	406808			0.200	1/5
			25	DS 941 C25-30MA AC	16020437	406907			0.200	1/5

RCBOs DS 951, $I_{cn}=6kA$, B characteristic

1P+N	AC	30	10	DS 951 B10-30MA AC	16021013	410102			0.200	1/5
			16	DS 951 B16-30MA AC	16021021	410201			0.200	1/5
			20	DS 951 B20-30MA AC	16021039	410300			0.200	1/5
			25	DS 951 B25-30MA AC	16021047	410409			0.200	1/5

RCBOs DS 951, $I_{cn}= 6kA$, C characteristic

1P+N	AC	30	10	DS 951 C10-30MA AC	16021369	413608			0.200	1/5
			16	DS 951 C16-30MA AC	16021377	413707			0.200	1/5
			20	DS 951 C20-30MA AC	16021385	413806			0.200	1/5
			25	DS 951 C25-30MA AC	16021393	413905			0.200	1/5

Note: for more information about these products and to know the complete range, see the technical catalogue

Type	Order Code	bbn 4016779 EAN	Pins	mm ²	Phase sequence	End caps	Pack unit pcs.
------	------------	-----------------------	------	-----------------	----------------	----------	-------------------

Busbars

PSH 1/12	2CDL110001R1012	651868	12	10	L1-L1...	PSH-END 1.1	50
PSH 1/60	2CDL110001R1060	651875	60	10	L1-L1...	PSH-END 1.1	20
PSH 2/12	2CDL120001R1012	651882	12	10	L1-L2-L1...	incl.	50
PSH 2/58	2CDL120001R1058	651899	58	10	L1-L2-L1...	PSH-END	10
PSH 3/12	2CDL130001R1012	651905	12	10	L1-L2-L3-L1...	incl.	50
PSH 3/60	2CDL130001R1060	651912	60	10	L1-L2-L3-L1...	PSH-END	10
PSH 4/12	2CDL140001R1012	651929	12	10	L1-L2-L3-N-L1...	incl.	30
PSH 4/60	2CDL140001R1060	651936	60	10	L1-L2-L3-N-L1...	PSH-END 1	50

End caps

PSH-END 1.1	2CDL100011R0011	653169					50
PSH-END	2CDL100001R0002	653176					50
PSH-END 1	2CDL200110R0001	653183					50



E 200 switches

Isolator for panel installation onto DIN rail acc. to DIN EN 60715

- Mounting depth: 70mm
- Mounting width: per pole = 17.5mm = 1 module
- Colour: grey, RAL 7035
- Colour of switch lever: red RAL 3000 (r); grey RAL 7000 (g)

Special features

- Captive screws with recessed/slotted head, Pozidriv size 2
- Integrated lay-on edge for labeling system ILS
- Locking device as accessories for unauthorized ON/OFF
- Approval: VDE, CCC

No. of poles	rated voltage VAC	power loss W	order details		bbn 4016779 EAN	price 1 piece	price group	w'ght 1 pc. kg	pack. unit pc.
			type code	order code					

Rated current = 16A

1NO	230V	0.15	E201/16g	2CDE281001R1016	645614			0.095	10
1NO	230V	0.15	E201/16r	2CDE281001R0016	645621			0.095	10
2NO	400V	0.30	E202/16g	2CDE282001R1016	645799			0.190	5
2NO	400V	0.30	E202/16r	2CDE282001R0016	645805			0.190	5
3NO	400V	0.45	E203/16g	2CDE283001R1016	645973			0.290	3
3NO	400V	0.45	E203/16r	2CDE283001R0016	645980			0.290	3
4NO	400V	0.60	E204/16g	2CDE284001R1016	646154			0.390	2
4NO	400V	0.60	E204/16r	2CDE284001R0016	646161			0.390	2

Technical data

Switching capacity	1.25 x I _n ; 1.1 x U _n ; cosφ = 0..3 acc. to DIN VDE 0632 AC22-A/AC23-A acc. to VDE 0660 part 107, DIN EN 60947-3 resp. IEC 947-3 DC21-B for applications up to 60 V DC
Positiv opening	acc. to DIN VDE 0113
Short-circuit withstand capacity	24 kA _{eff} in series with NH 00 100 A gL-gG; 10 kA _{eff} in series with NH 00 125 A gL-gG
Rated voltage	230/400 V AC; 50/60 Hz
Surge withstand capability U_{imp}	4 kV acc. to EN 60947-1
Ambient temperature	-25 °C to +55 °C
Storage temperature	-40 °C to +70 °C
Climatic resistance	constant climate 23/83, 40/93, 55/20 [°C/RH] alternating climate 25/95 - 40/93 [°C/RH]
Mounting position	optional
Degree of protection	IP10 B (with add. task), IP40 in panelboard
Mechanical endurance	20000 switching cycles
Electrical endurance	1000 switching cycles
Min. voltage	12 V AC/DC at 0.1 VA
Min. contact loading	24 V/4 mA
Wire range	2.5 to 50 mm ²
Torque	5 Nm

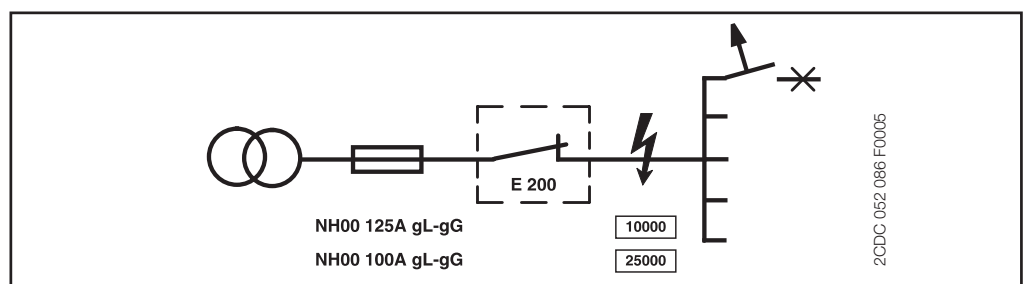



2CDC 051 002 F0004

No. of poles	rated voltage VAC	power loss W	order details type code	order code	bbn 4016779 EAN	price 1 piece	price group	w'ght 1 pc. kg	pack. unit pc.
--------------	-------------------	--------------	-------------------------	------------	-----------------	---------------	-------------	----------------	----------------

Rated current = 25A

1NO	230V	0.30	E201/25g	2CDE281001R1025	645638			0.095	10
1NO	230V	0.30	E201/25r	2CDE281001R0025	645645			0.095	10
2NO	400V	0.60	E202/25g	2CDE282001R1025	645812			0.190	5
2NO	400V	0.60	E202/25r	2CDE282001R0025	645829			0.190	5
3NO	400V	0.90	E203/25g	2CDE283001R1025	645997			0.290	3
3NO	400V	0.90	E203/25r	2CDE283001R0025	646000			0.290	3
4NO	400V	1.20	E204/25g	2CDE284001R1025	646178			0.390	2
4NO	400V	1.20	E204/25r	2CDE284001R0025	646185			0.390	2

Rated current = 32A

1NO	230V	0.50	E201/32g	2CDE281001R1032	645652			0.095	10
1NO	230 V	0.50	E201/32r	2CDE281001R0032	645669			0.095	10
2NO	400V	0.95	E202/32g	2CDE282001R1032	645836			0.190	5
2NO	400V	0.95	E202/32r	2CDE282001R0032	645843			0.190	5
3NO	400V	1.40	E203/32g	2CDE283001R1032	646017			0.290	3
3NO	400V	1.40	E203/32r	2CDE283001R0032	646024			0.290	3
4NO	400V	1.90	E204/32g	2CDE284001R1032	646192			0.390	2
4NO	400V	1.90	E204/32r	2CDE284001R0032	646208			0.390	2

Rated current = 40A

1NO	230V	0.70	E201/40g	2CDE281001R1040	645676			0.095	10
1NO	230V	0.70	E201/40r	2CDE281001R0040	645683			0.095	10
2NO	400 V	1.40	E202/40g	2CDE282001R1040	645850			0.190	5
2NO	400V	1.40	E202/40r	2CDE282001R0040	645867			0.190	5
3NO	400V	2.10	E203/40g	2CDE283001R1040	646031			0.290	3
3NO	400V	2.10	E203/40r	2CDE283001R0040	646048			0.290	3
4NO	400V	2.80	E204/40g	2CDE284001R1040	646215			0.390	2
4NO	400V	2.80	E204/40r	2CDE284001R0040	646222			0.390	2

Rated current = 45A

1NO	230V	0.90	E201/45g	2CDE281001R1045	645690			0.095	10
1NO	230V	0.90	E201/45r	2CDE281001R0045	645706			0.095	10
2NO	400 V	1.80	E202/45g	2CDE282001R1045	645874			0.190	5
2NO	400V	1.80	E202/45r	2CDE282001R0045	645881			0.190	5
3NO	400V	2.65	E203/45g	2CDE283001R1045	646055			0.290	3
3NO	400V	2.65	E203/45r	2CDE283001R0045	646062			0.290	3
4NO	400V	3.50	E204/45g	2CDE284001R1045	646239			0.390	2
4NO	400V	3.50	E204/45r	2CDE284001R0045	646246			0.390	2

Rated current = 63A

1NO	230V	1.65	E201/63g	2CDE281001R1063	645713			0.095	10
1NO	230V	1.65	E201/63r	2CDE281001R0063	645720			0.095	10
2NO	400 V	3.30	E202/63g	2CDE282001R1063	645898			0.190	5
2NO	400V	3.30	E202/63r	2CDE282001R0063	645904			0.190	5
3NO	400V	4.90	E203/63g	2CDE283001R1063	646079			0.290	3
3NO	400V	4.90	E203/63r	2CDE283001R0063	646086			0.290	3
4NO	400V	6.55	E204/63g	2CDE284001R1063	646253			0.390	2
4NO	400V	6.55	E204/63r	2CDE284001R0063	646260			0.390	2

No. of poles	rated voltage VAC	power loss W	order details type code	order code	bbn 4016779 EAN	price 1 piece	price group	w'ght 1 pc. kg	pack. unit pc.
--------------	-------------------	--------------	----------------------------	------------	-----------------------	------------------	----------------	----------------------	----------------------

Rated current = 80A

1NO	230V	2.60	E201/80g	2CDE281001R1080	645737			0.095	10
1NO	230V	2.60	E201/80r	2CDE281001R0080	645744			0.095	10
2NO	400V	5.15	E202/80g	2CDE282001R1080	645911			0.190	5
2NO	400V	5.15	E202/80r	2CDE282001R0080	645928			0.190	5
3NO	400V	7.75	E203/80g	2CDE283001R1080	646093			0.290	3
3NO	400V	7.75	E 203/80r	2CDE283001R0080	646109			0.290	3
4NO	400V	10.30	E204/80g	2CDE284001R1080	646277			0.390	2
4NO	400V	10.30	E204/80r	2CDE284001R0080	646284			0.390	2

Rated current = 100A

1NO	230V	3.95	E201/100g	2CDE281001R1100	645751			0.095	10
1NO	230 V	3.95	E201/100r	2CDE281001R0100	645738			0.095	10
2NO	400V	7.90	E202/100g	2CDE282001R1100	645935			0.190	5
2NO	400V	7.90	E202/100r	2CDE282001R0100	645942			0.190	5
3NO	400V	11.85	E203/100g	2CDE283001R1100	646116			0.290	3
3NO	400V	11.85	E203/100r	2CDE283001R0100	646123			0.290	3
4NO	400V	15.80	E204/100g	2CDE284001R1100	646291			0.390	2
4NO	400V	15.80	E204/100r	2CDE284001R0100	646307			0.390	2

Rated current = 125A

1NO	230V	6.10	E201/125g	2CDE281001R1125	645775			0.095	10
1NO	230V	6.10	E201/125r	2CDE281001R0125	645782			0.095	10
2NO	400 V	12.20	E202/125g	2CDE282001R1125	645959			0.190	5
2NO	400V	12.20	E202/125r	2CDE282001R0125	645966			0.190	5
3NO	400V	18.30	E203/125g	2CDE283001R1125	646130			0.33	3
3NO	400V	18.30	E203/125r	2CDE283001R0125	645147			0.33	3
4NO	400V	24.35	E204/125g	2CDE284001R1125	645314			0.44	2
4NO	400V	24.35	E204/125r	2CDE284001R0125	645321			0.44	2

MDRCs

MDRCs

Application: buildings, both residential and commercial

Description	order details		bbn	price	price	w'ght	pack.
	type code	order code	40 16779	1 piece	group	1 pc.	unit
Staircase lighting time delay switches	E232-230	2CDE 110 000 R0501	EAN 548243			kg 0.081	pc. 1

Description	order details		bbn	price	price	w'ght	pack.
	type code	order code	80 12542	1 piece	group	1 pc.	unit

Load shedding switch	LSS1/2	2CSM 112 500 R1311	EAN 274407			kg 0.400	pc. 1
----------------------	--------	--------------------	---------------	--	--	-------------	----------

Failsafe transformer 10-20-30VA rated power, 4-8-12V secondary rated voltage	TM30/12	2CSM 301 021 R0801	EAN 367505			kg 0.450	pc. 1
--	---------	--------------------	---------------	--	--	-------------	----------

Bell transformer input 230V, output 12V/1.33A	TS 16/12	2CSM 161 401 R0811	EAN 368908			kg 0.300	pc. 1
---	----------	--------------------	---------------	--	--	-------------	----------

Electro-mechanical modular bell 230VAC	SM1/230	2CSM 131 000 R0821	EAN 326304			kg 0.100	pc. 12
--	---------	--------------------	---------------	--	--	-------------	-----------

Modular buzzer 230VAC	RM1/230	2CSM 231 000 R0821	EAN 334507			kg 0.100	pc. 12
-----------------------	---------	--------------------	---------------	--	--	-------------	-----------

Modular electronic bell 12VAC+10 VA transformer (two-tones), 2 modules	TSM	2CSM 100 000 R0841	EAN 007005			kg 0.300	pc. 6
--	-----	--------------------	---------------	--	--	-------------	----------

Bell+buzzer+transformer, 2 modules, 24VAC	TSR	2CSM 100 000 R0831	EAN 369608			kg 0.300	pc. 1
---	-----	--------------------	---------------	--	--	-------------	----------

Daily program timer switch with standby battery (3 years), 1 channel	DTS 1/1	2CSM 111 000 R0601	EAN 506607			kg 0.150	pc. 1
--	---------	--------------------	---------------	--	--	-------------	----------

Digital time switches 2CO contact complement, 30 memory location	DTS 7/2	2CSM 122 000 R0601	EAN 506805			kg 0.150	pc. 1
--	---------	--------------------	---------------	--	--	-------------	----------

Twilight switches with sensor LS-1 with built-in weekly program timer switch	DTS7/2-TWS	2CSM 122 300 R1351	EAN 507307			kg 0,350	pc. 1
--	------------	--------------------	---------------	--	--	-------------	----------

Installation relays, Uc=230VAC or 115VDC, 1 NO	E 259 R10-230	2CSM111000R0401	EAN 532804			kg 0.100	pc. 10
--	---------------	-----------------	---------------	--	--	-------------	-----------

Installation relays, Uc=230VAC or 115VDC, 2 NO	E 259 R20-230	2CSM112000R0401	EAN 533603			kg 0.100	pc. 10
--	---------------	-----------------	---------------	--	--	-------------	-----------

Latching relays, Uc=230VAC or 115VDC, 1 NO	E 251-230	2CSM 111 000 R0201	EAN 530305			kg 0.114	pc. 12
--	-----------	--------------------	---------------	--	--	-------------	-----------

Latching relays, Uc=230VAC or 115VDC,2NO	E 252-230	2CSM 112 000 R0201	EAN 530800			kg 0.116	pc. 12
--	-----------	--------------------	---------------	--	--	-------------	-----------

Latching relays, Uc=230VAC or 115VDC, series	E 255-230	2CSM 119 000 R0201	EAN 531302			kg 0.121	pc. 12
--	-----------	--------------------	---------------	--	--	-------------	-----------

Latching relays, Uc=230VAC or 115VDC, 1 NO + 1NC	E 256-230	2CSM 114 000 R0201	EAN 531708			kg 0.116	pc. 12
--	-----------	--------------------	---------------	--	--	-------------	-----------

Description	order details		bbn	price	price	w'ght	pack.
	type code	order code	80 12542	1 piece	group	1 pc.	unit

Surge protection devices, class II, Imax=40kA, In=15kA, Up=1.2kV, Un=230V, Uc=275V	OVR 1N 40 275 P	2CTB 8139 52 R 11 00	EAN 506030			kg 0.220	pc. 1
--	-----------------	----------------------	---------------	--	--	-------------	----------

Surge protection devices, class II, Imax=40kA, In=15kA, Up=1.2kV, Un=230V, Uc=275V	OVR 3N 40 275 P	2CTB 8139 53 R 11 00	EAN 506283			kg 0.220	pc. 1
--	-----------------	----------------------	---------------	--	--	-------------	----------

N.B.: for more information about these products and to know the complete range, see the technical catalogue





In consideration of modifications to Standards and materials, the characteristics and overall dimensions indicated in this catalogue may be considered binding only following confirmation by ABB SACE

ABB SACE S.p.A.
ABB STOTZ-KONTAKT GmbH