

# Safety Technology for Factory Automation

Catalog SI 10 · 2011

















## Safety Integrated

Answers for industry.

**SIEMENS**

## Related catalogs

<p><b>SIMATIC</b> Products for Totally Integrated Automation and Micro Automation</p> <p>E86060-K4670-A101-B3-7600</p>	<p>ST 70</p> 	<p><b>Motion Control</b> SIMOTION, SINAMICS S120 and Motors for Production Machines</p> <p>E86060-K4921-A101-A2-7600</p>	<p>PM 21</p> 
<p><b>Industrial Controls</b> SIRIUS</p> <p>E86060-K1010-A101-A1-7600</p>	<p>IC 10</p> 	<p><b>SINAMICS S110</b> The Basic Positioning Drive</p> <p>E86060-K4922-A101-A1-7600</p>	<p>PM 22</p> 
<p><b>Industrial Communication</b> SIMATIC NET</p> <p>E86060-K6710-A101-B6-7600</p>	<p>IK PI</p> 	<p><b>SITRAIN</b> Training for Automation and Industrial Solutions</p> <p>Only available in German E86060-K6850-A101-C2</p>	<p>ITC</p> 
<p><b>Process Automation</b> Components for system integration</p> <p>(only PDF: E86060-K3511-A100-A8-7600)</p>	<p>PA 11</p> 	<p><b>Catalog CA 01</b> Products for Automation and Drives</p> <p>DVD: E86060-D4001-A510-C9-7600</p>	<p>CA 01</p> 
<p><b>Process Automation</b> Process Analytical Instruments</p> <p>E86060-K3501-A101-A6-7600</p>	<p>PA 01</p> 	<p><b>Industry Mall</b> Information and Ordering Platform in the Internet:</p> <p><a href="http://www.siemens.com/industrymall">www.siemens.com/industrymall</a></p>	
<p><b>Process Automation</b> Field Instruments for Process Automation</p> <p>E86060-K6201-A101-B3-7600</p>	<p>FI 01</p> 		
<p><b>SIMATIC HMI / PC-based Automation</b> Human Machine Interface Systems PC-based Automation</p> <p>E86060-K4680-A101-B7-7600</p>	<p>ST 80/ST PC</p> 		
<p><b>SINAMICS Drives</b> SINAMICS G130 Drive Converter Chassis Units SINAMICS G150 Drive Converter Cabinet Units</p> <p>E86060-K5511-A101-A5-7600</p>	<p>D 11</p> 		
<p><b>SINAMICS G110/SINAMICS G120</b> Standard Inverters <b>SINAMICS G120D</b> Distributed Inverters</p> <p>E86060-K5511-A111-A6-7600</p>	<p>D 11.1</p> 		

# Safety Integrated Safety Technology for Factory Automation

Catalog SI 10 · 2011



The products and systems described in this catalog are manufactured/distributed under application of a certified quality management system in accordance with DIN EN ISO 9001. The certificate is recognized by all IQNet countries.

Supersedes:  
Catalog SI 10 · 2009

Refer to the Industry Mall for current updates of this catalog:

[www.siemens.com/industrymall](http://www.siemens.com/industrymall)

The products contained in this catalog can also be found in the Interactive Catalog CA 01.

Order No.:  
E86060-D4001-A500-C9-7600

Please contact your local Siemens branch

© Siemens AG 2011

<p><b>Introduction</b> Totally Integrated Automation Totally Integrated Power Funktional safety of machines and plants Safety Integrated</p>	<p><b>1</b></p>
<p><b>Detecting</b> Detecting devices Commanding and signaling Human-machine interface systems Process analytical instruments</p>	<p><b>2</b></p>
<p><b>Evaluating / Communication</b> Communication over PROFIBUS / PROFINET Communication over AS-Interface Conventional design</p>	<p><b>3</b></p>
<p><b>Reacting</b> SIRIUS Industrial Controls ET 200S – Safety motor starters and frequency converter ET 200pro – Motor starters and frequency converters SINAMICS SINUMERIK</p>	<p><b>4</b></p>
<p><b>Appendix</b> B10 values Training Service &amp; Support Siemens Solution Partner Online services Conditions of sale and delivery Export regulations</p>	<p><b>5</b></p>

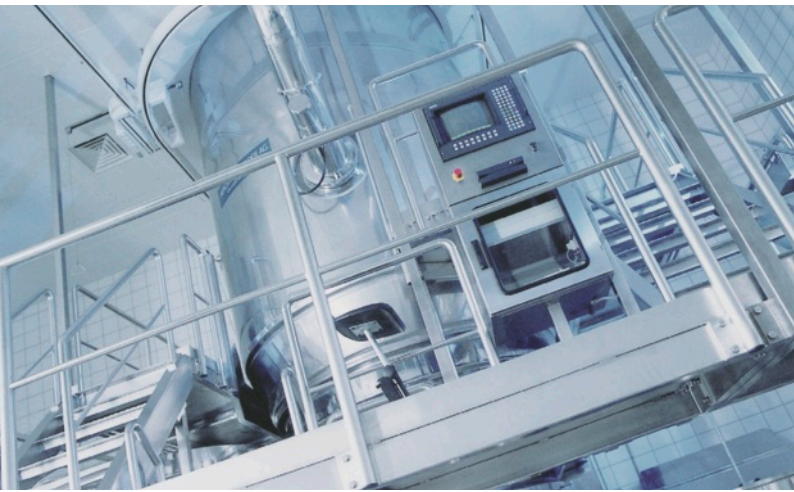

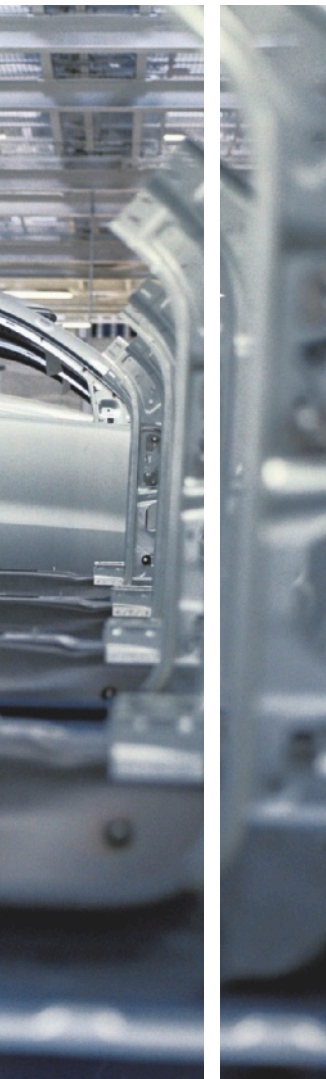

## Answers for industry.

Siemens Industry answers the challenges in the manufacturing and the process industry as well as in the building automation business. Our drive and automation solutions based on Totally Integrated Automation (TIA) and Totally Integrated Power (TIP) are employed in all kinds of industry. In the manufacturing and the process industry. In industrial as well as in functional buildings.

Siemens offers automation, drive, and low-voltage switching technology as well as industrial software from standard products up to entire industry solutions. The industry software enables our industry customers to optimize the entire value chain – from product design and development through manufacture and sales up to after-sales service. Our electrical and mechanical components offer integrated technologies for the entire drive train – from couplings to gear units, from motors to control and drive solutions for all engineering industries. Our technology platform TIP offers robust solutions for power distribution.

The high quality of our products sets industry-wide benchmarks. High environmental aims are part of our eco-management, and we implement these aims consistently. Right from product design, possible effects on the environment are examined. Hence many of our products and systems are RoHS compliant (Restriction of Hazardous Substances). As a matter of course, our production sites are certified according to DIN EN ISO 14001, but to us, environmental protection also means most efficient utilization of valuable resources. The best example are our energy-efficient drives with energy savings up to 60 %.

Check out the opportunities our automation and drive solutions provide. And discover how you can sustainably enhance your competitive edge with us.

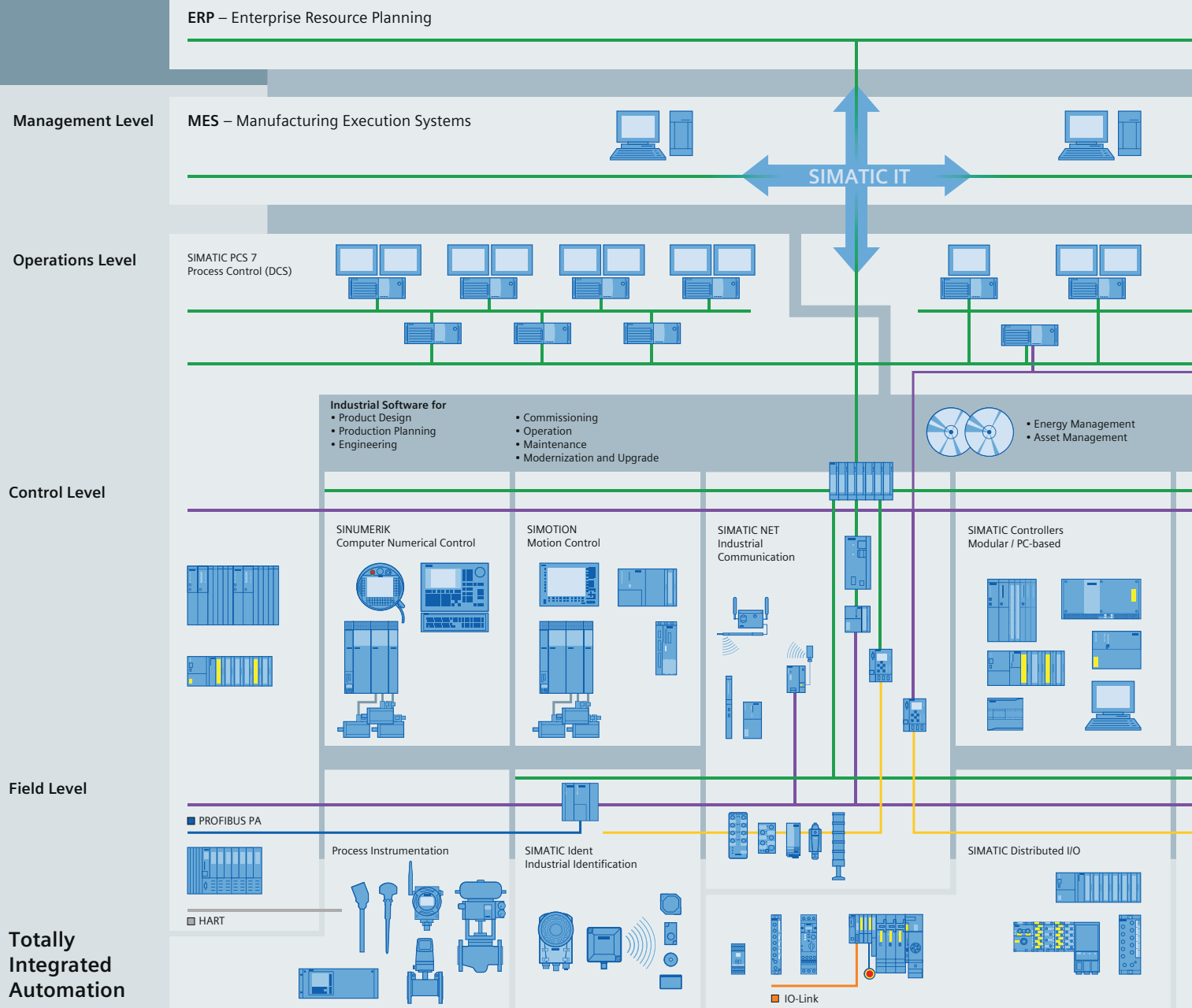

# Setting standards in productivity and competitiveness.

**Totally Integrated Automation.**

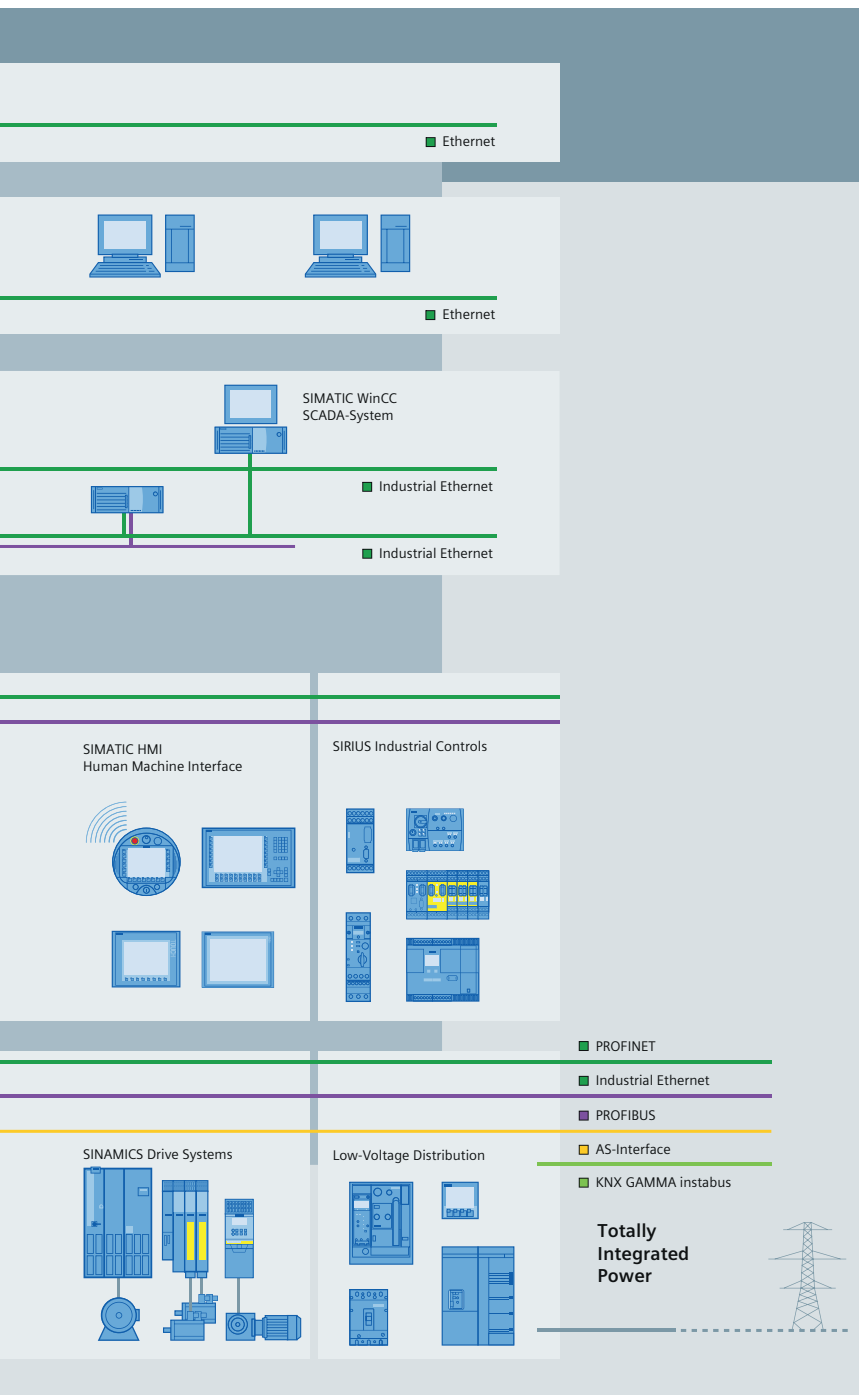

### TIA is characterized by its unique continuity.

It provides maximum transparency at all levels with reduced interfacing requirements – covering the field level, production control level, up to the corporate management level. With TIA you also profit throughout the complete life cycle of your plant – starting with the initial planning steps through operation up to modernization, where we offer a high measure of investment security resulting from continuity in the further development of our products and from reducing the number of interfaces to a minimum.

### The unique continuity is already a defined characteristic at the development stage of our products and systems.

The result: maximum interoperability – covering the controller, HMI, drives, up to the process control system. This reduces the complexity of the automation solution in your plant. You will experience this, for example, in the engineering phase of the automation solution in the form of reduced time requirements and cost, or during operation using the continuous diagnostics facilities of Totally Integrated Automation for increasing the availability of your plant.

Thanks to Totally Integrated Automation, Siemens provides an integrated basis for the implementation of customized automation solutions – in all industries from inbound to outbound.



## Integrated power distribution from one source.

**Totally Integrated Power.**



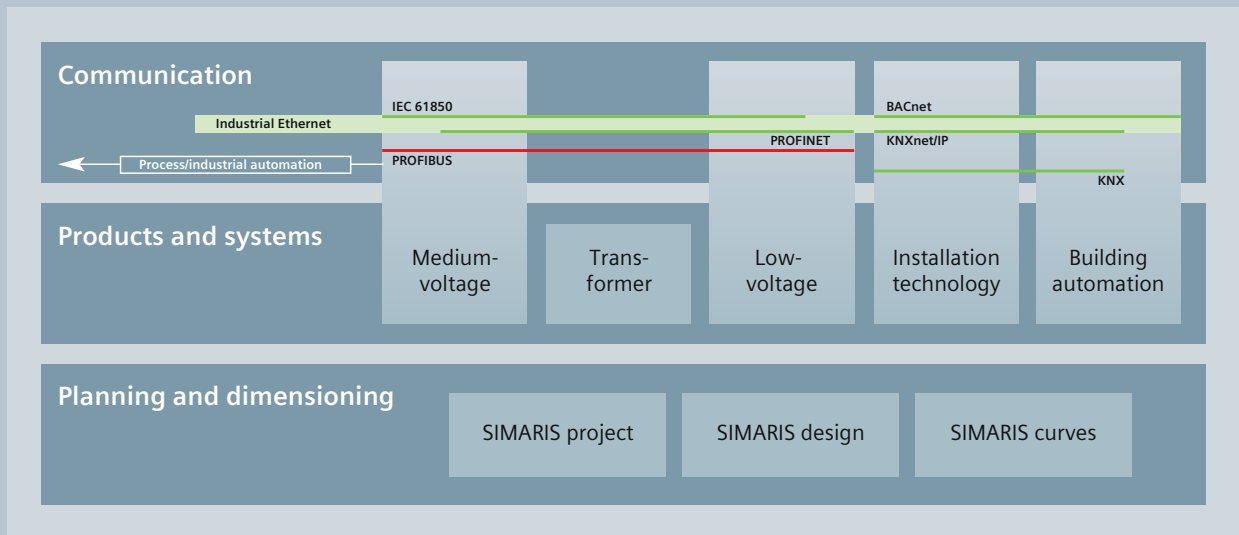

Electrical power distribution requires integrated solutions. Our answer: Totally Integrated Power (TIP). This includes tools and support for planning and configuration and a complete, optimally harmonized product and system portfolio for integrated power distribution from medium-voltage switchgear right to socket outlets.

The power distribution products and systems can be interfaced to building or industrial automation systems (as part of Total Building Solutions or Totally Integrated Automation) via communication capable circuit breakers and modules, allowing the full potential for optimization that an integrated solution offers to be exploited throughout the product cycle – from planning right through to installation and operation.

Thanks to a comprehensive energy management system, power flows can be made transparent and the energy consumption of individual loads can be calculated and allocated. Building operators can thus identify power-intensive loads and implement effective optimization measures. With its products and systems, Totally Integrated Power forms the basis for this functionality and guarantees greater cost-efficiency in industrial applications, infrastructure and buildings.

# Functional Safety of Machines and Systems

## Basic safety requirements in the production industry

### Functional safety

Automation systems and components are responsible for safety-related tasks in many different applications (machines and conveyor systems, process industry, building technology, etc.). This means that the health and safety of persons as well as protecting equipment and the environment depend on the correct functioning of the relevant systems and components. Today, the correct functioning of systems and components is handled under the term of "Functional Safety".

With the introduction of the uniform European Single Market, national standards and regulations affecting the technical realization of machines were consistently harmonized:

Definition of basic safety requirements, which address, on the one hand, machine manufacturers in terms of the free movement of goods (Article 95) and, on the other hand, machine operators in terms of industrial safety (Article 137).

The EU Directives:

- specify requirements for plants/systems and their operating companies to ensure the health and safety of personnel and the quality of the environment;
- include regulations regarding health and safety at the workplace (minimum-requirements);
- define product requirements (e.g. for machines) to ensure the health and safety of the user;
- differentiate requirements on the implementation of products to ensure the free exchange of goods and requirements on the use of products.

### Goals of the standard

It is the goal of safety technology to keep hazards for man and the environment as low as possible through technical equipment and devices. And at the same time, to not restrict industrial production more than is absolutely necessary.

### Conformity with the directives

To sell, market or operate products, these products must fulfill the basic safety requirements of the EU Directives.

To ensure compliance with a directive, it is recommended to apply the harmonized European standards, which then confers the so-called "presumption of conformity" and provides both manufacturers and operators with legal certainty concerning compliance with national regulations such as the EC directive.

With the CE marking, the manufacturer of a machine documents the compliance with all applicable directives and regulations in the free movement of goods. As the European directives are globally approved, the CE marking is also useful for exports to EEA countries.

The safety concept in the EC encompasses product requirements and social aspects

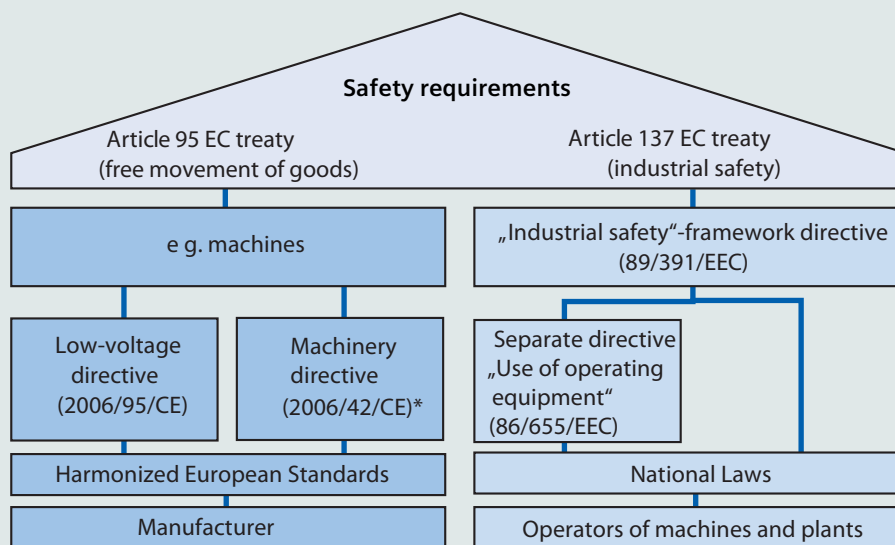

## The IEC 62061 standard

The IEC 62061 standard "safety of machines – functional safety of electrical, electronic and programmable controls of machines" defines comprehensive requirements. It includes recommendations for the development, integration and validation of safety-related electrical, electronic and programmable electronic control systems (SRECS) for machines. With the implementation of IEC 62061, for the first time, one standard covers the entire safety chain, from the sensor to the actuator. To attain a safety integrity level such as, for example, SIL 3, a certification of the individual components is no longer sufficient. Instead, the entire safety function must meet the defined requirements.

Requirements placed upon the capacity of non-electrical – e.g. hydraulic, pneumatic or electromechanical – safety-related control elements for machines are not specified by the standard.



## The ISO 13849-1 standard

The ISO 13849-1 standard "safety of machines – safety-related components of controls, part 1 general principles" is based on the known categories of EN 954-1, issue 1996. It covers the entire safety function with all devices involved.

ISO 13849-1 not only includes the quality approach of the EN 954-1, but also discusses safety functions in terms of quantity. Based on the categories, performance levels (PL) are used. The standard describes the determination of the PL for safety-related control components on the basis of designated architectures for the scheduled service life. In case of deviations, ISO 13849-1 refers to the IEC 61508. For the combination of several safety-related components into a total system, the standard contains information on the determination of the resulting PL.

The standard is applicable to safety-related control components (SRP/CS) and all types of machines, irrespective of the technology and energy used (electrical, hydraulic, pneumatic, mechanical, etc.).

## Our effort towards global harmonization of standards

To facilitate an even easier and faster realization of future machine concepts and to promote the free exchange of goods on global markets, we have consistently been working on the standardization of safety-related standards for many years. This commitment has contributed to the international acceptance of European directives and the harmonization of both international safety standards IEC 61508 and EN 954, which facilitate a more efficient realization of safety tasks by machine manufacturers and system operators.

## Our offer

As a partner for all safety-related concerns, we do not only support you by offering adequate safety-related products and systems. We also provide you with the most current know-how on international standards and regulations. We offer comprehensive training and services for machine manufacturers and system operators throughout the entire lifecycle of safety-related systems and machines.

- Consistent, certified product spectrum
- Courses on standards and regulations: [www.siemens.com/sitrain-safetyintegrated](http://www.siemens.com/sitrain-safetyintegrated) (Refer to the appendix for a summary of courses on Safety Integrated)
- Brochure „Functional Safety of Machines and Systems“ with step-by-step instructions, available under: [www.siemens.com/safety-infomaterial](http://www.siemens.com/safety-infomaterial)
- Consulting and support provided by Siemens contact partners for verification and validation
- Siemens Solution Partner for Safety Integrated
- World-wide service and support <http://support.automation.siemens.com>

For more information please visit [www.siemens.com/safety-integrated](http://www.siemens.com/safety-integrated)

## Safety Evaluation Tool

The Safety Evaluation Tool for the IEC 62061 and ISO 13849-1 standards takes you to your goal directly. This TÜV-tested online tool from the Safety Integrated program by Siemens supports the fast and reliable assessment of your machine's safety functions. As a result, you are provided with a standard-compliant report, which can be integrated in the documentation as proof of safety.

The Safety Evaluation Tool is available for free use: [www.siemens.com/safety-evaluation-tool](http://www.siemens.com/safety-evaluation-tool)

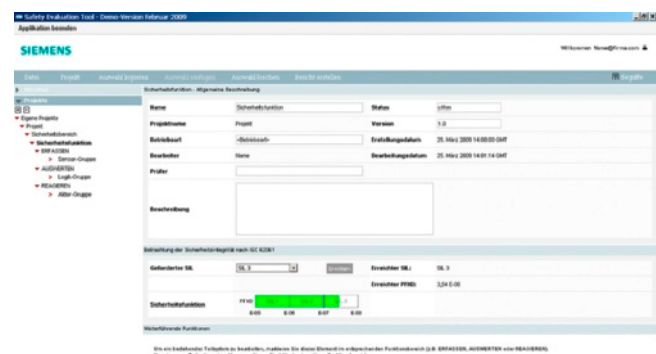

# Safety Integrated

## Integrated safety - increased productivity

Safety Integrated is the consistent implementation of safety technology in accordance with Totally Integrated Automation. On the one hand, this refers to the direct integration of safety-related functions in our standard products and, on the other hand, to the consistent and comfortable integration of safety concepts in the standard automation. This offers various advantages both for machine manufacturers and system operators, particularly in terms of efficiency.

Safety Integrated allows machine manufacturers to benefit from the decisive competitive advantage of eased engineering. This allows for a considerably faster realization of machines and systems and facilitates their easy adjustability to new requirements.

This concept also bears advantages for system operators as it does not only support the faster provision of safe machines and systems, but also enhances their productivity. Due to improved diagnostics, a harmonized overall system of safety technology and standard automation reduces downtimes and thus increases the system availability.

As opposed to conventional safety technology, Safety Integrated also facilitates conversion and modernization. On the basis of flexible and modularly expandable concepts, existing machines and systems can be upgraded to state-of-the-art technology. This advantage pays off throughout the entire lifecycle.

## Integrated safety from a single source

Safety Integrated is a unique, complete and consistent safety program. It covers all areas of safety technology, and includes detecting, evaluating, reacting, ranging from sensors and controls to drives.

Our products match the existing safety standards established in industry, including ISO, IEC, TÜV, NFPA, and UL. This catalog contains our comprehensive product range, helpful links to documentation and services associated with Safety.

The Internet provides up-to-date information on Safety Integrated:

[www.siemens.com/safety-integrated](http://www.siemens.com/safety-integrated)

## Safe Communication

For fail-safe communication, Safety Integrated uses both the tried-and-tested field bus systems AS-Interface and PROFIBUS as well as the innovative Industrial Ethernet standard PROFINET, which allows for new approaches to safe and efficient machines and systems – such as wireless fail-safe communication over IWLAN.

## Reduced expenditures and increased efficiency with Safety Integrated

The integration of safety technology into standard automation offers the following sustainable advantages:

### Increased efficiency

- A single system for standard and safety automation minimizes variety of types
- One bus and one engineering system for standard and safety technology reduce costs
- Software solutions allow for an eased reproduction of series machines

### Increased productivity

- Fast troubleshooting and extensive diagnostic functions reduce downtimes
- Fast restart after required system modifications
- Our additionally offered safe and fault-tolerant systems allow for production without downtimes

### Standardization

- Standard and safety technology come with a standardized interface
- Libraries improve re-usability
- Integration reduces the variety of control cabinets for machines
- Bus systems ease the installation technology in systems



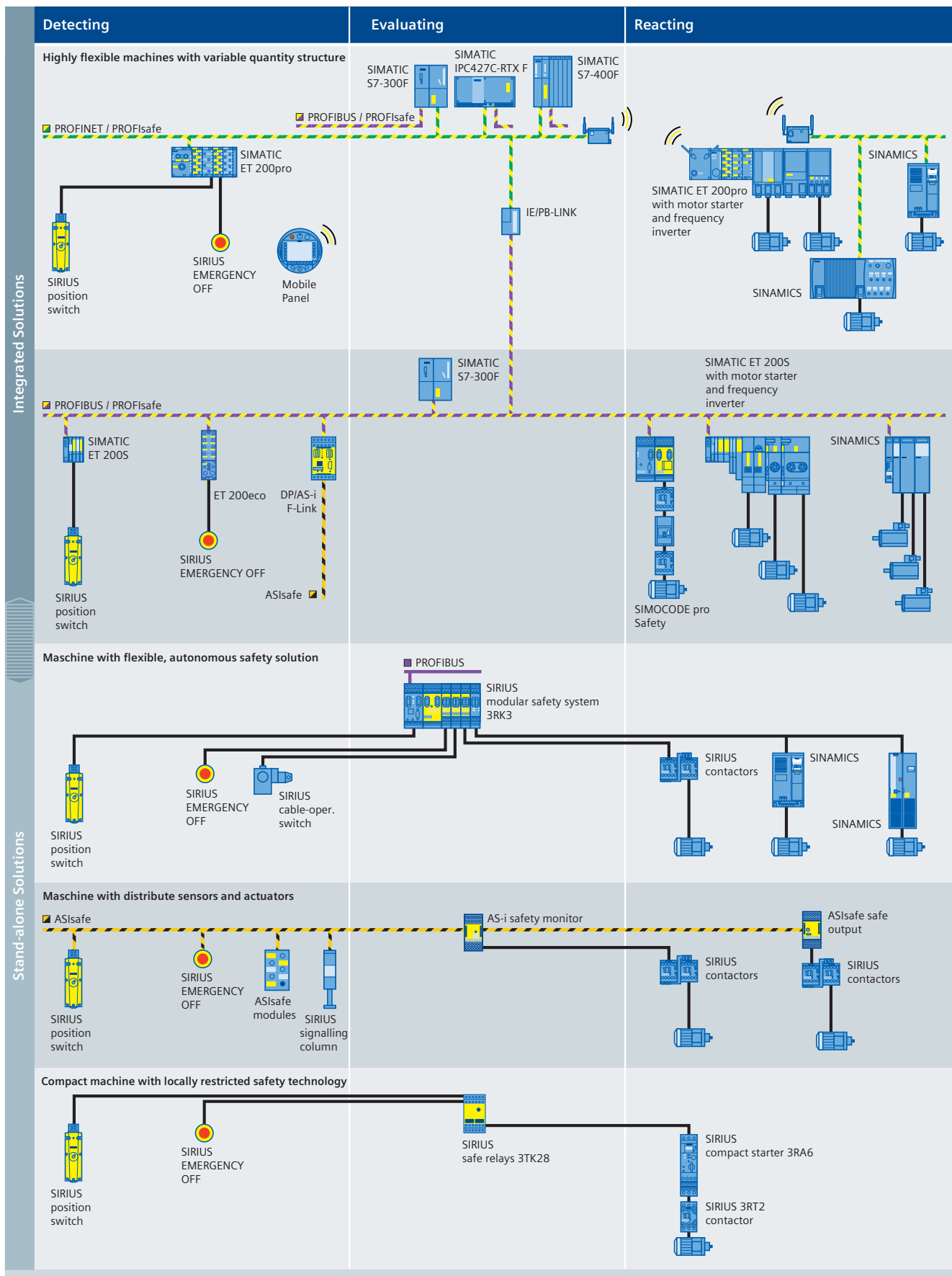



## Much more than a catalog. The Industry Mall.

You have a catalog in your hands that will serve you well for selecting and ordering your products. But have you heard of the electronic online catalog (the Industry Mall) and all its benefits? Take a look around it sometime:

[www.siemens.com/industrymall](http://www.siemens.com/industrymall)



### Selecting

Find your products in the structure tree, in the new "Bread-crum" navigation or with the integral search machine with expert functions. Electronic configurators are also integrated into the Mall. Enter the various characteristic values and the appropriate product will be displayed with the relevant order numbers. You can save configurations, load them and reset them to their initial status.

### Ordering

You can load the products that you have selected in this way into the shopping basket at a click of the mouse. You can create your own templates and you will be informed about the availability of the products in your shopping cart. You can load the completed parts lists directly into Excel or Word.

### Delivery status

When you have sent the order, you will receive a short e-mail confirmation which you can print out or save. With a click on "Carrier", you will be directly connected to the website of the carrier where you can easily track the delivery status.

### Added value due to additional information

So you have found your product and want more information about it? In just a few clicks of the mouse, you will arrive at the image data base, manuals and operating instructions. Create your own user documentation with My Documentation Manager. Also available are FAQs, software downloads, certificates and technical data sheets as well as our training programs. In the image database you will find, depending on the product, 2D/3D graphics, dimension drawings and exploded drawings, characteristic curves or circuit diagrams which you can download.

Convinced? We look forward to your visit!

# Detecting



2/2	<b>Detecting devices</b>	2/66	<b>... for explosion protection (ATEX)</b>	2/122	<b>3SE7 cable-operated switches</b>
2/4	<b>3SE5, 3SE2 position switches</b>	2/66	3SE5, metal enclosure, enclosure width 31 mm / 40 mm / 56 mm	2/122	3SF7 with metal enclosure
2/9	3SE5, molded-plastic enclosures, enclosure width 31 mm	2/74	<b>3SF1 position switches AS-Interface</b>	2/126	3SF2 for AS-Interface
2/13	Enclosure width 40 mm	2/76	Plastic enclosure, enclosure width 31 mm / 50 mm	2/127	<b>8WD4 signaling columns</b>
2/17	Enclosure width 50 mm	2/78	Metal enclosure, enclosure width 31 mm	2/134	<b>8WD5 integrated signal lamps</b>
2/20	Ambient temperatures up to -40 °C	2/80	Enclosure width 40 mm / 56 mm	2/135	<b>Human-machine interface systems</b>
2/22	3SE5, Metal enclosure, enclosure width 31 mm	2/82	<b>... with separate actuator</b>	2/135	<b>SIMATIC Mobile Panel 277(F) IWLAN</b>
2/26	Enclosure width 40 mm	2/83	Plastic enclosure, enclosure width 31 mm / 50 mm	2/140	<b>Process analytical instruments</b>
2/30	Enclosure width 56 mm	2/84	Metal enclosure, enclosure width 31 mm / 40 mm / 56 mm	2/140	<b>ULTRAMAT, OXYMAT, CALOMAT continuous gas analyzers</b>
2/34	Enclosure width 56 mm, XL	2/85	Accessories	2/141	<b>SITRANS P measuring instruments for pressure</b>
2/37	Ambient temperatures up to -40 °C	2/86	<b>... with interlocking</b>	2/142	<b>SITRANS T measuring instruments for temperature</b>
2/39	Compact design	2/87	Plastic enclosure with locking force >1200 N	2/143	<b>SITRANS F M flow meters</b>
2/41	3SE5, open-type design	2/88	Metal enclosure with locking force >2000 N	2/144	<b>SITRANS F C flow meters</b>
2/42	Accessories and spare parts for 3SE5, 3SE2	2/89	<b>... Hinge switches</b>	2/147	<b>SITRANS L fill level instruments</b>
2/45	<b>... with separate actuator</b>	2/89	Plastic enclosure, enclosure width 31 mm / 50 mm	2/147	Capacitive
2/47	3SE5, plastic enclosure, Enclosure width 31 mm / 50 mm	2/90	Metal enclosure, enclosure width 31 mm / 40 mm / 56 mm	2/150	Ultrasonic
2/48	Enclosure width 40 mm	2/91	<b>3SE6 magnetically operated switches</b>	2/151	Continuous
2/49	3SE5, metal enclosure, enclosure width 31 mm	2/94	<b>Commanding and signaling</b>	2/153	<b>Positioners SIPART PS2</b>
2/50	Enclosure width 40 mm / 56 mm	2/97	<b>3SB2 pushbuttons and Indicator lights, 16 mm</b>		
2/51	Accessories for above	2/101	<b>3SB3 pushbuttons and Indicator lights, 22 mm</b>		
2/52	3SE2, plastic enclosure, enclosure width 52 mm	2/110	F-Adapter AS-Interface		
2/53	<b>... with interlocking</b>	2/111	Accessories and spare parts for 3SB3		
2/57	3SE5, plastic enclosure, with locking force >1200 N	2/114	Enclosures		
2/58	3SE5, metal enclosure with locking force > 2000 N	2/118	Enclosures for AS-Interface		
2/59	Accessories for above	2/121	<b>3SB3 two-hand operation consoles</b>		
2/60	3SE2, metal enclosure with locking force <1800 N				
2/61	<b>... Hinge switches</b>				
2/62	3SE5, plastic enclosure, enclosure width 31 mm / 40 mm				
2/63	3SE5, metal enclosure, enclosure width 31 mm / 40 mm				
2/64	3SE2, plastic enclosure with integrated hinge				

### Delivery time classes (DT)

▶ Preferred type	Preferred types are available immediately from stock, i.e. are dispatched within 24 hours.
A 2 work days	
B 1 week	
C 3 weeks	In exceptional cases the actual delivery time may differ from that specified
D 6 weeks	The transport times depend on the destination and type of shipping. The standard transport time for Germany is 1 day.
X on request	The delivery times shown represent the state of 10/2010.

# Detecting devices

## Introduction

## Overview

2



**3SE5 23.,  
3SE5 21.  
3SF1 2.4**

**3SE5 24.,  
3SF1 244**

**3SE5 13.,  
3SE5 11.,  
3SF1 114**

**3SE5 12.,  
3SF1 124**

**3SE5 16.**

**3SE5 232,  
3SE5 212,  
3SF1 2.4**

**3SE5 132,  
3SE5 112,  
3SF1 1.4**

	Position switches, standard					Hinge switches	
<b>Enclosures</b>							
Plastic	✓	✓	✓	--	--	✓	✓
Metal	✓	--	✓	✓	✓	✓	✓
Dimensions (W x H x D) in mm	31 × 68 × 33	50 × 53 × 33	40 × 78 × 38	56 × 78 × 38	56 × 100 × 38	31 × 68 × 33	40 × 78 × 38
Degree of protection	IP65, IP66 / IP67	IP66 / IP67	IP66 / IP67	IP66 / IP67	IP66 / IP67	IP65, IP66 / IP67	IP66 / IP67
<b>Standards</b>							
IEC 60947-5-1	Mounting and operating points acc. to EN 50047	Operating points acc. to EN 50047	Mounting and operating points acc. to EN 50041	Operating points acc. to EN 50041	Operating points acc. to EN 50047	Mounting and operating points acc. to EN 50047	Mounting and operating points acc. to EN 50041
<b>Approvals</b>	CE, UL, CSA, CCC		CE, UL, CSA, CCC			CE, UL, CSA, CCC	
<b>Contact blocks</b>							
2 slow-action contacts	1 NO + 1 NC, 2 NC		1 NO + 1 NC, 2 NC		--	1 NO + 1 NC	
2 snap-action contacts	1 NO + 1 NC		1 NO + 1 NC		--	1 NO + 1 NC	
• Short stroke	1 NO + 1 NC		✓		--	✓	
• With 2 × 2 mm contact gap	1 NO + 1 NC		✓		--	✓	
3 slow-action contacts	1 NO + 2 NC, 2 NO + 1 NC		1 NO + 2 NC, 2 NO + 1 NC		--	1 NO + 2 NC	
• With make-before-break	1 NO + 2 NC		1 NO + 2 NC		--	1 NO + 2 NC	
3 snap-action contacts	1 NO + 2 NC		1 NO + 2 NC		--	1 NO + 2 NC	
2 × (2 or 3 contacts)	--		--		✓	--	
<b>Special features</b>							
LED status display	✓		✓		--	✓	
Increased corrosion protection	✓		✓		✓	✓	
<b>Explosion protection (ATEX)</b>	--		✓		✓	✓	
<b>ASIsafe integrated</b>	✓		✓		--	✓	
<b>Electrical specifications</b>							
Insulation voltage $U_i$	400 V		400 V		400 V		
Conventional thermal current $I_{the}$	6 A/10 A (3-/2-pole)		6 A/10 A (3-/2-pole)		6 A/10 A (3-/2-pole)		
<b>Connections</b>							
Cable entry	1 × M20 × 1.5	2 × M20 × 1.5	1 × M20 × 1.5	3 × M20 × 1.5	1 × M20 × 1.5	1 × M20 × 1.5	1 × M20 × 1.5
M12 connector socket, 4-, 5- or 8-pole	✓	✓	✓	✓	✓	✓	✓
Connector socket, 6-pole + PE	--	--	✓	✓	--	--	--
<b>Actuators</b>							
Rounded plungers and roller plungers	✓		✓		--		
Roller and angular roller levers	✓		✓		--		
Spring rods	✓		✓		--		
Twist levers and rod actuators	✓		✓		--		
Fork levers	--		✓		--		
Hinge switches	--		--		✓		
<b>Page</b>							
Complete units	2/9	2/17	2/26	2/30	2/34	2/62	2/63
Modular system	2/11	2/18	2/28	2/32	2/35	--	--
Ambient temperature -40 °C	2/20	2/20	2/37	2/37	--	--	--
ASIsafe	2/76	2/76	2/80	2/80	--	2/89	2/90
ATEX	2/67	--	2/70	2/70	2/71	2/69	2/73

✓ Available

-- Not available



3SE5 413,  
3SE5 423

3SE5 250

3SE5 232,  
3SE5 242,  
3SF1 2.43SE5 112,  
3SE5 122,  
3SF1 1.43SE5 322,  
3SE5 312,  
3SF1 3.4

3SE6

	Compact design	Open-type	Position switches with separate actuator		Position switches with interlocking	Magnetically operated switches
<b>Enclosures</b>						
Plastic	--	✓	✓	✓	✓	✓
Metal	✓	--	✓	✓	✓	--
Dimensions (W x H x D) in mm	30 x .. x .., 40 x .. x ..	30 x 48,5 x 20	31 x 68 x 33, 50 x 53 x 33	40 x 78 x 38, 56 x 78 x 38	54 x 185 x 44	M30 x 44, 19 x 33 x 13, 25 x 88 x 13
Degree of protection	IP66 / IP67	IP10 or IP20	IP65, IP66 / IP67	IP66 / IP67	IP66 / IP67	IP67
<b>Standards</b>	--	Mounting and operating points acc. to EN 50047	Mounting acc. to EN 50047	Mounting acc. to EN 50041	EN 1088	Category 3 or 4 acc. to ISO 13849-1 (EN 954-1)
IEC 60947-5-1	--					
<b>Approvals</b>	CE, UL, CSA	--	CE, TÜV, UL, CSA, CCC	CE, TÜV, UL, CSA, CCC	CE, TÜV, UL, CSA, CCC	CE, TÜV, UL, CSA
<b>Contact blocks</b>						
2 slow-action contacts	--	1 NO + 1 NC	1 NO + 1 NC	--	--	--
2 snap-action contacts	1 NO + 1 NC	1 NO + 1 NC	--	--	--	--
• Short stroke	--	✓	--	--	--	--
• With 2 x 2 mm contact gap	--	✓	--	--	--	--
3 slow-action contacts	--	1 NO + 2 NC	1 NO + 2 NC	--	--	--
• With make-before-break	--	1 NO + 2 NC	--	--	--	--
3 snap-action contacts	--	1 NO + 2 NC	--	--	--	--
6 slow-action contacts	--	--	--	--	2 x (1 NO + 2 NC)	--
Reed contacts	--	--	--	--	--	1 NO + 1 NC or 2 NC
<b>Special features</b>						
LED status display	--	--	✓	✓	✓	--
Increased corrosion protection	--	--	✓	✓	✓	--
<b>Explosion protection (ATEX)</b>	--	--	✓	--	--	--
<b>ASIsafe integrated</b>	--	--	✓	✓	✓	--
<b>Electrical specifications</b>						
Insulation voltage $U_i$	--	400 V	400 V	400 V	400 V	--
Conventional thermal current $I_{the}$	--	6 A	6 A	6 A	6 A	--
<b>Connections</b>						
Cable entry	--	--	1 x M20 x 1.5, 2 x M20 x 1.5	1 x M20 x 1.5, 3 x M20 x 1.5	3 x M20 x 1.5	--
M12 connector socket, 4- or 5-pole	✓	--	✓	✓	✓	✓
Molded cables	✓	--	--	--	--	✓
AS-Interface	--	--	✓	✓	✓	✓ (through I/O module)
<b>Actuators</b>						
Plungers, twist levers	✓	✓	--	--	--	--
Separate actuators	--	--	✓	✓	✓	--
<b>Page</b>						
Complete units	2/39	2/41	2/47	2/49	2/57, 2/58	--
Modular system	--	--	--	--	--	2/91
ASIsafe	--	--	2/83	2/84	2/87, 2/88	2/91
ATEX	--	--	2/69	2/73	--	--

✓ Available  
-- Not available

Note: For safety characteristics see Catalog IC 10, "Appendix" --> "Standards and approvals" --> "Overview"

# 3SE5, 3SE2 position switches

## General data

### Overview

The innovative SIRIUS 3SE5 position switches are modern in design, compact, modular and simple to connect. They save time and increase flexibility during installation of a whole range of switch variants. In principle it is possible to combine any enclosure with any operating mechanism, paying due consideration to the EN 50041 and EN 50047 standards where necessary.

#### Complete units

Popular versions of the position switches in standard enclosures are available as complete units.



3SE5 position switches with plastic and metal enclosures

#### Modular system

The 3SE5 series features a new modular system comprising different sizes of the basic switch and an actuator which must be ordered separately. Thanks to the modular design of the switch the user can select the right solution for his application from numerous versions and install it himself in a very short time.

An easy plug-in method enables fast replacement of the actuator heads.



Examples of selection options in the modular system

#### Design

All enclosure variants have an integrated chlorinated rubber diaphragm (high functional safety in cold and aggressive environments).

#### Enclosure sizes

The 3SE5 switches are available in five different enclosure sizes with 2 or 3 contacts and with the XL enclosure:

- Open-type position switch IP20 or IP10
- Molded-plastic enclosures according to EN 50047, 31 mm wide, IP65, 1 cable entry
- Metal enclosures according to EN 50047, 31 mm wide, IP66 / IP67, 1 cable entry
- Plastic and metal enclosures according to EN 50041, 40 mm wide, IP66 / IP67, 1 cable entry
- Molded-plastic enclosures, 50 mm wide, IP66 / IP67, 2 cable entries
- Metal enclosures, 56 mm wide, IP66 / IP67, 3 cable entries
- XL metal enclosures with 4 to 6 contacts, 56 mm wide, IP66 / IP67, 3 cable entries

#### Enclosure versions

Various basic switches can be selected for the 3SE5 series:

- With contact blocks with two or three contacts (screw terminals) designed as slow-action or snap-action contacts; the slow-action contacts also with make-before-break
- Optional LED status display
- With mounted four- or five-pole M12 connector socket (available for the wide enclosures as an accessory for self-assembly)
- With 6-pole connector socket + PE on the metal enclosures
- Versions with increased corrosion protection
- Versions for operating temperature up to  $-40\text{ °C}$
- Metal enclosures for explosion protection (ATEX) (see page 2/66)
- AS-Interface version with integrated ASIsafe electronics for all enclosure designs (see page 2/74)

#### Actuator variants

All operating mechanisms can be rotated around the axis in increments of  $22.5^\circ$ . The following actuator variants are available:

- Standard, rounded and roller plungers
- Roller and angular roller levers
- Spring rod
- Twist levers and rod actuators with twist actuator
- Fork levers with twist actuator

The actuator rollers are available with various materials and diameters.

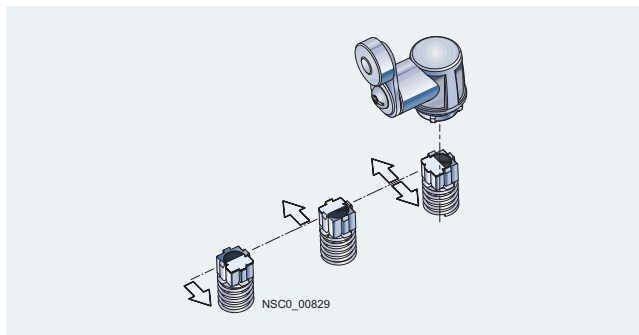

Twist actuators for twist levers and rod actuators, with setting of switching to right, left or right/left (standard for all twist actuators except fork levers)

**Optional LED indicators**

LED indicators  
available for all enclosure sizes



The enclosure versions can be supplied with an LED signaling indicator (1 × green + 1 × yellow). This is the first time that optical signaling equipment is also available for small standard enclosures according to EN 50047. The LED signaling indicators are available in all common voltages (24 V DC and 230 V AC).

**Additional contacts**

Exchangeable two and three-pole contact blocks  
for all enclosure sizes



The three-pole contact block with snap-action or slow-action contacts is regularly available for all enclosure forms. The same installation space is required as for a two-pole block. The version with 1 NO + 2 NC offers for example more safety through redundant shutdowns (2 NC contacts) with simultaneous signaling (1 NO contact). The three-pole blocks are also available with make-before-break and with 2 NO + 1 NC.

**Contact reliability**

The new switching blocks ensure an extremely high contact stability. This applies even when the devices are switching low voltages and currents, e.g. 1 mA at 5 V DC.

**Positive opening** ☞

The NC contacts of the switch are forced open mechanically, positively-driven and reliably by the plunger. This is referred to as "positive opening".

**Mounting**

Easy plug-in method  
for fast replacement of the actuator heads



Open the cover (1)  
Actuate the locking lever (2)  
Replace the head (turnable by 16 × 22.5°) (3)  
Lock and close the cover

**Quick-connect technology**

For molded-plastic enclosure with a width of 31 mm

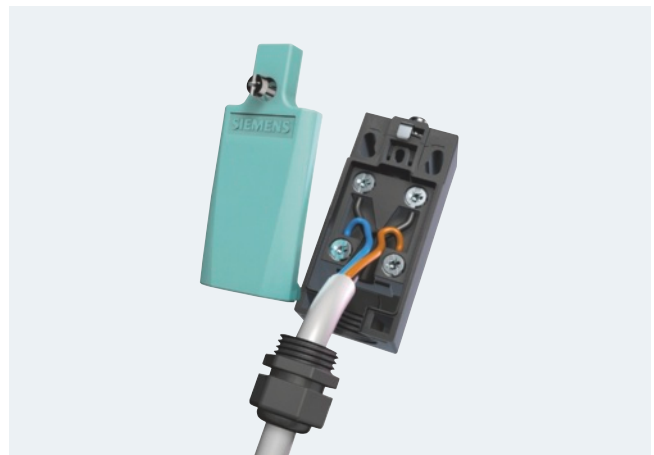

These position switches can be wired quickly and easily as an added customer benefit. The connecting cable is first connected to the terminals of the contact block and then guided through a slit into the cable gland opening. The time saved through this new connection method is approx. 20 to 25 %.

A cable gland with seal must be used with the quick-connect method.

# 3SE5, 3SE2 position switches

## General data

### Benefits

The 3SE5 position switches differ from the previous series through the following new characteristics:

- The modular structure of the product range allows a number of versions with a smaller number of bearing types for enclosures and operating mechanisms.
- All actuators can be turned around the axis in increments of 22.5° (see picture on page 2/5).
- Rounded and roller plungers according to EN 50041 with 3 mm overtravel (total travel 9 mm) for greater tolerance when switching.
- All enclosure sizes – now also including the small enclosure 31 mm wide – are optionally available with an LED signaling indicator (see picture on page 2/5).
- All enclosure variants have an integrated chlorinated rubber diaphragm (high functional safety in cold and aggressive environments).
- All contact blocks are replaceable (see page 2/43).
- The three-pole contact blocks are available for all enclosure sizes (see picture on page 2/5).
- Elements with 1 NO + 2 NC slow-action contacts with make-before-break and 2 NO + 1 NC
- The short-stroke contact block 1 NO + 1 NC improves the precision of the switching operation through a reduced actuation path.
- The switching element with 1 NO + 1 NC snap-action contacts with 2 x 2 mm contact opening is suitable for simultaneous disconnection and signaling, particularly in the elevator industry
- **NEW:** XL enclosures for accommodating two 2- or 3-pole contact blocks
- The molded-plastic enclosure with a width of 31 mm has simple and fast wiring equipment which makes it possible to save from approx. 20 to 25 % of the time when connecting (see picture on page 2/5).
- The ASIsafe electric component is integrated for the versions with the AS-Interface connection (see page 2/74); an additional adapter is not required.

### Application

With the standard position switches, mechanical positions of moved machine parts are converted into electrical signals. Through their modular and uniform design and large number of variants, the devices can meet practically all requirements in industry.

Devices are available with enclosure versions to suit the particular ambient conditions. Different control tasks can be performed with the best contact blocks suited for the particular purpose. And many different actuator variants are available to match the mechanical configuration of the moved machined parts. Dimensions, fixing points and characteristics are largely in accordance with the EN 50041 or EN 50047 standards.

The devices are suitable for use in any climate.

#### Standards

IEC 60947-5-1 or EN 60947-5-1.



The protective measure of "total insulation" by the molded-plastic enclosure is guaranteed by the use of molded-plastic screw-glands.

### Safety position switches

For controls according to IEC 60204-1 or EN 60204-1 the devices can be used as a safety position switch. To secure position switches against changes in their position, keyed techniques must be employed on installation.

### Safety circuits

IEC 60947-5-1 and EN 60947-5-1 require positive opening of the NC contacts, i.e. for the purposes of personal safety, the assured opening of NC contacts is expressly stipulated for the electrical equipment of machines in all safety circuits and marked according to the IEC standard 60947-5-1 with the symbol .

Category 2 according to ISO 13849-1 (EN 954-1) can be attained with 3SE5 position switches with , and category 3 or 4 when using an additional position switch, if the corresponding failsafe evaluation units are selected and correctly installed, e.g. the 3TK28 safety relays or matching devices from the ASIsafe, SIMATIC or SINUMERIK product ranges. The operating mechanisms (actuators) must also be connected to the enclosure by keyed techniques. The corresponding operating mechanisms are marked in the catalog with .

### Contacts for each application

- **Snap-action contacts:** NC and NO contacts switch simultaneously – regardless of the actuating speed ( $v_{\min} = 0.01$  m/s) and contact erosion.
- **Slow-action contacts:** Difference in travel between "NC contact opens" and "NO contact closes"; the switching speed is the same as or proportional to the actuating speed ( $v_{\min} = 0.4$  m/s).
- **Slow-action contacts with make-before-break:** e.g. suitable for adding a second function to a sequence control.

### Operating mechanisms for each application

#### Standard, rounded and roller plungers

- Operation in direction of the plunger axis or in case of roller plunger with bar at right angles to the plunger axis
- The roller plunger is recommended for lateral actuation and relatively long overtravel.

#### Roller and angular roller levers

- For actuators made of finely ground steel in the form of cams, straight-edges (approach angle 30°) or cam disks

#### Twist levers

- For a high starting speed ( $v = 1.5$  m/s)
- Variety of starting options
- Insensitive to oil, grinding dust and coarse-grained material
- Adjustment of the lever in increments of 10°.
- Can be adjusted with left or right switching

## Technical specifications

Type		3SE5 1..., 3SE5 2..	3SE5 41.	3SE5 42.
<b>General data</b>				
<b>Standards</b>		IEC 60947-5-1, EN 60947-5-1		
<b>Rated insulation voltage <math>U_i</math></b>	V	400	400	400
<b>Pollution degree</b> acc. to EN 60664-1		Class 3	Class 3	Class 3
<b>Rated impulse withstand voltage <math>U_{imp}</math></b>	kV	6	4	4
<b>Rated operational voltage <math>U_e</math></b>	V	400 V AC, over 300 V AC only for equal potential <sup>1)</sup>	300 AC	300 AC
<b>Conventional thermal current <math>I_{th}</math></b>	A	10	6	10
<b>Rated operational current <math>I_e</math></b>		2-pole	3-pole	2-pole
• With alternating current 50/60 Hz		$I_e/AC-15$	$I_e/AC-15$	$I_e/AC-15$
- At 24 V	A	6	6	6
- At 120 V	A	6	3	6
- At 240 V	A	3	1.5	3
• For direct current		$I_e/DC-13$	$I_e/DC-13$	$I_e/DC-13$
- At 24 V	A	3	3	3
- At 125 V	A	0.55	0.55	0.55
- At 250 V	A	0.27	0.27	0.27
<b>Short-circuit protection<sup>2)</sup></b>				
• With DIAZED fuse links, operational class gG	A	6		
• With miniature circuit breaker, Char. C	A	1	2	1
<b>Mechanical endurance</b>				
• Basic switches		15 × 10 <sup>6</sup> operating cycles	30 × 10 <sup>6</sup> operating cycles	30 × 10 <sup>6</sup> operating cycles
• With spring rod, 3SE5 ...-R..		10 × 10 <sup>6</sup> operating cycles	--	--
• With fork lever, 3SE5 1...-T..		1 × 10 <sup>6</sup> operating cycles	--	--
<b>Electrical endurance</b>				
• With 3RH.1, 3RT contactors in size S00, S0		10 × 10 <sup>6</sup> operating cycles	10 × 10 <sup>6</sup> operating cycles	5 × 10 <sup>6</sup> operating cycles
• For utilization category AC-15 when switching off $I_e/AC-15$ at 240 V		0.1 × 10 <sup>6</sup> operating cycles	--	--
• With utilization category DC-12/DC-13		For direct current depending on the loading of the switch		
<b>Switching frequency</b> With 3RH.1, 3RT contactors in size S00, S0		6000 operating cycles/h	1800 operating cycles/h	
<b>Switching accuracy</b> For repeated switching, measured at the plunger of the contact block	mm	0.05		
• With twist actuators		1°		
<b>Rated data according to <math>\mathcal{E}</math>, <math>\mathcal{R}</math> and <math>\mathcal{A}</math>.</b>				
• Rated voltage	V	300		
• Uninterrupted current	A	6		
• Switching capacity		Heavy duty, A 300/ B 300 /Q 300	A 300 / Q 300	

<sup>1)</sup> For slow-action contacts 1 NO + 2 NC with make-before-break and  
2 NO + 1 NC the following applies: over 250 V AC only equal potential.

<sup>2)</sup> Without any welds according to EN 60947-5-1.

Type		3SE5 23.	3SE5 13	3SE5 24.	3SE5 21.	3SE5 11.	3SE5 12., 3SE5 16.	3SE5 4..	3SE5 25.	
<b>Enclosures</b>										
<b>Enclosures</b>		Ultramid A3X2G7			Zinc diecasting GD Zn Al4 Cu1				--	
• Material										
• Width	mm	31	40	50	31	40	56	30 / 40	30	
<b>Degree of protection</b> acc. to EN 60529		IP65	IP66 / IP67 <sup>1)</sup>					IP67	IP20, IP10	
<b>Ambient temperature</b>										
• During operation	°C	-25 ... +85							-25 ... +85	-25 ... +85
• In operation, switch with LEDs	°C	-25 ... +70							--	--
• Storage, transport	°C	-40 ... +90							-40 ... +90	-40 ... +90
<b>Mounting position</b>		Any								
<b>Connection</b>										
<b>Cable entry</b>		1 × (M20 × 1.5)	2 × (M20 × 1.5)		1 × (M20 × 1.5)	3 × (M20 × 1.5)	--	--	--	
<b>Conductor cross-sections<sup>2)</sup></b>										
• Solid	mm <sup>2</sup>	2 × (0.5 ... 0.75), 1 × (0.5 ... 1.5)								
• Finely stranded with end sleeve	mm <sup>2</sup>	2 × (0.5 ... 1.5)								
<b>Tightening torque</b> , contact block	Nm	0.8 ... 1.0								
<b>Protective conductor connection</b> inside enclosure		--			M3.5			--	--	

<sup>1)</sup> For twist actuators with spring rod and rod actuators: IP65/IP67.

<sup>2)</sup> For the maximum number of connectable conductors for the respective contact block see operating instructions.

# 3SE5, 3SE2 position switches

## General data

### Options

On the following pages you will find selection tables for complete units as well as components of the modular system.

Complete units

Modular system

The differences between the units are indicated in the selection and ordering data by the symbols shown on orange backgrounds.

Using the modular system you can assemble switch variants which are not available as complete units. Each complete unit can also be supplied as a module.

A basic switch for the modular system comprises an enclosure with a contact block and a cover. Among the basic switches the following versions, for example, can be selected:

- Basic enclosure with teflon plunger
- Version with increased corrosion protection

- Version with 2 LEDs
- Version with M12 connector socket or 6-pole + PE
- Version with M12 connector socket and with 2 LEDs

For the molded-plastic enclosures with a width of 31 and 50 mm the basic switches are designed as complete units with rounded plunger (according to standard).

### Online configurator

The online configurator helps you not only to select and order the right switch but also to create complete product documentation.

- Product data sheets
- Dimensional drawings
- Operating travel diagrams
- CAD data in 2D and 3D model images
- Ordering data
- Product photos

[www.siemens.com/industrial-controls/configurators](http://www.siemens.com/industrial-controls/configurators)

### Complete units

#### Ordering example

Required:

- Position switch according to EN 50047 in a molded-plastic enclosure
- Contact block with slow-action contacts 1 NO + 1 NC
- Angular roller lever, metal lever and plastic roller

To be ordered:

Version	Complete units
	<input type="checkbox"/>
Order No.	

Complete units • Enclosure width 31 mm	
 <p><b>Angular roller levers</b> With metal lever and plastic roller 13 mm Slow-action contacts 1 NO + 1 NC</p>	<b>3SE5 232-0BF10</b>

### Modular system

#### Ordering example 1

Required:



- Position switch according to EN 50047 in a molded-plastic enclosure
- Contact block with slow-action contacts 1 NO + 1 NC
- Angular roller lever, metal lever and plastic roller

#### Ordering example 2



Required:

- Position switch according to EN 50047 in a molded-plastic enclosure
- Contact block with slow-action contacts 1 NO + 1 NC
- Twist lever, high-grade steel lever and plastic roller

To be ordered separately:

Version	Modular system
	<input checked="" type="checkbox"/>
Order No.	
Basic switches • Enclosure width 31 mm	
 <p><b>With teflon plunger</b> Slow-action contacts 1 NO + 1 NC</p>	<b>3SE5 232-0BC05</b>
+	
Operating mechanisms	
 <p><b>Angular roller levers</b> Metal lever, plastic roller</p>	<b>3SE5 000-0AF10</b>









To be ordered separately:

Version	Modular system
	<input checked="" type="checkbox"/>
Order No.	
Basic switches • Enclosure width 31 mm	
 <p><b>With teflon plunger</b> Slow-action contacts 1 NO + 1 NC</p>	<b>3SE5 232-0BC05</b>
+	
Twist actuators	
 <p><b>Twist actuators</b></p>	<b>3SE5 000-0AK00</b>
 <p><b>Twist levers</b> High-grade steel lever, plastic roller</p>	<b>3SE5 000-0AA31</b>

## Selection and ordering data

## Complete units

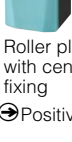
2 or 3 contacts · Degree of protection IP65 · Cable entry M20 × 1.5<sup>1)</sup>

Version	Contacts	LEDs	DT	Complete units
				Order No. <input type="checkbox"/>
<b>Complete units<sup>2)</sup> • Enclosure width 31 mm</b>				
<b>Rounded plungers, type B, acc. to EN 50047</b>				
 Rounded plunger	<b>With teflon plunger</b>			
	Slow-action contacts	1 NO + 1 NC --	⊕ ▶	<b>3SE5 232-0BC05</b>
	Snap-action contacts	1 NO + 1 NC --	⊕ B	<b>3SE5 232-0CC05</b>
	Snap-action contacts, integrated <sup>3)</sup>	1 NO + 1 NC --	⊕ ▶	<b>3SE5 232-0HC05</b>
	Snap-action contacts • Short-stroke, integrated <sup>3)</sup>	1 NO + 1 NC --	⊕ B	<b>3SE5 232-0FC05</b>
	Snap-action contacts • 2 × 2 mm contact gap	1 NO + 1 NC --	⊕ B	<b>3SE5 232-0GC05</b>
	Slow-action contacts	1 NO + 2 NC --	⊕ A	<b>3SE5 232-0KC05</b>
	Snap-action contacts	1 NO + 2 NC --	⊕ A	<b>3SE5 232-0LC05</b>
	Slow-action contacts with make-before-break	1 NO + 2 NC --	⊕ A	<b>3SE5 232-0MC05</b>
	Slow-action contacts	2 NO + 1 NC --	⊕ A	<b>3SE5 232-0PC05</b>
 With increased corrosion protection	<b>With increased corrosion protection</b>			
	Slow-action contacts	1 NO + 1 NC --	⊕ B	<b>3SE5 232-0BC05-1CA0</b>
	Snap-action contacts	1 NO + 1 NC --	⊕ B	<b>3SE5 232-0CC05-1CA0</b>
	Slow-action contacts	1 NO + 2 NC --	⊕ B	<b>3SE5 232-0KC05-1CA0</b>
	Snap-action contacts	1 NO + 2 NC --	⊕ B	<b>3SE5 232-0LC05-1CA0</b>
	Slow-action contacts with make-before-break	1 NO + 2 NC --	⊕ B	<b>3SE5 232-0MC05-1CA0</b>
	Slow-action contacts	2 NO + 1 NC --	⊕ B	<b>3SE5 232-0PC05-1CA0</b>
 With 2 LEDs	<b>With M12 connector socket, 4-pole (250 V, 4 A)</b>			
	Slow-action contacts	1 NO + 1 NC --	⊕ B	<b>3SE5 234-0BC05-1AC4</b>
	Snap-action contacts, integrated <sup>3)</sup>	1 NO + 1 NC --	⊕ A	<b>3SE5 234-0HC05-1AC4</b>
	Slow-action contacts	2 NC --	⊕ B	<b>3SE5 234-0KC05-1AE0</b>
	Snap-action contacts	2 NC --	⊕ A	<b>3SE5 234-0LC05-1AE0</b>
 With 2 LEDs	<b>With 2 LEDs, yellow/green</b>			
	Slow-action contacts	1 NO + 2 NC 24 V DC	⊕ B	<b>3SE5 232-1KC05</b>
	Snap-action contacts	1 NO + 2 NC 24 V DC	⊕ B	<b>3SE5 232-1LC05</b>
	Slow-action contacts	1 NO + 2 NC 230 V AC	⊕ B	<b>3SE5 232-3KC05</b>
	Snap-action contacts	1 NO + 2 NC 230 V AC	⊕ B	<b>3SE5 232-3LC05</b>
 With 2 LEDs	<b>With M12 connector socket, 5-pole (125 V, 4 A) and 2 LEDs</b>			
	Slow-action contacts	1 NO + 1 NC 24 V DC	⊕ B	<b>3SE5 234-1BC05-1AF3</b>
	Snap-action contacts	1 NO + 1 NC 24 V DC	⊕ B	<b>3SE5 234-1CC05-1AF3</b>
<b>Roller plungers, type C acc. to EN 50047</b>				
 Roller plunger	<b>With plastic roller 10 mm</b>			
	Slow-action contacts	1 NO + 1 NC --	⊕ B	<b>3SE5 232-0BD03</b>
	Snap-action contacts • Integrated <sup>3)</sup>	1 NO + 1 NC --	⊕ ▶	<b>3SE5 232-0HD03</b>
	Snap-action contacts • Short-stroke, integrated <sup>3)</sup>	1 NO + 1 NC --	⊕ B	<b>3SE5 232-0FD03</b>
	Slow-action contacts	1 NO + 2 NC --	⊕ B	<b>3SE5 232-0KD03</b>
	Snap-action contacts	1 NO + 2 NC --	⊕ B	<b>3SE5 232-0LD03</b>
 Actuator head rotated by 90°	<b>Actuator head rotated by 90°</b>			
	Snap-action contacts	1 NO + 2 NC --	⊕ B	<b>3SE5 232-0LD03-1AH0</b>
 Roller plunger with central fixing	<b>With M12 connector socket, 4-pole (250 V, 4 A)</b>			
	Snap-action contacts, integrated <sup>3)</sup>	1 NO + 1 NC --	⊕ B	<b>3SE5 234-0HD03-1AC4</b>
 Roller plunger with central fixing	<b>Roller plungers with central fixing</b>			
	Snap-action contacts, integrated <sup>3)</sup>	1 NO + 1 NC --	⊕ B	<b>3SE5 232-0HD10</b>
	Slow-action contacts	1 NO + 2 NC --	⊕ B	<b>3SE5 232-0KD10</b>

⊕ Positive opening according to IEC 60947-5-1, Appendix K.

<sup>1)</sup> A cable gland with seal must be used with the quick-connect method.<sup>2)</sup> Popular versions.<sup>3)</sup> Subsequent replacement of contact blocks is not possible.

# 3SE5, 3SE2 position switches

## 3SE5, molded-plastic enclosures Enclosure width 31 mm according to EN 50047

2 or 3 contacts · Degree of protection IP65 · Cable entry M20 × 1.5<sup>1)</sup>

Version	Contacts	LEDs	DT	Complete units
				<input type="checkbox"/>
				Order No.

### Complete units<sup>2)</sup> · Enclosure width 31 mm



Roller lever

#### Roller levers, type E acc. to EN 50047

##### With metal lever and plastic roller 13 mm

Slow-action contacts	1 NO + 1 NC --	⊕ A	<b>3SE5 232-0BE10</b>
Snap-action contacts, integrated <sup>3)</sup>	1 NO + 1 NC --	⊕ ▶	<b>3SE5 232-0HE10</b>
Slow-action contacts	1 NO + 2 NC --	⊕ B	<b>3SE5 232-0KE10</b>
Snap-action contacts	1 NO + 2 NC --	⊕ B	<b>3SE5 232-0LE10</b>

##### With M12 connector socket, 4-pole (250 V, 4 A)

Snap-action contacts, integrated <sup>3)</sup>	1 NO + 1 NC --	⊕ B	<b>3SE5 234-0HE10-1AC4</b>
--	----------------	-----	----------------------------

#### Angular roller levers

##### With metal lever and plastic roller 13 mm

Slow-action contacts	1 NO + 1 NC --	⊕ B	<b>3SE5 232-0BF10</b>
Snap-action contacts, integrated <sup>3)</sup>	1 NO + 1 NC --	⊕ A	<b>3SE5 232-0HF10</b>
Slow-action contacts	1 NO + 2 NC --	⊕ B	<b>3SE5 232-0KF10</b>
Snap-action contacts	1 NO + 2 NC --	⊕ B	<b>3SE5 232-0LF10</b>



Angular roller lever

#### Twist levers, type A acc. to EN 50047

##### With metal lever 21 mm and plastic roller 19 mm

Slow-action contacts	1 NO + 1 NC --	⊕ A	<b>3SE5 232-0BK21</b>
Snap-action contacts, integrated <sup>3)</sup>	1 NO + 1 NC --	⊕ B	<b>3SE5 232-0HK21</b>
Slow-action contacts	1 NO + 2 NC --	⊕ B	<b>3SE5 232-0KK21</b>
Snap-action contacts	1 NO + 2 NC --	⊕ B	<b>3SE5 232-0LK21</b>

##### With M12 connector socket, 4-pole (250 V, 4 A)

Snap-action contacts, integrated <sup>3)</sup>	1 NO + 1 NC --	⊕ B	<b>3SE5 234-0HK21-1AC4</b>
--	----------------	-----	----------------------------

##### With metal lever 35 mm and plastic roller 19 mm

Snap-action contacts, integrated <sup>3)</sup>	1 NO + 1 NC --	⊕ B	<b>3SE5 232-0HK15</b>
--	----------------	-----	-----------------------

#### Twist levers, adjustable length

##### With metal lever with grid hole and plastic roller 19 mm

Snap-action contacts, integrated <sup>3)</sup>	1 NO + 1 NC --	⊕ A	<b>3SE5 232-0HK60</b>
--	----------------	-----	-----------------------



Twist lever, adjustable length

*Note: If the device you require is not available as a complete unit, see "Modular system" on the next page.*

⊕ Positive opening according to IEC 60947-5-1, Appendix K.

<sup>1)</sup> A cable gland with seal must be used with the quick-connect method.

<sup>2)</sup> Popular versions.





<sup>3)</sup> Subsequent replacement of contact blocks is not possible.



3SE5, molded-plastic enclosures  
Enclosure width 31 mm according to EN 50047

### Modular system

2 or 3 contacts · Degree of protection IP65 · Cable entry M20 × 1.5<sup>1)</sup>

Version	Contacts	LEDs	DT	Modular system
				Order No.
<b>Basic switches • Enclosure width 31 mm (with rounded plunger<sup>2)</sup>)</b>				
 Basic switch	<b>With teflon plunger</b>			
	Slow-action contacts	1 NO + 1 NC --	⊕ ▶	<b>3SE5 232-0BC05</b>
	Snap-action contacts	1 NO + 1 NC --	⊕ B	<b>3SE5 232-0CC05</b>
	Snap-action contacts, integrated <sup>3)</sup>	1 NO + 1 NC --	⊕ ▶	<b>3SE5 232-0HC05</b>
	Snap-action contacts • Short-stroke, integrated <sup>3)</sup>	1 NO + 1 NC --	⊕ B	<b>3SE5 232-0FC05</b>
	Snap-action contacts • 2 × 2 mm contact gap	1 NO + 1 NC --	⊕ B	<b>3SE5 232-0GC05</b>
	Slow-action contacts	1 NO + 2 NC --	⊕ A	<b>3SE5 232-0KC05</b>
	Snap-action contacts	1 NO + 2 NC --	⊕ A	<b>3SE5 232-0LC05</b>
	Slow-action contacts with make-before-break	1 NO + 2 NC --	⊕ A	<b>3SE5 232-0MC05</b>
Slow-action contacts	2 NO + 1 NC --	⊕ A	<b>3SE5 232-0PC05</b>	
 With increased corrosion protection	<b>With increased corrosion protection<sup>4)</sup></b>			
	Slow-action contacts	1 NO + 1 NC --	⊕ B	<b>3SE5 232-0BC05-1CA0</b>
	Snap-action contacts	1 NO + 1 NC --	⊕ B	<b>3SE5 232-0CC05-1CA0</b>
	Slow-action contacts	1 NO + 2 NC --	⊕ B	<b>3SE5 232-0KC05-1CA0</b>
	Snap-action contacts	1 NO + 2 NC --	⊕ B	<b>3SE5 232-0LC05-1CA0</b>
	Slow-action contacts with make-before-break	1 NO + 2 NC --	⊕ B	<b>3SE5 232-0MC05-1CA0</b>
Slow-action contacts	2 NO + 1 NC --	⊕ B	<b>3SE5 232-0PC05-1CA0</b>	
 With M12 socket	<b>With M12 connector socket, 4-pole (250 V, 4 A)</b>			
	Slow-action contacts	1 NO + 1 NC --	⊕ B	<b>3SE5 234-0BC05-1AC4</b>
	Snap-action contacts, integrated <sup>3)</sup>	1 NO + 1 NC --	⊕ A	<b>3SE5 234-0HC05-1AC4</b>
	Slow-action contacts	2 NC --	⊕ B	<b>3SE5 234-0KC05-1AE0</b>
	Snap-action contacts	2 NC --	⊕ A	<b>3SE5 234-0LC05-1AE0</b>
 With 2 LEDs	<b>With 2 LEDs, yellow/green</b>			
	Slow-action contacts	1 NO + 2 NC 24 V DC	⊕ B	<b>3SE5 232-1KC05</b>
	Snap-action contacts	1 NO + 2 NC 24 V DC	⊕ B	<b>3SE5 232-1LC05</b>
	Slow-action contacts	1 NO + 2 NC 230 V AC	⊕ B	<b>3SE5 232-3KC05</b>
Snap-action contacts	1 NO + 2 NC 230 V AC	⊕ B	<b>3SE5 232-3LC05</b>	
 With M12 socket and 2 LEDs	<b>With M12 connector socket, 5-pole (125 V, 4 A) and 2 LEDs</b>			
	Slow-action contacts	1 NO + 1 NC 24 V DC	⊕ B	<b>3SE5 234-1BC05-1AF3</b>
	Snap-action contacts	1 NO + 1 NC 24 V DC	⊕ B	<b>3SE5 234-1CC05-1AF3</b>









⊕ Positive opening according to IEC 60947-5-1, Appendix K, or positively driven actuator, necessary in safety circuits.

- 1) A cable gland with seal must be used with the quick-connect method.
- 2) On the plastic version the basic switch is a complete unit with rounded plunger.
- 3) Subsequent replacement of contact blocks is not possible.
- 4) Use corresponding high-grade steel lever.

*Note: For selection assistance, see page 2/8.*

# 3SE5, 3SE2 position switches

## 3SE5, molded-plastic enclosures Enclosure width 31 mm according to EN 50047

Version	Diameter	DT	Modular system
	mm		Order No.
<b>Operating mechanisms</b>			
 Roller plunger	<b>Roller plungers, type C acc. to EN 50047</b>		
	Plastic rollers	10	⊕ A <b>3SE5 000-0AD03</b>
	High-grade steel rollers	10	⊕ B <b>3SE5 000-0AD04</b>
 With central fixing	<b>Roller plungers with central fixing</b>		
	Plastic rollers	10	⊕ B <b>3SE5 000-0AD10</b>
	High-grade steel rollers	10	⊕ B <b>3SE5 000-0AD11</b>
 Roller lever	<b>Roller levers, type E acc. to EN 50047</b>		
	Metal lever, plastic roller	13	⊕ A <b>3SE5 000-0AE10</b>
	Metal lever, high-grade steel roller	13	⊕ B <b>3SE5 000-0AE11</b>
	High-grade steel lever, plastic roller	13	⊕ B <b>3SE5 000-0AE12</b>
	High-grade steel lever, high-grade steel roller	13	⊕ B <b>3SE5 000-0AE13</b>
 Angular roller lever	<b>Angular roller levers</b>		
	Metal lever, plastic roller	13	⊕ A <b>3SE5 000-0AF10</b>
	Metal lever, high-grade steel roller	13	⊕ B <b>3SE5 000-0AF11</b>
	High-grade steel lever, plastic roller	13	⊕ A <b>3SE5 000-0AF12</b>
	High-grade steel lever, high-grade steel roller	13	⊕ B <b>3SE5 000-0AF13</b>
<b>Twist actuators</b>			
 Twist actuator	<b>Twist actuators, plastic (without lever)</b>		
	Switching right and/or left, adjustable		⊕ A <b>3SE5 000-0AK00</b>
<b>Levers for twist actuators</b>			
 Twist lever	<b>Twist levers 21 mm, straight, type A acc. to EN 50047</b>		
	Metal lever, plastic roller	19	⊕ A <b>3SE5 000-0AA21</b>
	Metal lever, high-grade steel roller	19	⊕ B <b>3SE5 000-0AA22</b>
	Metal lever, roller with ball bearing	19	⊕ B <b>3SE5 000-0AA23</b>
	Metal lever, plastic roller	30	⊕ B <b>3SE5 000-0AA25</b>
	High-grade steel lever, plastic roller	19	⊕ B <b>3SE5 000-0AA31</b>
	High-grade steel lever, high-grade steel roller	19	⊕ B <b>3SE5 000-0AA32</b>
 Twist levers 30 mm, straight <sup>1)</sup>	Metal lever, plastic roller		⊕ B <b>3SE5 000-0AA24</b>
	<b>Twist levers, adjustable length, with grid hole</b>		
 Twist lever, adjustable length	Metal lever, plastic roller	19	⊕ B <b>3SE5 000-0AA60</b>
	Metal lever, high-grade steel roller	19	⊕ B <b>3SE5 000-0AA61</b>
	Metal lever, plastic roller	50	⊕ B <b>3SE5 000-0AA67</b>
	Metal lever, rubber roller	50	⊕ B <b>3SE5 000-0AA68</b>
	High-grade steel lever, plastic roller	19	⊕ B <b>3SE5 000-0AA62</b>
	High-grade steel lever, high-grade steel roller	19	⊕ B <b>3SE5 000-0AA63</b>





⊕ Positively driven actuator, necessary in safety circuits.

<sup>1)</sup> Can be clinch mounted (turned through 180°, rear of lever).

## Selection and ordering data

## Complete units

2 or 3 contacts · Degree of protection IP66/67 · Cable entry M20 × 1.5

Version	Contacts	LEDs	DT	Complete units
				Order No. <input type="checkbox"/>
<b>Complete units<sup>1)</sup> · Enclosure width 40 mm</b>				
<b>Plain plungers</b>				
<b>With high-grade steel plunger</b>				
 Plain plunger	Slow-action contacts	1 NO + 1 NC --	⊕ A	3SE5 132-0BB01
	Snap-action contacts	1 NO + 1 NC --	⊕ A	3SE5 132-0CB01
	Slow-action contacts	1 NO + 2 NC --	⊕ B	3SE5 132-0KB01
	Snap-action contacts	1 NO + 2 NC --	⊕ B	3SE5 132-0LB01
	Slow-action contacts	2 NO + 1 NC --	⊕ B	3SE5 132-0PB01
<b>Rounded plungers, type B acc. to EN 50041</b>				
<b>With plastic plunger</b>				
 Rounded plunger	Slow-action contacts	1 NO + 1 NC --	⊕ B	3SE5 132-0BC03
	Snap-action contacts	1 NO + 1 NC --	⊕ A	3SE5 132-0CC03
	Slow-action contacts	1 NO + 2 NC --	⊕ B	3SE5 132-0KC03
	Snap-action contacts	1 NO + 2 NC --	⊕ A	3SE5 132-0LC03
	Slow-action contacts	2 NO + 1 NC --	⊕ B	3SE5 132-0PC03
<b>Roller plungers, type C acc. to EN 50041</b>				
<b>With plastic roller 13 mm</b>				
 Roller plunger	Slow-action contacts	1 NO + 1 NC --	⊕ B	3SE5 132-0BD05
	Snap-action contacts	1 NO + 1 NC --	⊕ B	3SE5 132-0CD05
	Slow-action contacts	1 NO + 2 NC --	⊕ B	3SE5 132-0KD05
	Snap-action contacts	1 NO + 2 NC --	⊕ B	3SE5 132-0LD05
	Slow-action contacts	2 NO + 1 NC --	⊕ B	3SE5 132-0PD05
<b>Roller levers</b>				
<b>With metal lever and plastic roller 22 mm</b>				
 Roller lever	Slow-action contacts	1 NO + 1 NC --	⊕ B	3SE5 132-0BE05
	Snap-action contacts	1 NO + 1 NC --	⊕ B	3SE5 132-0CE05
	Slow-action contacts	1 NO + 2 NC --	⊕ B	3SE5 132-0KE05
	Snap-action contacts	1 NO + 2 NC --	⊕ B	3SE5 132-0LE05
	Slow-action contacts	2 NO + 1 NC --	⊕ B	3SE5 132-0PE05
<b>Angular roller levers</b>				
<b>With metal lever and plastic roller 22 mm</b>				
 Angular roller lever	Slow-action contacts	1 NO + 1 NC --	⊕ B	3SE5 132-0BF05
	Snap-action contacts	1 NO + 1 NC --	⊕ B	3SE5 132-0CF05
	Snap-action contacts	1 NO + 2 NC --	⊕ B	3SE5 132-0LF05

⊕ Positive opening according to IEC 60947-5-1, Appendix K.

1) Popular versions.

# 3SE5, 3SE2 position switches

## 3SE5, molded-plastic enclosures Enclosure width 40 mm according to EN 50041

2 or 3 contacts · Degree of protection IP66 / IP67 · Cable entry M20 × 1.5

Version	Contacts	LEDs	DT	Complete units
				Order No. <input type="checkbox"/>

### Complete units<sup>1)</sup> • Enclosure width 40 mm



Twist lever

#### Twist levers, type A acc. to EN 50041

##### With metal lever 27 mm and plastic roller 19 mm

Slow-action contacts	1 NO + 1 NC --	⊕ B	B	<b>3SE5 132-0BJ01</b>
Snap-action contacts	1 NO + 1 NC --	⊕ A	A	<b>3SE5 132-0CJ01</b>
Slow-action contacts	1 NO + 2 NC --	⊕ B	B	<b>3SE5 132-0KJ01</b>
Snap-action contacts	1 NO + 2 NC --	⊕ B	B	<b>3SE5 132-0LJ01</b>
Slow-action contacts	2 NO + 1 NC --	⊕ B	B	<b>3SE5 132-0PJ01</b>



Twist lever,  
adjustable  
length, with  
grid hole

#### Twist levers, adjustable length

##### With metal lever with grid hole and plastic roller 19 mm

Snap-action contacts	1 NO + 1 NC --	⊕ B	B	<b>3SE5 132-0CJ60</b>
Snap-action contacts	1 NO + 2 NC --	⊕ B	B	<b>3SE5 132-0LJ60</b>

⊕ Positive opening according to IEC 60947-5-1, Appendix K.





<sup>1)</sup> Popular versions.

*Note: If the device you require is not available as a complete unit, see "Modular system" on the next page.*

3SE5, molded-plastic enclosures  
Enclosure width 40 mm according to EN 50041

### Modular system

2 or 3 contacts · Degree of protection IP66 / IP67 · Cable entry M20 × 1.5

Version	Contacts	LEDs	DT	Modular system	Order No.
<b>Basic switches · Enclosure width 40 mm</b>					
 Basic switch	<b>With M20 × 1.5 connecting thread</b>				
	Slow-action contacts	1 NO + 1 NC --		⊕ A	<b>3SE5 132-0BA00</b>
	Snap-action contacts	1 NO + 1 NC --		⊕ A	<b>3SE5 132-0CA00</b>
	• Gold-plated contacts			⊕ B	<b>3SE5 132-0CA00-1AC1</b>
	Slow-action contacts	1 NO + 2 NC --		⊕ A	<b>3SE5 132-0KA00</b>
	Snap-action contacts	1 NO + 2 NC --		⊕ A	<b>3SE5 132-0LA00</b>
	Slow-action contacts with make-before-break	1 NO + 2 NC --		⊕ A	<b>3SE5 132-0MA00</b>
	Slow-action contacts	2 NO + 1 NC --		⊕ A	<b>3SE5 132-0PA00</b>
 With increased corrosion protection	<b>With increased corrosion protection<sup>1)</sup></b>				
	Slow-action contacts	1 NO + 1 NC --		⊕ B	<b>3SE5 132-0BA00-1CA0</b>
	Snap-action contacts	1 NO + 1 NC --		⊕ B	<b>3SE5 132-0CA00-1CA0</b>
	Slow-action contacts	1 NO + 2 NC --		⊕ B	<b>3SE5 132-0KA00-1CA0</b>
	Snap-action contacts	1 NO + 2 NC --		⊕ B	<b>3SE5 132-0LA00-1CA0</b>
	Slow-action contacts with make-before-break	1 NO + 2 NC --		⊕ B	<b>3SE5 132-0MA00-1CA0</b>
 With M12 socket	<b>With M12 connector socket, 4-pole (250 V, 4 A)</b>				
	Slow-action contacts	1 NO + 1 NC --		⊕ B	<b>3SE5 134-0BA00-1AC4</b>
	Snap-action contacts	1 NO + 1 NC --		⊕ B	<b>3SE5 134-0CA00-1AC4</b>
	Slow-action contacts	2 NC --		⊕ B	<b>3SE5 134-0KA00-1AE0</b>
	Snap-action contacts	2 NC --		⊕ B	<b>3SE5 134-0LA00-1AE0</b>
 With 2 LEDs	<b>With 2 LEDs, yellow/green</b>				
	Slow-action contacts	1 NO + 2 NC	24 V DC	⊕ B	<b>3SE5 132-1KA00</b>
	Snap-action contacts	1 NO + 2 NC	24 V DC	⊕ B	<b>3SE5 132-1LA00</b>
	Slow-action contacts	1 NO + 2 NC	230 V AC	⊕ C	<b>3SE5 132-3KA00</b>
	Snap-action contacts	1 NO + 2 NC	230 V AC	⊕ C	<b>3SE5 132-3LA00</b>









⊕ Positive opening according to IEC 60947-5-1, Appendix K, or positively driven actuator, necessary in safety circuits.

<sup>1)</sup> Use corresponding high-grade steel lever.

*Note: For selection assistance, see page 2/8.*

# 3SE5, 3SE2 position switches

## 3SE5, molded-plastic enclosures Enclosure width 40 mm according to EN 50041

Version	Diameter	DT	Modular system
	mm		Order No.
<b>Operating mechanisms</b>			
 Plain plunger	<b>Plain plungers</b> High-grade steel plungers	10	⊕ A <b>3SE5 000-0AB01</b>
 Plunger	<b>Rounded plungers, type B acc. to EN 50041</b> Plastic plungers	10	⊕ A <b>3SE5 000-0AC03</b>
 Roller lever	<b>Roller plungers, type C acc. to EN 50041</b> High-grade steel lever, plastic roller Plastic plunger, high-grade steel roller	13 13	⊕ A <b>3SE5 000-0AD05</b> ⊕ A <b>3SE5 000-0AD06</b>
 Angular roller lever	<b>Roller levers</b> Metal lever with plastic roller, plastic base	22	⊕ A <b>3SE5 000-0AE05</b>
 Angular roller lever	<b>Angular roller levers</b> Metal lever with plastic roller, plastic base	22	⊕ A <b>3SE5 000-0AF05</b>
<b>Twist actuators</b>			
 Twist actuator	<b>Twist actuators</b> , plastic (without lever) • For twist levers and rod actuators, switching right and/or left, adjustable		⊕ A <b>3SE5 000-0AJ00</b>
 Twist lever	<b>Levers for twist actuators</b> <b>Twist levers, offset, type A acc. to EN 50041</b> Metal lever 27 mm, plastic roller Metal lever 27 mm, high-grade steel roller Metal lever 27 mm, roller with ball bearing Metal lever 27 mm, 2 plastic rollers Metal lever 27 mm, plastic roller Metal lever 27 mm, rubber roller High-grade steel lever 27 mm, plastic roller High-grade steel lever 27 mm, high-grade steel roller Metal lever 35 mm, plastic roller	19 19 19 19 30 50 19 19 19	⊕ A <b>3SE5 000-0AA01</b> ⊕ A <b>3SE5 000-0AA02</b> ⊕ B <b>3SE5 000-0AA03</b> ⊕ B <b>3SE5 000-0AA04</b> ⊕ B <b>3SE5 000-0AA05</b> ⊕ B <b>3SE5 000-0AA08</b> ⊕ B <b>3SE5 000-0AA11</b> ⊕ B <b>3SE5 000-0AA12</b> ⊕ B <b>3SE5 000-0AA15</b>
 Twist lever, adjustable length	<b>Twist levers 30 mm, straight<sup>1)</sup></b> Metal lever, plastic roller Metal lever, plastic roller	19 30	⊕ B <b>3SE5 000-0AA24</b> ⊕ B <b>3SE5 000-0AA26</b>
	<b>Twist levers, adjustable length, with grid hole</b> Metal lever, plastic roller Metal lever, high-grade steel roller Metal lever, rubber roller High-grade steel lever, plastic roller High-grade steel lever, high-grade steel roller	19 19 50 19 19	⊕ B <b>3SE5 000-0AA60</b> ⊕ B <b>3SE5 000-0AA61</b> ⊕ B <b>3SE5 000-0AA68</b> ⊕ B <b>3SE5 000-0AA62</b> ⊕ B <b>3SE5 000-0AA63</b>

⊕ Positively driven actuator, necessary in safety circuits.

<sup>1)</sup> Can be clinch mounted (turned through 180°, rear of lever).

## Selection and ordering data

## Complete units

2 or 3 contacts · Degree of protection IP66 / IP67 · Cable entry 2 × (M20 × 1.5)

Version	Contacts	LEDs	DT	Complete units
				<input type="checkbox"/>
				Order No.

Complete units<sup>1)</sup> • Enclosure width 50 mm

Rounded plunger

**Rounded plungers****With teflon plunger**

Slow-action contacts	1 NO + 1 NC --	⊕ A	<b>3SE5 242-0BC05</b>
Snap-action contacts	1 NO + 1 NC --	⊕ B	<b>3SE5 242-0CC05</b>
Snap-action contacts, integrated <sup>2)</sup>	1 NO + 1 NC --	⊕ ▶	<b>3SE5 242-0HC05</b>
Snap-action contacts • Short-stroke, integrated <sup>2)</sup>	1 NO + 1 NC --	⊕ B	<b>3SE5 242-0FC05</b>
Snap-action contacts • 2 × 2 mm contact gap	1 NO + 1 NC --	⊕ B	<b>3SE5 242-0GC05</b>
Slow-action contacts	1 NO + 2 NC --	⊕ B	<b>3SE5 242-0KC05</b>
Snap-action contacts	1 NO + 2 NC --	⊕ B	<b>3SE5 242-0LC05</b>
Slow-action contacts with make-before-break	1 NO + 2 NC --	⊕ A	<b>3SE5 242-0MC05</b>
Slow-action contacts	2 NO + 1 NC --	⊕ A	<b>3SE5 242-0PC05</b>



With increased corrosion protection

**With increased corrosion protection**

Slow-action contacts	1 NO + 1 NC --	⊕ B	<b>3SE5 242-0BC05-1CA0</b>
Snap-action contacts, integrated <sup>2)</sup>	1 NO + 1 NC --	⊕ B	<b>3SE5 242-0HC05-1CA0</b>
Slow-action contacts	1 NO + 2 NC --	⊕ B	<b>3SE5 242-0KC05-1CA0</b>
Snap-action contacts	1 NO + 2 NC --	⊕ B	<b>3SE5 242-0LC05-1CA0</b>
Slow-action contacts with make-before-break	1 NO + 2 NC --	⊕ B	<b>3SE5 242-0MC05-1CA0</b>
Slow-action contacts	2 NO + 1 NC --	⊕ B	<b>3SE5 242-0PC05-1CA0</b>



With 2 LEDs

**With 2 LEDs, yellow/green**

Slow-action contacts	1 NO + 2 NC 24 V DC	⊕ B	<b>3SE5 242-1KC05</b>
Snap-action contacts	1 NO + 2 NC 24 V DC	⊕ B	<b>3SE5 242-1LC05</b>
Slow-action contacts	1 NO + 2 NC 230 V AC	⊕ B	<b>3SE5 242-3KC05</b>
Snap-action contacts	1 NO + 2 NC 230 V AC	⊕ B	<b>3SE5 242-3LC05</b>



Roller plunger

**Roller plungers****With plastic roller 10 mm**

Slow-action contacts	1 NO + 1 NC --	⊕ B	<b>3SE5 242-0BD03</b>
Snap-action contacts, integrated <sup>2)</sup>	1 NO + 1 NC --	⊕ B	<b>3SE5 242-0HD03</b>
Snap-action contacts	1 NO + 2 NC --	⊕ B	<b>3SE5 242-0LD03</b>

⊕ Positive opening according to IEC 60947-5-1, Appendix K.

1) Popular versions.

2) Subsequent replacement of contact blocks is not possible.

# 3SE5, 3SE2 position switches

## 3SE5, molded-plastic enclosures Enclosure width 50 mm

2 or 3 contacts · Degree of protection IP66 / IP67 · Cable entry 2 × (M20 × 1.5)

Version	Contacts	LEDs	DT	Complete units
				<input type="checkbox"/>
				Order No.

### Complete units<sup>1)</sup> · Enclosure width 50 mm



Roller lever

#### Roller levers

##### With metal lever and plastic roller 13 mm

Slow-action contacts	1 NO + 1 NC --	⊕ B	B	<b>3SE5 242-0BE10</b>
Snap-action contacts, integrated <sup>2)</sup>	1 NO + 1 NC --	⊕ A	A	<b>3SE5 242-0HE10</b>
Snap-action contacts	1 NO + 2 NC --	⊕ B	B	<b>3SE5 242-0LE10</b>

##### With M12 connector socket, 4-pole right (250 V, 4 A)

Snap-action contacts	2 NC	⊕ B	B	<b>3SE5 244-0LE10-1AE0</b>
----------------------	------	-----	---	----------------------------

#### Twist levers

##### With metal lever 21 mm and plastic roller 19 mm

Slow-action contacts	1 NO + 1 NC --	⊕ B	B	<b>3SE5 242-0BK21</b>
Snap-action contacts, integrated <sup>2)</sup>	1 NO + 1 NC --	⊕ B	B	<b>3SE5 242-0HK21</b>
Snap-action contacts	1 NO + 2 NC --	⊕ B	B	<b>3SE5 242-0LK21</b>



Twist lever

⊕ Positive opening according to IEC 60947-5-1, Appendix K.

<sup>1)</sup> Popular versions.

<sup>2)</sup> Subsequent replacement of contact blocks is not possible.

*Note: If the device you require is not available as a complete unit, see "Modular system".*

### Modular system

2 or 3 contacts · Degree of protection IP66 / IP67 · Cable entry 2 × (M20 × 1.5)

Version	Contacts	LEDs	DT	Modular system
				<input type="checkbox"/>
				Order No.

### Basic switches · Enclosure width 50 mm (with rounded plunger<sup>1)</sup>)



Basic switch

#### With teflon plunger

Slow-action contacts	1 NO + 1 NC --	⊕ A	A	<b>3SE5 242-0BC05</b>
Snap-action contacts	1 NO + 1 NC --	⊕ B	B	<b>3SE5 242-0CC05</b>
Snap-action contacts, integrated <sup>2)</sup>	1 NO + 1 NC --	⊕ ▶	▶	<b>3SE5 242-0HC05</b>
Snap-action contacts • Short-stroke, integrated <sup>2)</sup>	1 NO + 1 NC --	⊕ B	B	<b>3SE5 242-0FC05</b>
Snap-action contacts • 2 × 2 mm contact gap	1 NO + 1 NC --	⊕ B	B	<b>3SE5 242-0GC05</b>
Slow-action contacts	1 NO + 2 NC --	⊕ B	B	<b>3SE5 242-0KC05</b>
Snap-action contacts	1 NO + 2 NC --	⊕ B	B	<b>3SE5 242-0LC05</b>
Slow-action contacts with make-before-break	1 NO + 2 NC --	⊕ A	A	<b>3SE5 242-0MC05</b>
Slow-action contacts	2 NO + 1 NC --	⊕ A	A	<b>3SE5 242-0PC05</b>



With increased  
corrosion  
protection

#### With increased corrosion protection<sup>3)</sup>

Slow-action contacts	1 NO + 1 NC --	⊕ B	B	<b>3SE5 242-0BC05-1CA0</b>
Snap-action contacts, integrated <sup>2)</sup>	1 NO + 1 NC --	⊕ B	B	<b>3SE5 242-0HC05-1CA0</b>
Slow-action contacts	1 NO + 2 NC --	⊕ B	B	<b>3SE5 242-0KC05-1CA0</b>
Snap-action contacts	1 NO + 2 NC --	⊕ B	B	<b>3SE5 242-0LC05-1CA0</b>
Slow-action contacts with make-before-break	1 NO + 2 NC --	⊕ B	B	<b>3SE5 242-0MC05-1CA0</b>
Slow-action contacts	2 NO + 1 NC --	⊕ B	B	<b>3SE5 242-0PC05-1CA0</b>



With 2 LEDs

#### With 2 LEDs, yellow/green

Slow-action contacts	1 NO + 2 NC	24 V DC	⊕ B	B	<b>3SE5 242-1KC05</b>
Snap-action contacts	1 NO + 2 NC	24 V DC	⊕ B	B	<b>3SE5 242-1LC05</b>
Slow-action contacts	1 NO + 2 NC	230 V AC	⊕ B	B	<b>3SE5 242-3KC05</b>
Snap-action contacts	1 NO + 2 NC	230 V AC	⊕ B	B	<b>3SE5 242-3LC05</b>

⊕ Positive opening according to IEC 60947-5-1, Appendix K, or positively driven actuator, necessary in safety circuits.







<sup>1)</sup> On the plastic version the basic switch is a complete unit with rounded plunger.

<sup>2)</sup> Subsequent replacement of contact blocks is not possible.

<sup>3)</sup> Use corresponding high-grade steel lever.

*Note: For selection assistance, see page 2/8.*



Version	Diameter	DT	Modular system
			Order No.
			mm
<b>Operating mechanisms</b>			
 Roller plunger	<b>Roller plungers, type C acc. to EN 50047</b>		
	Plastic rollers	10	⊕ A 3SE5 000-0AD03
	High-grade steel rollers	10	⊕ B 3SE5 000-0AD04
 With central fixing	<b>Roller plungers with central fixing</b>		
	Plastic rollers	10	⊕ B 3SE5 000-0AD10
	High-grade steel rollers	10	⊕ B 3SE5 000-0AD11
 Roller lever	<b>Roller levers, type E acc. to EN 50047</b>		
	Metal lever, plastic roller	13	⊕ A 3SE5 000-0AE10
	Metal lever, high-grade steel roller	13	⊕ B 3SE5 000-0AE11
	High-grade steel lever, plastic roller	13	⊕ B 3SE5 000-0AE12
	High-grade steel lever, high-grade steel roller	13	⊕ B 3SE5 000-0AE13
 Angular roller lever	<b>Angular roller levers</b>		
	Metal lever, plastic roller	13	⊕ A 3SE5 000-0AF10
	Metal lever, high-grade steel roller	13	⊕ B 3SE5 000-0AF11
	High-grade steel lever, plastic roller	13	⊕ A 3SE5 000-0AF12
	High-grade steel lever, high-grade steel roller	13	⊕ B 3SE5 000-0AF13
<b>Twist actuators</b>			
 Twist actuator	<b>Twist actuators, plastic (without lever)</b>		
	Switching right and/or left, adjustable		⊕ A 3SE5 000-0AK00
<b>Levers for twist actuators</b>			
 Twist lever	<b>Twist levers 21 mm, straight, type A acc. to EN 50047</b>		
	Metal lever, plastic roller	19	⊕ A 3SE5 000-0AA21
	Metal lever, high-grade steel roller	19	⊕ B 3SE5 000-0AA22
	Metal lever, roller with ball bearing	19	⊕ B 3SE5 000-0AA23
	Metal lever, plastic roller	30	⊕ B 3SE5 000-0AA25
	High-grade steel lever, plastic roller	19	⊕ B 3SE5 000-0AA31
	High-grade steel lever, high-grade steel roller	19	⊕ B 3SE5 000-0AA32
 Twist lever, adjustable length	<b>Twist levers 30 mm, straight<sup>1)</sup></b>		
	Metal lever, plastic roller	19	⊕ B 3SE5 000-0AA24
	Metal lever, plastic roller	30	⊕ B 3SE5 000-0AA26
	<b>Twist levers, adjustable length, with grid hole</b>		
	Metal lever, plastic roller	19	⊕ B 3SE5 000-0AA60
	Metal lever, high-grade steel roller	19	⊕ B 3SE5 000-0AA61
	Metal lever, plastic roller	50	⊕ B 3SE5 000-0AA67
	Metal lever, rubber roller	50	⊕ B 3SE5 000-0AA68
	High-grade steel lever, plastic roller	19	⊕ B 3SE5 000-0AA62
	High-grade steel lever, high-grade steel roller	19	⊕ B 3SE5 000-0AA63

⊕ Positively driven actuator, necessary in safety circuits.

<sup>1)</sup> Can be clinch mounted (turned through 180°, rear of lever).

# 3SE5, 3SE2 position switches

**3SE5, molded-plastic enclosures**  
Ambient temperature up to  $-40\text{ °C}$

## Selection and ordering data

### Complete units

2 or 3 contacts · Degree of protection IP65 or IP66 / IP67 · Cable entry M20 × 1.5

Version	Contacts	LEDs	DT	Complete units
				<input type="checkbox"/>
				Order No.

### Complete units<sup>1)</sup> • Enclosure width 31 mm



Twist lever

#### Twist levers, type A acc. to EN 50047

**With high-grade steel lever 21 mm and plastic roller 19 mm**

Snap-action contacts                      1 NO + 1 NC --                      ⤴ A    **3SE5 232-0CK31-1AJ0**



Twist lever,  
adjustable  
length

#### Twist levers, adjustable length

**With high-grade steel lever with grid hole and plastic roller 19 mm**

Snap-action contacts                      1 NO + 1 NC --                      ⤴ A    **3SE5 232-0CK62-1AJ0**

Snap-action contacts                      1 NO + 2 NC --                      ⤴ B    **3SE5 232-0LK62-1AJ0**

### Complete units<sup>1)</sup> • Enclosure width 50 mm

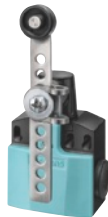

Twist lever,  
adjustable  
length

#### Twist levers

**With metal lever 21 mm and plastic roller 19 mm**

Snap-action contacts, integrated<sup>2)</sup> 1 NO + 1 NC --                      ⤴ B    **3SE5 242-0HK21-1AJ0**

#### Twist levers, adjustable length

**With high-grade steel lever with grid hole and plastic roller 19 mm**

Snap-action contacts, integrated<sup>2)</sup> 1 NO + 1 NC --                      ⤴ B    **3SE5 242-0HK62-1AJ0**

### Modular system

2 or 3 contacts · Degree of protection IP65 or IP66 / IP67 · Cable entry M20 × 1.5

Version	Contacts	LEDs	DT	Modular system
				<input type="checkbox"/>
				Order No.

### Basic switches • Enclosure width 31 mm (with rounded plunger<sup>1)</sup>)



Basic switch

#### With teflon plunger

Snap-action contacts                      1 NO + 1 NC --                      ⤴ B    **3SE5 232-0CC05-1AJ0**

Slow-action contacts                      1 NO + 2 NC --                      ⤴ B    **3SE5 232-0KC05-1AJ0**

Snap-action contacts                      1 NO + 2 NC --                      ⤴ B    **3SE5 232-0LC05-1AJ0**

### Basic switches • Enclosure width 50 mm (with rounded plunger<sup>1)</sup>)



Basic switch

#### With teflon plunger

Slow-action contacts                      1 NO + 1 NC --                      ⤴ B    **3SE5 242-0BC05-1AJ0**

Snap-action contacts, integrated<sup>2)</sup> 1 NO + 1 NC --                      ⤴ B    **3SE5 242-0HC05-1AJ0**







⤴ Positive opening according to IEC 60947-5-1, Appendix K, or positively driven actuator, necessary in safety circuits.

<sup>1)</sup> On the plastic version the basic switch is a complete unit with rounded plunger.

<sup>2)</sup> Subsequent replacement of contact blocks is not possible.

*Note: For selection assistance, see page 2/8.*

3SE5, molded-plastic enclosures  
Ambient temperature up to -40 °C

Version	Diameter	DT	Modular system
	mm		Order No.
<b>Operating mechanisms</b>			
	<b>Roller plungers, type C acc. to EN 50047</b> Plastic rollers	10	⊕ B
Roller plunger			<b>3SE5 000-0AD03-1AJ0</b>
	<b>Roller levers, type E acc. to EN 50047</b> Metal lever, plastic roller High-grade steel lever, plastic roller	13 13	⊕ B ⊕ B
Roller lever			<b>3SE5 000-0AE10-1AJ0</b> <b>3SE5 000-0AE12-1AJ0</b>
	<b>Angular roller levers</b> Metal lever, plastic roller High-grade steel lever, plastic roller	13 13	⊕ B ⊕ B
Angular roller lever			<b>3SE5 000-0AF10-1AJ0</b> <b>3SE5 000-0AF12-1AJ0</b>
<b>Twist actuators</b>			
	<b>Twist actuators, plastic (without lever)</b> Switching right and/or left, adjustable		⊕ B
Twist actuator			<b>3SE5 000-0AK00-1AJ0</b>
<b>Levers for twist actuators</b>			
	<b>Twist levers straight, 21 mm, type A acc. to EN 50047</b> Metal lever, plastic roller High-grade steel lever, plastic roller	19 19	⊕ B ⊕ B
Twist lever			<b>3SE5 000-0AA21-1AJ0</b> <b>3SE5 000-0AA31-1AJ0</b>
	<b>Twist levers, adjustable length, with grid hole</b> Metal lever, plastic roller High-grade steel lever, plastic roller	19 19	⊕ B ⊕ B
Twist lever, adjustable length			<b>3SE5 000-0AA60-1AJ0</b> <b>3SE5 000-0AA62-1AJ0</b>

⊕ Positively driven actuator, necessary in safety circuits.

# 3SE5, 3SE2 position switches

## 3SE5, metal enclosures Enclosure width 31 mm according to EN 50047

### Selection and ordering data

#### Complete units

2 or 3 contacts · Degree of protection IP66 / IP67 · Cable entry M20 × 1.5

Version	Contacts	LEDs	DT	Complete units
				Order No. <input type="text"/>

#### Complete units<sup>1)</sup> • Enclosure width 31 mm

##### Rounded plungers, type B, acc. to EN 50047

###### With plunger

Slow-action contacts	1 NO + 1 NC --	⊕ A	<b>3SE5 212-0BC05</b>
Snap-action contacts	1 NO + 1 NC --	⊕ A	<b>3SE5 212-0CC05</b>
Slow-action contacts	1 NO + 2 NC --	⊕ A	<b>3SE5 212-0KC05</b>
Snap-action contacts	1 NO + 2 NC --	⊕ A	<b>3SE5 212-0LC05</b>
Slow-action contacts with make-before-break	1 NO + 2 NC --	⊕ A	<b>3SE5 212-0MC05</b>
Slow-action contacts	2 NO + 1 NC --	⊕ A	<b>3SE5 212-0PC05</b>

###### With increased corrosion protection

Slow-action contacts	1 NO + 1 NC --	⊕ B	<b>3SE5 212-0BC05-1CA0</b>
Snap-action contacts	1 NO + 1 NC --	⊕ B	<b>3SE5 212-0CC05-1CA0</b>
Slow-action contacts	1 NO + 2 NC --	⊕ B	<b>3SE5 212-0KC05-1CA0</b>
Snap-action contacts	1 NO + 2 NC --	⊕ B	<b>3SE5 212-0LC05-1CA0</b>
Slow-action contacts with make-before-break	1 NO + 2 NC --	⊕ B	<b>3SE5 212-0MC05-1CA0</b>
Slow-action contacts	2 NO + 1 NC --	⊕ B	<b>3SE5 212-0PC05-1CA0</b>

###### With M12 connector socket, 5-pole (125 V, 4 A)

Slow-action contacts	1 NO + 1 NC --	⊕ B	<b>3SE5 214-0BC05-1AC5</b>
Snap-action contacts	1 NO + 1 NC --	⊕ B	<b>3SE5 214-0CC05-1AC5</b>
Slow-action contacts	2 NC --	⊕ B	<b>3SE5 214-0KC05-1AE1</b>
Snap-action contacts	2 NC --	⊕ B	<b>3SE5 214-0LC05-1AE1</b>

###### With 2 LEDs, yellow/green

Slow-action contacts	1 NO + 2 NC 24 V DC	⊕ B	<b>3SE5 212-1KC05</b>
Snap-action contacts	1 NO + 2 NC 24 V DC	⊕ A	<b>3SE5 212-1LC05</b>
Slow-action contacts	1 NO + 2 NC 230 V AC	⊕ B	<b>3SE5 212-3KC05</b>
Snap-action contacts	1 NO + 2 NC 230 V AC	⊕ B	<b>3SE5 212-3LC05</b>

###### With M12 connector socket, 5-pole (125 V, 4 A) and 2 LEDs

Slow-action contacts	1 NO + 1 NC 24 V DC	⊕ B	<b>3SE5 214-1BC05-1AF3</b>
Snap-action contacts	1 NO + 1 NC 24 V DC	⊕ B	<b>3SE5 214-1CC05-1AF3</b>

##### Plain plungers

###### With high-grade steel plunger

Slow-action contacts	1 NO + 1 NC --	⊕ B	<b>3SE5 212-0BB01</b>
Snap-action contacts	1 NO + 1 NC --	⊕ B	<b>3SE5 212-0CB01</b>
Slow-action contacts	1 NO + 2 NC --	⊕ B	<b>3SE5 212-0KB01</b>
Snap-action contacts	1 NO + 2 NC --	⊕ B	<b>3SE5 212-0LB01</b>

##### Roller plungers, type C acc. to EN 50047

###### With plastic roller 10 mm

Slow-action contacts	1 NO + 1 NC --	⊕ A	<b>3SE5 212-0BD03</b>
Snap-action contacts	1 NO + 1 NC --	⊕ B	<b>3SE5 212-0CD03</b>
Slow-action contacts	1 NO + 2 NC --	⊕ A	<b>3SE5 212-0KD03</b>
Snap-action contacts	1 NO + 2 NC --	⊕ B	<b>3SE5 212-0LD03</b>



Rounded plunger



With increased corrosion protection



With 2 LEDs



Plain plunger



Roller plunger

⊕ Positive opening according to IEC 60947-5-1, Appendix K.

<sup>1)</sup> Popular versions.

2 or 3 contacts · Degree of protection IP66 / IP67 · Cable entry M20 × 1.5

Version	Contacts	LEDs	DT	Complete units
				<input type="checkbox"/>
				Order No.

Complete units<sup>1)</sup> • Enclosure width 31 mm

Roller lever

**Roller levers, type E acc. to EN 50047****With metal lever and plastic roller 13 mm**

Slow-action contacts	1 NO + 1 NC --	⊕ A	<b>3SE5 212-0BE10</b>
Snap-action contacts	1 NO + 1 NC --	⊕ B	<b>3SE5 212-0CE10</b>
Slow-action contacts	1 NO + 2 NC --	⊕ B	<b>3SE5 212-0KE10</b>
Snap-action contacts	1 NO + 2 NC --	⊕ B	<b>3SE5 212-0LE10</b>

**Angular roller levers****With metal lever and plastic roller 13 mm**

Slow-action contacts	1 NO + 1 NC --	⊕ B	<b>3SE5 212-0BF10</b>
Snap-action contacts	1 NO + 1 NC --	⊕ B	<b>3SE5 212-0CF10</b>
Slow-action contacts	1 NO + 2 NC --	⊕ B	<b>3SE5 212-0KF10</b>
Snap-action contacts	1 NO + 2 NC --	⊕ B	<b>3SE5 212-0LF10</b>



Angular roller lever

**Twist levers, type A acc. to EN 50047****With metal lever 21 mm and plastic roller 19 mm**

Slow-action contacts	1 NO + 1 NC --	⊕ A	<b>3SE5 212-0BK21</b>
Snap-action contacts	1 NO + 1 NC --	⊕ A	<b>3SE5 212-0CK21</b>
Slow-action contacts	1 NO + 2 NC --	⊕ B	<b>3SE5 212-0KK21</b>
Snap-action contacts	1 NO + 2 NC --	⊕ B	<b>3SE5 212-0LK21</b>



Twist lever

**Twist levers, adjustable length****With metal lever with grid hole and plastic roller 19 mm**

Snap-action contacts	1 NO + 1 NC --	⊕ A	<b>3SE5 212-0CK60</b>
Slow-action contacts	1 NO + 2 NC --	⊕ B	<b>3SE5 212-0KK60</b>
Snap-action contacts	1 NO + 2 NC --	⊕ B	<b>3SE5 212-0LK60</b>



Twist lever, adjustable length

⊕ Positive opening according to IEC 60947-5-1, Appendix K.







<sup>1)</sup> Popular versions.*Note: If the device you require is not available as a complete unit, see "Modular system" on the next page.*

# 3SE5, 3SE2 position switches

## 3SE5, metal enclosures Enclosure width 31 mm according to EN 50047

### Modular system

2 or 3 contacts · Degree of protection IP66 / IP67 · Cable entry M20 × 1.5



Version	Contacts	LEDs	DT	Modular system
				Order No. 
<b>Basic switches • Enclosure width 31 mm (with rounded plunger<sup>1)</sup>)</b>				
	<b>With plunger</b>			
	Slow-action contacts	1 NO + 1 NC --	⊕ A	<b>3SE5 212-0BC05</b>
	Snap-action contacts	1 NO + 1 NC --	⊕ A	<b>3SE5 212-0CC05</b>
	Slow-action contacts	1 NO + 2 NC --	⊕ A	<b>3SE5 212-0KC05</b>
	Snap-action contacts	1 NO + 2 NC --	⊕ A	<b>3SE5 212-0LC05</b>
	Slow-action contacts with make-before-break	1 NO + 2 NC --	⊕ A	<b>3SE5 212-0MC05</b>
Slow-action contacts	2 NO + 1 NC --	⊕ A	<b>3SE5 212-0PC05</b>	
	<b>With increased corrosion protection<sup>2)</sup></b>			
	Slow-action contacts	1 NO + 1 NC --	⊕ B	<b>3SE5 212-0BC05-1CA0</b>
	Snap-action contacts	1 NO + 1 NC --	⊕ B	<b>3SE5 212-0CC05-1CA0</b>
	Slow-action contacts	1 NO + 2 NC --	⊕ B	<b>3SE5 212-0KC05-1CA0</b>
	Snap-action contacts	1 NO + 2 NC --	⊕ B	<b>3SE5 212-0LC05-1CA0</b>
	Slow-action contacts with make-before-break	1 NO + 2 NC --	⊕ B	<b>3SE5 212-0MC05-1CA0</b>
Slow-action contacts	2 NO + 1 NC --	⊕ B	<b>3SE5 212-0PC05-1CA0</b>	
	<b>With M12 connector socket, 5-pole (125 V, 4 A)</b>			
	Slow-action contacts	1 NO + 1 NC --	⊕ B	<b>3SE5 214-0BC05-1AC5</b>
	Snap-action contacts	1 NO + 1 NC --	⊕ B	<b>3SE5 214-0CC05-1AC5</b>
	Slow-action contacts	2 NC --	⊕ B	<b>3SE5 214-0KC05-1AE1</b>
	Snap-action contacts	2 NC --	⊕ B	<b>3SE5 214-0LC05-1AE1</b>
	<b>With 2 LEDs, yellow/green</b>			
	Slow-action contacts	1 NO + 2 NC 24 V DC	⊕ B	<b>3SE5 212-1KC05</b>
	Snap-action contacts	1 NO + 2 NC 24 V DC	⊕ A	<b>3SE5 212-1LC05</b>
	Slow-action contacts	1 NO + 2 NC 230 V AC	⊕ B	<b>3SE5 212-3KC05</b>
	Snap-action contacts	1 NO + 2 NC 230 V AC	⊕ B	<b>3SE5 212-3LC05</b>
	<b>With M12 connector socket, 5-pole (125 V, 4 A) and 2 LEDs</b>			
	Slow-action contacts	1 NO + 1 NC 24 V DC	⊕ B	<b>3SE5 214-1BC05-1AF3</b>
	Snap-action contacts	1 NO + 1 NC 24 V DC	⊕ B	<b>3SE5 214-1CC05-1AF3</b>







⊕ Positive opening according to IEC 60947-5-1, Appendix K, or positively driven actuator, necessary in safety circuits.

<sup>1)</sup> On enclosure width 31 mm the basic switch is a complete unit with rounded plunger.

<sup>2)</sup> Use appropriate high-grade steel lever.

*Note: For selection assistance, see page 2/8.*

Version	Diameter	DT	Modular system	
			Order No. 	
mm				
<b>Operating mechanisms</b>				
	<b>Plain plungers</b>			
	High-grade steel plungers	10	⊕ A	<b>3SE5 000-0AB01</b>
	<b>Roller plungers, type C acc. to EN 50047</b>			
	Plastic rollers	10	⊕ A	<b>3SE5 000-0AD03</b>
	High-grade steel rollers	10	⊕ B	<b>3SE5 000-0AD04</b>

Version	Diameter	DT	Modular system
	mm		Order No.
<b>Operating mechanisms</b>			
 With central fixing	<b>Roller plungers with central fixing</b>		
	Plastic rollers	10	⊕ B 3SE5 000-0AD10
	High-grade steel rollers	10	⊕ B 3SE5 000-0AD11
 Roller lever	<b>Roller levers, type E acc. to EN 50047</b>		
	Metal lever, plastic roller	13	⊕ A 3SE5 000-0AE10
	Metal lever, high-grade steel roller	13	⊕ B 3SE5 000-0AE11
	High-grade steel lever, plastic roller	13	⊕ B 3SE5 000-0AE12
	High-grade steel lever, high-grade steel roller	13	⊕ B 3SE5 000-0AE13
 Angular roller lever	<b>Angular roller levers</b>		
	Metal lever, plastic roller	13	⊕ A 3SE5 000-0AF10
	Metal lever, high-grade steel roller	13	⊕ B 3SE5 000-0AF11
	High-grade steel lever, plastic roller	13	⊕ A 3SE5 000-0AF12
	High-grade steel lever, high-grade steel roller	13	⊕ B 3SE5 000-0AF13
<b>Twist actuators</b>			
 Twist actuator	<b>Twist actuators, plastic (without lever)</b>		
	Switching right and/or left, adjustable		⊕ A 3SE5 000-0AK00
<b>Levers for twist actuators</b>			
 Twist lever	<b>Twist levers, straight, type A acc. to EN 50047</b>		
	Metal lever 21 mm, plastic roller	19	⊕ A 3SE5 000-0AA21
	Metal lever 21 mm, high-grade steel roller	19	⊕ B 3SE5 000-0AA22
	Metal lever 21 mm, roller with ball bearing	19	⊕ B 3SE5 000-0AA23
	Metal lever 21 mm, plastic roller	30	⊕ B 3SE5 000-0AA25
	High-grade steel lever 21 mm, plastic roller	19	⊕ B 3SE5 000-0AA31
	High-grade steel lever 21 mm, high-grade steel roller	19	⊕ B 3SE5 000-0AA32
 Twist lever, adjustable length	<b>Twist levers 30 mm, straight<sup>1)</sup></b>		
	Metal lever, plastic roller	19	⊕ B 3SE5 000-0AA24
	Metal lever, plastic roller	30	⊕ B 3SE5 000-0AA26
	<b>Twist levers, adjustable length, with grid hole</b>		
	Metal lever, plastic roller	19	⊕ B 3SE5 000-0AA60
	Metal lever, high-grade steel roller	19	⊕ B 3SE5 000-0AA61
Metal lever, plastic roller	50	⊕ B 3SE5 000-0AA67	
Metal lever, rubber roller	50	⊕ B 3SE5 000-0AA68	
High-grade steel lever, plastic roller	19	⊕ B 3SE5 000-0AA62	
High-grade steel lever, high-grade steel roller	19	⊕ B 3SE5 000-0AA63	

⊕ Positively driven actuator, necessary in safety circuits.

<sup>1)</sup> Can be clinch mounted (turned through 180°, rear of lever).

# 3SE5, 3SE2 position switches

## 3SE5, metal enclosures Enclosure width 40 mm according to EN 50041

### Selection and ordering data

#### Complete units

2 or 3 contacts · Degree of protection IP66 / IP67 · Cable entry M20 × 1.5

Version	Contacts	LEDs	DT	Complete units
				Order No. <input type="text"/>

#### Complete units<sup>1)</sup> • Enclosure width 40 mm



Plain plunger

##### Plain plungers

###### With high-grade steel plunger

Slow-action contacts	1 NO + 1 NC --	⊕ A	3SE5 112-0BB01
Snap-action contacts	1 NO + 1 NC --	⊕ A	3SE5 112-0CB01
Slow-action contacts	1 NO + 2 NC --	⊕ B	3SE5 112-0KB01
Snap-action contacts	1 NO + 2 NC --	⊕ B	3SE5 112-0LB01



Rounded plunger

##### Rounded plungers, type B acc. to EN 50041

###### With high-grade steel plungers, with 3 mm overtravel

Slow-action contacts	1 NO + 1 NC --	⊕ B	3SE5 112-0BC02
Snap-action contacts	1 NO + 1 NC --	⊕ ▶	3SE5 112-0CC02
Slow-action contacts	1 NO + 2 NC --	⊕ B	3SE5 112-0KC02
Snap-action contacts	1 NO + 2 NC --	⊕ B	3SE5 112-0LC02



Roller plunger

##### Roller plungers, type C acc. to EN 50041

###### With high-grade steel roller 13 mm, with 3 mm overtravel

Slow-action contacts	1 NO + 1 NC --	⊕ B	3SE5 112-0BD02
Snap-action contacts	1 NO + 1 NC --	⊕ ▶	3SE5 112-0CD02
Slow-action contacts	1 NO + 2 NC --	⊕ B	3SE5 112-0KD02
Snap-action contacts	1 NO + 2 NC --	⊕ B	3SE5 112-0LD02

###### With M12 connector socket, 5-pole (125 V, 4 A) and 2 LEDs

Snap-action contacts	1 NO + 1 NC 24 V DC	⊕ B	3SE5 114-1CD02-1AF3
----------------------	---------------------	-----	---------------------



Roller lever

##### Roller levers

###### With metal lever and plastic roller 22 mm

Slow-action contacts	1 NO + 1 NC --	⊕ B	3SE5 112-0BE01
Snap-action contacts	1 NO + 1 NC --	⊕ ▶	3SE5 112-0CE01
Slow-action contacts	1 NO + 2 NC --	⊕ B	3SE5 112-0KE01
Snap-action contacts	1 NO + 2 NC --	⊕ B	3SE5 112-0LE01



Angular roller lever

##### Angular roller levers

###### With metal lever and plastic roller 22 mm

Slow-action contacts	1 NO + 1 NC --	⊕ B	3SE5 112-0BF01
Snap-action contacts	1 NO + 1 NC --	⊕ A	3SE5 112-0CF01
Snap-action contacts	1 NO + 2 NC --	⊕ B	3SE5 112-0LF01

⊕ Positive opening according to IEC 60947-5-1, Appendix K.

<sup>1)</sup> Popular versions.



2 or 3 contacts · Degree of protection IP66 / IP67 · Cable entry M20 × 1.5

Version	Contacts	LEDs	DT	Complete units
				<input type="checkbox"/>
				Order No.

Complete units<sup>1)</sup> • Enclosure width 40 mm

Twist lever

**Twist levers, type A acc. to EN 50041****With metal lever 27 mm and plastic roller 19 mm**

Slow-action contacts	1 NO + 1 NC --	⊕ B	<b>3SE5 112-0BH01</b>
Snap-action contacts	1 NO + 1 NC --	⊕ ▶	<b>3SE5 112-0CH01</b>
Slow-action contacts	1 NO + 2 NC --	⊕ B	<b>3SE5 112-0KH01</b>
Snap-action contacts	1 NO + 2 NC --	⊕ B	<b>3SE5 112-0LH01</b>

**With M12 connector socket, 5-pole (125 V, 4 A)**

Snap-action contacts	1 NO + 1 NC --	⊕ A	<b>3SE5 114-0CH01-1AC5</b>
----------------------	----------------	-----	----------------------------

**With M12 connector socket, 5-pole (125 V, 4 A) and 2 LEDs**

Snap-action contacts	1 NO + 1 NC 24 V DC	⊕ B	<b>3SE5 114-1CH01-1AF3</b>
----------------------	---------------------	-----	----------------------------

**With metal lever 27 mm and high-grade steel roller 19 mm**

Slow-action contacts	1 NO + 1 NC --	⊕ B	<b>3SE5 112-0BH02</b>
Snap-action contacts	1 NO + 1 NC --	⊕ A	<b>3SE5 112-0CH02</b>

**With M12 connector socket, 5-pole (125 V, 4 A) and 2 LEDs**

Snap-action contacts	1 NO + 1 NC --	⊕ B	<b>3SE5 114-1CH02-1AF3</b>
----------------------	----------------	-----	----------------------------

**With metal lever 30 mm and plastic roller 19 mm**

Snap-action contacts	1 NO + 1 NC --	⊕ ▶	<b>3SE5 112-0CH24</b>
----------------------	----------------	-----	-----------------------

**Twist levers, adjustable length****With metal lever with grid hole and plastic roller 19 mm**

Slow-action contacts	1 NO + 1 NC --	⊕ B	<b>3SE5 112-0BH60</b>
Snap-action contacts	1 NO + 1 NC --	⊕ ▶	<b>3SE5 112-0CH60</b>
Snap-action contacts	1 NO + 2 NC --	⊕ B	<b>3SE5 112-0LH60</b>

Twist lever, adjustable length, with grid hole

**With M12 connector socket, 8-pole (30 V, 2 A) and 2 LEDs**

Snap-action contacts	1 NO + 2 NC 24 V DC	⊕ B	<b>3SE5 114-1LH50-1AD4</b>
----------------------	---------------------	-----	----------------------------

**Fork levers, latching****With metal lever and 2 plastic rollers 19 mm**

Snap-action contacts	1 NO + 1 NC --	⊕ B	<b>3SE5 112-0CT11</b>
----------------------	----------------	-----	-----------------------



Fork lever

⊕ Positive opening according to IEC 60947-5-1, Appendix K.

1) Popular versions.











*Note: If the device you require is not available as a complete unit, see "Modular system" on the next page.*

# 3SE5, 3SE2 position switches

## 3SE5, metal enclosures Enclosure width 40 mm according to EN 50041

### Modular system

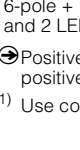





2 or 3 contacts · Degree of protection IP66 / IP67 · Cable entry M20 × 1.5

Version	Contacts	LEDs	DT	Modular system
				Order No. 
<b>Basic switches • Enclosure width 40 mm</b>				
 Basic switch	<b>With M20 × 1.5 connecting thread</b>			
	Slow-action contacts	1 NO + 1 NC --	⊕ B	<b>3SE5 112-0BA00</b>
	Snap-action contacts	1 NO + 1 NC --	⊕ A	<b>3SE5 112-0CA00</b>
	• Gold-plated contacts		⊕ B	<b>3SE5 112-0CA00-1AC1</b>
	Slow-action contacts	1 NO + 2 NC --	⊕ A	<b>3SE5 112-0KA00</b>
	Snap-action contacts	1 NO + 2 NC --	⊕ A	<b>3SE5 112-0LA00</b>
	Slow-action contacts with make-before-break	1 NO + 2 NC --	⊕ A	<b>3SE5 112-0MA00</b>
	Slow-action contacts	2 NO + 1 NC --	⊕ A	<b>3SE5 112-0PA00</b>
	 With increased corrosion protection	<b>With increased corrosion protection<sup>1)</sup></b>		
Slow-action contacts		1 NO + 1 NC --	⊕ B	<b>3SE5 112-0BA00-1CA0</b>
Snap-action contacts		1 NO + 1 NC --	⊕ B	<b>3SE5 112-0CA00-1CA0</b>
Slow-action contacts		1 NO + 2 NC --	⊕ B	<b>3SE5 112-0KA00-1CA0</b>
Snap-action contacts		1 NO + 2 NC --	⊕ B	<b>3SE5 112-0LA00-1CA0</b>
Slow-action contacts with make-before-break		1 NO + 2 NC --	⊕ B	<b>3SE5 112-0MA00-1CA0</b>
 With M12 socket	<b>With M12 connector socket, 5-pole (125 V, 4 A)</b>			
	Slow-action contacts	1 NO + 1 NC --	⊕ B	<b>3SE5 114-0BA00-1AC5</b>
	Snap-action contacts	1 NO + 1 NC --	⊕ B	<b>3SE5 114-0CA00-1AC5</b>
	Slow-action contacts	2 NC --	⊕ B	<b>3SE5 114-0KA00-1AE1</b>
 With connector socket, 6-pole + PE	<b>With connector socket, 6-pole + PE (250 V, 10 A)</b>			
	Snap-action contacts	2 NC --	⊕ B	<b>3SE5 114-0LA00-1AE1</b>
 With plug, 6-pole + PE	<b>With connector socket, 6-pole + PE (250 V, 10 A) and quick-release device</b>			
	Slow-action contacts	1 NO + 2 NC --	⊕ B	<b>3SE5 115-0KA00-1AD1</b>
 With connector socket, 6-pole + PE and quick-release device	<b>With connector socket, 6-pole + PE (250 V, 10 A) and quick-release device</b>			
	Snap-action contacts	1 NO + 2 NC --	⊕ B	<b>3SE5 115-0LA00-1AD1</b>
 With 2 LEDs	<b>With 2 LEDs, yellow/green</b>			
	Slow-action contacts	1 NO + 2 NC 24 V DC	⊕ B	<b>3SE5 112-1KA00</b>
	Snap-action contacts	1 NO + 2 NC 24 V DC	⊕ B	<b>3SE5 112-1LA00</b>
	Slow-action contacts	1 NO + 2 NC 230 V AC	⊕ B	<b>3SE5 112-3KA00</b>
 With M12 connector socket, 5-pole and 2 LEDs	<b>With M12 connector socket, 5-pole (125 V, 4 A) and 2 LEDs</b>			
	Snap-action contacts	1 NO + 2 NC 230 V AC	⊕ B	<b>3SE5 112-3LA00</b>
 With M12 connector socket, 8-pole and 2 LEDs	<b>With M12 connector socket, 8-pole (30 V, 2 A) and 2 LEDs</b>			
	Slow-action contacts	1 NO + 1 NC 24 V DC	⊕ B	<b>3SE5 114-1BA00-1AF3</b>
 With connector socket, 6-pole + PE and 2 LEDs	<b>With connector socket, 6-pole + PE (10 A), and 2 LEDs</b>			
	Snap-action contacts	1 NO + 1 NC 24 V DC	⊕ B	<b>3SE5 114-1CA00-1AF3</b>
	Snap-action contacts	1 NO + 1 NC 24 V DC	⊕ B	<b>3SE5 114-1CA00-1AF3</b>
 With socket, 6-pole + PE and 2 LEDs	<b>With connector socket, 6-pole + PE (10 A), and 2 LEDs</b>			
	Slow-action contacts	1 NO + 1 NC 24 V DC	⊕ B	<b>3SE5 115-1BA00-1AF2</b>
	Snap-action contacts	1 NO + 1 NC 24 V DC	⊕ B	<b>3SE5 115-1CA00-1AF2</b>
				<b>3SE5 115-1LA00-1AD2</b>

⊕ Positive opening according to IEC 60947-5-1, Appendix K, or positively driven actuator, necessary in safety circuits.

<sup>1)</sup> Use corresponding high-grade steel lever.

*Note: For selection assistance, see page 2/8.*

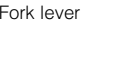
Version	Diameter	DT	Modular system	
	mm		Order No.	
<b>Operating mechanisms</b>				
	<b>Plain plungers</b> High-grade steel plungers	10	⊕ A	3SE5 000-0AB01
	<b>Rounded plungers, type B acc. to EN 50041</b> High-grade steel plungers, with 3 mm overtravel	10	⊕ B	3SE5 000-0AC02
	<b>Roller plungers, type C acc. to EN 50041</b> High-grade steel roller, with 3 mm overtravel	13	⊕ B	3SE5 000-0AD02
	<b>Roller levers</b> Metal lever, plastic roller	22	⊕ A	3SE5 000-0AE01
	Metal lever, high-grade steel roller	22	⊕ B	3SE5 000-0AE02
	High-grade steel lever, plastic roller	22	⊕ B	3SE5 000-0AE03
	High-grade steel lever, high-grade steel roller	22	⊕ B	3SE5 000-0AE04
	<b>Angular roller levers</b> Metal lever, plastic roller	22	⊕ A	3SE5 000-0AF01
	Metal lever, high-grade steel roller	22	⊕ B	3SE5 000-0AF02
	High-grade steel lever, plastic roller	22	⊕ B	3SE5 000-0AF03
	High-grade steel lever, high-grade steel roller	22	⊕ B	3SE5 000-0AF04
<b>Twist actuators</b>				
	<b>Twist actuators, metal (without lever)</b> • For twist levers and rod actuators, switching right and/or left, adjustable • For fork levers, latching		⊕ A	3SE5 000-0AH00
			⊕ B	3SE5 000-0AT10
<b>Levers for twist actuators</b>				
	<b>Twist levers, offset, type A acc. to EN 50041</b> Metal lever 27 mm, plastic roller	19	⊕ A	3SE5 000-0AA01
	Metal lever 27 mm, high-grade steel roller	19	⊕ A	3SE5 000-0AA02
	Metal lever 27 mm, roller with ball bearing	19	⊕ B	3SE5 000-0AA03
	Metal lever 27 mm, 2 plastic rollers	19	⊕ B	3SE5 000-0AA04
	Metal lever 27 mm, plastic roller	30	⊕ B	3SE5 000-0AA05
	Metal lever 27 mm, rubber roller	50	⊕ B	3SE5 000-0AA08
	High-grade steel lever 27 mm, plastic roller	19	⊕ B	3SE5 000-0AA11
	High-grade steel lever 27 mm, high-gr. steel roller	19	⊕ B	3SE5 000-0AA12
	Metal lever 35 mm, plastic roller	19	⊕ B	3SE5 000-0AA15
	<b>Twist levers 30 mm, straight<sup>1)</sup></b> Metal lever, plastic roller	19	⊕ B	3SE5 000-0AA24
		<b>Twist levers, adjustable length, with grid hole</b> Metal lever, plastic roller	19	⊕ B
Metal lever, high-grade steel roller		19	⊕ B	3SE5 000-0AA61
Metal lever, rubber roller		50	⊕ B	3SE5 000-0AA68
High-grade steel lever, plastic roller		19	⊕ B	3SE5 000-0AA62
High-grade steel lever, high-grade steel roller		19	⊕ B	3SE5 000-0AA63
		<b>Fork levers (for switches with snap-action contacts only)</b> 2 metal levers, 2 plastic rollers	19	⊕ B
	2 metal levers, 2 high-grade steel rollers	19	⊕ B	3SE5 000-0AT02
	2 high-grade steel levers, 2 plastic rollers	19	⊕ B	3SE5 000-0AT03

⊕ Positively driven actuator, necessary in safety circuits.

<sup>1)</sup> Can be clinch mounted (turned through 180°, rear of lever).

# 3SE5, 3SE2 position switches

## 3SE5, metal enclosures Enclosure width 56 mm

### Selection and ordering data

#### Complete units

2 or 3 contacts · Degree of protection IP66 / IP67 · Cable entry 3 × (M20 × 1.5)

Version	Contacts	LEDs	DT	Complete units
				Order No. <input type="checkbox"/>

#### Complete units<sup>1)</sup> · Enclosure width 56 mm



Plain plunger

##### Plain plungers

###### With high-grade steel plunger

Slow-action contacts	1 NO + 1 NC --	⊕ B	B	<b>3SE5 122-0BB01</b>
Snap-action contacts	1 NO + 1 NC --	⊕ B	B	<b>3SE5 122-0CB01</b>
Slow-action contacts	1 NO + 2 NC --	⊕ B	B	<b>3SE5 122-0KB01</b>
Snap-action contacts	1 NO + 2 NC --	⊕ B	B	<b>3SE5 122-0LB01</b>



Rounded plunger

##### Rounded plungers

###### With high-grade steel plungers, with 3 mm overtravel

Slow-action contacts	1 NO + 1 NC --	⊕ B	B	<b>3SE5 122-0BC02</b>
Snap-action contacts	1 NO + 1 NC --	⊕ ▶	B	<b>3SE5 122-0CC02</b>
Slow-action contacts	1 NO + 2 NC --	⊕ B	B	<b>3SE5 122-0KC02</b>
Snap-action contacts	1 NO + 2 NC --	⊕ B	B	<b>3SE5 122-0LC02</b>



Roller plunger

##### Roller plungers

###### With high-grade steel roller 13 mm, with 3 mm overtravel

Slow-action contacts	1 NO + 1 NC --	⊕ B	B	<b>3SE5 122-0BD02</b>
Snap-action contacts	1 NO + 1 NC --	⊕ A	A	<b>3SE5 122-0CD02</b>
Slow-action contacts	1 NO + 2 NC --	⊕ B	B	<b>3SE5 122-0KD02</b>
Snap-action contacts	1 NO + 2 NC --	⊕ B	B	<b>3SE5 122-0LD02</b>



Roller lever

##### Roller levers

###### With metal lever and plastic roller 22 mm

Slow-action contacts	1 NO + 1 NC --	⊕ B	B	<b>3SE5 122-0BE01</b>
Snap-action contacts	1 NO + 1 NC --	⊕ A	A	<b>3SE5 122-0CE01</b>
Slow-action contacts	1 NO + 2 NC --	⊕ B	B	<b>3SE5 122-0KE01</b>
Snap-action contacts	1 NO + 2 NC --	⊕ B	B	<b>3SE5 122-0LE01</b>

###### With metal lever and high-grade steel roller 22 mm

Snap-action contacts	1 NO + 1 NC --	⊕ B	B	<b>3SE5 122-0CE02</b>
----------------------	----------------	-----	---	-----------------------



Angular roller lever

##### Angular roller levers

###### With metal lever and plastic roller 22 mm

Slow-action contacts	1 NO + 1 NC --	⊕ B	B	<b>3SE5 122-0BF01</b>
Snap-action contacts	1 NO + 1 NC --	⊕ B	B	<b>3SE5 122-0CF01</b>

⊕ Positive opening according to IEC 60947-5-1, Appendix K.

<sup>1)</sup> Popular versions.

2 or 3 contacts · Degree of protection IP66 / IP67 · Cable entry 3 × (M20 × 1.5)

Version	Contacts	LEDs	DT	Complete units
				<input type="checkbox"/>
				Order No.

Complete units<sup>1)</sup> · Enclosure width 56 mm

Twist lever

**Twist levers****With metal lever 27 mm and plastic roller 19 mm**

Slow-action contacts	1 NO + 1 NC --	⊕ B	3SE5 122-0BH01
Snap-action contacts	1 NO + 1 NC --	⊕ A	3SE5 122-0CH01
Slow-action contacts	1 NO + 2 NC --	⊕ B	3SE5 122-0KH01
Snap-action contacts	1 NO + 2 NC --	⊕ B	3SE5 122-0LH01

**With metal lever 27 mm and high-grade steel roller 19 mm**

Snap-action contacts	1 NO + 1 NC --	⊕ B	3SE5 122-0CH02
Snap-action contacts	1 NO + 2 NC --	⊕ B	3SE5 122-0LH02

**Twist levers, adjustable length****With metal lever with grid hole and plastic roller 19 mm**

Slow-action contacts	1 NO + 1 NC --	⊕ B	3SE5 122-0BH60
Snap-action contacts	1 NO + 1 NC --	⊕ A	3SE5 122-0CH60
Snap-action contacts	1 NO + 2 NC --	⊕ B	3SE5 122-0LH60

Twist lever,  
adjustable  
length**Fork levers, latching****With metal lever and 2 plastic rollers 19 mm**

Snap-action contacts	1 NO + 1 NC --	⊕ B	3SE5 122-0CT11
----------------------	----------------	-----	----------------



Fork lever

⊕ Positive opening according to IEC 60947-5-1, Appendix K.

<sup>1)</sup> Popular versions.*Note: If the device you require is not available as a complete unit, see "Modular system" on the next page.*

# 3SE5, 3SE2 position switches

## 3SE5, metal enclosures Enclosure width 56 mm

### Modular system

2 or 3 contacts · Degree of protection IP66 / IP67 · Cable entry 3 × (M20 × 1.5)

Version	Contacts	LEDs	DT	Modular system
				Order No.

### Basic switches • Enclosure width 56 mm



Basic switch

#### With 3 x M20 x 1.5 connecting thread

Slow-action contacts	1 NO + 1 NC --	⊕ A	<b>3SE5 122-0BA00</b>
Snap-action contacts	1 NO + 1 NC --	⊕ A	<b>3SE5 122-0CA00</b>
Slow-action contacts	1 NO + 2 NC --	⊕ B	<b>3SE5 122-0KA00</b>
Snap-action contacts	1 NO + 2 NC --	⊕ A	<b>3SE5 122-0LA00</b>
Slow-action contacts with make-before-break	1 NO + 2 NC --	⊕ A	<b>3SE5 122-0MA00</b>
Slow-action contacts	2 NO + 1 NC --	⊕ A	<b>3SE5 122-0PA00</b>



With increased corrosion protection

#### With increased corrosion protection<sup>1)</sup>

Slow-action contacts	1 NO + 1 NC --	⊕ B	<b>3SE5 122-0BA00-1CA0</b>
Snap-action contacts	1 NO + 1 NC --	⊕ B	<b>3SE5 122-0CA00-1CA0</b>
Slow-action contacts	1 NO + 2 NC --	⊕ B	<b>3SE5 122-0KA00-1CA0</b>
Snap-action contacts	1 NO + 2 NC --	⊕ B	<b>3SE5 122-0LA00-1CA0</b>
Slow-action contacts with make-before-break	1 NO + 2 NC --	⊕ B	<b>3SE5 122-0MA00-1CA0</b>
Slow-action contacts	2 NO + 1 NC --	⊕ B	<b>3SE5 122-0PA00-1CA0</b>



With 2 LEDs

#### With 2 LEDs, yellow/green

Slow-action contacts	1 NO + 2 NC	24 V DC	⊕ B	<b>3SE5 122-1KA00</b>
Snap-action contacts	1 NO + 2 NC	24 V DC	⊕ B	<b>3SE5 122-1LA00</b>
Slow-action contacts	1 NO + 2 NC	230 V AC	⊕ B	<b>3SE5 122-3KA00</b>
Snap-action contacts	1 NO + 2 NC	230 V AC	⊕ B	<b>3SE5 122-3LA00</b>

⊕ Positive opening according to IEC 60947-5-1, Appendix K, or positively driven actuator, necessary in safety circuits.

<sup>1)</sup> Use corresponding high-grade steel lever.

*Note: For selection assistance, see page 2/8.*

Version	Diameter	DT	Modular system
			Order No.

### Operating mechanisms



Rounded plunger, roller plunger

#### Plain plungers

High-grade steel plungers	10	⊕ A	<b>3SE5 000-0AB01</b>
---------------------------	----	-----	-----------------------

#### Rounded plungers, type B acc. to EN 50041

High-grade steel plungers, with 3 mm overtravel	10	⊕ B	<b>3SE5 000-0AC02</b>
---	----	-----	-----------------------

#### Roller plungers, type C acc. to EN 50041

High-grade steel roller, with 3 mm overtravel	13	⊕ B	<b>3SE5 000-0AD02</b>
---	----	-----	-----------------------



Roller lever

#### Roller levers

Metal lever, plastic roller	22	⊕ A	<b>3SE5 000-0AE01</b>
Metal lever, high-grade steel roller	22	⊕ B	<b>3SE5 000-0AE02</b>
High-grade steel lever, plastic roller	22	⊕ B	<b>3SE5 000-0AE03</b>
High-grade steel lever, high-grade steel roller	22	⊕ B	<b>3SE5 000-0AE04</b>



Angular roller lever

#### Angular roller levers

Metal lever, plastic roller	22	⊕ A	<b>3SE5 000-0AF01</b>
Metal lever, high-grade steel roller	22	⊕ B	<b>3SE5 000-0AF02</b>
High-grade steel lever, plastic roller	22	⊕ B	<b>3SE5 000-0AF03</b>
High-grade steel lever, high-grade steel roller	22	⊕ B	<b>3SE5 000-0AF04</b>

⊕ Positively driven actuator, necessary in safety circuits.

Version	Diameter	DT	Modular system
	mm		Order No.

## Twist actuators



Twist actuator

**Twist actuators**, metal (without lever)

- For twist levers and rod actuators, switching right and/or left, adjustable
- For fork levers, latching

⊕ A

3SE5 000-0AH00

⊕ B

3SE5 000-0AT10

**Levers for twist actuators****Twist levers 27 mm, offset, type A acc. to EN 50041**

Metal lever, plastic roller

19

⊕ A

3SE5 000-0AA01

Metal lever, high-grade steel roller

19

⊕ A

3SE5 000-0AA02

Metal lever, roller with ball bearing

19

⊕ B

3SE5 000-0AA03

Metal lever, 2 plastic rollers

19

⊕ B

3SE5 000-0AA04

Metal lever, plastic roller

30

⊕ B

3SE5 000-0AA05

Metal lever, plastic roller

50

⊕ B

3SE5 000-0AA07

Metal lever, rubber roller

50

⊕ B

3SE5 000-0AA08

High-grade steel lever, plastic roller

19

⊕ B

3SE5 000-0AA11

High-grade steel lever, high-grade steel roller

19

⊕ B

3SE5 000-0AA12

**Twist levers 35 mm, offset**

Metal lever, plastic roller

19

⊕ B

3SE5 000-0AA15

**Twist levers 30 mm, straight<sup>1)</sup>**

Metal lever, plastic roller

19

⊕ B

3SE5 000-0AA24

Metal lever, rubber roller

30

⊕ B

3SE5 000-0AA26

**Twist levers, adjustable length, with grid hole**

Metal lever, plastic roller

19

⊕ B

3SE5 000-0AA60

Metal lever, high-grade steel roller

19

⊕ B

3SE5 000-0AA61

Metal lever, plastic roller

50

⊕ B

3SE5 000-0AA67

Metal lever, rubber roller

50

⊕ B

3SE5 000-0AA68

High-grade steel lever, plastic roller

19

⊕ B

3SE5 000-0AA62

High-grade steel lever, high-grade steel roller

19

⊕ B

3SE5 000-0AA63



Twist lever, adjustable length

**Fork levers** (for switches with snap-action contacts only)

2 metal levers, 2 plastic rollers

19

⊕ B

3SE5 000-0AT01

2 metal levers, 2 high-grade steel rollers

19

⊕ B

3SE5 000-0AT02

2 high-grade steel levers, 2 plastic rollers

19

⊕ B

3SE5 000-0AT03

2 high-grade steel levers, 2 high-grade steel rollers

19

⊕ B

3SE5 000-0AT04



Fork lever

⊕ Positively driven actuator, necessary in safety circuits.

<sup>1)</sup> Can be clinch mounted (turned through 180°, rear of lever).

# 3SE5, 3SE2 position switches

**Metal enclosures**  
Enclosure width 56 mm, XL

## Selection and ordering data

### Complete units

4 or 5 contacts · Degree of protection IP66 / IP67 · Cable entry 3 × (M20 × 1.5)

Version	Contacts	LEDs	DT	Complete units
				<input type="checkbox"/>
				Order No.

### Complete units<sup>1)</sup> • Enclosure width 56 mm, XL



Plain plunger

#### Plain plungers

##### With high-grade steel plunger

Snap-action contacts      2 × (1 NO + 1 NC) --      ⊕ B      **3SE5 162-0CB01**



Rounded plunger

#### Rounded plungers

##### With high-grade steel plungers, with 3 mm overtravel

Slow-action contacts      1 NO + 1 NC and --      ⊕ B      **3SE5 162-0EC02**  
Slow-action contacts with  
make-before-break      1 NO + 2 NC  
2 mm travel difference



Roller plunger

#### Roller plungers

##### With high-grade steel roller 13 mm, with 3 mm overtravel

Slow-action contacts      2 × (1 NO + 1 NC) --      ⊕ B      **3SE5 162-0BD02**  
Snap-action contacts      2 × (1 NO + 1 NC) --      ⊕ A      **3SE5 162-0CD02**



Roller lever

#### Roller levers

##### With metal lever and plastic roller 22 mm

Slow-action contacts      2 × (1 NO + 1 NC) --      ⊕ B      **3SE5 162-0BE01**  
Snap-action contacts      2 × (1 NO + 1 NC) --      ⊕ A      **3SE5 162-0CE01**

##### With metal lever and high-grade steel roller 22 mm

Snap-action contacts      2 × (1 NO + 1 NC) --      ⊕ B      **3SE5 162-0CE02**



Angular roller lever

#### Angular roller levers

##### With metal lever and plastic roller 22 mm

Snap-action contacts      2 × (1 NO + 1 NC) --      ⊕ B      **3SE5 162-0CF01**



Twist lever

#### Twist levers

##### With metal lever 27 mm and plastic roller 19 mm

Snap-action contacts      2 × (1 NO + 1 NC) --      ⊕ A      **3SE5 162-0CH01**

⊕ Positive opening according to IEC 60947-5-1, Appendix K.

<sup>1)</sup> Popular versions.

*Note: If the device you require is not available as a complete unit, see "Modular system" on the next page.*



**Modular system**

4 or 6 contacts · Degree of protection IP66 / IP67 · Cable entry 3 × (M20 × 1.5)

Version	Contacts	LEDs	DT	Modular system
				Order No. 

**Basic switches · Enclosure width 56 mm, XL**

Basic switch

**With 3 x M20 x 1.5 connecting thread**

Slow-action contacts	2 × (1 NO + 1 NC) --	⊕ A	<b>3SE5 162-0BA00</b>
Snap-action contacts	2 × (1 NO + 1 NC) --	⊕ A	<b>3SE5 162-0CA00</b>
Slow-action contacts with make-before-break	2 × (1 NO + 2 NC) --	⊕ A	<b>3SE5 162-0DA00</b>

**With increased corrosion protection<sup>1)</sup>**

Slow-action contacts	2 × (1 NO + 1 NC) --	⊕ B	<b>3SE5 162-0BA00-1CA0</b>
Snap-action contacts	2 × (1 NO + 1 NC) --	⊕ B	<b>3SE5 162-0CA00-1CA0</b>
Slow-action contacts with make-before-break	2 × (1 NO + 2 NC) --	⊕ B	<b>3SE5 162-0DA00-1CA0</b>

⊕ Positive opening according to IEC 60947-5-1, Appendix K, or positively driven actuator, necessary in safety circuits.

1) Use corresponding high-grade steel lever.

*Note: For selection assistance, see page 2/8.*

Version	Diameter	DT	Modular system
			Order No. 
		mm	

**Operating mechanisms**

Plain plunger

**Plain plungers**

High-grade steel plungers	10	⊕ A	<b>3SE5 000-0AB01</b>
---------------------------	----	-----	-----------------------



Rounded plunger

**Rounded plungers, type B acc. to EN 50041**

High-grade steel plungers, with 3 mm overtravel	10	⊕ B	<b>3SE5 000-0AC02</b>
---	----	-----	-----------------------



Roller plunger

**Roller plungers, type C acc. to EN 50041**

High-grade steel roller, with 3 mm overtravel	13	⊕ B	<b>3SE5 000-0AD02</b>
---	----	-----	-----------------------



Roller lever

**Roller levers**

Metal lever, plastic roller	22	⊕ A	<b>3SE5 000-0AE01</b>
Metal lever, high-grade steel roller	22	⊕ B	<b>3SE5 000-0AE02</b>
High-grade steel lever, plastic roller	22	⊕ B	<b>3SE5 000-0AE03</b>
High-grade steel lever, high-grade steel roller	22	⊕ B	<b>3SE5 000-0AE04</b>



Angular roller lever





**Angular roller levers**

Metal lever, plastic roller	22	⊕ A	<b>3SE5 000-0AF01</b>
Metal lever, high-grade steel roller	22	⊕ B	<b>3SE5 000-0AF02</b>
High-grade steel lever, plastic roller	22	⊕ B	<b>3SE5 000-0AF03</b>
High-grade steel lever, high-grade steel roller	22	⊕ B	<b>3SE5 000-0AF04</b>

⊕ Positively driven actuator, necessary in safety circuits.

# 3SE5, 3SE2 position switches

## Metal enclosures Enclosure width 56 mm, XL

Version	Diameter	DT	Modular system	
	mm		Order No.	
<b>Twist actuators</b>				
	<b>Twist actuators, metal (without lever)</b>			
	<ul style="list-style-type: none"> <li>For twist levers and rod actuators, switching right and/or left, adjustable</li> <li>For fork levers, latching</li> </ul>	<ul style="list-style-type: none"> <li>⊕ A</li> <li>⊕ B</li> </ul>	<ul style="list-style-type: none"> <li><b>3SE5 000-0AH00</b></li> <li><b>3SE5 000-0AT10</b></li> </ul>	
<b>Levers for twist actuators</b>				
	<b>Twist levers 27 mm, offset, type A acc. to EN 50041</b>			
	Metal lever, plastic roller	19	⊕ A	<b>3SE5 000-0AA01</b>
	Metal lever, high-grade steel roller	19	⊕ A	<b>3SE5 000-0AA02</b>
	Metal lever, roller with ball bearing	19	⊕ B	<b>3SE5 000-0AA03</b>
	Metal lever, 2 plastic rollers	19	⊕ B	<b>3SE5 000-0AA04</b>
	Metal lever, plastic roller	30	⊕ B	<b>3SE5 000-0AA05</b>
	Metal lever, plastic roller	50	⊕ B	<b>3SE5 000-0AA07</b>
	Metal lever, rubber roller	50	⊕ B	<b>3SE5 000-0AA08</b>
	High-grade steel lever, plastic roller	19	⊕ B	<b>3SE5 000-0AA11</b>
	High-grade steel lever, high-grade steel roller	19	⊕ B	<b>3SE5 000-0AA12</b>
	<b>Twist levers 35 mm, offset</b>			
	Metal lever, plastic roller	19	⊕ B	<b>3SE5 000-0AA15</b>
<b>Twist levers 30 mm, straight<sup>1)</sup></b>				
Metal lever, plastic roller	19	⊕ B	<b>3SE5 000-0AA24</b>	
Metal lever, plastic roller	30	⊕ B	<b>3SE5 000-0AA26</b>	
	<b>Twist levers, adjustable length, with grid hole</b>			
	Metal lever, plastic roller	19	⊕ B	<b>3SE5 000-0AA60</b>
	Metal lever, high-grade steel roller	19	⊕ B	<b>3SE5 000-0AA61</b>
	Metal lever, plastic roller	50	⊕ B	<b>3SE5 000-0AA67</b>
	Metal lever, rubber roller	50	⊕ B	<b>3SE5 000-0AA68</b>
	High-grade steel lever, plastic roller	19	⊕ B	<b>3SE5 000-0AA62</b>
High-grade steel lever, high-grade steel roller	19	⊕ B	<b>3SE5 000-0AA63</b>	
	<b>Fork levers (for switches with snap-action contacts only)</b>			
	2 metal levers, 2 plastic rollers	19	⊕ B	<b>3SE5 000-0AT01</b>
	2 metal levers, 2 high-grade steel rollers	19	⊕ B	<b>3SE5 000-0AT02</b>
	2 high-grade steel levers, 2 plastic rollers	19	⊕ B	<b>3SE5 000-0AT03</b>
	2 high-grade steel levers, 2 high-grade steel rollers	19	⊕ B	<b>3SE5 000-0AT04</b>

⊕ Positively driven actuator, necessary in safety circuits.

<sup>1)</sup> Can be clinch mounted (turned through 180°, rear of lever).

3SE5, metal enclosures  
Ambient temperature up to -40 °C

## Selection and ordering data

## Complete units

2 or 3 contacts · Degree of protection IP66 / IP67 · Cable entry M20 × 1.5

Version	Contacts	LEDs	DT	Complete units
				<input type="checkbox"/>
				Order No.

## Complete units • Enclosure width 40 mm

Twist lever,  
adjustable  
length

## Twist levers, adjustable length

With high-grade steel lever with grid hole  
and plastic roller 19 mmSnap-action contacts      1 NO + 1 NC --      ⤴ A      **3SE5 112-0CH62-1AJ0**

## Modular system

2 or 3 contacts · Degree of protection IP66 / IP67 · Cable entry M20 × 1.5

Version	Contacts	LEDs	DT	Modular system
				<input type="checkbox"/>
				Order No.

## Basic switches • Enclosure width 40 mm



Basic switch

## With M20 × 1.5 connecting thread

Snap-action contacts	1 NO + 1 NC --	⤴ B	<b>3SE5 112-0CA00-1AJ0</b>
Slow-action contacts	1 NO + 2 NC --	⤴ B	<b>3SE5 112-0KA00-1AJ0</b>
Snap-action contacts	1 NO + 2 NC --	⤴ B	<b>3SE5 112-0LA00-1AJ0</b>

## Basic switches • Enclosure width 56 mm



Basic switch

## With 3 x M20 × 1.5 connecting thread







Snap-action contacts	1 NO + 1 NC --	⤴ B	<b>3SE5 122-0CA00-1AJ0</b>
Slow-action contacts	1 NO + 2 NC --	⤴ B	<b>3SE5 122-0KA00-1AJ0</b>
Snap-action contacts	1 NO + 2 NC --	⤴ B	<b>3SE5 122-0LA00-1AJ0</b>

⤴ Positive opening according to IEC 60947-5-1, Appendix K or positively driven actuator, necessary in safety circuits.

*Note: For selection assistance, see page 2/8.*

# 3SE5, 3SE2 position switches

3SE5, metal enclosures  
Ambient temperature up to -40 °C

Version	Diameter	DT	Modular system
	mm		Order No.
<b>Operating mechanisms</b>			
 Rounded plunger	<b>Rounded plungers, type B acc. to EN 50041</b> High-grade steel plungers, with 3 mm overtravel	10	☞ B <b>3SE5 000-0AC02-1AJ0</b>
 Roller plunger	<b>Roller plungers, type C acc. to EN 50041</b> High-grade steel roller, with 3 mm overtravel	10	☞ B <b>3SE5 000-0AD02-1AJ0</b>
 Roller lever	<b>Roller levers</b> Metal lever, plastic roller	13	☞ B <b>3SE5 000-0AE01-1AJ0</b>
	High-grade steel lever, plastic roller	13	☞ B <b>3SE5 000-0AE03-1AJ0</b>
 Angular roller lever	<b>Angular roller levers</b> Metal lever, plastic roller	13	☞ B <b>3SE5 000-0AF01-1AJ0</b>
	High-grade steel lever, plastic roller	13	☞ B <b>3SE5 000-0AF03-1AJ0</b>
<b>Twist actuators</b>			
 Twist actuator	<b>Twist actuators, metal (without lever)</b> Switching right and/or left, adjustable		☞ B <b>3SE5 000-0AH00-1AJ0</b>
<b>Levers for twist actuators</b>			
 Twist lever	<b>Twist levers, type A acc. to EN 50041</b> Metal lever, plastic roller	19	☞ B <b>3SE5 000-0AA01-1AJ0</b>
	High-grade steel lever, plastic roller	19	☞ B <b>3SE5 000-0AA11-1AJ0</b>
 Twist lever, adjustable length	<b>Twist levers, adjustable length, with grid hole</b> Metal lever, plastic roller	19	☞ B <b>3SE5 000-0AA60-1AJ0</b>
	High-grade steel lever, plastic roller	19	☞ B <b>3SE5 000-0AA62-1AJ0</b>

☞ Positively driven actuator, necessary in safety circuits.

## Overview

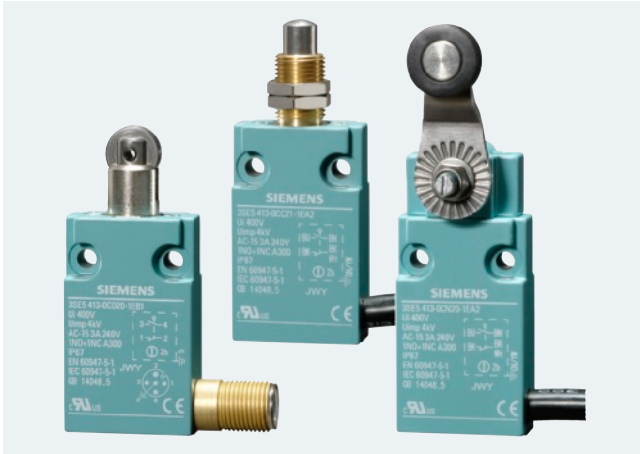

Compact design in width 30 mm

Particularly in harsh environments or on equipment with limited space, the small 3SE5 4 position switches in compact design with a depth of 16 mm and a weight of only 80 g (without cable) are ideal. Above all the versions with molded cable can be mounted in the most confined places.

3SE5 4 compact position switches are available in two different widths as complete units:

- The 3SE5 413 series complies with the EU standard and features a 30 mm wide enclosure with drilled holes at a distance of 20 mm.
- The 3SE5 423 series meets the requirements of the US market and features a 40 mm wide enclosure with drilled holes at a spacing of 25 mm.

Both the enclosure and the twist actuator are made of metal and comply with the high IP67 degree of protection. Following actuators are available:

- Rounded plungers
- Rounded plungers with central fixing
- Rounded plungers with external seal
- Roller plungers
- Roller plunger with central fixing
- Twist levers

The contact block is designed with snap-action contacts 1 NO + 1 NC. The NC contact complies with the requirements for positive opening acc. to IEC 60947-5-1.

Use in safety circuits up to Category 4 according to EN ISO 13849-1.

Connection:

- With molded cable, 2 m or 5 m long
- With M12 connector socket

## Benefits







- Very compact yet with the same rating as the 3SE51 standard switches, for notable space savings in confined installation conditions
- Various actuator versions available
- The actuators can be rotated in 90° increments
- Time is saved when mounting the fully assembled unit
- Ideal for use in harsh industrial environments thanks to metal enclosure with degrees of protection IP67
- Insensitive to electromagnetic interference

# 3SE5, 3SE2 position switches

## 3SE5, metal enclosures Compact design

### Selection and ordering data

2 snap-action contacts 1 NO + 1 NC · Degree of protection IP67 · With connecting cable or M12 connector socket

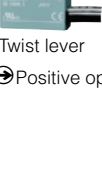
Operating mechanism		Enclosure width mm	DT	Order No.
<b>Complete units • Enclosure width 30 or 40 mm</b>				
<b>Rounded plungers</b>				
	• Standard mounting			
	- With 2 m cable 5 x 0.75 mm <sup>2</sup>	30	⊕ A	<b>3SE5 413-0CC20-1EA2</b>
		40	⊕ A	<b>3SE5 423-0CC20-1EA2</b>
Rounded plunger	- With 5 m cable 5 x 0.75 mm <sup>2</sup>	30	⊕ B	<b>3SE5 413-0CC20-1EA5</b>
	- With M12 connector socket	30	⊕ A	<b>3SE5 413-0CC20-1EB1</b>
		40	⊕ A	<b>3SE5 423-0CC20-1EB1</b>
	• With M12 central fixing			
	- With 2 m cable 5 x 0.75 mm <sup>2</sup>	30	⊕ A	<b>3SE5 413-0CC21-1EA2</b>
		40	⊕ A	<b>3SE5 423-0CC21-1EA2</b>
With central fixing				
	• With external seal			
	- With 2 m cable 5 x 0.75 mm <sup>2</sup>	30	⊕ A	<b>3SE5 413-0CC22-1EA2</b>
		40	⊕ A	<b>3SE5 423-0CC22-1EA2</b>
With external seal				
<b>Roller plungers</b>				
	• Standard mounting			
	- With 2 m cable 5 x 0.75 mm <sup>2</sup>	30	⊕ A	<b>3SE5 413-0CD20-1EA2</b>
		40	⊕ A	<b>3SE5 423-0CD20-1EA2</b>
Roller plunger	- With 5 m cable 5 x 0.75 mm <sup>2</sup>	30	⊕ B	<b>3SE5 413-0CD20-1EA5</b>
	- With M12 connector socket	30	⊕ A	<b>3SE5 413-0CD20-1EB1</b>
		40	⊕ A	<b>3SE5 423-0CD20-1EB1</b>
	• With M12 central fixing			
	- With 2 m cable 5 x 0.75 mm <sup>2</sup>	30	⊕ A	<b>3SE5 413-0CD21-1EA2</b>
		40	⊕ A	<b>3SE5 423-0CD21-1EA2</b>
With plug				
	• Actuator head rotated 90°			
	- With 2 m cable 5 x 0.75 mm <sup>2</sup>	30	⊕ A	<b>3SE5 413-0CD23-1EA2</b>
<b>Twist levers</b>				
	• Standard mounting			
	- With 2 m cable 5 x 0.75 mm <sup>2</sup>	30	⊕ A	<b>3SE5 413-0CN20-1EA2</b>
		40	⊕ A	<b>3SE5 423-0CN20-1EA2</b>
Twist lever	- With 5 m cable 5 x 0.75 mm <sup>2</sup>	30	⊕ A	<b>3SE5 413-0CN20-1EA5</b>
	- With M12 connector socket	30	⊕ A	<b>3SE5 413-0CN20-1EB1</b>
		40	⊕ A	<b>3SE5 423-0CN20-1EB1</b>

⊕ Positive opening according to IEC 60947-5-1, Appendix K.

## Overview



Open-type

Their compact design makes these switches particularly suitable for use in confined conditions. The fixing dimensions and operating points are according to EN 50047.



The switches are equipped with two or three contacts in slow-action or snap-action versions. The stroke is 6 mm.

The empty enclosure can be equipped with all switch block variants (see page 2/43).

2

## Selection and ordering data

2 or 3 contacts · Degree of protection IP20 (2 contacts), IP10 (3 contacts)

Version	Contacts	DT	Order No.
<b>Molded-plastic enclosures • Enclosure width 30 mm</b>			
<b>With teflon plunger, Ø 6 mm</b>			
With contact block with 2 contacts			
 2 contacts	Slow-action contacts	1 NO + 1 NC	⊙ A <b>3SE5 250-0BC05</b>
	Snap-action contacts	1 NO + 1 NC	⊙ ▶ <b>3SE5 250-0CC05</b>
With contact block with 3 contacts			
 3 contacts	Slow-action contacts	1 NO + 2 NC	⊙ B <b>3SE5 250-0KC05</b>
	Snap-action contacts	1 NO + 2 NC	⊙ A <b>3SE5 250-0LC05</b>
	Slow-action contacts with make-before-break	1 NO + 2 NC	⊙ A <b>3SE5 250-0MC05</b>
	Slow-action contacts	2 NO + 1 NC	⊙ A <b>3SE5 250-0PC05</b>
 Empty enclosure	Empty enclosures without contact block	--	⊙ B <b>3SE5 250-0AC05</b>















⊙ Positive opening according to IEC 60947-5-1, Appendix K.

# 3SE5, 3SE2 position switches

## Accessories and spare parts

### Selection and ordering data

The quick-release devices and plug-in connections are used for fast installation and replacement of position switches.

Version	DT	Order No.
<b>Quick-release devices for enclosure width 40 mm</b>		
	<b>Adapter plates with screws</b>	B <b>3SY3 110</b>
	<b>Base plates with locking lever</b>	B <b>3SY3 027</b>
		
3SY3 110	3SY3 027	
<b>Plug-in connections for M20 × 1.5 connecting threads</b>		
	<b>Connector sockets (6-pole + PE), for M20 × 1.5</b> For max. 250 V, 10 A With 0.75 mm <sup>2</sup> connecting cable, plastic, degree of protection IP65, ambient temperature -40 to +90 °C	C <b>3SY3 131</b>
	<b>Cable boxes (6-pole + PE)<sup>1)</sup></b> With terminal compartment, can be pre-assembled, plastic, degree of protection IP65	A <b>3SY3 136</b>
3SY3 131	3SY3 136	
	<b>Connector sockets (4-pole), M12, for M20 × 1.5, fixed</b> For max 250 V, 4 A, $U_{imp} = 2500$ V With four 0.25 mm <sup>2</sup> connecting cables, plastic, degree of protection IP67, ambient temperature -40 to +85 °C	B <b>3SY3 127</b>
	<b>Connector sockets (5-pole), M12, for M20 × 1.5, fixed</b> For max. 125 V, 4 A, $U_{imp} = 1500$ V With five 0.25 mm <sup>2</sup> connecting cables, plastic, degree of protection IP67, ambient temperature -40 to +85 °C	B <b>3SY3 128</b>
3SY3 127	3SY3 134	
	<b>Connector sockets (8-pole), M12, for M20 × 1.5, fixed, metal version</b> For max. 30 V, 2 A, $U_{imp} = 800$ V With eight 0.25 mm <sup>2</sup> connecting cables, metal, degree of protection IP67, ambient temperature -40 to +85 °C	C <b>3SY3 134</b>
<b>Adapters and cable glands for M20 × 1.5 connecting threads</b>		
	<b>Adapters according to ,  and </b> For cable entry from M20 × 1.5 to NPT 1/2	B <b>3SX9 917</b>
	<ul style="list-style-type: none"> <li>• Metal</li> <li>• Plastic</li> </ul>	D <b>3SX9 918</b>
3SX9 917	3SX9 918	
	<b>Cable glands M20 × 1.5</b> Plastic	A <b>3SX9 926</b>
3SX9 926		

<sup>1)</sup> For wiring, a crimping tool is necessary, max. conductor cross-section 1 mm<sup>2</sup>.



Version	Color/ contacts	DT	Order No.
---------	--------------------	----	-----------

## Optional accessories for 3SE52



**Protective caps, rubber,**  
for rounded plungers acc. to EN 50047,  
3SE5 ...-...C05

Black

A

3SE5 000-0AC30

## Spare parts for 3SE51, 3SE52

**Empty enclosures, plastic**

Turquoise

Enclosure width 31 mm

B

3SE5 232-0AC05

- With increased corrosion protection

B

3SE5 232-0AC05-1CA0

Enclosure width 50 mm

B

3SE5 242-0AC05

- With increased corrosion protection

B

3SE5 242-0AC05-1CA0

Enclosure width 31 mm

**Empty enclosures, metal**

Turquoise

Enclosure width 31 mm

B

3SE5 212-0AC05

- With increased corrosion protection

B

3SE5 212-0AC05-1CA0

Enclosure width 40 mm

B

3SE5 112-0AA00

- With increased corrosion protection

B

3SE5 112-0AA00-1CA0

Enclosure width 56 mm

B

3SE5 122-0AA00

- With increased corrosion protection

B

3SE5 122-0AA00-1CA0

Enclosure width 56 mm, XL<sup>1)</sup>

B

3SE5 162-0AA00

Enclosure width 40 mm

**Contact blocks with 2 contacts**

- Slow-action contacts

1 NO + 1 NC



B

3SE5 000-0BA00

- Snap-action contacts

1 NO + 1 NC



B

3SE5 000-0CA00

- Standard



B

3SE5 000-0CA00

- Gold-plated contacts



B

3SE5 000-0CA00-1AC1

- 2 × 2 mm switching interval



B

3SE5 000-0GA00

- Short stroke



B

3SE5 000-0NA00

2 contacts

**Contact blocks with 3 contacts**

- Slow-action contacts

1 NO + 2 NC



B

3SE5 000-0KA00

- Snap-action contacts

1 NO + 2 NC



B

3SE5 000-0LA00

- Slow-action contacts with  
make-before-break

1 NO + 2 NC



A

3SE5 000-0MA00

- Slow-action contacts

2 NO + 1 NC



A

3SE5 000-0PA00

3 contacts

⊕ Positive opening according to IEC 60947-5-1, Appendix K.

<sup>1)</sup> Equip XL enclosures with contact combinations shown on pages 2/34 and 2/35.

# 3SE5, 3SE2 position switches

## Accessories and spare parts

Version	Rated voltage LED V	DT	Order No.
---------	---------------------------	----	-----------

### Spare parts for 3SE51, 3SE52



31 mm, turquoise  
with LED

#### Covers for molded-plastic enclosures, width 31 mm

• Turquoise with LED	24 DC	B	<b>3SE5 230-1AA00</b>
	230 AC	B	<b>3SE5 230-3AA00</b>
• Yellow	--	B	<b>3SE5 230-0AA00-1AG0</b>
• Yellow with LED	24 DC	B	<b>3SE5 230-1AA00-1AG0</b>
	230 AC	B	<b>3SE5 230-3AA00-1AG0</b>



40 mm, yellow with LED

#### Covers for molded-plastic enclosures, width 40 mm

• Turquoise with LED	24 DC	B	<b>3SE5 130-1AA00</b>
	230 AC	B	<b>3SE5 130-3AA00</b>
• Yellow	--	B	<b>3SE5 130-0AA00-1AG0</b>
• Yellow with LED	24 DC	B	<b>3SE5 130-1AA00-1AG0</b>
	230 AC	B	<b>3SE5 130-3AA00-1AG0</b>



50 mm, turquoise  
with LED

#### Covers for molded-plastic enclosures, width 50 mm

• Turquoise with LED	24 DC	B	<b>3SE5 240-1AA00</b>
	230 AC	B	<b>3SE5 240-3AA00</b>
• Yellow	--	B	<b>3SE5 240-0AA00-1AG0</b>
• Yellow with LED	24 DC	B	<b>3SE5 240-1AA00-1AG0</b>
	230 AC	B	<b>3SE5 240-3AA00-1AG0</b>



31 mm, turquoise  
with LED

#### Covers for metal enclosures, width 31 mm

• Turquoise with LED	24 DC	B	<b>3SE5 210-1AA00</b>
	230 AC	B	<b>3SE5 210-3AA00</b>
• Yellow	--	B	<b>3SE5 210-0AA00-1AG0</b>
• Yellow with LED	24 DC	B	<b>3SE5 210-1AA00-1AG0</b>
	230 AC	B	<b>3SE5 210-3AA00-1AG0</b>



40 mm, yellow with LED

#### Covers for metal enclosures, width 40 mm

• Turquoise with LED	24 DC	B	<b>3SE5 110-1AA00</b>
	230 AC	B	<b>3SE5 110-3AA00</b>
• Yellow	--	B	<b>3SE5 110-0AA00-1AG0</b>
• Yellow with LED	24 DC	B	<b>3SE5 110-1AA00-1AG0</b>
	230 AC	B	<b>3SE5 110-3AA00-1AG0</b>



56 mm, yellow with LED

#### Covers for metal enclosures, width 56 mm

• Turquoise with LED	24 DC	B	<b>3SE5 120-1AA00</b>
	230 AC	B	<b>3SE5 120-3AA00</b>
• Yellow	--	B	<b>3SE5 120-0AA00-1AG0</b>
• Yellow with LED	24 DC	B	<b>3SE5 120-1AA00-1AG0</b>
	230 AC	B	<b>3SE5 120-3AA00-1AG0</b>

#### Covers for XL metal enclosures, width 56 mm

• Yellow	--	B	<b>3SE5 160-0AA00-1AG0</b>
----------	----	---	----------------------------

# 3SE5, 3SE2 position switches

## With separate actuator

General data

### Overview

Position switches with separate actuator are used where the position of doors, covers or protective grills must be monitored for safety reasons.

3SE5 position switches with separate actuator have the same enclosures as the standard switches (modular system).



Position switches with head for separate actuator

### Design

#### Enclosure sizes

The 3SE5 switches are available in various enclosure sizes:

- Molded-plastic enclosures according to EN 50047, 31 mm wide, IP65, 1 cable entry
- Metal enclosures according to EN 50047, 31 mm wide, IP66 / IP67, 1 cable entry
- Molded-plastic and metal enclosures according to EN 50041, 40 mm wide, IP66 / IP67, 1 cable entry
- Molded-plastic enclosures, 50 mm wide, IP66 / IP67, 2 cable entries
- Metal enclosures, 56 mm wide, IP66 / IP67, 3 cable entries

Also available is a switch in the 3SE2 series which has arisen in this form according to general market requirements:

- Molded-plastic enclosures outside of the standards, enclosure width 52 mm, IP67

#### Enclosure versions

Various basic versions can be selected for the enclosures of the 3SE5 series:

- Available with two- or three-pole switching elements designed as slow-action contacts
- Optional LED status display
- With mounted four- or five-pole M12 connector socket (available for the wide enclosures as an accessory for self-assembly)
- With 6-pole connector socket + PE on the metal enclosures
- Similarly with a combination of connector socket and LED indicators
- Metal enclosures for explosion protection (ATEX) (see pages 2/69 and 2/73)
- AS-Interface version with integrated ASIsafe electronics for all enclosure designs (see page 2/82)

For a description of the basic switches see page 2/4.

### Operation

The actuator head is included in the scope of supply. For actuation from four directions it can be adjusted through  $4 \times 90^\circ$ . The switches can also be approached from above.

The twist actuators of the 3SE2 243 and 3SE2 257 switches with special enclosures cannot be changed. The switches can be approached from the two broad sides and from above.

The actuators are not included in the scope of supply of the position switch and must be ordered separately from a choice of six versions to suit the application (see page 2/51).

The actuator is encoded. Simple overruling by hand or auxiliary devices is impossible.

#### Radius actuators

The position switches with radius actuators are particularly suitable for rotatable protective devices. The movable actuation key allows even small radii to be approached. Damage to the switch and the actuator due to inaccurate approach is prevented.

#### Locking devices

A high-grade steel blocking insert for attaching up to eight padlocks is available for even more safety (see page 2/51).

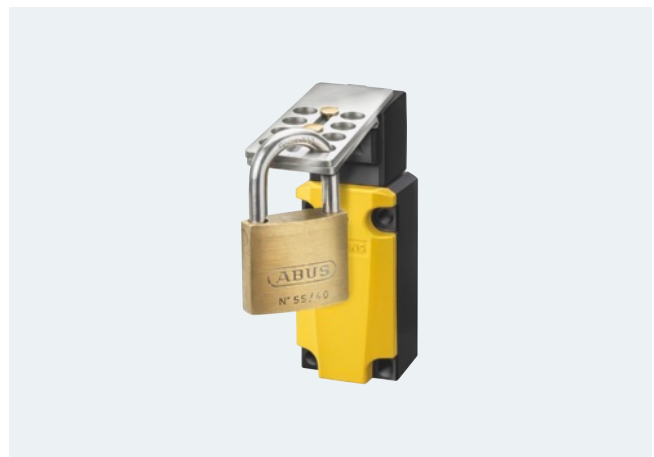

Blocking insert with padlock

#### Dust protection

A rubber cap to protect the twist actuator from contamination is available for operation in dusty environments (see page 2/51).

#### Contact reliability

The new switching blocks ensure an extremely high contact stability. This applies even when the devices are switching low voltages and currents, e.g. 1 mA at 5 V DC.

#### Positive opening

The NC contacts of the switch are forced open mechanically, positively-driven and reliably by the plunger. This is referred to as "positive opening".

2

# 3SE5, 3SE2 position switches

## With separate actuator

### General data

#### Benefits

The 3SE5 position switches with separate actuator differ from the previous series through the following new characteristics:

- All enclosure sizes with increased corrosion protection
- All enclosure sizes are optionally available with a LED signaling indicator.
- The three-pole contact block 1 NO + 2 NC is available for all enclosure sizes.
- The molded-plastic enclosure has simple and fast wiring equipment which makes it possible to save from approx. 20 to 25 % of the time when connecting.
- The ASIsafe electric component is integrated for the versions with the AS-Interface connection (see page 2/82); an adapter is not required.

#### Application

Position switches with separate actuator are used where the position of doors, covers or protective grills must be monitored for safety reasons.

The position switch can only be operated with the matching coded actuator. Simple overruling by hand or auxiliary devices is impossible.

Devices are available with enclosure versions to suit the particular ambient conditions. Different control tasks can be performed with the best contact blocks suited for the particular purpose. Dimensions, fixing points of the enclosure are in

accordance with EN 50041 or EN 50047 standards. The devices are suitable for use in any climate.

#### Standards

IEC 60947-5-1 or EN 60947-5-1.

The protective measure of "total insulation" by the molded-plastic enclosure is guaranteed by the use of molded-plastic screw-glands.

#### Safety position switches

For controls according to IEC 60204-1 or EN 60204-1 the devices can be used as a safety position switch. To secure position switches against changes in their position, keyed techniques must be employed on installation.

#### Safety circuits

IEC 60947-5-1 and EN 60947-5-1 require positive opening of the NC contacts, i.e. for the purposes of personal safety, the assured opening of NC contacts is expressly stipulated for the electrical equipment of machines in all safety circuits and marked according to the IEC standard 60947-5-1 with the symbol .

Category 3 according to ISO 13849-1 (EN 954-1) can be attained with a position switch with a separate actuator if the corresponding failsafe evaluation units are selected and correctly installed, e.g. the 3TK28 safety relays or matching units from the ASIsafe, SIMATIC or SINUMERIK product ranges.

Category 4 can be achieved when using an additional position switch.

### Technical specifications

Type		3SE5 1...-V.., 3SE5 2...-V..	3SE2 257-.XX..	3SE2 243-.XX..	
<b>General data</b>					
<b>Standards</b>		IEC 60947-5-1, EN 60947-5-1			
<b>Rated insulation voltage <math>U_i</math></b>	V	400	500		
<b>Pollution degree</b> acc. to EN 60664-1		Class 3	Class 3		
<b>Rated impulse withstand voltage <math>U_{imp}</math></b>	kV	6	6		
<b>Rated operational voltage <math>U_e</math></b>	V	400 AC; over 300 V AC only equal potential	500 AC; over 380 V AC only equal potential		
<b>Conventional thermal current <math>I_{th}</math></b>	A	6	10		
<b>Rated operational current <math>I_e</math></b>		2-pole	3-pole	1-pole	3-pole
• With alternating current 50/60 Hz		$I_e/AC-15$	$I_e/AC-15$	$I_e/AC-12$	$I_e/AC-15$
- At 24 V	A	6	6	10	10
- At 120 V	A	6	3	10	10
- At 240 V	A	3	1.5	10	6
- At 400 V	A	--	--	10	4
- At 500 V	A	--	--	10	3
• For direct current		$I_e/DC-13$	$I_e/DC-13$	$I_e/DC-12$	$I_e/DC-13$
- At 24 V	A	3	3	10	10
- At 125 V	A	0.55	0.55	--	--
- At 250 V	A	0.27	0.27	--	--
- At 110 V	A	--	--	4	4
- At 220 V	A	--	--	1	1
- At 440 V	A	--	--	0.5	0.2
<b>Short-circuit protection</b>					
• With DIAZED fuse links, operational class gG	A	6	6		
• With fuse links, quick		--	10		
• With miniature circuit breaker, Char. C	A	1	2	--	
<b>Mechanical endurance</b>		1 × 10 <sup>6</sup> operating cycles			
<b>Electrical endurance</b>					
• With 3RH.1, 3RT contactors in size S00, S0		10 × 10 <sup>6</sup> operating cycles		> 1 × 10 <sup>6</sup> operating cycles	
• For utilization category AC-15 when switching off $I_e/AC-15$ at 240 V		0.1 × 10 <sup>6</sup> operating cycles		0.5 × 10 <sup>6</sup> operating cycles	
<b>Switching frequency</b>		6000 operating cycles/h			
With 3RH.1, 3RT contactors in size S00, S0					
<b>Minimum pull-out force</b> for positive opening	N	20	10	30	

# 3SE5, 3SE2 position switches





## With separate actuator

3SE5, molded-plastic enclosures  
Enclosure width 31 mm acc. to EN 50047/50 mm

### Selection and ordering data

#### Complete units

2 or 3 contacts · 5 directions of approach · Degree of protection IP65 (31 mm) or IP66 / IP67 (50 mm) · Cable entry M20 × 1.5

Version <sup>1)</sup>	Contacts	LEDs	DT	Complete units	Order No.
<b>Enclosure width 31 mm according to EN 50047</b>					
	<b>5 directions of approach</b>				
	Slow-action contacts	1 NO + 1 NC --	⊕ B	<b>3SE5 232-0RV40</b>	
	Slow-action contacts	1 NO + 2 NC --	⊕ ▶ B	<b>3SE5 232-0QV40</b>	
<b>With increased minimum pull-out force 30 N</b>					
	Slow-action contacts	1 NO + 2 NC --	⊕ B	<b>3SE5 232-0QV40-1AA1</b>	
With separate actuator					
	<b>With M12 connector socket, 4-pole (250 V, 4 A)</b>				
	Slow-action contacts	1 NO + 1 NC --	⊕ B	<b>3SE5 234-0RV40-1AC4</b>	
	Slow-action contacts	2 NC --	⊕ B	<b>3SE5 234-0QV40-1AE0</b>	
With M12 socket					
	<b>With 2 LEDs, yellow/green</b>				
	Slow-action contacts	1 NO + 1 NC 24 V DC	⊕ B	<b>3SE5 232-1RV40</b>	
	Slow-action contacts	1 NO + 1 NC 230 V AC	⊕ B	<b>3SE5 232-3RV40</b>	
<b>With M12 connector socket, 5-pole (125 V, 4 A) and 2 LEDs</b>					
	Slow-action contacts	1 NO + 1 NC 24 V DC	⊕ B	<b>3SE5 234-1RV40-1AF3</b>	
With 2 LEDs					
<b>Enclosure width 50 mm</b>					
	<b>5 directions of approach</b>				
	Slow-action contacts	1 NO + 2 NC --	⊕ B	<b>3SE5 242-0QV40</b>	
	<b>With increased minimum pull-out force 30 N</b>				
	Slow-action contacts	1 NO + 1 NC --	⊕ B	<b>3SE5 242-0RV40-1AA1</b>	
With separate actuator					
	<b>With 2 LEDs, yellow/green</b>				
	Slow-action contacts	1 NO + 2 NC 24 V DC	⊕ B	<b>3SE5 242-1QV40</b>	
	Slow-action contacts	1 NO + 2 NC 230 V AC	⊕ B	<b>3SE5 242-3QV40</b>	
With 2 LEDs					

⊕ Positive opening according to IEC 60947-5-1, Appendix K.

<sup>1)</sup> Supplied without actuator. Please order separately (see page 2/51).

# 3SE5, 3SE2 position switches

## With separate actuator

3SE5, molded-plastic enclosures  
Enclosure width 40 mm according to EN 50041

### Selection and ordering data

#### Complete units

2 or 3 contacts · 5 directions of approach · Degree of protection IP66 / IP67 · Cable entry M20 × 1.5

Version <sup>1)</sup>	Contacts	LEDs	DT	Complete units
				<input type="checkbox"/>
				Order No.

#### Enclosure width 40 mm according to EN 50041



##### 5 directions of approach

Slow-action contacts

1 NO + 2 NC --

⊕ A

**3SE5 132-0QV20**

With separate actuator



##### With 2 LEDs, yellow/green

Slow-action contacts

1 NO + 2 NC 24 V DC

⊕ B

**3SE5 132-1QV20**

Slow-action contacts

1 NO + 2 NC 230 V AC

⊕ C

**3SE5 132-3QV20**

With 2 LEDs

⊕ Positive opening according to IEC 60947-5-1, Appendix K.

<sup>1)</sup> Supplied without actuator. Please order separately (see page 2/51).

# 3SE5, 3SE2 position switches

## With separate actuator

3SE5, metal enclosures  
Enclosure width 31 mm according to EN 50047

### Selection and ordering data

#### Complete units

2 or 3 contacts · 5 directions of approach · IP66 / IP67 · Cable entry M20 × 1.5

Version <sup>1)</sup>	Contacts	LEDs	DT	Complete units
				<input type="checkbox"/>
				Order No.

#### Enclosure width 31 mm according to EN 50047



##### 5 directions of approach

Slow-action contacts	1 NO + 1 NC --	⊕ A	<b>3SE5 212-0RV40</b>
Slow-action contacts	1 NO + 2 NC --	⊕ B	<b>3SE5 212-0QV40</b>

With separate actuator



##### With 2 LEDs, yellow/green

Slow-action contacts	1 NO + 1 NC 24 V DC	⊕ B	<b>3SE5 212-1RV40</b>
Slow-action contacts	1 NO + 1 NC 230 V AC	⊕ B	<b>3SE5 212-3RV40</b>

With 2 LEDs

⊕ Positive opening according to IEC 60947-5-1, Appendix K.

<sup>1)</sup> Supplied without actuator. Please order separately (see page 2/51).

# 3SE5, 3SE2 position switches

## With separate actuator

3SE5, metal enclosures  
Enclosure width 40 mm acc. to EN 50041/56 mm

### Selection and ordering data

#### Complete units

2 or 3 contacts · 5 directions of approach · Degree of protection IP66 / IP67 · Cable entry M20 × 1.5

Version <sup>1)</sup>	Contacts	LEDs	DT	Complete units
				Order No. <input type="text"/>

#### Enclosure width 40 mm according to EN 50041



With separate actuator

##### 5 directions of approach

Slow-action contacts 1 NO + 2 NC -- ▶ **3SE5 112-0QV10**

##### With increased minimum pull-out force 30 N

Slow-action contacts 1 NO + 2 NC -- ▶ **3SE5 112-0QV10-1AA7**



With M12 socket

##### With M12 connector socket, 5-pole (125 V, 4 A)

Slow-action contacts 1 NO + 1 NC -- B **3SE5 114-0RV10-1AC5**

Slow-action contacts 2 NC -- B **3SE5 114-0QV10-1AE1**

##### With connector socket, 6-pole + PE (250 V, 10 A)

Slow-action contacts 1 NO + 2 NC -- B **3SE5 115-0QV10-1AD1**



With 2 LEDs

##### With 2 LEDs, yellow/green

Slow-action contacts 1 NO + 2 NC 24 V DC B **3SE5 112-1QV10**

Slow-action contacts 1 NO + 2 NC 230 V AC B **3SE5 112-3QV10**

##### With M12 connector socket, 5-pole (125 V, 4 A) and 2 LEDs

Slow-action contacts 1 NO + 1 NC 24 V DC B **3SE5 114-1RV10-1AF3**

##### With connector socket, 6-pole + PE (10 A), and 2 LEDs

Slow-action contacts 1 NO + 1 NC 24 V DC B **3SE5 115-1RV10-1AF2**

#### Enclosure width 56 mm



With separate actuator

##### 5 directions of approach

Slow-action contacts 1 NO + 2 NC -- B **3SE5 122-0QV10**

##### With increased minimum pull-out force 30 N

Slow-action contacts 1 NO + 2 NC -- B **3SE5 122-0QV10-1AA7**



With 2 LEDs

##### With 2 LEDs, yellow/green

Slow-action contacts 1 NO + 2 NC 24 V DC B **3SE5 122-1QV10**

Slow-action contacts 1 NO + 2 NC 230 V AC B **3SE5 122-3QV10**

Positive opening according to IEC 60947-5-1, Appendix K.

<sup>1)</sup> Supplied without actuator. Please order separately (see page 2/51).













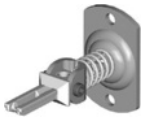

# 3SE5, 3SE2 position switches

## With separate actuator

Accessories

## Selection and ordering data

Version	DT	Order No.
<b>Actuators for 3SE5</b>		
 3SE5 000-0AV01		<b>Standard actuators</b> • Length 75.6 mm ▶ <b>3SE5 000-0AV01</b>
 3SE5 000-0AV02	A	• With vertical fixing, length 53 mm <b>3SE5 000-0AV02</b>
 3SE5 000-0AV03	A	• With transverse fixing, length 47 mm <b>3SE5 000-0AV03</b>
 3SE5 000-0AV04	A	<b>Radius actuators,</b> length 51 mm • Direction of approach from the left • Direction of approach from the right <b>3SE5 000-0AV04</b> <b>3SE5 000-0AV06</b>
 3SE5 000-0AV06	A	
 3SE5 000-0AV05	A	<b>Universal radius actuators,</b> length 77 mm <b>3SE5 000-0AV05</b>
 3SE5 000-0AV07	A	<b>Universal radius actuators, heavy-duty</b> • Length 67 mm • Length 77 mm <b>3SE5 000-0AV07-1AK2</b> <b>3SE5 000-0AV07</b>
 3SE5 000-0AV07	A	
<b>Optional accessories for 3SE5</b>		
 3SE5 000-0AV08-1AA2	B	<b>Protective caps</b> made of black rubber for the actuator head, to protect the actuator openings from contamination (Only for enclosure width 40 or 56 mm) <b>3SE5 000-0AV08-1AA2</b>
 3SE5 000-0AV08-1AA3	C	<b>Blocking inserts,</b> high-grade steel, for actuator head, for up to 8 padlocks <b>3SE5 000-0AV08-1AA3</b>
<b>Connections for 3SE5, 3SE2</b>		
 3SY3 127	B	<b>Connector sockets (4-pole), M12, fixed for M20 × 1.5</b> For max. 250 V, 4 A With 0.25 mm <sup>2</sup> connecting cable, plastic, degree of protection IP67, ambient temperature -40 to +85 °C <b>3SY3 127</b>
 3SY3 128	B	<b>Connector sockets (5-pole), M12, fixed for M20 × 1.5</b> For max. 125 V, 4 A With 0.25 mm <sup>2</sup> connecting cable, plastic, degree of protection IP67, ambient temperature -40 to +85 °C <b>3SY3 128</b>
 3SX9 926	A	<b>Cable glands M20 × 1.5</b> Plastic <b>3SX9 926</b>

2

# 3SE5, 3SE2 position switches

## With separate actuator

3SE2, molded-plastic enclosures  
Enclosure width 52 mm

### Selection and ordering data

#### Complete units

1 or 3 contacts · 3 directions of approach · Degree of protection IP67

Version	Operation	DT	Complete units	
			Order No. <input type="text"/>	
<b>Molded-plastic enclosures in special width of 52 mm</b>				
 <p>3SE 2 243</p>	<b>Lateral and front-end actuation<sup>1)</sup></b> • With M20 × 1.5 connecting thread - Slow-action contacts 1 NO + 2 NC	6 mm stroke  Holding force 5 N Holding force 30 N With automatic ejection	➔ ▶ <b>3SE2 243-0XX40</b> ➔ ▶ <b>3SE2 243-0XX</b> ➔ ▶ <b>3SE2 243-0XX30</b>	
	- Slow-action contacts 1 NC	Holding force 5 N Holding force 30 N With automatic ejection	➔ ▶ <b>3SE2 257-6XX40</b> ➔ ▶ <b>3SE2 257-6XX</b> ➔ B <b>3SE2 257-6XX30</b>	
	• With M16 × 1.5 connecting thread - Slow-action contacts 1 NO + 2 NC	Holding force 5 N Holding force 30 N With automatic ejection	➔ B <b>3SE2 243-0XX48</b> ➔ A <b>3SE2 243-0XX18</b> ➔ C <b>3SE2 243-0XX38</b>	
	- Slow-action contacts 1 NC	Holding force 5 N Holding force 30 N With automatic ejection	➔ B <b>3SE2 257-6XX48</b> ➔ C <b>3SE2 257-6XX18</b> ➔ ▶ <b>3SE2 257-6XX38</b>	
	<b>Accessories</b>			
	 <p>3SX3 218</p>  <p>3SX3 228</p>  <p>3SX3 256</p>  <p>3SX3 217</p>  <p>3SX3 234</p>	<b>Actuators</b> • Standard actuators ( $r_{\min} = 150$ mm), length 28 mm	A	<b>3SX3 218</b>
		• Universal radius actuators ( $r_{\min} = 45$ mm), length 34 mm	A	<b>3SX3 228</b>
		• Radius actuators, adjustable radius, length 34 mm	D	<b>3SX3 256</b>
		• Ball locating, force adjustable up to 100 N by 2 screws, length 28 mm	A	<b>3SX3 217</b>
		• Actuators, length 34 mm, with dust protection and slit cover	D	<b>3SX3 234</b>
	<b>Accessories</b>			
	• Slot covers (1 set = 3 units)	D	<b>3SX3 233</b>	

➔ Positive opening according to IEC 60947-5-1, Appendix K.

<sup>1)</sup> Supplied without actuator.

### Overview

The position switches with interlocking are exceptional safety-related devices which prevent an unforeseen or intentional opening of protective doors, protective grills or other covers as long as a dangerous situation is present (i.e. follow-on motion of the switched off machine).



Position switches with interlocking

The safety position switches with interlocking are comprised of a switch part with electromechanical interlock and a mechanical actuator which has to be ordered separately.

They are rugged protective devices that enable the greatest possible safety for man and machine.

The position switches with interlocking are offered in plastic or metal enclosures.

Dimensions (W × H × D):

- 3SE5 3: 54 mm × 185 mm × 43.5 mm,
- 3SE2 8: 90 mm × 100 mm (+ head 41.3 mm) × 45 mm.

### Operation

The actuator head is included in the scope of supply. For actuation from four directions it can be adjusted through  $4 \times 90^\circ$ . The 3SE5 3 switches can also be approached from above.

The actuators are not included in the scope of supply of the position switch and must be ordered separately from a choice of six versions to suit the application (see page 2/59).

Actuation data:

- Maximum actuating speed  $v_{\max} = 1.5 \text{ m/s}$
- Minimum actuating speed  $v_{\min} = 0.4 \text{ mm/s}$
- Minimum force in the direction of actuation  $F_{\min} = 30 \text{ N}$

The actuator is encoded. Simple overruling by hand or auxiliary devices is impossible.

### Radius actuators

The position switches with radius actuators are particularly suitable for rotatable protective devices. The movable actuation key allows even small radii to be approached. Damage to the switch and the actuator due to inaccurate approach is prevented.

### Locking devices

A high-grade steel locking device for attaching up to eight padlocks is available for even more safety (see page 2/59).

### Dust protection

A rubber cap to protect the twist actuator from contamination is available for operation in dusty environments (see page 2/59).

### Interlocking

There are two versions for locking the actuator:

- Spring-actuated lock (closed-circuit principle) with various release mechanisms
- Solenoid lock (open-circuit principle)

The spring-actuated switch is equipped with an auxiliary release for emergency situations or setup mode. Available as options:

- Escape release or
- Emergency release

### Contact blocks

The position switches with interlocking have one switching block each for:

- Monitoring the actuator or the position of the protective door
- Monitoring the position of the solenoid

The mechanical design of the switch corresponds to the requirements of the failsafe principle according to EN 1088.

### Optical signaling equipment

The position switches with interlocking are available with an optional optical signaling device.

The signaling device indicates the switch position of the lock and the protective device optically by means of 2 LEDs on the front.

Protective device	Solenoid interlocking	Display	Meaning
Closed	Released		Actuator to be pulled
Closed	Locked		Actuator locked
Open	Released		Actuator pulled

### Note:

The voltage of the LEDs at the monitored contacts must be the same as the operational voltage of the solenoid (same potential).

# 3SE5, 3SE2 position switches

## With interlocking

### General data

#### Benefits

The new generation of 3SE5 3 position switches offers:

- More safety through higher locking forces:
  - 1300 N with molded-plastic enclosure
  - 2600 N with metal enclosure
- Various release mechanisms: lock release, escape release and emergency release
- Two contact blocks each with three contacts as standard equipment, hence fewer versions needed
- Same dimensions for all enclosure variants: Plastic, metal or with integrated ASIsafe
- An extensive range of actuators
- An optional LED status display 24 V DC, 115 V AC or 230 V AC for all switch versions
- Device with ASIsafe electronics integrated in the enclosure (see page 2/86).

#### Application

The position switches with interlocking are exceptional safety-related devices which prevent an unforeseen or intentional opening of protective doors, protective grills or other covers as long as a dangerous situation is present (i.e. follow-on motion of the switched off machine).

The safety position switches with interlocking have the following functions:

- Enabling the machine or process with closed and locked protective device
- Locking the machine or process with opened protective device
- Position monitoring of the protective device and interlocking

#### Standards

The switches comply with the standards IEC 60947-1 (Low-Voltage Switchgear and Controlgear, General) and IEC 60947-5-1 (Electromechanical Control Circuit Devices).

The mechanical design of the switch corresponds to the requirements of the failsafe principle according to EN 1088.

#### Approvals

The switches are approved for use with locking devices according to EN 1088 and EN 292, Parts 1 and 2.

3SE5 3 position switches with interlocking bear the VDE test mark for tested according to GS-ET19 (Test Principles of the German Trade Association for Locking Devices with Electromagnetic Interlocks).

3SE2 8 metal-enclosed position switches with interlocking have been awarded a test certificate from the BIA (Berufsgenossenschaftliches Institut für Arbeitssicherheit).

Category 3 according to ISO 13849-1 (EN 954-1) can be attained with a position switch with interlocking if the corresponding failsafe evaluation units are selected and correctly installed, e.g. the 3TK28 safety relays or matching units from the ASIsafe, SIMATIC or SINUMERIK product ranges.

Category 4 can be achieved when using an additional position switch.

These switches are approved according to UL 508, UL 50 and UL 746-C.

#### Interlocking

The separate actuator operates in a similar way to the coding of a key and protects against manipulation. It transmits the locking force to the protective device and helps to monitor its position.

There are two versions of locking:

#### Spring-actuated lock (closed-circuit principle)

- In the standard version, the position switch locks by means of spring force and releases by means of electromagnetic force. In the case of voltage failure, it reliably prevents the protective device from opening when machine parts are still moving.
- The switch is equipped with an auxiliary release for emergency situations or setup mode.
- An auxiliary release which can be secured with a lock to prevent misuse is available as a version.

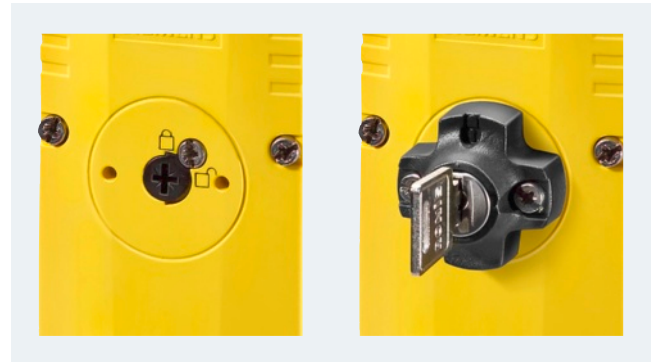

Auxiliary release

Auxiliary release with lock

The new 3SE5 3 position switches are also available with an escape release or emergency release.

- Personnel working inside the hazard zone can use the escape release feature to manually release the interlocking without tools from the escape side (hazardous area side) so that they can exit the hazard area. An intentional act (in this case pulling the gray actuator) is required to release the locking mechanism and restore the normal operating state.
- The emergency release enables someone in an emergency situation to manually release the interlock without tools from the access side (outside the hazardous area). Releasing the lock and restoring the normal operating state must require effort which is comparable to repair activity, in this case disassembly of the red actuator and resetting the mechanical lock.

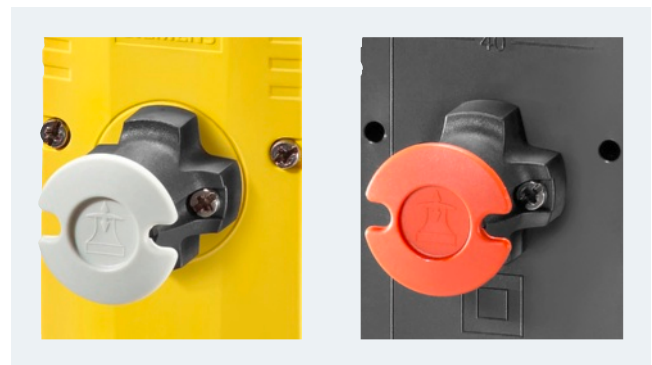

Escape release from the front

Emergency release from the back

#### Solenoid lock (open-circuit principle)

- The second version offers locking by means of electromagnetic force and release by means of spring force. This version has an advantage when it is necessary to quickly access the machine after a power failure occurs, or in the case of very short coasting times.

# 3SE5, 3SE2 position switches

## With interlocking

General data

### Examples of door interlocking



X-Lock door interlocking from Axelent



Door interlocking from Brühl

If you require door interlockings our sales managers will be glad to assist you:

Location (Germany)	Name
<b>Hamburg,</b> Bremen, Kiel, Rostock	<b>Jörg Bahnmann</b> Tel.: (0 40) 28 89-58 63 Fax: (0 40) 28 89-26 11 E-mail: joerg.bahnmann@siemens.com
<b>Hannover,</b> Bielefeld, Braunschweig, Kassel	<b>Dirk Seemann</b> Tel.: (05 11) 8 77-14 53 Fax: (05 11) 8 77-21 90 E-mail: dirk.seemann@siemens.com
<b>Berlin,</b> Chemnitz, Dresden, <b>Erfurt,</b> Leipzig Magdeburg	<b>Rene Wellnitz</b> Tel.: (0 30) 3 86-3 29 78 Fax: (0 30) 3 86-3 32 79 E-mail: rene.wellnitz@siemens.com
<b>Essen,</b> Aachen, Düsseldorf, Köln, Münster, Osnabrück, Siegen, Wuppertal	<b>Torsten Reil</b> Tel.: (02 01) 8 16-24 84 Fax: (02 01) 8 16-36 21 E-mail: torsten.reil@siemens.com
<b>Mannheim,</b> Frankfurt, Koblenz, Saarbrücken, Wetzlar	<b>Jürgen Bolz</b> Tel.: (06 21) 4 56-28 47 Fax: (06 21) 4 56-11 10 E-mail: juergen.bolz@siemens.com
<b>Nürnberg,</b> Augsburg, Bayreuth, Kempten, München, Regensburg, Würzburg	<b>Jens-Uwe Hohler</b> Tel.: (09 11) 6 54-73 44 Fax: (09 11) 6 54-34 36 E-mail: jens-uwe.hohler@siemens.com
<b>Stuttgart,</b> Freiburg, Heilbronn, Karlsruhe, Ulm	<b>Frank Schätzle</b> Tel.: (07 61) 27 12-24 1 Fax: (07 61) 27 12-44 1 E-mail: frank.schaetzle@siemens.com

# 3SE5, 3SE2 position switches

## With interlocking

### General data

### Technical specifications

Type		3SE5 322	3SE5 312	3SE2 83, 3SE2 84	
<b>General data</b>					
<b>Standards</b>		IEC 60947-5-1, EN 60947-5-1			
<b>Rated insulation voltage <math>U_i</math></b>	V	250			
<b>Pollution degree</b> acc. to EN 60664-1		Class 3			
<b>Rated impulse withstand voltage <math>U_{imp}</math></b>	kV	4		6	
<b>Rated operational voltage <math>U_e</math></b>					
• DC	V	24		24	
• AC 50/60 Hz	V	230		110 ... 130    230	
<b>Conventional thermal current <math>I_{th}</math></b>	A	6		10	
<b>Rated operational current <math>I_e</math></b>					
• With alternating current 50/60 Hz		$I_e$ /AC-15 or B300		$I_e$ /AC-12	$I_e$ /AC-15
- At 24 V	A	6		10	4
- At 120 V	A	3		10	4
- At 230 V	A	1.5		10	4
• For direct current		$I_e$ /DC-13 or Q300		$I_e$ /DC-12	$I_e$ /DC-13
- At 24 V	A	3		10	3
- At 125 V	A	0.55		--	--
- At 250 V	A	0.27		--	--
- At 60 V		--		5	1.5
- At 110 V		--		2.5	0.7
- At 220 V		--		1	0.3
<b>Magnet</b>					
• Locking force, max.	N	1300	2600	1820	
• Locking force according to GS-ET 19	N	1000	2000	1400	
• Power consumption at $U_c$	W	3.5		5.2	
<b>Short-circuit protection<sup>1)</sup></b>					
• With DIAZED fuse links, operational class gG	A	6		6	
• With fuse links, quick		--		10	
• With miniature circuit breaker, Char. C	A	0.5		--	
<b>Mechanical endurance</b>		1 × 10 <sup>6</sup> operating cycles		1 × 10 <sup>6</sup> operating cycles	
<b>Electrical endurance</b>					
• With 3RH.1, 3RT contactors in size S00, S0		1 × 10 <sup>6</sup> operating cycles		1 × 10 <sup>6</sup> operating cycles	
• For utilization category AC-15 with interrupting of $I_e$ /AC-15 at 230 V		1 × 10 <sup>5</sup> operating cycles		0.5 × 10 <sup>6</sup> operating cycles	
• With utilization category DC-12/DC-13		For direct current depending on the loading of the switch			
<b>Switching frequency</b>		6000 operating cycles/h			
With 3RH.1, 3RT contactors in size S00, S0					
<b>Shock resistance</b> acc. to IEC 60068-2-27		30 g/11 ms		--	

# 3SE5, 3SE2 position switches

## With interlocking

3SE5, molded-plastic enclosures  
With locking force up to 1200 N

### Selection and ordering data

6 slow-action contacts · 5 directions of approach · Degree of protection IP66 / IP67 · Cable entry 3 × M20 × 1.5  
Locking force 1300 N (1000 N according to GS-ET 19)

Interlock <sup>1)</sup>	LEDs	Solenoid, rated operational voltage	DT	Complete units	
				Position monitoring: Actuators: 1 NO + 2 NC Solenoid: 1 NO + 2 NC	
				Order No.	
V					
<b>1300 N locking force · Enclosure width 54 mm</b>					
<b>Spring-actuated locks</b>					
	• With auxiliary release	--	24 DC	⊕ ▶ <b>3SE5 322-0SD21</b>	
		--	115 AC	⊕ B <b>3SE5 322-0SD22</b>	
		--	230 AC	⊕ B <b>3SE5 322-0SD23</b>	
		Yellow/Green	24 DC	⊕ A <b>3SE5 322-1SD21</b>	
		Yellow/Green	115 AC	⊕ B <b>3SE5 322-2SD22</b>	
		Yellow/Green	230 AC	⊕ B <b>3SE5 322-3SD23</b>	
	• With auxiliary release With lock	--	24 DC	⊕ B <b>3SE5 322-0SE21</b>	
		--	115 AC	⊕ B <b>3SE5 322-0SE22</b>	
		--	230 AC	⊕ B <b>3SE5 322-0SE23</b>	
		Yellow/Green	24 DC	⊕ B <b>3SE5 322-1SE21</b>	
		Yellow/Green	115 AC	⊕ B <b>3SE5 322-2SE22</b>	
		Yellow/Green	230 AC	⊕ B <b>3SE5 322-3SE23</b>	
	• With escape release from the front	--	24 DC	⊕ B <b>3SE5 322-0SF21</b>	
		--	115 AC	⊕ B <b>3SE5 322-0SF22</b>	
		--	230 AC	⊕ B <b>3SE5 322-0SF23</b>	
		Yellow/Green	24 DC	⊕ B <b>3SE5 322-1SF21</b>	
		Yellow/Green	115 AC	⊕ B <b>3SE5 322-2SF22</b>	
		Yellow/Green	230 AC	⊕ B <b>3SE5 322-3SF23</b>	
	• With escape release from the front and emergency release from the back	--	24 DC	⊕ B <b>3SE5 322-0SL21</b>	
		• With escape release from the back and auxiliary release from the front	--	24 DC	⊕ B <b>3SE5 322-0SG21</b>
			--	115 AC	⊕ B <b>3SE5 322-0SG22</b>
			--	230 AC	⊕ B <b>3SE5 322-0SG23</b>
		Yellow/Green	24 DC	⊕ B <b>3SE5 322-1SG21</b>	
		Yellow/Green	115 AC	⊕ B <b>3SE5 322-2SG22</b>	
Yellow/Green	230 AC	⊕ B <b>3SE5 322-3SG23</b>			
	• With escape release from the back and auxiliary release with lock from the front	--	24 DC	⊕ B <b>3SE5 322-0SH21</b>	
		• With emergency release from the back and auxiliary release from the front	--	24 DC	⊕ B <b>3SE5 322-0SJ21</b>
			--	115 AC	⊕ B <b>3SE5 322-0SJ22</b>
	--		230 AC	⊕ B <b>3SE5 322-0SJ23</b>	
	Yellow/Green	24 DC	⊕ B <b>3SE5 322-1SJ21</b>		
	Yellow/Green	115 AC	⊕ B <b>3SE5 322-2SJ22</b>		
	Yellow/Green	230 AC	⊕ B <b>3SE5 322-3SJ23</b>		
		<b>Solenoid locks</b>	--	24 DC	⊕ ▶ <b>3SE5 322-0SB21</b>
			--	115 AC	⊕ B <b>3SE5 322-0SB22</b>
--			230 AC	⊕ B <b>3SE5 322-0SB23</b>	
Yellow/Green			24 DC	⊕ A <b>3SE5 322-1SB21</b>	
Yellow/Green			115 AC	⊕ B <b>3SE5 322-2SB22</b>	
Yellow/Green	230 AC	⊕ B <b>3SE5 322-3SB23</b>			

⊕ Positive opening according to IEC 60947-5-1, Appendix K.

<sup>1)</sup> Supplied without actuator. Please order separately (see page 2/59).

# 3SE5, 3SE2 position switches

## With interlocking

3SE5, metal enclosures  
With locking force up to 2000 N

### Selection and ordering data

6 slow-action contacts · 5 directions of approach · Degree of protection IP66 / IP67 · Cable entry 3 × M20 × 1.5  
Locking force 2600 N (2000 N according to GS-ET 19)

Interlock <sup>1)</sup>	LEDs	Solenoid, rated operational voltage	DT	Complete units Position monitoring: Actuators: 1 NO + 2 NC Solenoid: 1 NO + 2 NC Order No.
		V		<input type="checkbox"/>

#### 2600 N locking force · Enclosure width 54 mm











Spring-actuated locks					
	• With auxiliary release	--	24 DC	↻ ▶	<b>3SE5 312-0SD11</b>
		--	115 AC	↻ B	<b>3SE5 312-0SD12</b>
		--	230 AC	↻ B	<b>3SE5 312-0SD13</b>
		Yellow/Green	24 DC	↻ B	<b>3SE5 312-1SD11</b>
		Yellow/Green	115 AC	↻ B	<b>3SE5 312-2SD12</b>
		Yellow/Green	230 AC	↻ B	<b>3SE5 312-3SD13</b>
	• With auxiliary release	--	24 DC	↻ B	<b>3SE5 312-0SE11</b>
	With lock	--	115 AC	↻ B	<b>3SE5 312-0SE12</b>
		--	230 AC	↻ B	<b>3SE5 312-0SE13</b>
			48 AC/DC	↻ C	<b>3SE5 312-0SE14</b>
		Yellow/Green	24 DC	↻ B	<b>3SE5 312-1SE11</b>
		Yellow/Green	115 AC	↻ B	<b>3SE5 312-2SE12</b>
	Yellow/Green	230 AC	↻ B	<b>3SE5 312-3SE13</b>	
	• With escape release from the front	--	24 DC	↻ B	<b>3SE5 312-0SF11</b>
		--	115 AC	↻ B	<b>3SE5 312-0SF12</b>
		--	230 AC	↻ B	<b>3SE5 312-0SF13</b>
		Yellow/Green	24 DC	↻ B	<b>3SE5 312-1SF11</b>
		Yellow/Green	115 AC	↻ B	<b>3SE5 312-2SF12</b>
		Yellow/Green	230 AC	↻ B	<b>3SE5 312-3SF13</b>
	• With escape release from the back and auxiliary release from the front	--	24 DC	↻ B	<b>3SE5 312-0SG11</b>
		--	115 AC	↻ B	<b>3SE5 312-0SG12</b>
		--	230 AC	↻ B	<b>3SE5 312-0SG13</b>
		Yellow/Green	24 DC	↻ B	<b>3SE5 312-1SG11</b>
		Yellow/Green	115 AC	↻ B	<b>3SE5 312-2SG12</b>
		Yellow/Green	230 AC	↻ B	<b>3SE5 312-3SG13</b>
	• With escape release from the back and auxiliary release with lock from the front	--	24 DC	↻ B	<b>3SE5 312-0SH11</b>
	• With emergency release from the back and auxiliary release from the front	--	24 DC	↻ B	<b>3SE5 312-0SJ11</b>
		--	115 AC	↻ B	<b>3SE5 312-0SJ12</b>
		--	230 AC	↻ B	<b>3SE5 312-0SJ13</b>
		Yellow/Green	24 DC	↻ B	<b>3SE5 312-1SJ11</b>
		Yellow/Green	115 AC	↻ B	<b>3SE5 312-2SJ12</b>
	Yellow/Green	230 AC	↻ B	<b>3SE5 312-3SJ13</b>	
	<b>Solenoid locks</b>	--	24 DC	↻ ▶	<b>3SE5 312-0SB11</b>
		--	115 AC	↻ B	<b>3SE5 312-0SB12</b>
		--	230 AC	↻ B	<b>3SE5 312-0SB13</b>
		Yellow/Green	24 DC	↻ B	<b>3SE5 312-1SB11</b>
		Yellow/Green	115 AC	↻ B	<b>3SE5 312-2SB12</b>
		Yellow/Green	230 AC	↻ B	<b>3SE5 312-3SB13</b>

↻ Positive opening according to IEC 60947-5-1, Appendix K.

<sup>1)</sup> Supplied without actuator. Please order separately (see page 2/59).



### Selection and ordering data

Version	DT	Order No.
<b>Actuators for 3SE5</b>		
 3SE5 000-0AV01	<b>Standard actuators</b> <ul style="list-style-type: none"> <li>Length 75.6 mm</li> </ul>	▶ <b>3SE5 000-0AV01</b>
 3SE5 000-0AV02	<ul style="list-style-type: none"> <li>With vertical fixing, length 53 mm</li> </ul>	A <b>3SE5 000-0AV02</b>
 3SE5 000-0AV03	<ul style="list-style-type: none"> <li>With transverse fixing, length 47 mm</li> </ul>	A <b>3SE5 000-0AV03</b>
 3SE5 000-0AV04	<b>Radius actuators,</b> length 51 mm <ul style="list-style-type: none"> <li>Direction of approach from the left</li> <li>Direction of approach from the right</li> </ul>	A <b>3SE5 000-0AV04</b> A <b>3SE5 000-0AV06</b>
 3SE5 000-0AV05	<b>Universal radius actuators,</b> length 77 mm	A <b>3SE5 000-0AV05</b>
 3SE5 000-0AV07	<b>Universal radius actuators, heavy-duty</b> <ul style="list-style-type: none"> <li>Length 67 mm</li> <li>Length 77 mm</li> </ul>	A <b>3SE5 000-0AV07-1AK2</b> A <b>3SE5 000-0AV07</b>
<b>Optional accessories for 3SE5</b>		
 3SE5 000-0AV08-1AA2	<b>Protective caps</b> made of black rubber for the actuator head, to protect the actuator openings from contamination	B <b>3SE5 000-0AV08-1AA2</b>
 3SE5 000-0AV08-1AA3	<b>Blocking inserts</b> , high-grade steel, for actuator head, for up to 8 padlocks	C <b>3SE5 000-0AV08-1AA3</b>
<b>Spare parts for 3SE5</b>		
	<b>Spare keys</b>	B <b>3SX5 100-1F</b>
<b>Connections for 3SE5, 3SE2</b>		
 3SY3 127	<b>Connector sockets (4-pole), M12, fixed for M20 x 1.5</b> For max. 250 V, 4 A With 0.25 mm <sup>2</sup> connecting cable, plastic, degree of protection IP67, ambient temperature -40 to +85 °C	B <b>3SY3 127</b>
	<b>Connector sockets (5-pole), M12, fixed for M20 x 1.5</b> For max. 125 V, 4 A With 0.25 mm <sup>2</sup> connecting cable, plastic, degree of protection IP67, ambient temperature -40 to +85 °C	B <b>3SY3 128</b>
 3SX9 926	<b>Cable glands M20 x 1.5</b> Plastic	A <b>3SX9 926</b>

# 3SE5, 3SE2 position switches

## With interlocking

**3SE2, metal enclosures**  
With locking force up to 1800 N

### Selection and ordering data

4 slow-action contacts · 4 directions of approach · Locking force 1800 N (1400 N acc. to GS-ET 19) · Degree of protection IP67

Interlock/ Signaling equipment	Slow-action contacts		Solenoid	Rated operational voltage V	Complete units	Weight, approx. kg					
	Position monitoring	Actuators					Solenoid				
 <p>With auxiliary release</p>	<b>Spring-actuated locks<sup>1)</sup></b> 6 mm stroke		24 DC	⊕	3SE2 840-0XX00	0.885					
	• Auxiliary release, sealable	1 NO + 1 NC					2 NC	110 AC	⊕	3SE2 842-0XX00	0.890
			<b>Spring-actuated locks<sup>1)</sup></b> 6 mm stroke		24 DC	⊕					
	• Auxiliary release with lock	1 NO + 1 NC	2 NC	110 AC			⊕	3SE2 842-0XX01	0.925		
										230 AC	⊕
					<b>Magnetic field locks<sup>1)</sup></b>						
	• Standard	1 NO + 1 NC	2 NC	110 AC	⊕	3SE2 832-0XX00	0.855				
								230 AC	⊕	3SE2 831-0XX00	0.855
	• Auxiliary release, sealable	2 NC	2 NC	110 AC	⊕	3SE2 842-6XX00	0.880				
								230 AC	⊕	3SE2 841-6XX00	0.880
<b>Spring-actuated locks<sup>1)</sup></b> 6 mm stroke											
• Auxiliary release with lock	2 NC	2 NC	110 AC	⊕	3SE2 842-6XX01	0.960					
							230 AC	⊕	3SE2 841-6XX01	0.925	
											<b>Magnetic field locks<sup>1)</sup></b>
• Standard	2 NC	2 NC	110 AC	⊕	3SE2 832-6XX00	0.855					
							230 AC	⊕	3SE2 831-6XX00	0.850	
											<b>Spring-actuated locks<sup>1)</sup></b> 6 mm stroke
• Auxiliary release, sealable	1 NO + 1 NC	1 NO + 1 NC	110 AC	⊕	3SE2 842-1XX00	0.890					
							230 AC	⊕	3SE2 841-1XX00	0.870	
											<b>Spring-actuated locks<sup>1)</sup></b> 6 mm stroke
• Auxiliary release, sealable, and with optical signaling equipment <sup>2)</sup>	1 NO + 1 NC	1 NO + 1 NC	110 AC	⊕	3SE2 842-1XX20	0.885					
							230 AC	⊕	3SE2 841-1XX20	0.880	
											<b>Spring-actuated locks<sup>1)</sup></b> 6 mm stroke
• Auxiliary release with lock and with optical signaling equipment <sup>2)</sup>	1 NO + 1 NC	1 NO + 1 NC	110 AC	⊕	3SE2 842-1XX32	0.935					
							230 AC	⊕	3SE2 841-1XX32	0.930	
											<b>Magnetic field locks<sup>1)</sup></b>
• Standard	1 NO + 1 NC	1 NO + 1 NC	110 AC	⊕	3SE2 832-1XX00	0.855					
							230 AC	⊕	3SE2 831-1XX00	0.875	
											<b>Spring-actuated locks<sup>1)</sup></b> 6 mm stroke
• With optical signaling equipment <sup>2)</sup>	1 NO + 1 NC	1 NO + 1 NC	110 AC	⊕	3SE2 832-1XX20	0.865					
							230 AC	⊕	3SE2 831-1XX20	0.875	
											<b>Actuators</b>
• Standard actuator, length 79 mm											
- For approach from the left, length 132 mm		3SX3 207	0.045								
- With transverse fixing, length 50 mm											
- With vertical fixing, length 50 mm		3SX3 306	0.025								
- With vertical fixing, length 50 mm											
• Universal radius actuator, length 80 mm		3SX3 203	0.120								

⊕ Positive opening according to IEC 60947-5-1, Appendix K.

<sup>1)</sup> Supplied without actuator.

<sup>2)</sup> The version with optical signaling equipment have contacts which are not electrically isolated.

### Overview

3SE5 hinge switches have the same enclosures as the standard switches (modular system).



Hinge switches

### Design

#### Enclosure sizes

The 3SE5 switches are available as complete units in two enclosure sizes:

- Molded-plastic enclosures according to EN 50047, 31 mm wide, IP65, 1 cable entry
- Metal enclosures according to EN 50047, 31 mm wide, IP66 / IP67, 1 cable entry
- Plastic and metal enclosures according to EN 50041, 40 mm wide, IP66 / IP67, 1 cable entry

#### Enclosure versions

Various basic versions can be selected for the enclosures:

- Available with two or three-pole switching elements designed as snap-action contacts
- Metal enclosures for explosion protection (ATEX) (see pages 2/69 and 2/73)
- AS-Interface version with integrated ASIsafe electronics for all enclosure designs (see page 2/89)

For a description of the basic switches see page 2/4.

#### Operating mechanism

The hinge switches are provided for mounting on hinges. The actuator head is included in the scope of supply. There are two versions:

- Operating mechanism with hollow shaft, inner diameter 8 mm, outer 12 mm
- Operating mechanism with solid shaft, diameter 10 mm

### Benefits

The 3SE5 hinge switches differ from the previous series through the following new characteristics:

- All actuators can be turned around the axis in increments of 22.5° (see picture on page 2/5).
- The new three-pole contact block 1 NO + 2 NC is available for all enclosure sizes (see picture on page 2/5).
- The molded-plastic enclosure with a width of 31 mm has simple and fast wiring equipment which makes it possible to save from approx. 20 to 25 % of the time when connecting (see picture on page 2/5).
- The ASIsafe electric component is integrated for the versions with the AS-Interface connection (see page 2/74); an additional adapter is not required.

### Application

The hinge switches are used in those areas where the position of swivelable protective devices such as doors or flaps must be monitored. The position of the doors and hinge switches is converted into electric signals with the switches. The switches allows shutdown and signaling without delay in the event of a small opening angle through the snap-action contacts with an operating angle of 10°.

Devices are available with enclosure versions to suit the particular ambient conditions. Different control tasks can be performed with the best contact blocks suited for the particular purpose. Dimensions and fixing points of the enclosures are in accordance with EN 50041 or EN 50047 standards.

The devices are suitable for use in any climate.

#### Standards

IEC 60947-5-1 or EN 60947-5-1.

The protective measure of "total insulation" by the molded-plastic enclosure is guaranteed by the use of molded-plastic screw-glands.

#### Safety position switches

For controls according to IEC 60204-1 or EN 60204-1 the devices can be used as a safety position switch. To secure position switches against changes in their position, keyed techniques must be employed on installation.

#### Safety circuits

IEC 60947-5-1 and EN 60947-5-1 require positive opening of the NC contacts, i.e. for the purposes of personal safety, the assured opening of NC contacts is expressly stipulated for the electrical equipment of machines in all safety circuits and marked according to IEC 60947-5-1 with the symbol ☞.

Category 4 according to EN 954-1 can be attained with the 3SE5 hinge switches with ☞ if the corresponding failsafe evaluation units are selected and correctly installed, e.g. the 3TK28 safety relays or matching devices from the ASIsafe, SIMATIC or SINUMERIK product ranges.

# 3SE5, 3SE2 position switches

## Hinge switches

3SE5, molded-plastic enclosures  
Enclosure width 31 mm / 40 mm

### Selection and ordering data

#### Complete units

2 or 3 contacts · Degree of protection IP65 (31 mm) or IP67/IP68 (40 mm) · Cable entry M20 × 1.5

Version	Snap-action contacts	DT	Complete units
			<input type="checkbox"/>
			Order No.

#### Plastic enclosures · Enclosure width 31 mm according to EN 50047



With hollow shaft

##### With hollow shaft

Operating angle 10°

1 NO + 1 NC ⤴ B

**3SE5 232-0HU21**

Operating angle 10°

1 NO + 2 NC ⤴ B

**3SE5 232-0LU21**



With solid shaft

##### With solid shaft

Operating angle 10°

1 NO + 1 NC ⤴ B

**3SE5 232-0HU22**

Operating angle 10°

1 NO + 2 NC ⤴ B

**3SE5 232-0LU22**

#### Plastic enclosures · Enclosure width 40 mm according to EN 50041



With hollow shaft

##### With hollow shaft

Operating angle 10°

1 NO + 2 NC ⤴ B

**3SE5 132-0LU21**



With solid shaft

##### With solid shaft

Operating angle 10°

1 NO + 2 NC ⤴ B

**3SE5 132-0LU22**

⤴ Positive opening according to IEC 60947-5-1, Appendix K.

#### Accessories/spare parts

Version	DT	Order No.
---------	----	-----------

#### Actuator heads



With hollow shaft

##### With hollow shaft

Operating angle 10°

B **3SE5 000-0AU21**



With solid shaft

##### With solid shaft

Operating angle 10°

B **3SE5 000-0AU22**





#### Note:

The respective actuators are included in the scope of supply for the complete units.

## Selection and ordering data



## Complete units

3 contacts · Degree of protection IP66 / IP67 · Cable entry M20 × 1.5

Version	Snap-action contacts	DT	Complete units	Order No.
<b>Metal enclosures • Enclosure width 31 mm according to EN 50047</b>				
	<b>With hollow shaft</b> Operating angle 10°	1 NO + 2 NC	⊕ B	<b>3SE5 212-0LU21</b>
With hollow shaft				
	<b>With solid shaft</b> Operating angle 10°	1 NO + 2 NC	⊕ B	<b>3SE5 212-0LU22</b>
With solid shaft				
<b>Metal enclosures • Enclosure width 40 mm according to EN 50041</b>				
	<b>With hollow shaft</b> Operating angle 10°	1 NO + 2 NC	⊕ B	<b>3SE5 112-0LU21</b>
With hollow shaft				
	<b>With solid shaft</b> Operating angle 10°	1 NO + 2 NC	⊕ B	<b>3SE5 112-0LU22</b>
With solid shaft				

⊕ Positive opening according to IEC 60947-5-1, Appendix K.

## Accessories/spare parts

Version	DT	Order No.
<b>Actuator heads</b>		
	<b>With hollow shaft</b> Operating angle 10°	B <b>3SE5 000-0AU21</b>
With hollow shaft		
	<b>With solid shaft</b> Operating angle 10°	B <b>3SE5 000-0AU22</b>
With solid shaft		

Note:

The respective actuators are included in the scope of supply for the complete units.

# 3SE5, 3SE2 position switches

## Hinge switches

**3SE2, molded-plastic enclosures**  
With integrated hinge

### Overview

The 3SE2 283 hinge switches are particularly suitable for use in doors and flaps of machines that must be closed to ensure the safety of operating personnel. Their thin profile and compact design allow them to be directly mounted on a hinged protective cover and the stable frame.

### Benefits

- Easy mounting through use of versions with integrated hinge
- Versions with small operating angle of 4°
- Protection against personal injury provided by positively driven NC contacts according to IEC 60947-5-1
- Simultaneous shutdown and reporting by 1 NO + 2 NC contacts

### Technical specifications

Type	3SE2 283	
Rated insulation voltage $U_i$	V	250
Conventional thermal current $I_{th}$	A	2.5
Rated operational current $I_e$		
• At AC-15, 120 V	A	4.2
• At AC-15, 250 V	A	2
• At DC-13, 24 V	A	1
Min. make-break capacity	> 5 V / 1 mA	
Short-circuit protection		
• Operational class gG	A	2
Mechanical endurance	> 1 × 10 <sup>6</sup> operating cycles	
Switching frequency	1200 operating cycles/hour	
Positive opening	2 mm after opening point	
Enclosure material	Plastic	
Degree of protection	IP65	
Ambient temperature	°C	-25 ... +65
Shock resistance	30 g/18 ms	
Resistance to vibrations	20 g/10 ... 200 Hz	
Cable entry	2 × (M20 × 1.5)	
Screw terminals	0.5 ... 1.5 mm <sup>2</sup> /AWG 15	

### Configuration

3SE2 283-GA.3 hinge switch with hinge

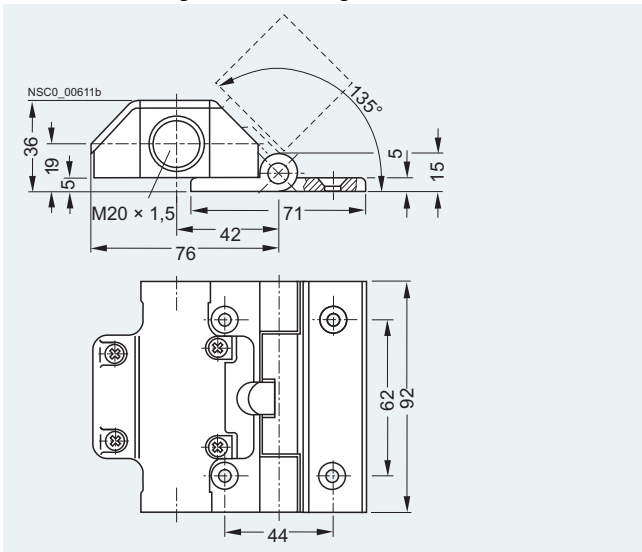

3SX3 225 additional hinge

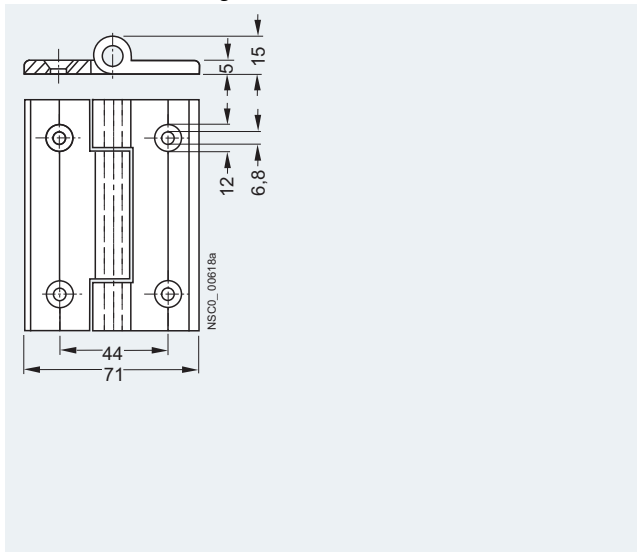

### Operating travel of the hinge

Slow-action contacts

**1 NO + 2 NC, Ident. No. 12**

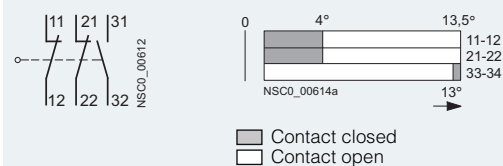

Slow-action contacts

**3 NC, Ident. No. 03**

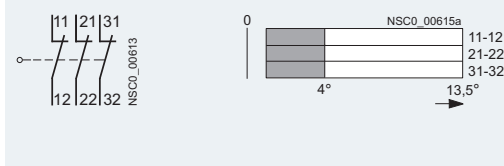

# 3SE5, 3SE2 position switches

## Hinge switches

3SE2, molded-plastic enclosures  
With integrated hinge

### Selection and ordering data

3 contacts · Degree of protection IP65 · Cable entry 2 × (M20 × 1.5)

Version	Slow-action contacts	DT	Complete units	<input type="checkbox"/>
				Order No.

### Molded-plastic enclosures with integrated hinge



3SE2 283

#### With integrated hinge

(Delivery includes additional hinge and fixing accessories)

• Aluminum hinge					
- Operating angle 4°	1 NO + 2 NC	↻ A		<b>3SE2 283-0GA43</b>	
- Operating angle 4°	3 NC	↻ B		<b>3SE2 283-6GA43</b>	
- Operating angle 8°	1 NO + 2 NC	↻ C		<b>3SE2 283-0GA53</b>	
- Operating angle 8°	3 NC	↻ C		<b>3SE2 283-6GA53</b>	
• High-grade steel hinge					
- Operating angle 4°	1 NO + 2 NC	↻ B		<b>3SE2 283-0GA44</b>	
- Operating angle 4°	3 NC	↻ C		<b>3SE2 283-6GA44</b>	

↻ Positive opening according to IEC 60947-5-1, Appendix K.

### Accessories/spare parts

Version	DT	Order No.
---------	----	-----------

### Accessories



3SX3 225

#### Additional hinges

(delivered with fixing accessories)

• Made of aluminum	↻ D	<b>3SX3 225</b>
• Made of high-grade steel	↻ D	<b>3SX3 231</b>

# 3SE5, 3SE2 position switches

## For explosion protection (ATEX)

3SE5, metal enclosures  
Enclosure width 31 mm / 40 mm / 56 mm

### Overview



Position switches according to ATEX with grounding screw

Position switches in a metal enclosure including the hinge switch and the switch with a separate actuator are also available in versions for operation in areas with combustible dust.

These switches are not suitable for operation in areas with gas explosion hazard. An exception is the type of protection intrinsic safety i: Use as "simple electrical equipment" is possible (see Certificate No. 2849).

To achieve the maximum possible safety in these areas, the legislators of most countries have drawn up requirements in the form of laws, regulations and standards which these switches comply with to the letter.

These switches comply with Directive 94/9/EC II2D (ATEX 95) of the European Union and are approved for Zone 21/22.

See [www.siemens.com/industrial-controls/atex](http://www.siemens.com/industrial-controls/atex) and Catalog IC 10, chapter 3.

They have a grounding screw on the outside of the enclosure but are otherwise identical with the standard enclosures. The connection openings are closed with protective caps upon delivery.



# 3SE5, 3SE2 position switches

## For explosion protection (ATEX)

3SE5, metal enclosures  
Enclosure width 31 mm according to EN 50047

### Selection and ordering data

#### Modular system

2 or 3 contacts · Degree of protection IP66 / IP67 · Cable entry M20 × 1.5







Version	Contacts	DT	Modular system
			Order No. 

#### Basic switches · Enclosure width 31 mm according to EN 50047 (with rounded plunger<sup>1)</sup>)



Rounded plunger

##### With M20 × 1.5 connecting thread

Slow-action contacts	1 NO + 1 NC		B	<b>3SE5 212-0BC05-1DA0</b>
Snap-action contacts	1 NO + 1 NC		B	<b>3SE5 212-0CC05-1DA0</b>
Slow-action contacts	1 NO + 2 NC		B	<b>3SE5 212-0KC05-1DA0</b>
Snap-action contacts	1 NO + 2 NC		B	<b>3SE5 212-0LC05-1DA0</b>
Slow-action contacts with make-before-break	1 NO + 2 NC		B	<b>3SE5 212-0MC05-1DA0</b>
Slow-action contacts	2 NO + 1 NC		B	<b>3SE5 212-0PC05-1DA0</b>

 Positive opening according to IEC 60947-5-1, Appendix K, or positively driven actuator, necessary in safety circuits.

<sup>1)</sup> On enclosure width 31 mm the basic switch is a complete unit with rounded plunger.

*Note: For selection assistance, see page 2/8.*

Version	Diameter	DT	Modular system
	mm		Order No. 

#### Operating mechanisms



Plain plunger

##### Plain plungers

High-grade steel plungers	10		A	<b>3SE5 000-0AB01</b>
---------------------------	----	---	---	-----------------------



Roller plunger

##### Roller plungers, type C acc. to EN 50047

Plastic rollers	10		A	<b>3SE5 000-0AD03</b>
High-grade steel rollers	10		B	<b>3SE5 000-0AD04</b>



With central fixing





##### Roller plungers with central fixing

Plastic rollers	10		B	<b>3SE5 000-0AD10</b>
High-grade steel rollers	10		B	<b>3SE5 000-0AD11</b>

# 3SE5, 3SE2 position switches

## For explosion protection (ATEX)

3SE5, metal enclosures  
Enclosure width 31 mm according to EN 50047

Version	Diameter	DT	Modular system	
	mm		Order No.	
<b>Operating mechanisms</b>				
	<b>Roller levers, type E acc. to EN 50047</b>			
	Metal lever, plastic roller	13	⊕ A	<b>3SE5 000-0AE10</b>
	Metal lever, high-grade steel roller	13	⊕ B	<b>3SE5 000-0AE11</b>
	High-grade steel lever, plastic roller	13	⊕ B	<b>3SE5 000-0AE12</b>
	High-grade steel lever, high-grade steel roller	13	⊕ B	<b>3SE5 000-0AE13</b>
	<b>Angular roller levers</b>			
	Metal lever, plastic roller	13	⊕ A	<b>3SE5 000-0AF10</b>
	Metal lever, high-grade steel roller	13	⊕ B	<b>3SE5 000-0AF11</b>
	High-grade steel lever, plastic roller	13	⊕ A	<b>3SE5 000-0AF12</b>
	High-grade steel lever, high-grade steel roller	13	⊕ B	<b>3SE5 000-0AF13</b>
<b>Twist actuators</b>				
	<b>Twist actuators, plastic (without lever)</b>			
	Switching right and/or left, adjustable		⊕ A	<b>3SE5 000-0AK00</b>
<b>Levers for twist actuators</b>				
	<b>Twist levers, straight, type A acc. to EN 50047</b>			
	Metal lever 21 mm, plastic roller	19	⊕ A	<b>3SE5 000-0AA21</b>
	Metal lever 21 mm, high-grade steel roller	19	⊕ B	<b>3SE5 000-0AA22</b>
	Metal lever 21 mm, roller with ball bearing	19	⊕ B	<b>3SE5 000-0AA23</b>
	Metal lever 21 mm, plastic roller	30	⊕ B	<b>3SE5 000-0AA25</b>
	High-grade steel lever 21 mm, plastic roller	19	⊕ B	<b>3SE5 000-0AA31</b>
	High-grade steel lever 21 mm, high-grade steel roller	19	⊕ B	<b>3SE5 000-0AA32</b>
	<b>Twist levers 30 mm, straight<sup>1)</sup></b>			
	Metal lever, plastic roller	19	⊕ B	<b>3SE5 000-0AA24</b>
	Metal lever, plastic roller	30	⊕ B	<b>3SE5 000-0AA26</b>
	<b>Twist levers, adjustable length, with grid hole</b>			
	Metal lever, plastic roller	19	⊕ B	<b>3SE5 000-0AA60</b>
	Metal lever, high-grade steel roller	19	⊕ B	<b>3SE5 000-0AA61</b>
	Metal lever, plastic roller	50	⊕ B	<b>3SE5 000-0AA67</b>
	Metal lever, rubber roller	50	⊕ B	<b>3SE5 000-0AA68</b>
	High-grade steel lever, plastic roller	19	⊕ B	<b>3SE5 000-0AA62</b>
	High-grade steel lever, high-grade steel roller	19	⊕ B	<b>3SE5 000-0AA63</b>

⊕ Positively driven actuator, necessary in safety circuits.

<sup>1)</sup> Can be clinch mounted (turned through 180°, rear of lever).

# 3SE5, 3SE2 position switches

## For explosion protection (ATEX)

3SE5, metal enclosures  
Enclosure width 31 mm according to EN 50047

### Position switches with separate actuator · Complete units

5 directions of approach · 3 contacts · Degree of protection IP66 / IP67 · Cable entry M20 × 1.5

Version <sup>1)</sup>	Contacts	DT	Complete units
			<input type="checkbox"/>
			Order No.

#### Enclosure width 31 mm according to EN 50047



With separate actuator

#### With M20 × 1.5 connecting thread

Slow-action contacts

1 NO + 2 NC ⤴ B

**3SE5 212-0QV40-1DA0**

⤴ Positive opening according to IEC 60947-5-1, Appendix K.

<sup>1)</sup> Supplied without actuator. Please order separately (see page 2/51).

### Hinge switches · Complete units

3 contacts · Degree of protection IP66 / IP67 · Cable entry M20 × 1.5

Version	Shap-action contacts	DT	Complete units
			<input type="checkbox"/>
			Order No.

#### Enclosure width 31 mm according to EN 50047



With hollow shaft

#### With hollow shaft, Ø 8/12 mm

Operating angle 10°

1 NO + 2 NC ⤴ B

**3SE5 212-0LU21-1DA0**



With solid shaft

#### With solid shaft, Ø = 10 mm

Operating angle 10°

1 NO + 2 NC ⤴ B

**3SE5 212-0LU22-1DA0**

⤴ Positive opening according to IEC 60947-5-1, Appendix K, or positively driven actuator, usable in safety circuits.

# 3SE5, 3SE2 position switches

## For explosion protection (ATEX)

3SE5, metal enclosures  
Enclosure width 40 mm acc. to EN 50041/56 mm

### Selection and ordering data

#### Complete units

2 contacts · Degree of protection IP66 / IP67 · Cable entry M20 × 1.5

Version	Snap-action contacts	DT	Complete units
			<input type="checkbox"/>
			Order No.

#### Enclosure width 40 mm according to EN 50041

##### With M20 × 1.5 connecting thread

Snap-action contacts

1 NO + 1 NC

- Rounded plungers, high-grade steel, with 3 mm overtravel
- Roller plungers, high-grade steel roller, with 3 mm overtravel
- Roller levers, high-grade steel lever, plastic roller
- Angular roller levers, high-grade steel lever, plastic roller
- Twist levers, high-grade steel lever, plastic roller
- Fork levers, high-grade steel lever, plastic roller

⊕ B	3SE5 112-0CC02-1DA0
⊕ B	3SE5 112-0CD02-1DA0
⊕ B	3SE5 112-0CE03-1DA0
⊕ B	3SE5 112-0CF03-1DA0
⊕ B	3SE5 112-0CH11-1DA0
⊕ B	3SE5 112-0CT13-1DA0



Rounded plunger



Roller lever

#### Enclosure width 56 mm

##### With 3 x M20 x 1.5 connecting thread

Snap-action contacts

1 NO + 1 NC

- Rounded plungers, high-grade steel, with overtravel
- Roller plungers, high-grade steel roller
- Roller levers, high-grade steel lever, plastic roller
- Angular roller levers, high-grade steel lever, plastic roller
- Twist levers, high-grade steel lever, plastic roller

⊕ B	3SE5 122-0CC02-1DA0
⊕ B	3SE5 122-0CD02-1DA0
⊕ B	3SE5 122-0CE03-1DA0
⊕ B	3SE5 122-0CF03-1DA0
⊕ B	3SE5 122-0CH11-1DA0



Roller plunger



Twist lever

⊕ Positive opening according to IEC 60947-5-1, Appendix K

*Note: If the device you require is not available as a complete unit, see "Modular system" on the next page.*



# 3SE5, 3SE2 position switches

## For explosion protection (ATEX)

3SE5, metal enclosures  
Enclosure width 40 mm acc. to EN 50041/56 mm





### Modular system

2 or 3 contacts · Degree of protection IP66 / IP67 · Cable entry M20 × 1.5

Version	Contacts	DT	Modular system	
			Order No.	
<b>Basic switches • Enclosure width 40 mm acc. to EN 50041</b>				
 Basic switch	<b>With M20 × 1.5 connecting thread</b>			
	Slow-action contacts	1 NO + 1 NC	⊕ B	3SE5 112-0BA00-1DA0
	Snap-action contacts	1 NO + 1 NC	⊕ B	3SE5 112-0CA00-1DA0
	Slow-action contacts	1 NO + 2 NC	⊕ B	3SE5 112-0KA00-1DA0
	Snap-action contacts	1 NO + 2 NC	⊕ B	3SE5 112-0LA00-1DA0
	Slow-action contacts with make-before-break	1 NO + 2 NC	⊕ B	3SE5 112-0MA00-1DA0
Slow-action contacts	2 NO + 1 NC	⊕ B	3SE5 112-0PA00-1DA0	
<b>Basic switches • Enclosure width 56 mm</b>				
 Basic switch	<b>With 3 x M20 x 1.5 connecting thread</b>			
	Slow-action contacts	1 NO + 1 NC	⊕ B	3SE5 122-0BA00-1DA0
	Snap-action contacts	1 NO + 1 NC	⊕ B	3SE5 122-0CA00-1DA0
	Slow-action contacts	1 NO + 2 NC	⊕ B	3SE5 122-0KA00-1DA0
	Snap-action contacts	1 NO + 2 NC	⊕ B	3SE5 122-0LA00-1DA0
	Slow-action contacts with make-before-break	1 NO + 2 NC	⊕ B	3SE5 122-0MA00-1DA0
Slow-action contacts	2 NO + 1 NC	⊕ B	3SE5 122-0PA00-1DA0	
<b>Basic switches • Enclosure width 56 mm, XL</b>				
 Basic switch	<b>With 3 x M20 x 1.5 connecting thread</b>			
	Slow-action contacts	2 × (1 NO + 1 NC)	⊕ B	3SE5 162-0BA00-1DA0
	Snap-action contacts	2 × (1 NO + 1 NC)	⊕ B	3SE5 162-0CA00-1DA0
Slow-action contacts with make-before-break	2 × (1 NO + 2 NC)	⊕ B	3SE5 162-0DA00-1DA0	

⊕ Positive opening according to IEC 60947-5-1, Appendix K, or positively driven actuator, necessary in safety circuits.

*Note: For selection assistance, see page 2/8.*

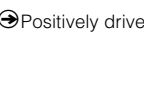

Version	Diameter	DT	Modular system
			Order No.
<b>Operating mechanisms</b>			
 Rounded plunger	<b>Plain plungers</b>		
	High-grade steel plungers		⊕ A 3SE5 000-0AB01
 Roller plunger	<b>Rounded plungers, type B, acc. to EN 50041</b>		
	High-grade steel plungers, with 3 mm overtravel		⊕ B 3SE5 000-0AC02
 Roller lever	<b>Roller plungers, type C acc. to EN 50041</b>		
	High-grade steel roller, with 3 mm overtravel	13	⊕ B 3SE5 000-0AD02
 Angular roller lever	<b>Roller levers</b>		
	Metal lever, plastic roller	22	⊕ A 3SE5 000-0AE01
	Metal lever, high-grade steel roller	22	⊕ B 3SE5 000-0AE02
	High-grade steel lever, plastic roller	22	⊕ B 3SE5 000-0AE03
 Angular roller lever	<b>Angular roller levers</b>		
	Metal lever, plastic roller	22	⊕ A 3SE5 000-0AF01
	Metal lever, high-grade steel roller	22	⊕ B 3SE5 000-0AF02
	High-grade steel lever, plastic roller	22	⊕ B 3SE5 000-0AF03
High-grade steel lever, high-grade steel roller	22	⊕ B 3SE5 000-0AF04	

⊕ Positively driven actuator, necessary in safety circuits.

# 3SE5, 3SE2 position switches

## For explosion protection (ATEX)

3SE5, metal enclosures  
Enclosure width 40 mm acc. to EN 50041/56 mm

Version	Diameter	DT	Modular system
	mm		Order No.
<b>Twist actuators</b>			
	<b>Twist actuators</b> , metal (without lever)		
Twist actuator	<ul style="list-style-type: none"> <li>For twist levers and rod actuators, switching right and/or left, adjustable</li> <li>- For enclosure width 40 and 56 mm</li> <li>For fork levers, latching</li> </ul>		
		⊕ A	<b>3SE5 000-0AH00</b>
		⊕ B	<b>3SE5 000-0AT10</b>
<b>Levers for twist actuators</b>			
<b>Twist levers 27 mm, offset, type A, acc. to EN 50041</b>			
	Metal lever, plastic roller	19	⊕ A <b>3SE5 000-0AA01</b>
Twist lever	Metal lever, high-grade steel roller	19	⊕ A <b>3SE5 000-0AA02</b>
	Metal lever, roller with ball bearing	19	⊕ B <b>3SE5 000-0AA03</b>
	Metal lever, 2 plastic rollers	19	⊕ B <b>3SE5 000-0AA04</b>
	Metal lever, plastic roller	30	⊕ B <b>3SE5 000-0AA05</b>
	Metal lever, rubber roller	50	⊕ B <b>3SE5 000-0AA08</b>
	High-grade steel lever, plastic roller	19	⊕ B <b>3SE5 000-0AA11</b>
	High-grade steel lever, high-grade steel roller	19	⊕ B <b>3SE5 000-0AA12</b>
<b>Twist levers 35 mm, offset</b>			
	Metal lever, plastic roller	19	⊕ B <b>3SE5 000-0AA15</b>
<b>Twist levers 30 mm, straight<sup>1)</sup></b>			
	Metal lever, plastic roller	19	⊕ B <b>3SE5 000-0AA24</b>
	Metal lever, plastic roller	30	⊕ B <b>3SE5 000-0AA26</b>
<b>Twist levers, adjustable length, with grid hole</b>			
	Metal lever, plastic roller	19	⊕ B <b>3SE5 000-0AA60</b>
	Metal lever, high-grade steel roller	19	⊕ B <b>3SE5 000-0AA61</b>
	Metal lever, rubber roller	50	⊕ B <b>3SE5 000-0AA68</b>
	High-grade steel lever, plastic roller	19	⊕ B <b>3SE5 000-0AA62</b>
	High-grade steel lever, high-grade steel roller	19	⊕ B <b>3SE5 000-0AA63</b>
<b>Fork levers (for switches with snap-action contacts only)</b>			
	2 metal levers, 2 plastic rollers	19	⊕ B <b>3SE5 000-0AT01</b>
Fork lever	2 metal levers, 2 high-grade steel rollers	19	⊕ B <b>3SE5 000-0AT02</b>
	2 high-grade steel levers, 2 plastic rollers	19	⊕ B <b>3SE5 000-0AT03</b>
	2 high-grade steel levers, 2 high-grade steel rollers	19	⊕ B <b>3SE5 000-0AT04</b>

⊕ Positively driven actuator, necessary in safety circuits.

<sup>1)</sup> Can be clinch mounted (turned through 180°, rear of lever).



# 3SE5, 3SE2 position switches

## For explosion protection (ATEX)

3SE5, metal enclosures  
Enclosure width 40 mm acc. to EN 50041/56 mm

### Position switches with separate actuator · Complete units

5 directions of approach · 3 contacts · Degree of protection IP66 / IP67 · Cable entry M20 × 1.5



Version <sup>1)</sup>	Contacts	DT	Complete units
			Order No. <input type="checkbox"/>
<b>Enclosure width 40 mm according to EN 50041</b>			
	<b>With M20 × 1.5 connecting thread</b> Slow-action contacts	1 NO + 2 NC ⤴ B	<b>3SE5 112-0QV10-1DA0</b>
With separate actuator			
<b>Enclosure width 56 mm</b>			
	<b>With 3 x M20 x 1.5 connecting thread</b> Slow-action contacts	1 NO + 2 NC ⤴ B	<b>3SE5 122-0QV10-1DA0</b>
With separate actuator			

⤴ Positive opening according to IEC 60947-5-1, Appendix K.

<sup>1)</sup> Supplied without actuator. Please order separately (see page 2/51).

### Hinge switches · Complete units

3 contacts · Degree of protection IP66 / IP67 · Cable entry M20 × 1.5

Version	Snap-action contacts	DT	Complete units
			Order No. <input type="checkbox"/>
<b>Enclosure width 40 mm according to EN 50041</b>			
	<b>With hollow shaft, Ø 8/12 mm</b> Operating angle 10°	1 NO + 2 NC ⤴ B	<b>3SE5 112-0LU21-1DA0</b>
With hollow shaft			
	<b>With solid shaft, Ø = 10 mm</b> Operating angle 10°	1 NO + 2 NC ⤴ B	<b>3SE5 112-0LU22-1DA0</b>
With solid shaft			

⤴ Positive opening according to IEC 60947-5-1, Appendix K, or positively driven actuator, usable in safety circuits.

# 3SF1 AS-Interface position switches

## General data

### Overview

The 3SF1 position switches with safety-oriented communication can be directly connected using the AS-Interface bus system. The safety functions no longer have to be conventionally wired up.

With the 3SF1 position switches the ASIsafe electronics are integrated in the switch enclosure.



Examples of selection options in the modular system

### Modular system

The position switches of the 3SF1 1.4 and 3SF1 2.4 series are constructed from a modular system comprising different versions of the basic switch and an actuator which must be ordered separately. Thanks to the modular design of the switch the end user can select the right solution for his application from numerous versions and install it himself in a very short time.

### Design

The 3SF1 switches are available in four different enclosure sizes:

- Plastic and metal enclosures according to EN 50047, 31 mm wide, with M12 connector socket
- Molded-plastic and metal enclosures according to EN 50041, 40 mm wide, with M12 connector socket
- Molded-plastic enclosures, 50 mm wide, with M12 plug and M12 socket
- Metal enclosures, 56 mm wide, with M12 plug and M12 socket

### Display

The switches have a status display with three LEDs:

- LED 1 (yellow): F-IN1
- LED 2 (yellow): F-IN2
- LED 3 (green/red): AS-I/FAULT

### Connection

Connection to the AS-Interface is by means of a 4-pole M12 connector socket (plastic version) connected to the yellow AS-Interface bus cable.

The wide enclosures (50 or 56 mm) also have an M12 socket for connecting a second position switch. Category 4 according to EN 954-1 is thus achieved.

### Benefits

The new generation of 3SF1 position switches offers:

- ASIsafe Electronics integrated in the enclosure, with low power consumption < 60 mA
- An extensive range of actuators
- Status display with three LEDs

### Application

With the standard position switches, mechanical positions of moved machine parts are converted into electrical signals. Through their modular and uniform design and large number of variants, the devices can meet practically all requirements in industry.

Devices are available with enclosure versions to suit the particular ambient conditions. Different control tasks can be performed with the best contact blocks suited for the particular purpose. And many different actuator variants are available to match the mechanical configuration of the moved machined parts. Dimensions, fixing points and characteristics are largely in accordance with the EN 50041 or EN 50047 standards.

The devices are suitable for use in any climate.

### Standards

The switches comply with the standards IEC 60947-1 (Low-Voltage Switchgear and Controlgear, General) and IEC 60947-5-1 (Electromechanical Control Circuit Devices).

The mechanical design of the switch corresponds to the requirements of the failsafe principle according to EN 1088.

### Approvals

AS-Interface according to EN 50295 and IEC 62026-2.

With a 3SF1 position switch it is possible to achieve category 2 according to ISO 13849-1 (EN 954-1) or SIL 1 according to IEC 61508.

Categories 3 or 4 according to ISO 13849-1 (EN 954-1) or SIL 2 or 3 according to IEC 61508 can be achieved by using a second 3SE5 position switch.

The 3SF1 position switches are approved according to UL 508, UL 50 and UL 746-C.



## More information

Type	3SF1 1.., 3SF1 2..	
<b>General data</b>		
<b>Standards</b>	IEC 60947-5-1, EN 60947-5-1, EN 1088	
<b>According to AS-Interface specification</b>		
• I/O configuration / ID configuration		7/B
• ID1 code/ID2 code (Hex)		F/F
• Power consumption, overall	mA	≤ 60
<b>Inputs</b>		
• Low signal range	Contact open	
• High signal range	Contact closed, $I_{in}$ dynamic ( $I_{peak} \geq 5$ mA)	
<b>Status display</b>	Green/red dual LED	
<b>Rated impulse withstand voltage <math>U_{imp}</math></b>	kV	0.6
<b>EMC resistance</b>		
• EN 60000-1-2	kV	4
• EN 60000-4-3	V/m	10
• EN 60000-4-4 (A/B)	kV	1 / 2
<b>Mechanical endurance</b>		
• Basic switches	15 × 10 <sup>6</sup> operating cycles	
• With separate actuator, 3SF1 ...-..V..	1 × 10 <sup>6</sup> operating cycles	
<b>PFH value</b>		
Probability of failure upon request of the safety function, with 1 actuation per hour and B10 = 5 × 10 <sup>6</sup>		
• Basic switches	4 × 10 <sup>-9</sup> 1/h	
• With separate actuator, 3SF1 ...-..V..	2 × 10 <sup>-9</sup> 1/h	
• Hinge switch, 3SF1 ...-..U..	2 × 10 <sup>-9</sup> 1/h	
<b>Shock resistance</b> acc. to IEC 60068-2-27	30 g/11 ms	

Type	3SF1 234	3SF1 134	3SF1 244	3SF1 214	3SF1 114	3SF1 124
<b>Enclosures</b>						
<b>Enclosures</b>						
• Material	Ultradim A3X2G7			Zinc diecasting GD Zn Al4 Cu1		
• Width	mm	31	40	50	31	40
• Dimensions acc. to EN		EN 50047	EN 50041	--	EN 50047	EN 50041
<b>Degree of protection</b> acc. to EN 60529		IP65	IP66 / IP67 <sup>1)</sup>			
<b>Ambient temperature</b>						
• During operation	°C	-25 ... +60				
• Storage, transport	°C	-40 ... +80				
<b>Mounting position</b>	Any					

<sup>1)</sup> For twist actuators with spring rod and rod actuators: IP65/IP67.

## Connector assignment

## M12 connector socket, 4-pole

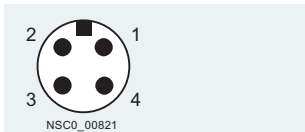

- 1 ASi +
- 2 Not assigned
- 3 ASi -
- 4 Not assigned

## M12 socket, 4-pole

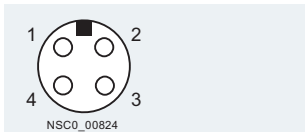

- 1 Channel 2
- 2 Not assigned
- 3 Channel 2
- 4 Not assigned

## LEDs

## Status display (operating state)

LEDs	No voltage on AS-Interface chip	Communication OK	Communication failed	Slave has address "0"
ASi/Fault (GN/RD)				

## Safe inputs

LEDs	Not actuated	Actuated		
F-IN1 (YE)				
F-IN2 (YE)				

# 3SF1 AS-Interface position switches

Molded-plastic enclosures  
Enclosure width 31 mm acc. to EN 50047/50 mm

## Selection and ordering data

### Modular system

For the ASIsafe version of the position switch, the basic switch and actuator must be ordered separately.

1 or 2 contacts · 3 LEDs · Degree of protection IP65 (31 mm) or IP66 / IP67 (50 mm) · M12 connector socket

Version	Contacts	LEDs	DT	Modular system
				<input type="checkbox"/>
				Order No.

### Basic switches (with rounded plunger<sup>1)</sup>) · Enclosure width 31 mm according to EN 50047



#### With teflon plunger

With M12 connector socket, 4-pole, channel 1 on NC contact, channel 2 on NC contact

Slow-action contacts	2 NC	24 V DC	⊕ B	<b>3SF1 234-1KC05-1BA1</b>
Snap-action contacts	2 NC	24 V DC	⊕ B	<b>3SF1 234-1LC05-1BA1</b>

ASIsafe basic switch

### Basic switches (with rounded plunger<sup>1)</sup>) · Enclosure width 50 mm



#### With teflon plunger

With M12 connector socket, 4-pole, channel 1 on NC contact, channel 2 on M12 socket, right

Slow-action contacts	1 NC	24 V DC	⊕ B	<b>3SF1 244-1KC05-1BA2</b>
Snap-action contacts	1 NC	24 V DC	⊕ B	<b>3SF1 244-1LC05-1BA2</b>









ASIsafe basic switch

⊕ Positive opening according to IEC 60947-5-1, Appendix K, or positively driven actuator, usable in safety circuits.

<sup>1)</sup> On enclosure widths 31 mm and 50 mm the basic switch is a complete unit with rounded plunger.

*Note: For selection assistance, see page 2/8.*

Molded-plastic enclosures  
Enclosure width 31 mm acc. to EN 50047/50 mm

Version	Roller diameter	DT	Modular system	
	mm		Order No.	
<b>Operating mechanisms</b>				
 Roller plunger	<b>Roller plungers, type C acc. to EN 50047</b>			
	Plastic rollers	10	⊕ A	<b>3SE5 000-0AD03</b>
	High-grade steel rollers	10	⊕ B	<b>3SE5 000-0AD04</b>
 With central fixing	<b>Roller plungers with central fixing</b>			
	Plastic rollers	10	⊕ B	<b>3SE5 000-0AD10</b>
	High-grade steel rollers	10	⊕ B	<b>3SE5 000-0AD11</b>
 Roller lever	<b>Roller levers, type E acc. to EN 50047</b>			
	Metal lever, plastic roller	13	⊕ A	<b>3SE5 000-0AE10</b>
	Metal lever, high-grade steel roller	13	⊕ B	<b>3SE5 000-0AE11</b>
	High-grade steel lever, plastic roller	13	⊕ B	<b>3SE5 000-0AE12</b>
	High-grade steel lever, high-grade steel roller	13	⊕ B	<b>3SE5 000-0AE13</b>
 Angular roller lever	<b>Angular roller levers</b>			
	Metal lever, plastic roller	13	⊕ A	<b>3SE5 000-0AF10</b>
	Metal lever, high-grade steel roller	13	⊕ B	<b>3SE5 000-0AF11</b>
	High-grade steel lever, plastic roller	13	⊕ A	<b>3SE5 000-0AF12</b>
	High-grade steel lever, high-grade steel roller	13	⊕ B	<b>3SE5 000-0AF13</b>
<b>Twist actuators with lever</b>				
 Twist actuator	<b>Twist actuators, plastic (without lever)</b>			
	Switching right or left, adjustable		⊕ A	<b>3SE5 000-0AK00</b>
<b>Levers for twist actuators</b>				
 Twist lever	<b>Twist levers, type A acc. to EN 50047</b>			
	Metal lever, plastic roller	19	⊕ A	<b>3SE5 000-0AA21</b>
	Metal lever, high-grade steel roller	19	⊕ B	<b>3SE5 000-0AA22</b>
	Metal lever, roller with ball bearing	19	⊕ B	<b>3SE5 000-0AA23</b>
	Metal lever, plastic roller	30	⊕ B	<b>3SE5 000-0AA25</b>
	High-grade steel lever, plastic roller	19	⊕ B	<b>3SE5 000-0AA31</b>
	High-grade steel lever, high-grade steel roller	19	⊕ B	<b>3SE5 000-0AA32</b>
 Twist lever, adjustable length	<b>Twist levers 30 mm, straight<sup>1)</sup></b>			
	Metal lever, plastic roller	19	⊕ B	<b>3SE5 000-0AA24</b>
	Metal lever, plastic roller	30	⊕ B	<b>3SE5 000-0AA26</b>
 Twist lever, adjustable length	<b>Twist levers, adjustable length, with grid hole</b>			
	Metal lever, plastic roller	19	⊕ B	<b>3SE5 000-0AA60</b>
	Metal lever, high-grade steel roller	19	⊕ B	<b>3SE5 000-0AA61</b>
	Metal lever, plastic roller	50	⊕ B	<b>3SE5 000-0AA67</b>
	Metal lever, rubber roller	50	⊕ B	<b>3SE5 000-0AA68</b>
	High-grade steel lever, plastic roller	19	⊕ B	<b>3SE5 000-0AA62</b>
	High-grade steel lever, high-grade steel roller	19	⊕ B	<b>3SE5 000-0AA63</b>

⊕ Positively driven actuator, usable in safety circuits.

<sup>1)</sup> Can be clinch mounted (turned through 180°, rear of lever).

# 3SF1 AS-Interface position switches

**Metal enclosures**  
Enclosure width 31 mm according to EN 50047

## Selection and ordering data

### Modular system

For the ASIsafe version of the position switch, the basic switch and actuator must be ordered separately.

2 contacts · 3 LEDs · Degree of protection IP66 / IP67 · M12 connector socket

Version	Contacts	LEDs	DT	Modular system
				Order No. <input type="checkbox"/>

### Basic switches (with rounded plunger<sup>1)</sup>) · Enclosure width 31 mm according to EN 50047



#### With plunger

With M12 connector socket, 4-pole, channel 1 on NC contact, channel 2 on NC contact

Slow-action contacts	2 NC	24 V DC	⊕ B	<b>3SF1 214-1KC05-1BA1</b>
Snap-action contacts	2 NC	24 V DC	⊕ B	<b>3SF1 214-1LC05-1BA1</b>









ASIsafe basic switch

⊕ Positive opening according to IEC 60947-5-1, Appendix K, or positively driven actuator, usable in safety circuits.

<sup>1)</sup> On enclosure width 31 mm the basic switch is a complete unit with rounded plunger.

*Note: For selection assistance, see page 2/8.*

**Metal enclosures**  
Enclosure width 31 mm according to EN 50047

Version	Plunger or roller diameter	DT	Modular system
	mm		Order No.
<b>Operating mechanisms</b>			
	<b>Plain plungers</b> High-grade steel plungers	10	⊕ A 3SE5 000-0AB01
Plain plunger			
	<b>Roller plungers, type C acc. to EN 50047</b> Plastic rollers High-grade steel rollers	10 10	⊕ A 3SE5 000-0AD03 ⊕ B 3SE5 000-0AD04
Roller plunger			
	<b>Roller plungers with central fixing</b> Plastic rollers High-grade steel rollers	10 10	⊕ B 3SE5 000-0AD10 ⊕ B 3SE5 000-0AD11
With central fixing			
	<b>Roller levers, type E acc. to EN 50047</b> Metal lever, plastic roller Metal lever, high-grade steel roller High-grade steel lever, plastic roller High-grade steel lever, high-grade steel roller	13 13 13 13	⊕ A 3SE5 000-0AE10 ⊕ B 3SE5 000-0AE11 ⊕ B 3SE5 000-0AE12 ⊕ B 3SE5 000-0AE13
Roller lever			
	<b>Angular roller levers</b> Metal lever, plastic roller Metal lever, high-grade steel roller High-grade steel lever, plastic roller High-grade steel lever, high-grade steel roller	13 13 13 13	⊕ A 3SE5 000-0AF10 ⊕ B 3SE5 000-0AF11 ⊕ A 3SE5 000-0AF12 ⊕ B 3SE5 000-0AF13
Angular roller lever			
<b>Twist actuators with lever</b>			
	<b>Twist actuators, plastic (without lever)</b> Switching right or left, adjustable		⊕ A 3SE5 000-0AK00
Twist actuator			
<b>Levers for twist actuators</b>			
	<b>Twist levers, type A acc. to EN 50047</b> Metal lever, plastic roller Metal lever, high-grade steel roller Metal lever, roller with ball bearing Metal lever, plastic roller High-grade steel lever, plastic roller High-grade steel lever, high-grade steel roller	19 19 19 30 19 19	⊕ A 3SE5 000-0AA21 ⊕ B 3SE5 000-0AA22 ⊕ B 3SE5 000-0AA23 ⊕ B 3SE5 000-0AA25 ⊕ B 3SE5 000-0AA31 ⊕ B 3SE5 000-0AA32
Twist lever			
	<b>Twist levers 30 mm, straight<sup>1)</sup></b> Metal lever, plastic roller Metal lever, plastic roller	19 30	⊕ B 3SE5 000-0AA24 ⊕ B 3SE5 000-0AA26
Twist lever, adjustable length			
	<b>Twist levers, adjustable length, with grid hole</b> Metal lever, plastic roller Metal lever, high-grade steel roller Metal lever, plastic roller Metal lever, rubber roller High-grade steel lever, plastic roller High-grade steel lever, high-grade steel roller	19 19 50 50 19 19	⊕ B 3SE5 000-0AA60 ⊕ B 3SE5 000-0AA61 ⊕ B 3SE5 000-0AA67 ⊕ B 3SE5 000-0AA68 ⊕ B 3SE5 000-0AA62 ⊕ B 3SE5 000-0AA63
Twist lever, adjustable length			

⊕ Positively driven actuator, usable in safety circuits.

<sup>1)</sup> Can be clinch mounted (turned through 180°, rear of lever).

# 3SF1 AS-Interface position switches

## Metal enclosures

Enclosure width 40 mm acc. to EN 50041/56 mm

### Selection and ordering data

#### Modular system

For the ASIsafe version of the position switch, the basic switch and actuator must be ordered separately.

1 or 2 contacts · 3 LEDs · Degree of protection IP66 / IP67 · M12 connector socket

Version	Contacts	LEDs	DT	Modular system
				Order No.

#### Basic switches · Enclosure width 40 mm according to EN 50041



ASIsafe basic switch

With M12 connector socket, 4-pole,  
channel 1 on NC contact,  
channel 2 on NC contact

Slow-action contacts	2 NC	24 V DC	⊕	B	<b>3SF1 114-1KA00-1BA1</b>
Snap-action contacts	2 NC	24 V DC	⊕	B	<b>3SF1 114-1LA00-1BA1</b>

#### Basic switches · Enclosure width 56 mm



ASIsafe basic switch

With M12 connector socket, 4-pole,  
channel 1 on NC contact,  
channel 2 on M12 socket, right

Slow-action contacts	1 NC	24 V DC	⊕	B	<b>3SF1 124-1KA00-1BA2</b>
Snap-action contacts	1 NC	24 V DC	⊕	B	<b>3SF1 124-1LA00-1BA2</b>

⊕ Positive opening according to IEC 60947-5-1, Appendix K, or positively driven actuator, usable in safety circuits.

*Note: For selection assistance, see page 2/8.*

Version	Plunger or roller diameter	DT	Modular system
			Order No.

#### Operating mechanisms



Plain plunger

##### Plain plungers

High-grade steel plungers	10	⊕	A	<b>3SE5 000-0AB01</b>
---------------------------	----	---	---	-----------------------



Rounded plunger

##### Rounded plungers, type B, acc. to EN 50041

High-grade steel plungers, with 3 mm overtravel	10	⊕	B	<b>3SE5 000-0AC02</b>
---	----	---	---	-----------------------









Roller plunger

##### Roller plungers, type C acc. to EN 50041

High-grade steel roller, with 3 mm overtravel	13	⊕	B	<b>3SE5 000-0AD02</b>
---	----	---	---	-----------------------

⊕ Positively driven actuator, usable in safety circuits.

**Metal enclosures**  
Enclosure width 40 mm acc. to EN 50041/56 mm

Version	Roller diameter	DT	Modular system	☒
	mm		Order No.	
<b>Operating mechanisms</b>				
	<b>Roller levers</b>			
	Metal lever, plastic roller	22	⊕ A	<b>3SE5 000-0AE01</b>
	Metal lever, high-grade steel roller	22	⊕ B	<b>3SE5 000-0AE02</b>
	High-grade steel lever, plastic roller	22	⊕ B	<b>3SE5 000-0AE03</b>
	High-grade steel lever, high-grade steel roller	22	⊕ B	<b>3SE5 000-0AE04</b>
	<b>Angular roller levers</b>			
	Metal lever, plastic roller	22	⊕ A	<b>3SE5 000-0AF01</b>
	Metal lever, high-grade steel roller	22	⊕ B	<b>3SE5 000-0AF02</b>
	High-grade steel lever, plastic roller	22	⊕ B	<b>3SE5 000-0AF03</b>
	High-grade steel lever, high-grade steel roller	22	⊕ B	<b>3SE5 000-0AF04</b>
<b>Twist actuators with lever</b>				
	<b>Twist actuators, metal (without lever)</b>			
	<ul style="list-style-type: none"> <li>• For twist levers, switching right or left, adjustable</li> <li>- For enclosure width 40 and 56 mm</li> </ul>		⊕ A	<b>3SE5 000-0AH00</b>
	<ul style="list-style-type: none"> <li>• For fork levers, latching</li> </ul>		⊕ B	<b>3SE5 000-0AT10</b>
<b>Levers for twist actuators</b>				
	<b>Twist levers 27 mm, offset, type A, acc. to EN 50041</b>			
	Metal lever, plastic roller	19	⊕ A	<b>3SE5 000-0AA01</b>
	Metal lever, high-grade steel roller	19	⊕ A	<b>3SE5 000-0AA02</b>
	Metal lever, roller with ball bearing	19	⊕ B	<b>3SE5 000-0AA03</b>
	Metal lever, 2 plastic rollers	19	⊕ B	<b>3SE5 000-0AA04</b>
	Metal lever, plastic roller	30	⊕ B	<b>3SE5 000-0AA05</b>
	Metal lever, plastic roller	50	⊕ B	<b>3SE5 000-0AA07</b>
	Metal levers, rubber roller	50	⊕ B	<b>3SE5 000-0AA08</b>
	High-grade steel lever, plastic roller	19	⊕ B	<b>3SE5 000-0AA11</b>
	High-grade steel lever, high-grade steel roller	19	⊕ B	<b>3SE5 000-0AA12</b>
	<b>Twist levers 35 mm, offset</b>			
	Metal lever, plastic roller	19	⊕ B	<b>3SE5 000-0AA15</b>
	<b>Twist levers 30 mm, straight<sup>1)</sup></b>			
	Metal lever, plastic roller	19	⊕ B	<b>3SE5 000-0AA24</b>
	Metal lever, plastic roller	30	⊕ B	<b>3SE5 000-0AA26</b>
	<b>Twist levers, adjustable length, with grid hole</b>			
	Metal lever, plastic roller	19	⊕ B	<b>3SE5 000-0AA60</b>
	Metal lever, high-grade steel roller	19	⊕ B	<b>3SE5 000-0AA61</b>
	Metal lever, plastic roller	50	⊕ B	<b>3SE5 000-0AA67</b>
	Metal lever, rubber roller	50	⊕ B	<b>3SE5 000-0AA68</b>
	High-grade steel lever, plastic roller	19	⊕ B	<b>3SE5 000-0AA62</b>
	High-grade steel lever, high-grade steel roller	19	⊕ B	<b>3SE5 000-0AA63</b>
<b>Fork levers (for switches with snap-action contacts only)</b>				
	Metal lever, 2 plastic rollers	19	⊕ B	<b>3SE5 000-0AT01</b>
	Metal lever, 2 high-grade steel rollers	19	⊕ B	<b>3SE5 000-0AT02</b>
	High-grade steel lever, 2 plastic rollers	19	⊕ B	<b>3SE5 000-0AT03</b>
	High-grade steel lever, 2 high-grade steel rollers	19	⊕ B	<b>3SE5 000-0AT04</b>

⊕ Positively driven actuator, usable in safety circuits.

<sup>1)</sup> Can be clinch mounted (turned through 180°, rear of lever).

# 3SF1 AS-Interface position switches

## With separate actuator

### General data

#### Overview

The 3SF1 position switches with safety-oriented communication can be directly connected using the AS-Interface bus system. The safety functions no longer have to be conventionally wired up.

With the 3SF1 position switches the ASIsafe electronics are integrated in the switch enclosure.



3SF1 position switches with head for separate actuator and with integrated ASIsafe Electronics

3SF1 position switches with separate actuator have the same enclosures as the standard switches.

#### Operation

The actuator head is included in the scope of supply. For actuation from four directions it can be adjusted through  $4 \times 90^\circ$ . The switches can also be approached from above.

The actuators are not included in the scope of supply of the position switch and must be ordered separately from a choice of six versions to suit the application.

The actuator is encoded. Simple overruling by hand or auxiliary devices is impossible.

A high-grade steel blocking insert for attaching up to eight padlocks is available for even more safety.

A rubber cap to protect the metal enclosure from contamination is available for operation in dusty environments.

#### Display

The switches have a status display with three LEDs:

- LED 1 (yellow): F-IN1
- LED 2 (yellow): F-IN2
- LED 3 (green/red): AS-I/FAULT

#### Connection

Connection to the AS-Interface is by means of a 4-pole M12 connector socket (plastic version) connected to the yellow AS-Interface bus cable.

The wide enclosures (50 or 56 mm) also have an M12 socket for connecting a second position switch. Category 4 according to EN 954-1 is thus achieved.

#### Benefits

The new generation of 3SF1 position switches with separate actuator offers:

- ASIsafe Electronics integrated in the enclosure, with low power consumption  $< 60 \text{ mA}$
- An extensive range of actuators
- Status display with three LEDs

#### Application

Position switches with separate actuator are used where the position of doors, covers or protective grills must be monitored for safety reasons.

The position switch can only be operated with the matching coded actuator. Simple overruling by hand or auxiliary devices is impossible.

Devices are available with enclosure versions to suit the particular ambient conditions. Different control tasks can be performed with the best contact blocks suited for the particular purpose. Dimensions, fixing points of the enclosure are in accordance with EN 50041 or EN 50047 standards.

The devices are suitable for use in any climate.

#### Standards

The switches comply with the standards IEC 60947-1 (Low-Voltage Switchgear and Controlgear, General) and IEC 60947-5-1 (Electromechanical Control Circuit Devices).

The mechanical design of the switch corresponds to the requirements of the failsafe principle according to EN 1088.

#### Approvals

AS-Interface according to EN 50295 and IEC 62026-2.

With a 3SF1 position switch it is possible to achieve Category 3 according to ISO 13849-1 (EN 954-1) or SIL 2 according to IEC 61508.

Category 4 according to ISO 13849-1 (EN 954-1) or SIL 3 according to IEC 61508 can be achieved by using a second 3SE5 position switch.

The 3SF1 position switches are approved according to UL 508, UL 50 and UL 746-C.



# 3SF1 AS-Interface position switches



## With separate actuator

Molded-plastic enclosures  
Enclosure width 31 mm / 50 mm

### Overview

- Contacts: 1 or 2 slow-action contacts
- Status display with 3 LEDs 24 V DC;  
1: F-IN1, 2: F-IN2, 3: AS-I/FAULT
- Degree of protection IP65 (31 mm) or IP66 / IP67 (50 mm)

### Selection and ordering data

Version <sup>1)</sup>	Contacts	DT	Complete units
			Order No. <input type="text"/>
<b>Enclosure width 31 mm according to EN 50047</b>			
	<b>5 directions of approach</b> With M12 connector socket, 4-pole; channel 1 on NC contact, channel 2 on NC contact Slow-action contacts	2 NC	⊕ B <b>3SF1 234-1QV40-1BA1</b>
<b>Enclosure width 50 mm</b>			
	<b>5 directions of approach</b> With M12 connector socket, 4-pole; channel 1 on NC, channel 2 on M12 socket, right Slow-action contacts	1 NC	⊕ B <b>3SF1 244-1QV40-1BA2</b>

⊕ Positive opening according to IEC 60947-5-1, Appendix K.

<sup>1)</sup> Supplied without actuator. Please order separately.

# 3SF1 AS-Interface position switches

## With separate actuator



Metal enclosures

Enclosure width 31 mm / 40 mm / 56 mm

### Overview

- Contacts: 1 or 2 slow-action contacts
- Status display with 3 LEDs 24 V DC;  
1: F-IN1, 2: F-IN2, 3: AS-I/FAULT
- Degree of protection IP66 / IP67

### Selection and ordering data

Version <sup>1)</sup>	Contacts	DT	Complete units
			Order No.
<b>Enclosure width 31 mm according to EN 50047</b>			
	<b>5 directions of approach</b> With M12 connector socket, 4-pole; channel 1 on NC contact, channel 2 on NC contact Slow-action contacts	2 NC	⊕ B <b>3SF1 214-1QV40-1BA1</b>
<b>Enclosure width 40 mm according to EN 50041</b>			
	<b>5 directions of approach</b> With M12 connector socket, 4-pole; channel 1 on NC contact, channel 2 on NC contact Slow-action contacts	2 NC	⊕ B <b>3SF1 114-1QV10-1BA1</b>
<b>Enclosure width 56 mm</b>			
	<b>5 directions of approach</b> With M12 connector socket, 4-pole; channel 1 on NC, channel 2 on M12 socket, right Slow-action contacts	1 NC	⊕ B <b>3SF1 124-1QV10-1BA2</b>

⊕ Positive opening according to IEC 60947-5-1, Appendix K.









<sup>1)</sup> Supplied without actuator. Please order separately.

# 3SF1 AS-Interface position switches

## With separate actuator

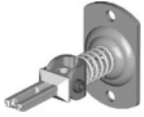
Accessories

## Overview

Version	DT	Order No.
<b>Actuators</b>		
 3SE5 000-0AV01	<b>Standard actuators</b> <ul style="list-style-type: none"> <li>Length 75.6 mm</li> </ul>	▶ <b>3SE5 000-0AV01</b>
 3SE5 000-0AV02	<ul style="list-style-type: none"> <li>With vertical fixing, length 53 mm</li> </ul>	A <b>3SE5 000-0AV02</b>
 3SE5 000-0AV03	<ul style="list-style-type: none"> <li>With transverse fixing, length 47 mm</li> </ul>	A <b>3SE5 000-0AV03</b>
 3SE5 000-0AV04	<b>Radius actuators,</b> length 51 mm <ul style="list-style-type: none"> <li>Direction of approach from the left</li> </ul>	A <b>3SE5 000-0AV04</b>
 3SE5 000-0AV6	<ul style="list-style-type: none"> <li>Direction of approach from the right</li> </ul>	A <b>3SE5 000-0AV06</b>
 3SE5 000-0AV05	<b>Universal radius actuators,</b> length 77 mm	A <b>3SE5 000-0AV05</b>
 3SE5 000-0AV07	<b>Universal radius actuators, heavy-duty</b> <ul style="list-style-type: none"> <li>Length 67 mm</li> <li>Length 77 mm</li> </ul>	A <b>3SE5 000-0AV07-1AK2</b> A <b>3SE5 000-0AV07</b>
<b>Optional accessories</b>		
 3SE5 000-0AV08-1AA2	<b>Protective caps</b> made of black rubber for the actuator head, B to protect the actuator openings from contamination (Only for enclosure width 40 or 56 mm)	<b>3SE5 000-0AV08-1AA2</b>
 3SE5 000-0AV08-1AA3	<b>Blocking inserts,</b> high-grade steel, for actuator head, for up to 8 padlocks	C <b>3SE5 000-0AV08-1AA3</b>

2

# 3SF1 AS-Interface position switches

## With interlocking

### General data

#### Overview

The 3SF1 position switches with safety-oriented communication can be directly connected using the AS-Interface bus system. The safety functions no longer have to be conventionally wired up.

With the 3SF1 position switches the ASIsafe electronics are integrated in the switch enclosure.



3SF1 position switch with interlocking and with integrated ASIsafe electronics

#### Operation

The actuator head is included in the scope of supply. For actuation from four directions it can be adjusted through  $4 \times 90^\circ$ . The switches can also be approached from above.

The actuators are not included in the scope of supply of the position switch and must be ordered separately from a choice of six versions to suit the application.

The actuator is encoded. Simple overruling by hand or auxiliary devices is impossible.

A high-grade steel blocking insert for attaching up to eight padlocks is available for even more safety.

A rubber cap to protect the enclosure from contamination is available for operation in dusty environments.

#### Interlocking

There are two versions for locking the actuator:

- Spring-actuated lock (closed-circuit principle) with various release mechanisms
- Solenoid lock (open-circuit principle)

For more explanations see page 2/54.

#### Display

The switches have a status display with four LEDs:

- LED 1 (green): AS-i
- LED 2 (red): FAULT
- LED 3 (yellow): F-IN1
- LED 4 (yellow): F-IN2

#### Connection

Connection to the AS-Interface is by means of a 4-pole M12 connector socket (plastic version) connected to the yellow AS-Interface bus cable (no additional supply of auxiliary power is required thanks to the low current consumption of the solenoid of max. 170 mA).

#### Benefits

The new generation of 3SF1 3 position switches with solenoid interlocking offers:

- More safety through higher locking forces:
  - 1300 N for the plastic version
  - 2600 N for the metal version
- Various release mechanisms: lock release, escape release and emergency release
- ASIsafe Electronics integrated in the enclosure; connected through 4-pole M12 connector socket
- Current consumption of the solenoid max. 170 mA
- Two contact blocks as standard equipment, hence fewer versions needed
- Same dimensions for all enclosure variants: Plastic, metal
- An extensive range of actuators
- Status display with four LEDs

#### Application

The position switches with interlocking are exceptional safety-related devices which prevent an unforeseen or intentional opening of protective doors, protective grills or other covers as long as a dangerous situation is present (i.e. follow-on motion of the switched off machine).

The safety position switches with interlocking have the following functions:

- Enabling the machine or process with closed and locked protective device
- Locking the machine or process with opened protective device
- Position monitoring of the protective device and solenoid interlocking

#### Standards

The switches comply with the standards IEC 60947-1 (Low-Voltage Switchgear and Controlgear, General) and IEC 60947-5-1 (Electromechanical Control Circuit Devices).

The mechanical design of the switch corresponds to the requirements of the failsafe principle according to EN 1088.

#### Approvals

AS-Interface according to EN 50295 and IEC 62026-2.

The switches are approved for use with locking devices according to EN 1088 and EN 292, Parts 1 and 2.

3SE5 3 position switches with interlocking bear the VDE test mark.

With a 3SF1 3 position switch with interlocking it is possible to achieve category 3 according to ISO 13849-1 (EN 954-1) or SIL 2 according to IEC 61508.

Category 4 according to ISO 13849-1 (EN 954-1) or SIL 3 according to IEC 61508 can be achieved by using a second 3SE5 position switch.

The 3SF1 position switches are approved according to UL 508, UL 50 and UL 746-C.

## Overview

## 5 directions of approach · Degree of protection IP66 / IP67

- Slow-action contacts:
  - Version -1BA1: ASIsafe channel 1 on 1 NC contact from the actuator and channel 2 on 1 NC contact from the solenoid<sup>1)</sup>
  - Version -1BA3: ASIsafe channel 1 on the first NC contact from the actuator and channel 2 on the second NC contact from the actuator
  - Version -1BA4: ASIsafe channel 1 on 2 NC contacts from the actuator and channel 2 on 1 NC contact from the solenoid A discrepancy between the two contacts of the actuator will be evaluated already in the switch.
- Solenoid: Rated operational voltage 24 V DC
- Locking force 1300 N (1000 N according to GS-ET 19)
- Status display with 4 LEDs 24 V DC;
  - 1: AS-i, 2: FAULT, 3: F-IN1, 4: F-IN2

## Safety level

The new 3SF1 324-1S.21-1BA4 safety position switches are also recommended in the case of series connections for protective door interlocking where reliable diagnostics and quick restart capability of equipment is required.

They feature:

- Feedback from the solenoid and
- No opening of the doors after the solenoid is unlocked.



With AS-i safety monitor or in DP/AS-i F-Link it is possible to achieve SIL 2 according to IEC 61508 or PL d according to ISO 13849-1.

## Comparison of versions

Safety switch	Contacts	Achievable safety level	Diagnostics	Reclose condition
Type	Actuator / magnet		Feedback from the solenoid	After unlocking the solenoid (depending on the type of evaluation)
3SF1 324-1S.21-1BA1	1 NC/1 NC	SIL 1 / PL c	✓	Door does <u>not</u> have to be opened
	1 NC/1 NC	SIL 2 / PL d	✓	Door must be opened
3SF1 324-1S.21-1BA3	2 NC	SIL 2 / PL d	--	Door does <u>not</u> have to be opened
3SF1 324-1S.21-1BA4	2 NC/1 NC	SIL 2 / PL d	✓	Door does <u>not</u> have to be opened

✓ yes  
-- no

## Selection and ordering data

Interlock <sup>1)</sup>	Contacts Actuators/ Solenoids	DT	Complete units
			Order No.
<b>1300 N locking force · Enclosure width 54 mm</b>			
<b>Spring-actuated locks</b>			
	• With auxiliary release	1 NC/1 NC	⊕ B <b>3SF1 324-1SD21-1BA1</b>
		2 NC/--	⊕ B <b>3SF1 324-1SD21-1BA3</b>
3SF1 324-1SD21-...		2 NC/1 NC	⊕ B <b>3SF1 324-1SD21-1BA4</b>
	• With auxiliary release with lock	1 NC/1 NC	⊕ B <b>3SF1 324-1SE21-1BA1</b>
	• With escape release from the front	1 NC/1 NC	⊕ B <b>3SF1 324-1SF21-1BA1</b>
		2 NC/1 NC	⊕ B <b>3SF1 324-1SF21-1BA4</b>
	• With escape release from the back and auxiliary release from the front	1 NC/1 NC	⊕ B <b>3SF1 324-1SG21-1BA1</b>
		2 NC/1 NC	⊕ B <b>3SF1 324-1SG21-1BA4</b>
3SF1 324-1SF21-...	• With emergency release from the back and auxiliary release from the front	1 NC/1 NC	⊕ B <b>3SF1 324-1SJ21-1BA1</b>
<b>Solenoid locks</b>			
		1 NC/1 NC	⊕ B <b>3SF1 324-1SB21-1BA1</b>
		2 NC/--	⊕ B <b>3SF1 324-1SB21-1BA3</b>
3SF1 324-1SB21-...			

⊕ Positive opening according to IEC 60947-5-1, Appendix K.

<sup>1)</sup> Supplied without actuator. Please order separately.

For actuators and optional accessories see page 2/85.

# 3SF1 AS-Interface position switches

## With interlocking

Metal enclosures  
With locking force greater than 2000 N

### Overview



#### 5 directions of approach · Degree of protection IP66 / IP67

- Slow-action contacts:  
Version -1BA1: ASIsafe channel 1 on 1 NC contact from the actuator and channel 2 on 1 NC contact from the solenoid
- Solenoid: Rated operational voltage 24 V DC
- Locking force 2600 N (2000 N according to GS-ET 19)
- Status display with 4 LEDs 24 V DC;  
1: AS-i, 2: FAULT, 3: F-IN1, 4: F-IN2

#### Safety level

See page 2/87.

### Selection and ordering data

Interlock <sup>1)</sup>	Contacts Actuators/ Solenoids	DT	Complete units
			Order No.
<b>2600 N locking force · Enclosure width 54 mm</b>			
<b>Spring-actuated locks</b>			
	• With auxiliary release • With auxiliary release with lock	1 NC/1 NC 1 NC/1 NC	⊕ B 3SF1 314-1SD11-1BA1 ⊕ B 3SF1 314-1SE11-1BA1
3SF1 314-1SD21-...			
	• With escape release from the front • With escape release from the back and auxiliary release from the front • With emergency release from the back and auxiliary release from the front	1 NC/1 NC 1 NC/1 NC 1 NC/1 NC	⊕ B 3SF1 314-1SF11-1BA1 ⊕ B 3SF1 314-1SG11-1BA1 ⊕ B 3SF1 314-1SJ11-1BA1
3SF1 314-1SF21-...			
	<b>Solenoid locks</b>	1 NC/1 NC	⊕ B 3SF1 314-1SB11-1BA1
3SF1 314-1BF21-...			

⊕ Positive opening according to IEC 60947-5-1, Appendix K.

<sup>1)</sup> Supplied without actuator. Please order separately.

For actuators and optional accessories see page 2/85.

**Overview**

The 3SF1 hinge switches with safety-oriented communication can be directly connected using the AS-Interface bus system. The safety functions no longer have to be conventionally wired up.

With the 3SF1 position switches the ASIsafe electronics are integrated in the switch enclosure.

The hinge switches are provided for mounting on hinges. There are two actuator variants here:

- Hollow shaft, inner diameter 8 mm, outer 12 mm
- Solid shaft, diameter 10 mm

For the ASIsafe version of the hinge switch, the basic switch and twist actuator must be ordered separately. The basic switches correspond to the position switches of the standard version (only use versions with snap-action contacts).

The standards and approvals are the same as for the 3SF1 standard switches (see page 2/74).

**Selection and ordering data****Modular system**

1 or 2 contacts · 3 LEDs · Degree of protection IP65 (31 mm) or IP66 / IP67 (50 mm) · M12 connector socket

Version	Contacts	LEDs	DT	Modular system
				Order No. 

**Basic switches - Enclosure width 31 mm according to EN 50047**

ASIsafe basic switch

**With teflon plunger, with M12 connector socket,** 4-pole, channel 1 on NC contact, channel 2 on NC contact

Snap-action contacts      2 NC      24 V DC      ⤴ B      **3SF1 234-1LC05-1BA1**

**Basic switches - Enclosure width 50 mm**

ASIsafe basic switch

**With teflon plunger, with M12 connector socket,** 4-pole, channel 1 on NC contact, channel 2 on M12 socket, right

Snap-action contacts      1 NC      24 V DC      ⤴ B      **3SF1 244-1LC05-1BA2**

**Actuator heads**

Twist actuator with hollow shaft

**With hollow shaft**  
Operating angle 10°

B      **3SE5 000-0AU21**



Twist actuator with solid shaft

**With solid shaft**  
Operating angle 10°

B      **3SE5 000-0AU22**

⤴ Positive opening according to IEC 60947-5-1, Appendix K.

# 3SF1 AS-Interface position switches

## Hinge switches

### Metal enclosures

Enclosure width 31 mm / 40 mm / 56 mm

### Overview

The 3SF1 hinge switches with safety-oriented communication can be directly connected using the AS-Interface bus system. The safety functions no longer have to be conventionally wired up.

With the 3SF1 position switches the ASIsafe electronics are integrated in the switch enclosure.

The hinge switches are provided for mounting on hinges. There are two actuator variants here:

- Hollow shaft, inner diameter 8 mm, outer 12 mm
- Solid shaft, diameter 10 mm





For the ASIsafe version of the hinge switch, the basic switch and twist actuator must be ordered separately. The basic switches correspond to the position switches of the standard version (only use versions with snap-action contacts).

The standards and approvals are the same as for the 3SF1 standard switches (see page 2/74).

### Selection and ordering data

#### Modular system

1 or 2 contacts · 3 LEDs · Degree of protection IP66 / IP67 · M12 connector socket

Version	Contacts	LEDs	DT	Modular system	Order No.	
<b>Basic switches - Enclosure width 31 mm according to EN 50047</b>						
	<b>With plunger</b> With M12 connector socket, 4-pole, channel 1 on NC contact, channel 2 on NC contact Snap-action contacts		2 NC	24 V DC	⊕ B	<b>3SF1 214-1LC05-1BA1</b>
ASIsafe basic switch						
<b>Basic switches - Enclosure width 40 mm according to EN 50041</b>						
	<b>With M12 connector socket</b> , 4-pole, channel 1 on NC contact, channel 2 on NC contact Snap-action contacts		2 NC	24 V DC	⊕ B	<b>3SF1 114-1LA00-1BA1</b>
ASIsafe basic switch						
<b>Basic switches - Enclosure width 56 mm</b>						
	<b>With M12 connector socket</b> , 4-pole, channel 1 on NC contact, channel 2 on M12 socket, right Snap-action contacts		1 NC	24 V DC	⊕ B	<b>3SF1 124-1LA00-1BA2</b>
ASIsafe basic switch						
<b>Actuator heads</b>						
	<b>Hollow shaft</b> Operating angle 10°				B	<b>3SE5 000-0AU21</b>
Twist actuator with hollow shaft						
	<b>Solid shaft</b> Operating angle 10°				B	<b>3SE5 000-0AU22</b>
Twist actuator with solid shaft						

⊕ Positive opening according to IEC 60947-5-1, Appendix K.



## Overview



Switching magnets and contact blocks

A magnetically operated switch is comprised of a coded switching magnet and a switching element (sensor unit). Evaluation requires a safety relay or connection to a bus system.

**3SE6 806 safety relays**

Up to six protective devices (sensors) can be connected to the safety relay.

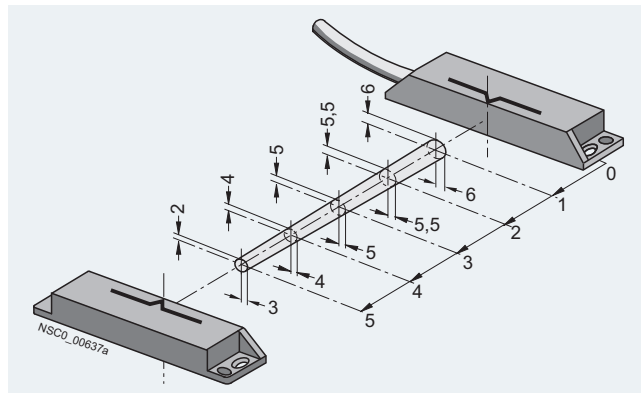

Enabling range (example)

The device has six current-sourcing semiconductor outputs (Y1 ... Y6) which signal the state of the connected protective devices.

The 3SE6 806 safety relay has two floating enabling circuits (safe circuits) as NO contact circuits and one floating signaling circuit as a NC circuit. The number of enabling circuits can be increased by adding one or more 3TK28 30 expansion modules.

## Application

SIRIUS 3SE6 magnetically operated switches are designed for mounting on movable protective guards (hoods, hinge switches, doors, etc.). Evaluation can be performed by means of a safety relay or through connection to a bus system.

The 3SE6 6 non-contact, magnetically operated safety switches stand out due to their enclosed design with degree of protection IP67. They are particularly suitable therefore for areas exposed to contamination, cleaning or disinfecting.

A magnetic monitoring system comprises one or more magnetically operated switches and an evaluation unit, e.g. a safety relay. When contact blocks 1 NO + 1 NC are used the 3SE6 806 safety relay provides a high degree of protection against manipulation and can be installed in safety circuits up to Category 3 according to ISO 13849-1 (EN 954-1).

**Combination of monitoring units and magnetically operated switches**







Monitoring units		Magnetically operated switches (contact block + switching magnet)				Achievable category (EN 954-1)/ Performance level (EN ISO 13849-1)
		1 NC + 1 NO		2 NC		
		3SE6 605-1BA	3SE6 605-2BA	3SE6 605-3BA	3SE6 604-2BA	
		3SE6 704-1BA	3SE6 704-2BA	3SE6 704-3BA	3SE6 704-2BA	
<b>Relay outputs</b>						
SIRIUS safety relays, 6-fold	3SE6 806-2CD00	✓	✓	✓	--	<b>Cat. 3</b>
SIRIUS safety relays	3TK28 26	✓	✓	✓	✓	<b>Cat. 4/e</b>
<b>Solid-state outputs</b>						
SIRIUS safety relays	3TK28 40	--	--	--	✓	<b>Cat. 3/d</b>
	3TK28 41, 3TK28 42, 3TK28 45	--	--	--	✓	<b>Cat. 4/e</b>
SIRIUS safety relays with contactor relay	3TK28 50, 3TK28 51, 3TK28 52	--	--	--	✓	<b>Cat. 3/d</b>
	3TK28 53	--	--	--	✓	<b>Cat. 4/e</b>
ASIsafe compact safety modules	3RK1 205, 3RK1 405	--	--	--	✓	<b>Cat. 4</b>
SIMATIC S7-31xF-2 DP or SIMATIC ET 200M	SM 326 F, 24 DI, 24 V DC SM 326 F, 8 DI, NAMUR	✓	✓	✓	✓	<b>Cat. 4</b>
SIMATIC ET 200S PROFIsafe	4/8 F-DI / 3 F-DO, 24 V DC	✓	✓	✓	✓	<b>Cat. 3</b>
	4/8 F DI, 24 V DC	✓	✓	✓	✓	<b>Cat. 4</b>
SIMATIC ET 200eco	4/8 F DI, 24 V DC	✓	✓	✓	✓	<b>Cat. 4</b>
SIMATIC ET 200pro	8/16 F-DI, 24 V DC, 4/8 F-DI / 4 F-DO 2 A, 24 V DC, F-Switch	✓	✓	✓	✓	<b>Cat. 4</b>
Modular Safety System	3RK3	✓	✓	✓	✓	<b>Cat. 4/e</b>

✓ Suitable magnetically operated switch

# 3SE6 magnetically operated switches

## Magnetic monitoring systems

### Selection and ordering data

Version	Size mm	Contacts	DT	Order No.
<b>Round sensor units</b>				
	<b>Switching magnets (coded)</b>	M30	A	<b>3SE6 704-1BA</b>
	<b>Contact blocks</b>			
	• With cable, 3 m	M30	1 NO + 1 NC A	<b>3SE6 605-1BA</b>
	• With M12 plug, 4-pole	M30	1 NO + 1 NC C	<b>3SE6 605-1BA02</b>
<b>Rectangular sensor units</b>				
	<b>Switching magnets (coded)</b>	25 × 88	A	<b>3SE6 704-2BA</b>
	<b>Contact blocks</b>			
	• With cable, 3 m	25 × 88	1 NO + 1 NC A	<b>3SE6 605-2BA</b>
			2 NC A	<b>3SE6 604-2BA</b>
	• With M8 plug, 4-pole	25 × 88	1 NO + 1 NC C	<b>3SE6 605-2BA01</b>
			2 NC C	<b>3SE6 604-2BA01</b>
	<b>Switching magnets (coded)</b>	25 × 33	A	<b>3SE6 704-3BA</b>
	<b>Contact blocks</b> with cable, 3 m	25 × 33	1 NO + 1 NC A	<b>3SE6 605-3BA</b>
<b>Accessories</b>				
	<b>Spacers</b>	25 × 88	D	<b>3SX3 260</b>
	<b>Spacers</b>	25 × 33	D	<b>3SX3 261</b>
Version	Number of sensors	Enabling/ signaling circuits	DT	Order No.

### Monitoring units

	<b>Safety relays with relay output, 6-fold</b> Rated control supply voltage 24 V DC	6	2 NO / 1 NC	B	<b>3SE6 806-2CD00</b>
---	--	---	-------------	---	-----------------------

For more monitoring units, see catalog IC 10, chapters 6 and 7 "Monitoring and Control Devices" and catalog IK PI.

Notes

# Commanding and signaling devices

## Introduction

### Overview

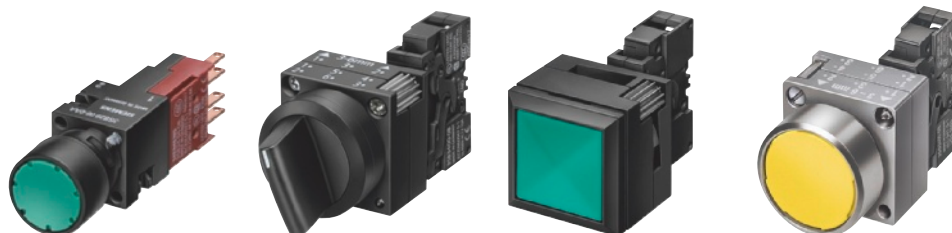

3SB2

3SB30, 3SB32

3SB31, 3SB33

3SB35, 3SB36

#### Pushbuttons and indicator lights

Designs				
Nominal diameter	16 mm	22 mm	26 mm × 26 mm	22 mm
Version	Plastic, round	Plastic, round	Plastic, square	Metal, round
<b>Actuators</b>				
Pushbuttons and switches	✓ <sup>1)</sup>	✓	✓	✓
Illuminated pushbuttons and switches	✓ <sup>1)</sup>	✓	✓	✓
Mushroom pushbuttons	--	✓	--	✓
Push-pull buttons	--	✓	--	✓
EMERGENCY-STOP mushroom pushbuttons	✓	✓	✓	✓
Selector switches	✓	✓	✓	✓
Key-operated switches	✓	✓	✓	✓
<b>Special actuators</b>				
Coordinate switches	--	✓	--	--
Twin pushbuttons	--	✓	--	--
Potentiometer drives	--	✓	--	--
<b>Indicators</b>				
Indicator lights	✓	✓	✓	✓
Acoustic signaling devices	--	✓	--	--
<b>Contact blocks</b>				
Single-pole	✓	✓	✓	✓
Two-pole	✓	✓	✓	✓
<b>Lampholders</b>				
Wedge bases	✓	✓ (with solder connections)	✓ (with solder connections)	✓ (with solder connections)
BA 9s bases	--	✓	✓	✓
With integrated LED	--	✓	✓	✓
<b>Connections</b>				
Plug-in connection	✓	--	--	--
Screw terminals	--	✓	✓	✓
Spring-type terminals	--	✓	✓	✓
Solder pins	✓	✓	✓	✓
AS-Interface	--	✓	✓	✓

#### AS-Interface solutions

Commanding and signaling devices of the SIRIUS 3SB3 series can be connected to the AS-Interface communication system quickly and easily with the help of various solutions.

For AS-Interface solutions, see catalog IK PI "Industrial Communication for Automation & Drives".

#### AS-Interface EMERGENCY-STOP according to ISO 13850

Using a special F adapter, EMERGENCY-STOP devices according to ISO 13850 (former EN 418) can be directly connected through the standard AS-Interface with safety-oriented communication (see page 2/110).

#### AS-Interface enclosures

Enclosures with standard fittings are listed in this catalog. For customized enclosures, use the 3SB configurator to select the elements for equipping (see page 2/118).

✓ Standard

-- Not available

□ Optional

<sup>1)</sup> Only pushbuttons, no pushbutton switches.

#### AS-Interface front panel modules

The front panel module has one 4I/4O slave for connection of four 3SB3 commanding or signaling devices (see Catalog IK PI).

*Note:*

For safety characteristics see catalog IC 10 "Appendix" --> "Standards and approvals" --> "Overview"



	3SB38	3SB38 6	3SE7, 3SF2	3SE29
	Enclosures	Two-hand operation consoles	Cable-operated switches	Foot switches
<b>Enclosures</b>				
Plastic	✓	✓	--	✓
Metal	✓	✓	✓	✓
<b>Actuators</b>				
Pushbuttons and switches	✓	✓	✓	✓
Illuminated pushbuttons and switches	✓	✓	--	--
Mushroom pushbuttons	✓	✓	--	--
Push-pull buttons	✓	☐	--	--
EMERGENCY-STOP mushroom pushbuttons	✓	✓	✓	--
Selector switches	✓	☐	--	--
Key-operated switches	✓	☐	--	--
Bowden wires	--	--	✓	--
<b>Indicators</b>				
Indicator lights	✓	☐	✓	--
Acoustic signaling devices	✓	☐	--	--
<b>Contact blocks</b>				
Single-pole	✓	✓	--	--
Two-pole	--	✓	✓	✓
Three-pole	--	--	--	✓
Four-pole	--	--	✓	✓
<b>Connections</b>				
Screw terminals	✓	✓	✓	✓
Spring-type terminals	✓	☐	--	--
Molded cables	--	--	--	✓
Plug-in connection	☐	☐	☐	☐
AS-Interface	✓	☐	✓	--



	8WD42, 8WD44	8WD53
	Signaling columns	Integrated signal lamps
<b>Enclosures</b>		
Plastic	✓	✓
Metal	--	--
<b>Lighting</b>		
Incandescent lamps	✓	✓
LEDs	✓	✓
Flashlights	✓	✓
<b>Connections</b>		
Screw terminals	✓	✓
Spring-type terminals	✓	--
AS-Interface	✓	--

# 3SB2 Pushbuttons and indicator lights, 16 mm

## General data

### Overview

The 3SB2 pushbuttons and indicator lights are provided for front plate mounting and rear connection with flat connectors. For use on printed circuit boards, contact blocks and lampholders with solder pins are also available.

### Standards

IEC 60947-1, EN 60947-1,  
IEC 60947-5-1, EN 60947-5-1,  
IEC 60947-5-5, EN 60947-5-5 for EMERGENCY-STOP  
mushroom pushbuttons.

### Version with flat connector

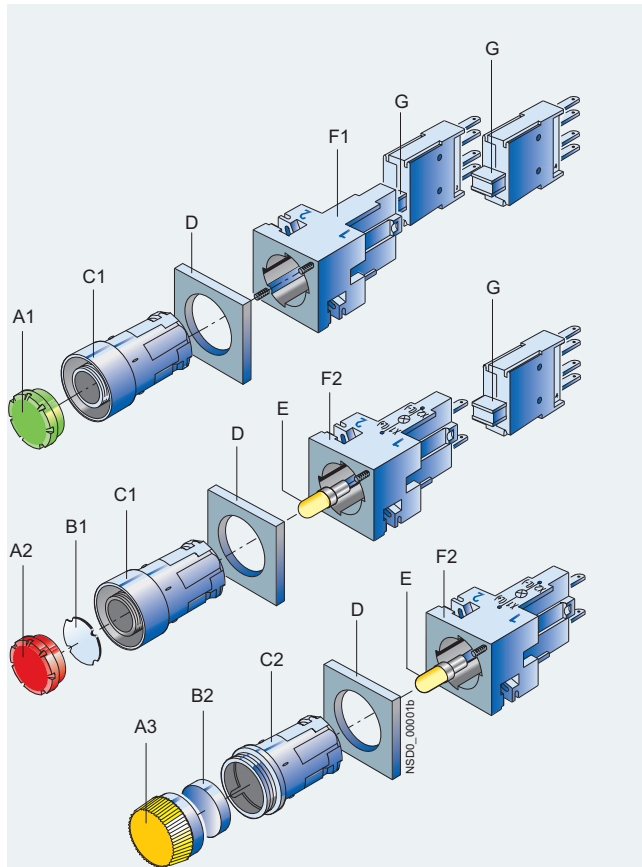

- A1 Button, flat
- A2 Illuminated button, flat
- A3 Screw lens for indicator light
- B1 Insert label, for labeling
- B2 Insert cap, for labeling
- C1 Collar with extruded front ring
- C2 Collar for indicator light
- D Frame for rectangular design
- E Wedge base lamp, W2 x 4.6d
- F1 Holders
- F2 Lampholder with holder
- G Contact blocks (1NO or 1NC) for snapping onto the holder or onto the lampholder(1NO or 1NC)

### For PCB mounting

For use on printed circuit boards, special contact blocks and lampholders for soldering into the printed circuit board are available. For this purpose, the contact blocks and lampholders are fitted with 0.8 mm x 0.8 mm solder pins of length 3.5 mm.

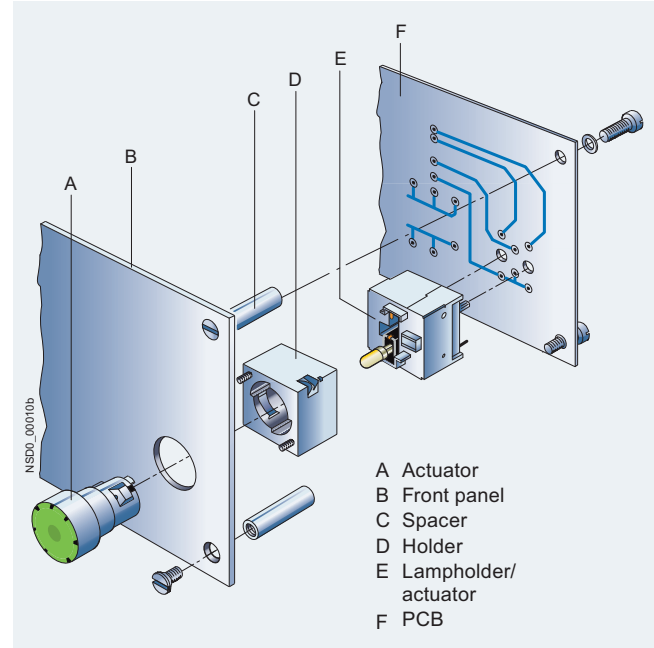

### Connection methods



Flat connectors



Solder pin connections

The terminals are indicated in the corresponding tables by the symbols shown on orange backgrounds.

### Application

The devices are climate-proof and suitable for marine applications.

### Safety EMERGENCY-STOP pushbuttons according to ISO 13850

For controls according to IEC 60204-1 or EN 60204-1 (VDE 0113 Part 1), the mushroom pushbuttons of the 3SB2 series are suitable for use as safety EMERGENCY-STOP pushbuttons.

### Safety circuits

IEC 60947-5-1 and EN 60947-5-1 require positive opening, i.e. for the purposes of personal safety, the assured opening of NC contacts is expressly stipulated for the electrical equipment of machines in all safety circuits and marked according to IEC 60947-5-1 with the symbol

Category 4 according to EN 954-1 can be attained with the EMERGENCY-STOP mushroom pushbuttons if the corresponding failsafe evaluation units are selected and correctly installed, e.g. the 3TK28 safety relays or matching units from the ASIsafe, SIMATIC or SINUMERIK product ranges.

# 3SB2 Pushbuttons and indicator lights, 16 mm

Complete units

## Selection and ordering data

Version	Contact blocks	Color of handle	DT	Flat connectors
	1 NC → <sup>2)</sup>	Red	▶	Order No. <b>3SB22 03-1AC01</b>



EMERGENCY-STOP  
mushroom pushbutton

**EMERGENCY-STOP mushroom pushbuttons acc. to ISO 13850, latching<sup>1)</sup>**  
 Latches automatically when pressed; unlatches by turning the mushroom head anticlockwise, with yellow name plate, with inscription "NOT-HALT"

<sup>1)</sup> The mushroom pushbutton cannot be combined with 3SB29 02-0AB name plate or 3SB29 02-0AA single frame.

<sup>2)</sup> Positive opening according to IEC 60947-5-1, Appendix K.

2

# 3SB2 Pushbuttons and indicator lights, 16 mm

## Actuators and indicators

### Selection and ordering data

Version	Color of handle	DT	Order No.
---------	-----------------	----	-----------

#### Pushbuttons



**EMERGENCY-STOP mushroom pushbuttons acc. to ISO 13850, latching<sup>1)</sup>**  
 Latches automatically when pressed; unlatches by turning the mushroom head anticlockwise

Red



**3SB20 00-1AC01**

EMERGENCY-STOP  
mushroom pushbutton

<sup>1)</sup> The mushroom pushbutton cannot be combined with 3SB29 02-0AB name plate or 3SB29 02-0AA single frame.

2



# 3SB2 Pushbuttons and indicator lights, 16 mm

## Contact blocks and lampholders

### Selection and ordering data

Version	Diagram	Operating travel <input type="checkbox"/> Contact closed <input type="checkbox"/> Contact open	DT	Flat connectors
				Order No.

#### Contact blocks and lampholders with flat connectors 2 × 2.8 – 0.8 mm according to IEC 60760



Holder

#### Holders for fixing the actuator and the contact blocks

Holders for 2 contact blocks  
 Inscription with identification number 1-2

▶	<b>3SB29 08-0AA</b>
---	---------------------

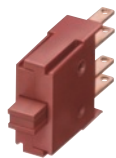

Contact block

#### Contact blocks for fixing in the holder or lampholder

##### Contact blocks with one contact <sup>1)</sup>

1 NO

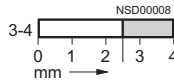

▶	<b>3SB24 04-0B</b>
---	--------------------

1 NC → <sup>2)</sup>

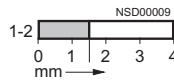

▶	<b>3SB24 04-0C</b>
---	--------------------

<sup>1)</sup> For plug-in and insulation sleeves, see Accessories.

<sup>2)</sup> Positive opening according to IEC 60947-5-1, Appendix K.

Version	Diagram	Operating travel <input type="checkbox"/> Contact closed <input type="checkbox"/> Contact open	DT	Solder pin connections
				Order No.

#### Contact blocks and lampholders with solder pins



Holder

#### Holders for contact block with solder pins

For fixing the actuators in the front panel

C	<b>3SB29 08-0AB</b>
---	---------------------



Contact block with solder pins

#### Contact blocks

1 NO

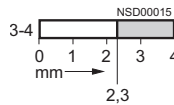

B	<b>3SB24 55-0B</b>
---	--------------------

1 NC → <sup>1)</sup>

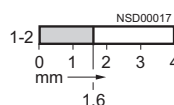

B	<b>3SB24 55-0C</b>
---	--------------------

1 NO + 1 NC → <sup>1)</sup>

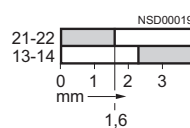
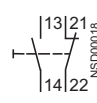

B	<b>3SB24 55-0J</b>
---	--------------------

1 NC + 1 NC → <sup>1)</sup>

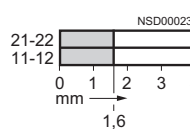

B	<b>3SB24 55-0F</b>
---	--------------------

<sup>1)</sup> Positive opening according to IEC 60947-5-1, Appendix K.

2

# 3SB2 Pushbuttons and indicator lights, 16 mm

## Name plates





### Overview

The name plates consist of a black plastic label holder and an inscription label (silver with black print) for sticking in place.

Note mounting dimensions!

### Inscriptions

The inscriptions (also special inscriptions) are lower case with upper case initial letters. Graphic symbols, including those not listed in the catalog, are according to ISO 7000 or IEC 60417.

Version	DT	Order No.
<b>Accessories for command points</b>		
 3SB29 08-2AG	<b>Name plates, yellow, Ø 50 mm</b> As backing plate for EMERGENCY STOP, self-adhesive <ul style="list-style-type: none"> <li>• Blank</li> <li>• With German inscription "NOT-HALT"</li> <li>• With German inscription "NOT-AUS"</li> </ul>	▶ <b>3SB29 08-2AF</b> ▶ <b>3SB29 08-2AG</b> ▶ <b>3SB29 08-2AK</b>
<b>Flat connectors</b>		
 3SB29 08-8AA	<b>Plug-in sleeves</b> For flat connectors 2.8 × 0.8 mm, cross-section 0.5 ... 1.5 mm <sup>2</sup>	A <b>3SB29 08-8AA</b>
 3SB29 08-8AB	<b>Insulation sleeves</b> For flat connectors, connection from the front	D <b>3SB29 08-8AB</b>
 3SB29 08-8AD	<b>Complete connectors<sup>1)</sup></b> For connecting contact blocks and lampholders (up to 10 connections). Guaranteed finger-safe acc. to IEC 61140 and VBG 4.	B <b>3SB29 08-8AD</b>
 3SB29 08-8AE	<b>Plug-in sleeves</b> For flat connectors 2.8 × 0.8 mm, with locating spring for latching in complete connector	B <b>3SB29 08-8AE</b>

<sup>1)</sup> Required 3SB29 08-8AE plug-in sleeves for flat connectors 2.8 × 0.8 mm are not included in the scope of supply.

## Overview

## Front plate mounting

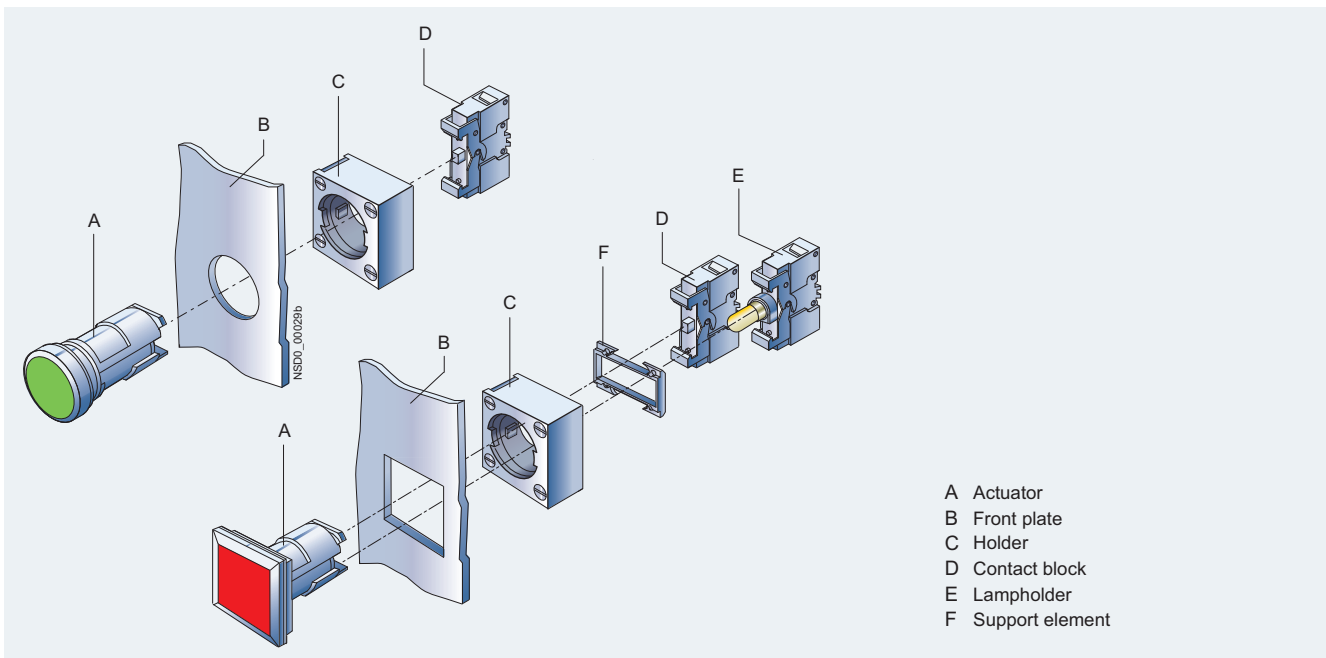

Actuators, contact blocks and lampholders

## Used on printed circuit boards

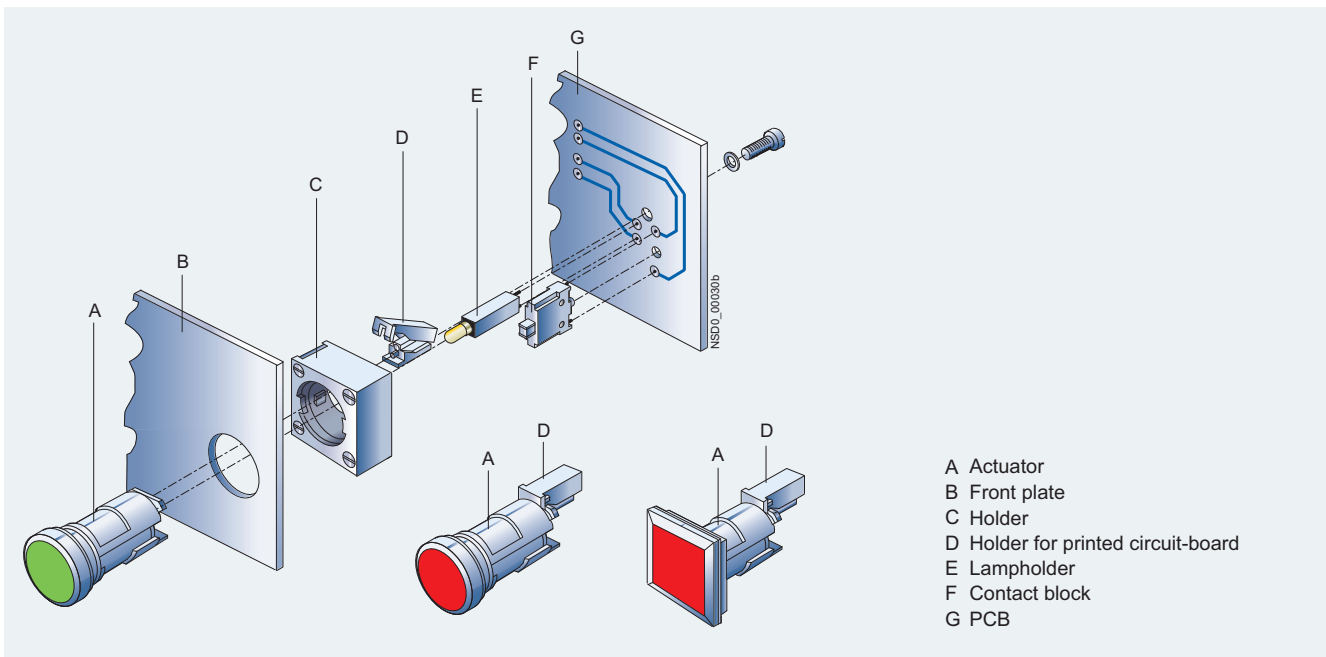

Contact blocks for use on printed circuit boards.

# 3SB3 Pushbuttons and indicator lights, 22 mm

## General data

### Design

The 3SB3 series is a modular range of commanding and signaling devices for front panel mounting and rear conductor connection. As an alternative, individual elements can also be supplied for use on printed circuit boards. Complete units are offered for the most commonly used applications.

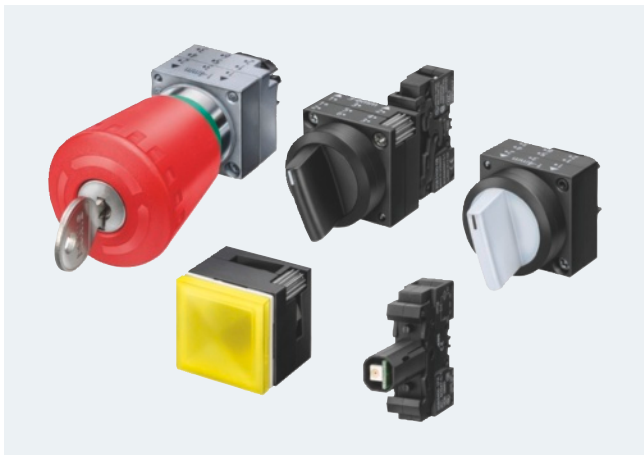

Actuators and indicators and complete units

The 3SB3 series is available:

- Made of molded plastic in flat, round and square design
- Made of metal in round design.

The devices are of modern industrial design and can be mounted rapidly by a single person. The operating surfaces of the pushbuttons and illuminated pushbuttons are concave. The lenses of the indicator lights are convex.

The metal version with a high degree of protection according to IP67 and NEMA 4 is available for the world market.

One command point comprises:

- An actuator or lens assembly in front of the control panel
- A holder for mounting behind the control panel
- Up to 3 contact blocks and/or 1 lampholder behind the control panel
- A comprehensive range of accessories for inscription

Two contact blocks can be snapped onto the actuator in the standard version.

When three contact blocks or illuminated actuators are required, an additional holder must be plugged onto the actuator from the rear.

- 3SB39 01-0AB holder for 3 contact blocks or for 2 contact blocks and 1 lampholder
- 3SB39 01-0AC holder with pressure plates for actuating a central contact block when using a selector switch, key-operated switch and twin pushbutton with 3 contact blocks.

For illuminated pushbuttons, illuminated switches and illuminated selector switches the holder is included in the scope of supply as standard.



The contact blocks are fitted with a slow-action contact (1 NO contact or 1 NC contact) with double operating contacts. These ensure a high switching reliability even with small voltages and currents, such as 5 V/1 mA. They are suitable for use in solid-state systems as well as conventional controls.

### Standards

IEC 60947-1, EN 60947-1,  
IEC 60947-5-1, EN 60947-5-1,  
IEC 60947-5-5, EN 60947-5-5 for EMERGENCY-STOP mushroom pushbuttons.

### Connection methods

The devices are available with screw terminals (box terminals), spring-type terminals or solder pins.

-  Screw terminals
-  Spring-type terminals
-  Solder pin connections

The terminals are indicated in the corresponding tables by the symbols shown on orange backgrounds.

### Application

The devices are climate-proof (KTW 24) and suitable for standard industrial applications and operation in marine applications. For operation in oily atmospheres (organic oils/lubricants) we recommend actuators which are marked as "solvent-resistant".

### AS-Interface solutions

The 3SB3 commanding and signaling devices can be connected to the AS-Interface communication system quickly and safely with the help of various solutions.

The following solutions are available:

- ASIsafe EMERGENCY-STOP mushroom pushbuttons (see page 2/110)
- AS-Interface enclosures with 1 to 6 command points (see page 2/118).
- AS-Interface front panel modules for 4 command points (see Catalog IK PI)

### "Intrinsic safety" type of protection EEx i according to ATEX directive 94/9/EC

The pushbuttons and indicator lights in round design can also be used in hazardous areas. The 3SB34 ...-0. contact blocks and the 3SB34 ...-1A lampholders (with 3SB39 01-1.A LED lamp) with screw terminals or spring-type terminals can be used.

See Chapter 13 "Appendix" --> "Standards and Approvals" --> "Ex Protection Certificates for SIRIUS Controls".

### Safety EMERGENCY-STOP pushbuttons according to ISO 13850

For controls according to IEC 60204-1 or EN 60204-1 (VDE 0113 Part 1), the mushroom pushbuttons of the 3SB3 series are suitable for use as safety EMERGENCY-STOP pushbuttons.

### Safety circuits

IEC 60947-5-1 and EN 60947-5-1 require positive opening, i.e. for the purposes of personal safety, the assured opening of NC contacts is expressly stipulated for the electrical equipment of machines in all safety circuits and marked according to IEC 60947-5-1 with the symbol .



Category 4 according to EN 954-1 can be attained with the EMERGENCY-STOP mushroom pushbuttons if the corresponding failsafe evaluation units are selected and correctly installed, e.g. the 3TK28 safety relays or matching units from the ASIsafe, SIMATIC or SINUMERIK product ranges.

# 3SB3 Pushbuttons and indicator lights, 22 mm

## Actuators and indicators, plastic, round, 22 mm

Complete units

### Selection and ordering data

Color of handle	Contacts for front plate mounting	DT	Screw terminals 	DT	Spring-type terminals 
			Order No.		Order No.

#### EMERGENCY-STOP devices according to ISO 13850, with yellow name plate, Ø 80 mm, with inscription





With rotate-to-unlatch mechanism



#### EMERGENCY-STOP mushroom pushbuttons, Ø 40 mm, with positive latching function

With rotate-to-unlatch mechanism



- German inscription "NOT-HALT"

Red	1 NC	
Red	1 NC with mounting monitoring	
Red	1 NO + 1 NC	

- English inscription "EMERGENCY STOP"

Red	1 NC	
Red	1 NC with mounting monitoring	
Red	1 NO + 1 NC	

- French inscription "ARRET D'URGENCE"

Red	1 NC	
Red	1 NO + 1 NC	

3SB32 03-1HA20

3SB32 66-1HA20

3SB32 01-1HA20

3SB32 03-1HA20-0CC0

--

3SB32 01-1HA20-0CC0

3SB32 03-1HR20

3SB32 66-1HR20

3SB32 01-1HR20

3SB32 03-1HP20

3SB32 01-1HP20

--

--

--

--



--





With rotate-to-unlatch mechanism and switch position indication

#### With rotate-to-unlatch mechanism and mechanical switch position indication

- German inscription "NOT-HALT"

Red	1 NC	
Red	1 NC with mounting monitoring	
Red	1 NO + 1 NC	

- English inscription "EMERGENCY STOP"

Red	1 NC	
Red	1 NC with mounting monitoring	
Red	1 NO + 1 NC	

3SB32 03-1HA26

3SB32 66-1HA26

3SB32 01-1HA26

3SB32 03-1HR26

3SB32 66-1HR26

3SB32 01-1HR26

3SB32 03-1HA26-0CC0

--

3SB32 01-1HA26-0CC0

--

--



--





With pull-to-unlatch mechanism

#### With pull-to-unlatch mechanism

- German inscription "NOT-HALT"

Red	1 NC	
Red	1 NO + 1 NC	

- English inscription "EMERGENCY STOP"

Red	1 NC	
Red	1 NO + 1 NC	

3SB32 03-1TA20

3SB32 01-1TA20

3SB32 03-1TR20

3SB32 01-1TR20

--

--

--

--

<sup>1)</sup> Positive opening according to IEC 60947-5-1, Appendix K. Can be used with 3TK28 safety relays. Certificate:



# 3SB3 Pushbuttons and indicator lights, 22 mm

## Actuators and indicators, plastic, round, 22 mm

### Actuators and indicators

#### Selection and ordering data

Version	Color of handle	Approval	DT	Order No.
<b>EMERGENCY-STOP devices according to ISO 13850 and IEC 60947-5-5, with holder<sup>1)2)</sup>. Can also be used with 3TK28 safety relays.</b>				
	Red		B	<b>3SB30 00-1FA20</b>
Mushroom diameter 32 mm	<b>EMERGENCY-STOP mushroom pushbuttons, Ø 32 mm</b> With positive latching according to ISO 13850, with rotate-to-unlatch mechanism			
	Red		▶ A	<b>3SB30 00-1HA20</b> <b>3SB30 00-1HA26</b>
Mushroom diameter 40 mm, with rotate-to-unlatch mechanism with switch position indication	<b>EMERGENCY-STOP mushroom pushbuttons, Ø 40 mm</b> With positive latching according to ISO 13850, with rotate-to-unlatch mechanism • Without switch position indicator • With mechanical switch position indication			
	Red		B	<b>3SB30 00-1TA20</b>
Mushroom diameter 40 mm, pull-to-unlatch mechanism	<b>EMERGENCY-STOP mushroom pushbuttons, Ø 40 mm</b> With positive latching according to ISO 13850, with pull-to-unlatch mechanism			
	Red		B	<b>3SB30 00-1AA20</b>
Mushroom diameter 60 mm	<b>EMERGENCY-STOP mushroom pushbuttons, Ø 60 mm</b> With positive latching according to ISO 13850, with rotate-to-unlatch mechanism			
	Red		B	<b>3SB30 00-1BA20</b>
Mushroom diameter 40 mm, with RONIS key-operated switch	<b>EMERGENCY-STOP mushroom pushbuttons, Ø 40 mm, with RONIS key-operated switch</b> , lock No. SB 30, with positive latching according to ISO 13850, unlocking only possible using key			
	Red		B	<b>3SB30 00-1KA20</b>
Mushroom diameter 40 mm, with CES key-operated switch	<b>EMERGENCY-STOP mushroom pushbuttons, Ø 40 mm, with CES key-operated switch</b> , lock No. SSG 10, with positive latching according to ISO 13850, unlocking only possible using key			
	Red		B	<b>3SB30 00-1LA20</b>
Mushroom diameter 40 mm, with BKS key-operated switch	<b>EMERGENCY-STOP mushroom pushbuttons, Ø 40 mm, with BKS key-operated switch</b> , lock No. S1, with positive latching according to ISO 13850, unlocking only possible using key			
	Red		B	<b>3SB30 00-1MA20</b>
Mushroom diameter 40 mm, with O.M.R. key-operated switch	<b>EMERGENCY-STOP mushroom pushbuttons, Ø 40 mm, with O.M.R. key-operated switch</b> , lock No. 73037, with positive latching according to ISO 13850, unlocking only possible using key			

For BKS and CES special locks, see catalog IC 10.

1) Also available without holder. Supplement Order No. with "-Z" and quote order code "B01".

2) The yellow backing plates must be ordered separately, see Accessories.

# 3SB3 Pushbuttons and indicator lights, 22 mm

## Actuators and indicators, plastic, square, 26 mm x 26 mm

Complete units

## Selection and ordering data



Version	Color of handle	Contacts for front plate mounting	DT	<b>Screw terminals</b> 
				Order No.

**EMERGENCY-STOP devices acc. to ISO 13850, with yellow name plate, Ø 80 mm, with inscription<sup>1)</sup>. Can also be used with 3TK28 safety relays.**



**EMERGENCY-STOP mushroom pushbuttons, Ø 40 mm, with positive latching function**

With rotate-to-unlatch mechanism

Red 1 NC  <sup>2)</sup> B  
1 NO + 1 NC  <sup>2)</sup> B

3SB33 03-1HA20

3SB33 01-1HA20

EMERGENCY-STOP mushroom pushbutton  
Rotate-to-unlatch mechanism

<sup>1)</sup> German inscription "NOT-HALT".

<sup>2)</sup> Positive opening according to IEC 60947-5-1, Appendix K. Can be used with 3TK28 safety relays.  
Certificate:



2

# 3SB3 Pushbuttons and indicator lights, 22 mm

## Actuators and indicators, plastic, square, 26 mm x 26 mm

### Actuators and indicators

#### Selection and ordering data

Version	Color of handle	Approval	DT	Order No.
---------	-----------------	----------	----	-----------

**EMERGENCY-STOP devices according to ISO 13850 and IEC 60947-5-5, with holder<sup>1/2)</sup>.**

Can also be used with 3TK28 safety relays.



EMERGENCY-STOP mushroom pushbutton, rotate-to-unlatch mechanism

**EMERGENCY-STOP mushroom pushbuttons, Ø 40 mm, with positive latching**  
acc. to ISO 13850,  
rotate-to-unlatch mechanism

Red



B

**3SB31 10-1HA20**



EMERGENCY-STOP mushroom pushbutton with RONIS key-operated switch

**EMERGENCY-STOP mushroom pushbuttons, Ø 40 mm, with RONIS key-operated switch**  
(with 2 keys), lock No. SB 30,  
with positive latching  
acc. to ISO 13850,  
unlocking only possible using key

Red



B

**3SB31 10-1BA20**



EMERGENCY-STOP mushroom pushbutton with CES key-operated switch

**EMERGENCY-STOP mushroom pushbuttons, Ø 40 mm, with CES key-operated switch**  
(with 2 keys), lock No. SSG 10,  
with positive latching  
acc. to ISO 13850,  
unlocking only possible using key

Red



B

**3SB31 10-1KA20**



EMERGENCY-STOP mushroom pushbutton with BKS key-operated switch

**EMERGENCY-STOP mushroom pushbuttons, Ø 40 mm, with BKS key-operated switch**  
(with 2 keys),  
lock No. S1, with positive latching  
acc. to ISO 13850,  
unlocking only possible using key

Red



B

**3SB31 10-1LA20**

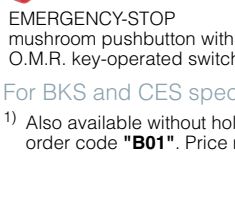

EMERGENCY-STOP mushroom pushbutton with O.M.R. key-operated switch

**EMERGENCY-STOP mushroom pushbuttons, Ø 40 mm, with O.M.R. key-operated switch**  
(with 2 keys), lock No. 73037  
with positive latching  
acc. to ISO 13850,  
unlocking only possible using key

Red



B

**3SB31 10-1MA20**

For BKS and CES special locks, see catalog IC 10

<sup>1)</sup> Also available without holder. Supplement Order No. with "-Z" and quote order code "B01". Price reduction approx. 1.70

<sup>2)</sup> The yellow backing plates must be ordered separately, see Accessories.





# 3SB3 Pushbuttons and indicator lights, 22 mm

## Actuators and indicators, metal, round, 22 mm

Complete units

## Selection and ordering data



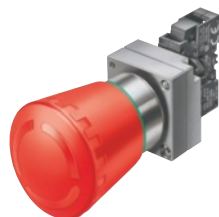

Color of handle	Contacts for front plate mounting	DT	Screw terminals 	DT	Spring-type terminals 
			Order No.		Order No.

**EMERGENCY-STOP devices according to ISO 13850, with yellow name plate, Ø 80 mm, with inscription**





EMERGENCY-STOP mushroom pushbutton with rotate-to-unlatch mechanism

**EMERGENCY-STOP mushroom pushbuttons, Ø 40 mm, with positive latching function**  
 With rotate-to-unlatch mechanism

- German inscription "NOT-HALT"

Red	1 NC		<sup>1)</sup>	<b>3SB36 03-1HA20</b>	<b>3SB36 03-1HA20-0CC0</b>
	1 NC with mounting monitoring		<sup>1)</sup>	<b>3SB36 66-1HA20</b>	--
	1 NO + 1 NC		<sup>1)</sup>	<b>3SB36 01-1HA20</b>	<b>3SB36 01-1HA20-0CC0</b>
	1 NC + 1 NC		<sup>1)</sup>	--	<b>3SB36 11-1HA20-0CC0</b>

- English inscription "EMERGENCY STOP"

Red	1 NC		<sup>1)</sup>	<b>3SB36 03-1HR20</b>	--
	1 NC with mounting monitoring		<sup>1)</sup>	<b>3SB36 66-1HR20</b>	--
	1 NO + 1 NC		<sup>1)</sup>	<b>3SB36 01-1HR20</b>	--

- French inscription "ARRET D'URGENCE"

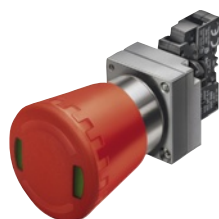

Red	1 NC		<sup>1)</sup>	<b>3SB36 03-1HP20</b>	--
	1 NO + 1 NC		<sup>1)</sup>	<b>3SB36 01-1HP20</b>	--





EMERGENCY-STOP mushroom pushbutton with rotate-to-unlatch mechanism and switch position indication

With rotate-to-unlatch mechanism and mechanical switch position indication

- German inscription "NOT-HALT"

Red	1 NC		<sup>1)</sup>	<b>3SB36 03-1HA26</b>	<b>3SB36 03-1HA26-0CC0</b>
	1 NC with mounting monitoring		<sup>1)</sup>	<b>3SB36 66-1HA26</b>	--
	1 NO + 1 NC		<sup>1)</sup>	<b>3SB36 01-1HA26</b>	<b>3SB36 01-1HA26-0CC0</b>

- English inscription "EMERGENCY STOP"

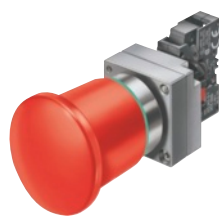

Red	1 NC		<sup>1)</sup>	<b>3SB36 03-1HR26</b>	--
	1 NC with mounting monitoring		<sup>1)</sup>	<b>3SB36 66-1HR26</b>	--
	1 NO + 1 NC		<sup>1)</sup>	<b>3SB36 01-1HR26</b>	--



EMERGENCY-STOP mushroom pushbutton with pull-to-unlatch mechanism

With pull-to-unlatch mechanism, solvent-resistant

- German inscription "NOT-HALT"

Red	1 NC		<sup>1)</sup>	<b>3SB36 03-1TA20</b>	<b>3SB36 03-1TA20-0CC0</b>
	1 NO + 1 NC		<sup>1)</sup>	<b>3SB36 01-1TA20</b>	<b>3SB36 01-1TA20-0CC0</b>
	1 NC + 1 NC		<sup>1)</sup>	--	<b>3SB36 11-1TA20-0CC0</b>

- English inscription "EMERGENCY STOP"

Red	1 NC		<sup>1)</sup>	<b>3SB36 03-1TR20</b>	--
	1 NO + 1 NC		<sup>1)</sup>	<b>3SB36 01-1TR20</b>	--

- French inscription "ARRET D'URGENCE"

Red	1 NC		<sup>1)</sup>	<b>3SB36 03-1TP20</b>	--
	1 NO + 1 NC		<sup>1)</sup>	<b>3SB36 01-1TP20</b>	--

<sup>1)</sup> Positive opening according to IEC 60947-5-1, Appendix K.  
Can be used with 3TK28 safety relays.  
Certificate:



# 3SB3 Pushbuttons and indicator lights, 22 mm

## Actuators and indicators, metal, round, 22 mm















### Actuators and indicators

#### Selection and ordering data

Version	Color of handle	Approval	DT	Order No.
---------	-----------------	----------	----	-----------

#### EMERGENCY-STOP devices according to ISO 13850 and IEC 60947-5-5 with holder<sup>1)2)</sup>.

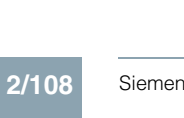
Can also be used with 3TK28 safety relays.

 Mushroom diameter 32 mm	<b>EMERGENCY-STOP mushroom pushbuttons, Ø 32 mm</b> With positive latching acc. to ISO 13850, with rotate-to-unlatch mechanism <ul style="list-style-type: none"> <li>• Standard version</li> <li>• Solvent-resistant</li> </ul>	Red 	B B	<b>3SB35 00-1FA20</b>
				<b>3SB35 00-1FA20-0PA0</b>
 Mushroom diameter 40 mm, with rotate-to-unlatch mechanism with switch position indication	<b>EMERGENCY-STOP mushroom pushbuttons, Ø 40 mm</b> With positive latching acc. to ISO 13850, with rotate-to-unlatch mechanism <ul style="list-style-type: none"> <li>• Without switch position indicator</li> <li>• Without switch position indicator, solvent-resistant</li> <li>• With mechanical switch position indication</li> </ul>	Red 	B B A B	<b>3SB35 00-1HA20</b>
				<b>3SB35 00-1HA20-0PA0</b>
				<b>3SB35 00-1HA26</b>
 Mushroom diameter 40 mm, pull-to-unlatch mechanism	With pull-to-unlatch mechanism		B	<b>3SB35 00-1TA20</b>
 Mushroom diameter 60 mm	<b>EMERGENCY-STOP mushroom pushbuttons, Ø 60 mm</b> With positive latching acc. to ISO 13850, with rotate-to-unlatch mechanism	Red 	B	<b>3SB35 00-1AA20</b>
 Mushroom diameter 40 mm, with RONIS key-operated switch	<b>EMERGENCY-STOP mushroom pushbuttons, Ø 40 mm, with RONIS key-operated switch</b> , (with 2 keys), lock No. SB 30, with positive latching according to ISO 13850, unlocking only possible using key	Red 	B	<b>3SB35 00-1BA20</b>
 Mushroom diameter 40 mm, with CES key-operated switch	<b>EMERGENCY-STOP mushroom pushbuttons, Ø 40 mm, with CES key-operated switch</b> , (with 2 keys), lock No. SSG 10, with positive latching according to ISO 13850, unlocking only possible using key	Red 	B	<b>3SB35 00-1KA20</b>
 Mushroom diameter 40 mm, with BKS key-operated switch	<b>EMERGENCY-STOP mushroom pushbuttons, Ø 40 mm, with BKS key-operated switch</b> , (with 2 keys), lock No. S1, with positive latching according to ISO 13850, unlocking only possible using key	Red 	B	<b>3SB35 00-1LA20</b>
 Mushroom diameter 40 mm, with O.M.R. key-operated switch	<b>EMERGENCY-STOP mushroom pushbuttons, Ø 40 mm, with O.M.R. key-operated switch</b> (with 2 keys), lock No. 73037, with positive latching according to ISO 13850, unlocking only possible using key	Red 	B	<b>3SB35 00-1MA20</b>

For BKS and CES special locks, see catalog IC 10.

1) Also available without holder. Supplement Order No. with "-Z" and quote order code "B01". Price reduction approx. 1.70





2) The yellow backing plates must be ordered separately, see Accessories.

# 3SB3 Pushbuttons and indicator lights, 22 mm













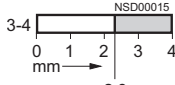

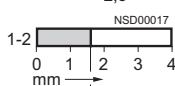

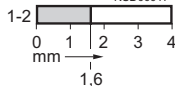
## Components for actuators and indicators

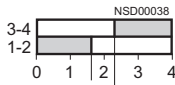
### Contact blocks and lampholders

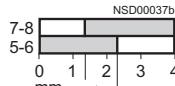
#### Selection and ordering data

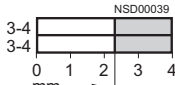
Version	Diagram	Operating travel	DT	Screw terminals	DT	Spring-type terminals
		 Contact closed  Contact open				
				Order No.		Order No.

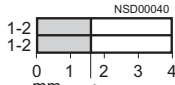
#### Contact blocks for front plate mounting

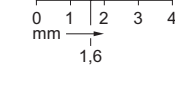
Image	Model	Description	Diagram	Operating travel	DT	Order No.	DT	Order No.	
	3SB34 00-0B	<b>Contact blocks with one contact</b>							
		• Mounting depth: 50 mm							
		1 NO		3-4		B	3SB34 00-0B	B	3SB34 03-0B
	3SB34 00-0BA	1 NO with gold-plated contacts							
		1 NC		1-2		B	3SB34 00-0C	B	3SB34 03-0C
		1 NC with gold-plated contacts							
	3SB34 00-0M	• With mounting monitoring contact <sup>2)</sup> , mounting depth 63 mm							
		1 NC		1-2		B	3SB34 00-0M	B	3SB34 03-0M
	3SB34 00-0A	<b>Contact blocks with 2 contacts</b>							
		Mounting depth 63 mm (including unit labeling plate)							
		1 NO + 1 NC		3-4		B	3SB34 00-0A	B	3SB34 03-0A
		1 NO + 1 NC with gold-plated contacts							
		1 NO leading + 1 NC lagging		7-8		B	3SB34 00-0H	B	3SB34 03-0H
		1 NO leading + 1 NC lagging with gold-plated contacts							
		2 NO		3-4		B	3SB34 00-0D	B	3SB34 03-0D
		2 NO with gold-plated contacts							
		2 NC		1-2		B	3SB34 00-0E	B	3SB34 03-0E
		2 NC with gold-plated contacts							
		2 NC with dust protection <sup>3)</sup>		1-2		C	3SB34 00-0Q	--	

1) Positive opening according to IEC 60947-5-1, Appendix K.  
 2) The NC contact opens automatically upon disconnection of the actuator. On delivery, the contact is open (= safe state). Activation (= NC contacts on the non-actuated control device are closed) takes place upon first-time actuation after the contact block is snapped onto the actuator. Unsuitable for mounting in 3SB38 enclosures.  
 3) With 3SB30 01-0CH dust protection shield

2

# 3SB3 Pushbuttons and indicator lights, 22 mm

## Components for actuators and indicators

### AS-Interface F adapters for EMERGENCY-STOP devices

#### Overview



EMERGENCY-STOP mushroom pushbutton with F adapter for bus connection







The AS-Interface F adapter is used to connect an EMERGENCY-STOP device according to ISO 13850 from the 3SB3 series to the AS-Interface bus system. The F adapter is suitable for control devices with mounting on front plates.

The F adapter has a safe AS-Interface 2E slave and is snapped from behind onto the EMERGENCY-STOP device (actuator). In the 2E/1A expanded version, an output is also available for actuating an indicator light with LED.

Depending on the version, screw terminals or spring-type terminals or the insulation piercing method are used for connecting to the AS-Interface bus cable. Addressing is performed using the AS-Interface connection or the integrated addressing socket.

Safety category 4 (SIL 3) is achieved with the adapter.

#### Selection and ordering data





Version	DT	Screw terminals 
		Order No.
 <p><b>AS-Interface F adapters for 3SB3 EMERGENCY-STOP actuators</b> For mounting on front plate</p> <ul style="list-style-type: none"> <li>• 2I</li> <li>• 2I/1O, with output for LED control</li> </ul>	<ul style="list-style-type: none"> <li>▶ <b>3SF5 402-1AA03</b></li> <li>▶ <b>3SF5 402-1AB03</b></li> </ul>	
3SF5 402-1AA03		
Version	DT	Spring-type terminals 
		Order No.
 <p><b>AS-Interface F adapters for 3SB3 EMERGENCY-STOP actuators</b> For mounting on front plate</p> <ul style="list-style-type: none"> <li>• 2I</li> <li>• 2I/1O, with output for LED control</li> </ul>	<ul style="list-style-type: none"> <li>▶ <b>3SF5 402-1AA04</b></li> <li>▶ <b>3SF5 402-1AB04</b></li> </ul>	
3SF5 402-1AA04		
Version	DT	Insulation piercing method 
		Order No.
 <p><b>AS-Interface F adapters for 3SB3 EMERGENCY-STOP actuators</b> For mounting on front plate</p> <ul style="list-style-type: none"> <li>• 2I</li> <li>• 2I/1O, with output for LED control</li> </ul>	<ul style="list-style-type: none"> <li>▶ <b>3SF5 402-1AA05</b></li> <li>▶ <b>3SF5 402-1AB05</b></li> </ul>	
3SF5 402-1AA05		

# 3SB3 Pushbuttons and indicator lights, 22 mm

## Accessories and spare parts

### Protective covers

#### Selection and ordering data

Version	Use	Color	DT	Order No.	
<b>Protective caps<sup>1)</sup>, degree of protection IP67</b>					
<i>Material: silicone</i>					
 3SB19 02-2BH	<b>Protective caps</b> For round version	Mushroom push-pull button, Ø 40 mm (plastic and metal)	Clear	B	<b>3SB19 02-2BH</b>
 3SB39 21-0BU		EMERGENCY-STOP mushroom pushbutton, Ø 40 mm (plastic and metal)	Clear	B	<b>3SB39 21-0BU</b>
<b>Protective collars for front plates</b>					
 3SB39 21-0AX	<b>Protective collars for EMERGENCY-STOP<sup>2)</sup></b> For round version	EMERGENCY-STOP mushroom pushbutton without lock	Yellow	▶	<b>3SB39 21-0AK</b>
		EMERGENCY-STOP mushroom pushbutton with key-operated switch	Gray	C	<b>3SB39 21-0AP</b>
			EMERGENCY-STOP mushroom pushbutton with key-operated switch	Yellow	B
 3SB39 21-0CG	<b>Protective collars for EMERGENCY-STOP for 5 padlocks<sup>2)</sup></b> For round version	3SB3...-1AA20 EMERGENCY- STOP mushroom pushbutton	Yellow	▶	<b>3SB39 21-0CG</b>

<sup>1)</sup> Not for mounting in 3SB38 enclosure with 3SB34 20 or 3SB34 23 contact blocks and lampholders for floor mounting.  
Not to be used with label holder.





<sup>2)</sup> The protective collar must only be used to protect against inadvertent actuating and must be fitted to allow unimpeded actuation of the EMERGENCY-STOP mushroom pushbutton.

# 3SB3 Pushbuttons and indicator lights, 22 mm

## Accessories and spare parts

### Miscellaneous accessories

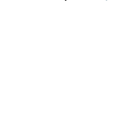
#### Selection and ordering data

Version	Use	Inscriptions	DT	Order No.
<b>Yellow name plates for EMERGENCY-STOP</b>				
<i>For use on front plates</i>				
	<b>Name plates, round</b> Self-adhesive, external diameter 60 mm, internal diameter 23 mm	EMERGENCY-STOP mushroom pushbutton (round version)	Blank	B B <b>3SB39 21-0DY</b>
	<b>Name plates, round</b> Self-adhesive, external diameter 80 mm, internal diameter 23 mm	EMERGENCY-STOP mushroom pushbutton (round version)	Blank	B B <b>3SB39 21-0AB</b>
			4 languages, de <sup>1)</sup> , en, it, es	B <b>3SB39 21-0BW</b>
			NOT-HALT	B <b>3SB39 21-0AC</b>
			NOT-AUS	B <b>3SB39 21-0CK</b>
	<b>Name plates, round</b> Self-adhesive, external diameter 80 mm, cutout 26 mm x 26 mm	EMERGENCY-STOP mushroom pushbuttons (square version)	EMERGENCY STOP	B <b>3SB39 21-0AD</b>
			ARRET D'URGENCE	B <b>3SB39 21-0AG</b>
			EMERGENZA	B <b>3SB39 21-0AN</b>
	<b>Name plates, round</b> Self-adhesive, external diameter 80 mm, cutout 26 mm x 26 mm	EMERGENCY-STOP mushroom pushbuttons (square version)	Blank	B <b>3SB39 41-0AB</b>
			NOT-HALT	B <b>3SB39 41-0AC</b>
			NOT-AUS	B <b>3SB39 41-0BX</b>
			EMERGENCY STOP	B <b>3SB39 41-0AD</b>
	<b>Name plates, round</b> 1 mm thick, external diameter 75 mm, internal diameter 22.5 mm	EMERGENCY-STOP mushroom pushbutton (round version)	Blank	B <b>3SB19 02-2BA</b>
			NOT-HALT	B <b>3SB19 02-2BB</b>
			NOT-AUS	B <b>3SB39 21-0CH</b>
	<b>Name plates, round</b> Self-adhesive, external diameter 60 mm, internal diameter 23 mm <sup>2)</sup>	EMERGENCY-STOP mushroom pushbutton (round version)	Blank	B <b>3SB39 21-0DA</b>
			NOT-HALT	B <b>3SB39 21-0DK</b>
			NOT-AUS	B <b>3SB39 21-0DC</b>
			EMERGENCY STOP	B <b>3SB39 21-0DD</b>

<sup>1)</sup> With German inscription "NOT-HALT".







<sup>2)</sup> For front panel thickness of max. 4 mm.

<sup>3)</sup> The illuminated label can also be operated through the AS-Interface F adapter (see page 2/110).

# 3SB3 Pushbuttons and indicator lights, 22 mm

## Accessories and spare parts

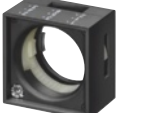
### Miscellaneous accessories

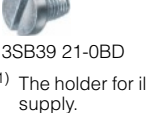
Version	Use	DT	Order No.
<b>Holders and pressure plates</b>			
 3SB39 01-0AB	<b>Holders</b> For snapping on 3 blocks <sup>1)</sup>	▶ Pushbuttons, push-pull buttons, mushroom pushbuttons with front plate mounting	<b>3SB39 01-0AB</b>
 3SB39 01-0AC	<b>Holders with pressure plate</b> For actuating the central contact block of 3 contact blocks	▶ Selector switches, key-operated switches and twin pushbuttons with front plate mounting	<b>3SB39 01-0AC</b>
 3SB39 01-0AW	<b>Pressure plates</b> For actuating the central contact block of 3 contact blocks	B Selector switches and key-operated switches for use on PCBs or with floor mounting	<b>3SB39 01-0AW</b>
<b>Holders for commanding and signaling elements<sup>2)</sup></b>			
 3SB39 31-0AA	<b>Holders</b> For plastic version, round	▶ As-supplied state for front panel thickness 1 ... 4 mm	<b>3SB39 31-0AA</b>
 3SB39 51-0AA	<b>Holders</b> For plastic version, square	B	<b>3SB39 51-0AA</b>
 3SB39 31-0AC	<b>Holders</b> For metal version, round	▶	<b>3SB39 31-0AC</b>
 3SB39 21-0BD	<b>Grounding screws</b> For grounding metal actuators for fitting in front plates made of non-conducting materials	B	<b>3SB39 21-0BD</b>

<sup>1)</sup> The holder for illuminated commanding devices is included in the scope of supply.

<sup>2)</sup> The matching holder for actuators and indicators is included in the scope of supply (exception: Order with order code "B01").

# 3SB3 Pushbuttons and indicator lights, 22 mm Enclosures

## General data

### Overview



Enclosures with standard and customized equipment

Enclosed pushbuttons and indicator lights are used as hand operated control devices for separately allocated control units and cabinets.

Enclosures with handle are available for suspension (e.g. for crane control units).

The enclosed pushbuttons and indicator lights are available with conventional controls as well as for connection to the AS-Interface bus system.

The following versions are available:

- Enclosure with standard fittings with 1 to 3 command points
- Enclosure with customized equipment with 1 to 6 command points
- Empty enclosures (individual parts must be ordered separately).

#### Customer-specific enclosures

On request enclosures with more than 6 command points can also be supplied with AS-Interface connection.

Use the configurator for selection.

### Application

The devices are climate-proof (KTW 24) according to EN ISO 6270-2 and suitable for stationary use (weather-protected) and for use in marine applications.

For AS-Interface enclosures see page 2/118.

#### Enclosures with standard fittings

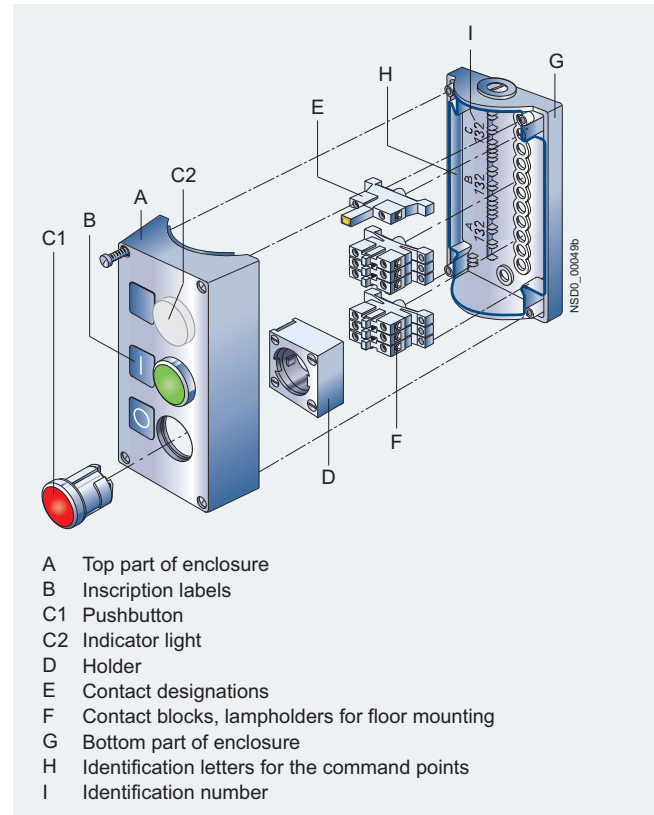

- A Top part of enclosure
- B Inscription labels
- C1 Pushbutton
- C2 Indicator light
- D Holder
- E Contact designations
- F Contact blocks, lampholders for floor mounting
- G Bottom part of enclosure
- H Identification letters for the command points
- I Identification number

#### Standards

IEC 60947-5-1, EN 60947-5-1



# 3SB3 Pushbuttons and indicator lights, 22 mm Enclosures

## Enclosures with standard fittings

### Overview

Enclosures with standard fittings are available with:

- 1 to 3 command points
- Operational voltage up to 400 V
- Vertical mounting type
- Plastic enclosures are equipped with plastic actuators and indicators, metal enclosures are equipped with metal actuators and indicators
- Contact blocks and lampholders for floor mounting (are snapped into the enclosure base). Screw terminals (box terminals) as standard; some versions also with spring-type terminals (Order No. ends with -0CC0).

The actuators/indicators are fixed with an enclosure nut. If required it can be disassembled with a 27 mm socket wrench or with a 3SX17 07 ring nut wrench.

Color of enclosure cover:

- Gray, RAL 7035, or
- Yellow, RAL 1004

Color of enclosure base:

- Black, RAL 9005

### Selection and ordering data

Equipment	Contact block function	Number of command points	DT	Screw terminals
				Order No.

#### Plastic enclosures with standard fittings

##### Cable entry top and bottom each 1 x M20



3SB38 01-0.F3

A = EMERGENCY-STOP mushroom pushbuttons, Ø 40 mm, with positive latching according to ISO 13850 and rotate-to-unlatch mechanism

- With yellow top part, without protective collar
 

1 NC	→ <sup>2)</sup>	1	B	<b>3SB38 01-0DG3</b>
2 NC	→ <sup>2)</sup>	1	B	<b>3SB38 01-0EG3</b>
- With yellow top part, with protective collar<sup>1)</sup>

1 NC	→ <sup>2)</sup>	1	B	<b>3SB38 01-0DF3</b>
2 NC	→ <sup>2)</sup>	1	B	<b>3SB38 01-0EF3</b>

<sup>1)</sup> The protective collar must only be used to protect against inadvertent actuating and must be fitted to allow unimpeded access to the EMERGENCY-STOP mushroom pushbutton.

<sup>2)</sup> Positive opening according to IEC 60947-5-1, Appendix K.

<sup>3)</sup> Only lampholder; order lamp separately.

Equipment	Contact block function	Number of command points	DT	Screw terminals
				Order No.

Spring-type terminals<sup>3)</sup>

#### Metal enclosures with standard fittings

##### Cable entry top and bottom each 1 x M20



3SB38 01-2.F3

A = EMERGENCY-STOP mushroom pushbuttons, Ø 40 mm, with positive latching according to ISO 13850 and rotate-to-unlatch mechanism

- With yellow top part, without protective collar
 

1 NC	→ <sup>2)</sup>	1	B	<b>3SB38 01-2DG3</b>
2 NC	→ <sup>2)</sup>	1	B	<b>3SB38 01-2EG3</b>
- With M12 socket
 

2 NC	→ <sup>2)3)</sup>	1	C	<b>3SB38 01-2EG10-0CC0</b>
------	-------------------	---	---	----------------------------
- With yellow top part, with protective collar<sup>1)</sup>

1 NC	→ <sup>2)</sup>	1	B	<b>3SB38 01-2DF3</b>
2 NC	→ <sup>2)</sup>	1	B	<b>3SB38 01-2EF3</b>



3SB38 01-2EB30

A = EMERGENCY-STOP mushroom pushbuttons, Ø 60 mm, with positive latching according to ISO 13850 and rotate-to-unlatch mechanism

- With yellow top part, with protective collar for 5 padlocks
 

2 NC	→ <sup>2)</sup>	1	B	<b>3SB38 01-2EA30</b>
2 NC	→ <sup>2)3)</sup>	1	B	<b>3SB38 01-2EA30-0CC0</b>

<sup>1)</sup> The protective collar must only be used to protect against inadvertent actuating and must be fitted to allow unimpeded access to the EMERGENCY-STOP mushroom pushbutton.

<sup>2)</sup> Positive opening according to IEC 60947-5-1, Appendix K.

<sup>3)</sup> -0CC0: Contact blocks with spring-type terminals.

# 3SB3 Pushbuttons and indicator lights, 22 mm Enclosures

## Empty enclosures

### Selection and ordering data

Version	Number of command points	DT	Order No.
---------	--------------------------	----	-----------

#### Empty enclosures, plastic



3SB38 02-0AA3

**Cable entry top and bottom**  
each 1 x M20 for 1 to 3 command points,  
each 1 x M25 for 4 and 6 command points

For contact blocks, lampholders and accessories with snap-on floor mounting, also single-pole front plate blocks can be used (switching state is maintained upon opening), with gray top part

1	B	<b>3SB38 01-0AA3</b>
2	B	<b>3SB38 02-0AA3</b>
3	B	<b>3SB38 03-0AA3</b>
4	B	<b>3SB38 04-0AA3</b>
6	B	<b>3SB38 06-0AA3</b>



3SB38 01-0AB3

For EMERGENCY-STOP, for contact blocks, lampholders and accessories with snap-on floor mounting, also single-pole front plate blocks can be used (switching state is maintained upon opening)

- With yellow top part, without protective collar

1	B	<b>3SB38 01-0AB3</b>
---	---	----------------------

- With yellow top part, with protective collar<sup>1)</sup>

1	B	<b>3SB38 01-0AD3</b>
---	---	----------------------

#### Empty enclosures, metal



3SB38 04-2AA3

**Cable entry top and bottom**  
each 1 x M20 for 1 to 3 command points,  
each 1 x M25 for 4 and 6 command points

For contact blocks, lampholders and accessories with snap-on floor mounting, also single-pole front plate blocks can be used (switching state is maintained upon opening), with gray top part

1	B	<b>3SB38 01-2AA3</b>
2	B	<b>3SB38 02-2AA3</b>
3	B	<b>3SB38 03-2AA3</b>
4	B	<b>3SB38 04-2AA3</b>
6	B	<b>3SB38 06-2AA3</b>



3SB38 01-2AB3

For EMERGENCY-STOP, for contact blocks, lampholders and accessories with snap-on floor mounting, also single-pole front plate blocks can be used (switching state is maintained upon opening)

- With yellow top part, without protective collar

1	B	<b>3SB38 01-2AB3</b>
---	---	----------------------

- With yellow top part, with protective collar<sup>1)</sup>

1	B	<b>3SB38 01-2AD3</b>
---	---	----------------------



3SB38 01-2AD3

- With gray top part, with protective collar

1	B	<b>3SB38 01-2AE3</b>
---	---	----------------------

- With yellow top part, with protective collar for 3 padlocks, for mushroom Ø 40 mm, can be locked (BKS, CES, O.M.R.)

1	B	<b>3SB38 01-2EC3</b>
---	---	----------------------



3SB38 01-2EC3

<sup>1)</sup> The protective collar must only be used to protect against inadvertent actuating and must be fitted to allow unimpeded access to the EMERGENCY-STOP mushroom pushbutton.

# 3SB3 Pushbuttons and indicator lights, 22 mm Enclosures

## Contact blocks and lampholders

### Selection and ordering data

For self-equipping of the enclosures

Version	Rated voltage/ Diagram	Operating travel/color	DT	Screw terminals
		<input type="checkbox"/> Contact closed <input type="checkbox"/> Contact open		Order No.

#### Contact blocks for floor mounting



##### Contact blocks with one contact

1 NO  
1 NO with gold-plated contacts

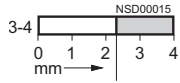

▶ **3SB34 20-0B**  
▶ **3SB34 20-0BA**

1 NC  
1 NC with gold-plated contacts

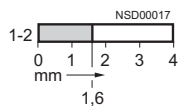

▶ **3SB34 20-0C**  
▶ **3SB34 20-0CA**

Version	Rated voltage/ Diagram	Operating travel/color	DT	Spring-type terminals
		<input type="checkbox"/> Contact closed <input type="checkbox"/> Contact open		Order No.

#### Contact blocks for floor mounting



##### Contact blocks with one contact

1 NO  
1 NO with gold-plated contacts

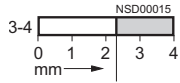

▶ **3SB34 23-0B**  
▶ **3SB34 23-0BA**

1 NC  
1 NC with gold-plated contacts

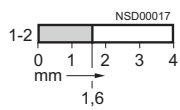

▶ **3SB34 23-0C**  
▶ **3SB34 23-0CA**

<sup>1)</sup> Positive opening according to IEC 60947-5-1, Appendix K.

2

# 3SB3 Pushbuttons and indicator lights, 22 mm

## Enclosures for AS-Interface

### General data

### Overview



AS-Interface enclosure with customized equipment

Distributed command devices of the 3SB3 series can be quickly connected to the AS-Interface using AS-Interface enclosures. Using suitable components you can make your own enclosures with integrated AS-Interface or flexibly modify existing enclosures.

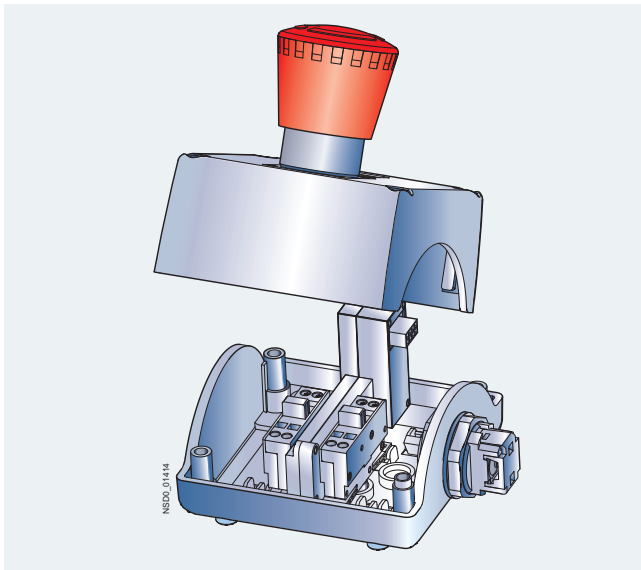

EMERGENCY-STOP enclosure

### Enclosures

Color of enclosure cover:

- Gray, RAL 7035, or
- Yellow, RAL 1004, for EMERGENCY-STOP.

Color of enclosure base:

- Black, RAL 9005

### Installation of AS-Interface slaves

The following slave types are available for connecting the command points:

- Slave in A/B technology with 4 inputs and 3 outputs
- Slave with 4 inputs and 4 outputs
- F slave with 2 safe inputs for EMERGENCY-STOP

The following table shows the maximum number of equippable slaves:

Enclosures for	Number of slaves for enclosures without EMERGENCY-STOP	Number of slaves for enclosures with EMERGENCY-STOP
1 command point	Not available	1 x F slave
2 command points	1 x slave 4I/4O or 4I/3O	Not available
3 command points	1 x slave 4I/4O or 4I/3O	1 x slave 4I/4O or 4I/3O + 1 x F slave
4 command points	2 x slave 4I/4O or 4I/3O <sup>1)</sup>	2 x slave 4I/4O or 4I/3O + 1 x F slave <sup>1)</sup>
6 command points	2 x slave 4I/4O or 4I/3O	2 x slave 4I/4O or 4I/3O + 1 x F slave

<sup>1)</sup> For metal enclosures with 4 command points, only 1 x slave 4I/4O or 4I/3O is possible.

### Connection

One set of links is required in each case to connect a slave to contact blocks, to lampholders and to the connection element.

The connection elements are mounted in the front-end cable glands and are used for connection of the AS-Interface or for bringing unused inputs or outputs out of the enclosure.

For connection to the AS-Interface bus there is a choice of the following options:

- Terminal for shaped AS-Interface cable. The cable is contacted by the insulation piercing method and routed past the enclosure on the outside (possible only with plastic enclosure).
- Cable gland for the shaped AS-Interface cable or round cable. The cable is routed into the enclosure (preferable for metal enclosure).
- Connection using M12 plug.

If less than all inputs/outputs of the installed slaves in an enclosure are used for connecting the command devices, free inputs and outputs can be routed on request to the outside through an M12 socket on the top or bottom side of the enclosure.

To supply inputs with power, the S+ connection of the must be assigned to the socket, for outputs the OUT- connection must be assigned.

Addressing is performed using the AS-Interface connections or the integrated addressing socket. An external power supply is not required.



### Customized enclosures (selection by configurator)

To order customized 3SF58 AS-Interface enclosures with the 3SB3 control devices, use the 3SB/3SF configurator to select the blocks for equipping. An electronic order form will be generated for the additional options.

# 3SB3 Pushbuttons and indicator lights, 22 mm Enclosures for AS-Interface

## AS-Interface enclosures with standard fittings

### Selection and ordering data

Equipping options (A, B, C = identification letters of the command points)		No. of com- mand points	DT	Order No.	
<b>AS-Interface enclosures, plastic</b>					
 3SF5 811-0AA08	<b>With M12 top connector</b>				
	A = EMERGENCY-STOP mushroom pushbuttons, with rotate-to-unlatch mechanism, 1 NC, 1 NC, yellow enclosure top		1	B	<b>3SF5 811-0AA10</b>
	<b>With terminal for insulation piercing method at top</b>				
A = EMERGENCY-STOP mushroom pushbuttons, with rotate-to-unlatch mechanism, 1 NC, 1 NC					
• Yellow enclosure top		1	A	<b>3SF5 811-0AA08</b>	
• Yellow enclosure top, with protective collar		1	A	<b>3SF5 811-0AB08</b>	
<b>AS-Interface enclosures, metal</b>					
 3SF5 811-2AB08	<b>With M12 top connector</b>				
	A = EMERGENCY-STOP mushroom pushbuttons, with rotate-to-unlatch mechanism, 1 NC, 1 NC				
	• Yellow enclosure top		1	C	<b>3SF58 11-2AA10</b>
• Yellow enclosure top, with protective collar		1	C	<b>3SF58 11-2AB10</b>	
<b>With cable gland at top</b>					
A = EMERGENCY-STOP mushroom pushbuttons, with rotate-to-unlatch mechanism, 1 NC, 1 NC					
• Yellow enclosure top		1	A	<b>3SF5 811-2AA08</b>	
• Yellow enclosure top, with protective collar		1	A	<b>3SF5 811-2AB08</b>	

# 3SB3 Pushbuttons and indicator lights, 22 mm

## Enclosures for AS-Interface











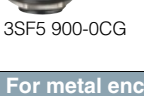

### Components for AS-Interface enclosures

#### Selection and ordering data







##### For self-equipping of the enclosures

Version	Number of command points	DT	Order No.
---------	--------------------------	----	-----------

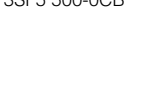
#### For plastic enclosures

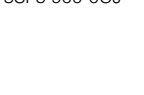
AS-Interface slaves			
 3SF5 500-0BA	F slave, 2 safe inputs, for plastic enclosure, EMERGENCY-STOP, without protective collar	1 ... 6	A <b>3SF5 500-0BA</b>
 3SF5 500-0DA	F slave, 2 safe inputs, for plastic or metal enclosure, EMERGENCY-STOP, with protective collar	1	A <b>3SF5 500-0DA</b>
 3SF5 500-0BB	A/B slave, 4I/3O for plastic enclosure	2 ... 6	A <b>3SF5 500-0BB</b>
 3SF5 500-0BC	Slave, 4I/4O, for plastic enclosure	2 ... 6	A <b>3SF5 500-0BC</b>
Sets of links			
 3SF5 900-0BA	For F slave		A <b>3SF5 900-0BA</b>
 3SF5 900-0BB	For slave 4I/4O or A/B slave 4I(3O)		A <b>3SF5 900-0BB</b>
Connection elements			
 3SF5 900-0CA	For AS-Interface shaped cable, connection by insulation piercing method, for plastic enclosure	1 ... 3	A <b>3SF5 900-0CA</b>
 3SF5 900-0CB	For AS-Interface connection using M12 plug, for plastic enclosure	4 ... 6	B <b>3SF5 900-0CB</b>
 3SF5 900-0CC	For bringing out unused inputs/outputs through an M12 socket, for plastic enclosure	1 ... 3	B <b>3SF5 900-0CC</b>
 3SF5 900-0CE	For AS-Interface shaped cable, cable is routed into the enclosure, for plastic or metal enclosure	4 ... 6	B <b>3SF5 900-0CE</b>
 3SF5 900-0CF	For AS-Interface shaped cable, cable is routed into the enclosure, for plastic or metal enclosure	1 ... 3	A <b>3SF5 900-0CF</b>
 3SF5 900-0CG	For round cable, cable is routed into the enclosure, for plastic or metal enclosure	4 ... 6	A <b>3SF5 900-0CG</b>
 3SF5 900-0CH	For round cable, cable is routed into the enclosure, for plastic or metal enclosure	1 ... 3	A <b>3SF5 900-0CH</b>
 3SF5 900-0CJ	For round cable, cable is routed into the enclosure, for plastic or metal enclosure	4 ... 6	A <b>3SF5 900-0CJ</b>
 3SF5 900-0CK	For round cable, cable is routed into the enclosure, for plastic or metal enclosure	1 ... 3	A <b>3SF5 900-0CK</b>

#### For metal enclosures

AS-Interface slaves			
 3SF5 500-0CA	F slave, 2 safe inputs, for metal enclosure, EMERGENCY-STOP, without protective collar	1 ... 6	A <b>3SF5 500-0CA</b>
 3SF5 500-0DA	F slave, 2 safe inputs, for plastic or metal enclosure, EMERGENCY-STOP, with protective collar	1	A <b>3SF5 500-0DA</b>
 3SF5 500-0CB	A/B slave, 4I/3O, for metal enclosure	2 ... 6	A <b>3SF5 500-0CB</b>
 3SF5 500-0CC	Slave, 4I/4O, for metal enclosure	2 ... 6	A <b>3SF5 500-0CC</b>
Sets of links			
 3SF5 900-0BA	For F slave		A <b>3SF5 900-0BA</b>
 3SF5 900-0BB	For slave 4I/4O or A/B slave 4I(3O)		A <b>3SF5 900-0BB</b>
Connection elements			
 3SF5 900-2CC	For AS-Interface connection using M12 plug, for metal enclosure	1 ... 3	B <b>3SF5 900-2CC</b>
 3SF5 900-2CD	For bringing out unused inputs/outputs through an M12 socket, for metal enclosure	4 ... 6	B <b>3SF5 900-2CD</b>
 3SF5 900-2CE	For AS-Interface shaped cable, cable is routed into the enclosure, for plastic or metal enclosure	1 ... 3	B <b>3SF5 900-2CE</b>
 3SF5 900-2CF	For AS-Interface shaped cable, cable is routed into the enclosure, for plastic or metal enclosure	4 ... 6	B <b>3SF5 900-2CF</b>
 3SF5 900-0CG	For round cable, cable is routed into the enclosure, for plastic or metal enclosure	1 ... 3	A <b>3SF5 900-0CG</b>
 3SF5 900-0CH	For round cable, cable is routed into the enclosure, for plastic or metal enclosure	4 ... 6	A <b>3SF5 900-0CH</b>
 3SF5 900-0CJ	For round cable, cable is routed into the enclosure, for plastic or metal enclosure	1 ... 3	A <b>3SF5 900-0CJ</b>
 3SF5 900-0CK	For round cable, cable is routed into the enclosure, for plastic or metal enclosure	4 ... 6	A <b>3SF5 900-0CK</b>

## Plastic and metal enclosures

## Overview



Two-hand operation console with metal enclosure

## Equipment

The two-hand operation consoles are pre-equipped with 3SB3 command devices. In the case of plastic enclosures the command points are equipped as standard with actuators and indicators made of plastic, in the case of metal enclosures they are equipped with actuators and indicators made of metal.

The standard equipment comprises:

- 2 black mushroom pushbuttons, Ø 40 mm, 1 NO + 1 NC, Order No. 3SB30 00-1GA11 or 3SB35 00-1GA11
- 1 red EMERGENCY-STOP mushroom pushbutton according to ISO 13850, Ø 40 mm, with positive latching, 2 NC, Order No. 3SB30 00-1HA20 or 3SB35 00-1HA20.

The plastic version can be retrofitted with up to 8 customized command points. The surface of the console has premachined breaking points for this purpose.

## Application

The two-hand operation consoles are required for use with machines and systems that have hazardous areas, in order to direct both hands of the operator to one position.

Operator panels are primarily used on presses, stamping machines, printing presses and paper converting machines, in the chemical industry and in the rubber and plastics industries.



The control command is given by pressing the two mushroom pushbuttons on the sides simultaneously (within 0.5 s of each other) and must be maintained for as long as a hazard exists.

For the further processing of control commands, suitable evaluation units are used, e.g. 3TK28 3 safety relays (see Catalog IC 10, Safety Relays in chapter 7).

## Standards

The two-hand operation consoles comply with the requirements of EN 574.

## Selection and ordering data

Version	DT	Order No.
<b>Metal enclosures, degree of protection IP65</b>		
 <p><b>Two-hand operation consoles, metal enclosure</b></p> <ul style="list-style-type: none"> <li>• With standard fittings</li> <li>• With standard fittings and 4 additional holes for 22.5 mm command devices<sup>1)</sup></li> <li>• Empty enclosure, unequipped</li> </ul>	B	<b>3SB38 63-4BB</b>
	B	<b>3SB38 63-4BA</b>
	B	<b>3SB38 63-4BC</b>
<b>Plastic enclosures, degree of protection IP65</b>		
 <p><b>Two-hand operation consoles, plastic enclosure</b></p> <p>With standard fittings and premachined breaking points for 8 additional 22.5 mm<sup>1)</sup> command devices, with holes for metric cable glands</p>	B	<b>3SB38 63-1BB3</b>
<b>Accessories</b>		
 <p><b>Stands for two-hand operation consoles</b></p> <p>With holes for metric cable glands</p>	B	<b>3SB39 01-0AQ3</b>

3SB39 01-0AQ

<sup>1)</sup> See 3SB3 pushbuttons and indicator lights.

# 3SE7, 3SF2 cable-operated switches

## 3SE7 metal enclosures

### Overview



Cable-operated switches

The cable-operated switches are used for monitoring or for EMERGENCY-STOP devices on particularly endangered system sections.

As the effective range of a cable-operated switch is only limited by the length of the trip-wire, large systems can also be protected. Cable-operated switches (requiring pulling at both ends) and conveyor belt unbalance trackers are used primarily for monitoring very long belt systems.

### Contact blocks

The switches for wire lengths up to 50 m are supplied with 1 NO + 1 NC or 2 NC contacts and those up to 75 m with 1 NO + 3 NC contacts. The switches for wire lengths from 2 × 75 m and the conveyor belt unbalance protection device are supplied with 2 NO + 2 NC contacts.

The NC contacts of the cable-break or cable-pull signaling are positive opening. The NO contact can be used, for example, for signaling purposes.

### Free position and indication

Cable-operated switches with one-side operation are held in free position by the pre-tension on the turnbuckle.

On switches with interlocking, with a pretensioned cable, the locking must be deactivated beforehand in order to return the cable-operated switch to its original position.

The cable-operated switch and the conveyor belt unbalance tracker can be supplied optionally with a factory-fitted LED (red, 24 V DC). This light in innovative chip-on-board technology allows the operating state of the switch to be visible at a distance of at least 50 m.

### Application

#### Standards

The switches are equipped with positive latching and positive NC contacts and are thus suitable for operation in EMERGENCY-STOP devices according to EN ISO 13850.

### Technical specifications

Type	3SE7 120	3SE7 150	3SE7 140	3SE7 141	3SE7 160	3SE7 310
<b>General data</b>						
<b>Standards</b>	IEC 60947-5-1, EN 60947-5-1; IEC 60204-1, EN 60204-1; EN ISO 13850					
<b>Approvals</b>	UL/CSA					
<b>Electrical design</b>	Contacts electrically isolated from each other					
<b>Electrical load</b>	<ul style="list-style-type: none"> <li>• 2-pole, at AC-15</li> <li>• 3-pole, at AC-15</li> <li>• 4-pole, at AC-15</li> <li>• Min.</li> </ul>					
	400 V AC, 6 A		400 V AC, 6 A	250 V AC, 2 A	400 V AC, 6 A	--
	250 V AC, 2 A		--	--	--	--
	--		--	--	400 V AC, 6 A	400 V AC, 6 A
	24 V AC/DC, 10 mA					
<b>Short-circuit protection</b>	A	6 (slow)				
<b>Mechanical endurance</b>	> 1 million operating cycles					
<b>Contact material</b>	Fine silver					
<b>Operation</b>	By pulling or breaking of wire					
<b>Wire length, maximum</b>	m	10	25	50	75	2 × 75
<b>Distance between wire supports, max.</b>	m	2.5	3	5		--
<b>Enclosures</b>						
<b>Enclosure material</b>	GD Al alloy, coated (color), dark black RAL 9005					
<b>Cover</b>	Shock-resistant thermoplast					
<b>Degree of protection</b> acc. to EN 60529	IP65			IP67	IP65	
<b>Ambient temperature</b>	°C	-25 ... +70				
<b>Mounting</b>	Designed for M5					
<b>Fixing spacing</b>	mm	30 and 40				
<b>Cable entry</b>	2 × (M20 × 1.5)		1 × (M16 × 1.5)	3 × (M20 × 1.5)	2 × (M25 × 1.5)	
<b>Connection type</b>	Screw terminals M3.5, self-lifting clamp terminal					



## Selection and ordering data

Version	Wire length m	Contacts	DT	Order No.		
<b>Cable-operated switches</b>						
 3SE7 120-1BH00	<b>Metal enclosures, IP65</b> (cover made of molded plastic)	10				
		<ul style="list-style-type: none"> <li>Without latching, only cable pull monitoring</li> </ul>	1 NO + 1 NC	→ <sup>1)</sup> A	<b>3SE7 120-2DD01</b>	
		<ul style="list-style-type: none"> <li>With latching and button reset</li> <li>- With yellow lid</li> </ul>	2 NC	→ <sup>1)</sup> A	<b>3SE7 120-1BF00</b>	
				1 NO + 2 NC	→ <sup>1)</sup> A	<b>3SE7 120-1BH00</b>
 3SE7 150-1BD00 3SE7 150-1BH00	<b>Metal enclosures, IP65</b> (cover made of molded plastic), with dust protection and alignment window	25				
		<ul style="list-style-type: none"> <li>Without latching</li> </ul>	1 NO + 1 NC	→ <sup>1)</sup> A	<b>3SE7 150-2DD00</b>	
		<ul style="list-style-type: none"> <li>With latching and button reset</li> </ul>	1 NO + 1 NC	→ <sup>1)</sup> A	<b>3SE7 150-1BD00</b>	
			2 NC	→ <sup>1)</sup> A	<b>3SE7 150-1BF00</b>	
		<ul style="list-style-type: none"> <li>- With yellow lid</li> <li>With latching and key unlatching</li> </ul>	1 NO + 2 NC	→ <sup>1)</sup> B	<b>3SE7 150-1BH00</b>	
		1 NO + 1 NC	→ <sup>1)</sup> B	<b>3SE7 150-1CD00</b>		
 3SE7 150-1BD04	<b>Metal enclosures, IP65</b> (cover made of molded plastic), with dust protection and alignment window, with LED, red, 24 V DC	25				
		<ul style="list-style-type: none"> <li>Without latching</li> <li>With latching and button reset</li> </ul>	1 NO + 1 NC	→ <sup>1)</sup> B	<b>3SE7 150-2DD04</b>	
				1 NO + 1 NC	→ <sup>1)</sup> B	<b>3SE7 150-1BD04</b>
 3SE7 140-1B.00	<b>Metal enclosures, IP65</b> (cover made of molded plastic), with dust protection	50				
		<ul style="list-style-type: none"> <li>With latching and button reset</li> </ul>	1 NO + 1 NC	→ <sup>1)</sup> A	<b>3SE7 140-1BD00</b>	
			2 NC	→ <sup>1)</sup> B	<b>3SE7 140-1BF00</b>	
		<ul style="list-style-type: none"> <li>In addition with LED, red, 24 V DC</li> <li>With latching and key unlatching</li> </ul>	1 NO + 1 NC	→ <sup>1)</sup> B	<b>3SE7 140-1BD04</b>	
				1 NO + 1 NC	→ <sup>1)</sup> B	<b>3SE7 140-1CD00</b>
 3SE7 141-1EG10	<b>Metal enclosures, IP67</b> (cover made of molded plastic), with EMERGENCY-STOP mushroom, rotate-to-unlatch mechanism	75	1 NO + 3 NC	→ <sup>1)</sup> A	<b>3SE7 141-1EG10</b>	
 3SE7 160-1AE00	<b>Metal enclosures, IP65</b> With actuation on both sides	2 × 75				
			<ul style="list-style-type: none"> <li>With latching and button reset</li> </ul>	2 NO + 2 NC	→ <sup>1)</sup> A	<b>3SE7 160-1AE00</b>
				1 NO + 1 NC	→ <sup>1)</sup> B	<b>3SE7 160-1BD00</b>
	<ul style="list-style-type: none"> <li>In addition with LED, red, 24 V DC</li> </ul>	2 NO + 2 NC	→ <sup>1)</sup> B	<b>3SE7 160-1AE04</b>		

1) Positive opening according to IEC 60947-5-1, Appendix K.

# 3SE7, 3SF2 cable-operated switches

## 3SE7 metal enclosures

Version	Wire length m	Contacts	DT	Order No.
---------	------------------	----------	----	-----------

### Conveyor belt unbalance trackers



#### Metal enclosures, IP65

- With latching and button reset
- In addition with LED, red, 24 V DC

2 NO + 2 NC →<sup>1)</sup> B  
2 NO + 2 NC →<sup>1)</sup> B

**3SE7 310-1AE00**  
**3SE7 310-1AE04**

3SE7 310-1AE00

<sup>1)</sup> Positive opening according to IEC 60947-5-1, Appendix K.

## Accessories

### Configuration of the cable-operated switches

#### Short lengths of wire up to 25 m

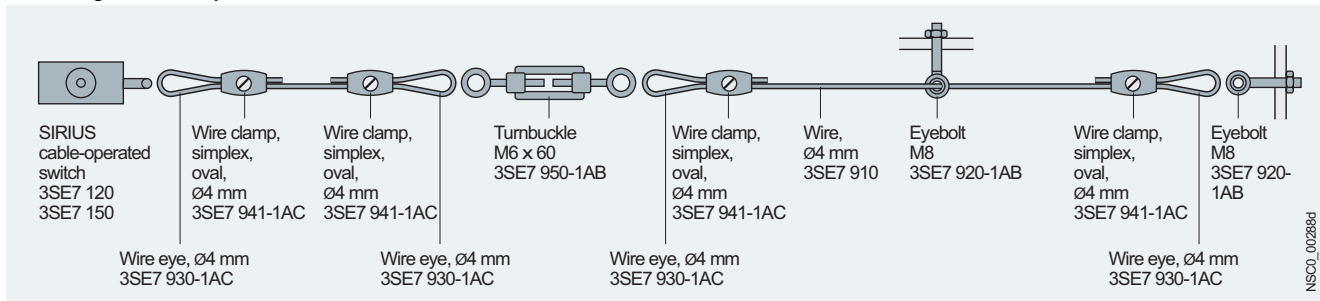

#### Long lengths of wire up to 50 m

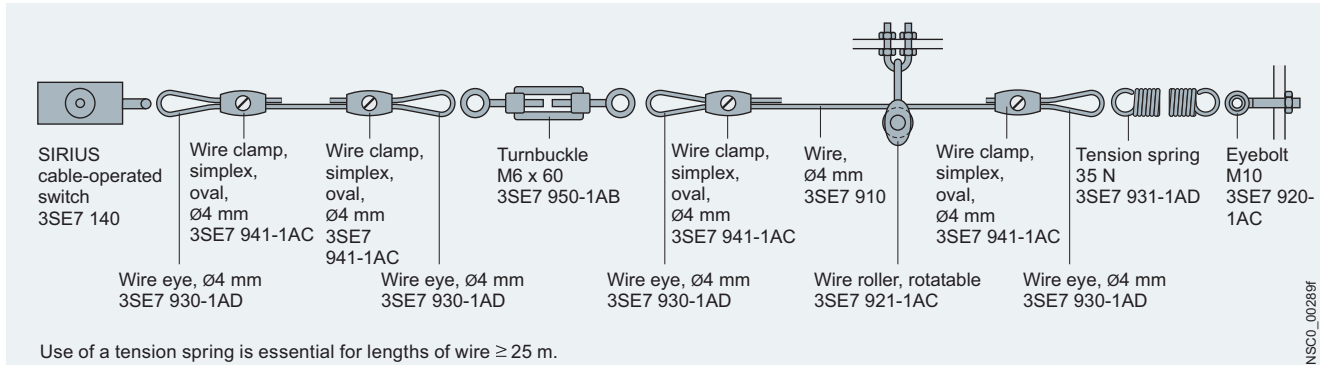

Use of a tension spring is essential for lengths of wire  $\geq 25$  m.

#### Pulling from both sides up to 2 x 75 m

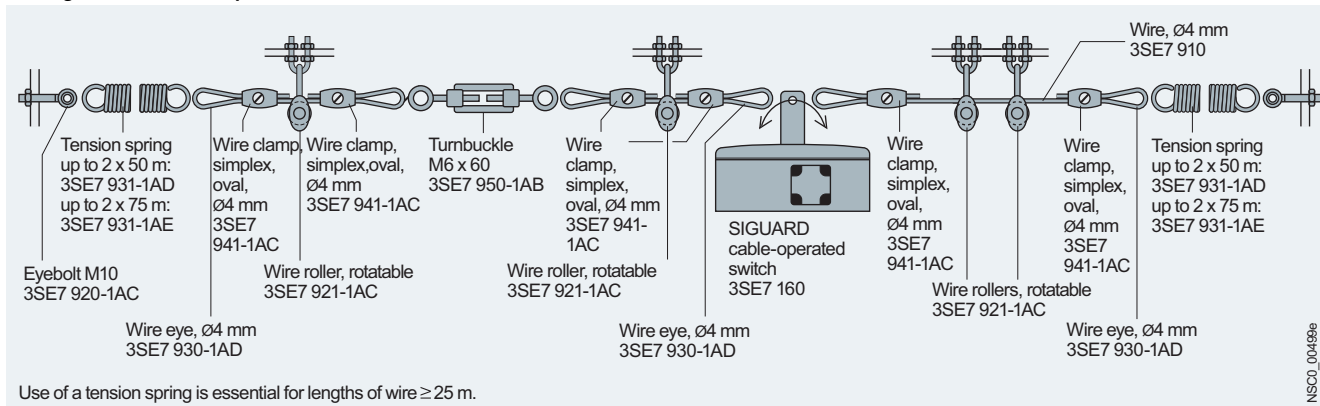









Use of a tension spring is essential for lengths of wire  $\geq 25$  m.

#### Note:

Large temperature fluctuations require corresponding compensation springs. For reliable connection the PVC sheath must be removed from the clamping area of the steel bowden wire.

Bowden wire supports must be used at the recommended intervals.

Version	Wire length/ diameter	DT	Order No.	
<b>Trip-wires with fixing</b>				
	<b>Steel wires</b> , with red plastic sheath, Ø 4 mm <sup>1)</sup>	10 m	A	<b>3SE7 910-3AA</b>
		15 m	A	<b>3SE7 910-3AB</b>
		20 m	A	<b>3SE7 910-3AC</b>
		50 m	A	<b>3SE7 910-3AH</b>
	<b>Wire clamps</b> , galvanized white			
	• Oval	2 × Ø 4 mm	A	<b>3SE7 941-1AC</b>
	• Simplex (1 set = 4 units)	2 × Ø 4 mm	A	<b>3SE7 943-1AC</b>
	• Duplex (1 set = 4 units)	2 × Ø 4 mm	A	<b>3SE7 944-1AC</b>
	• Single (1 set = 4 units)	2 × Ø 4 mm	A	<b>3SE7 942-1AA</b>
	<b>Tension springs</b> (zinc-plated) to maintain the counter tension			
	• 13 N		A	<b>3SE7 931-1AB</b>
	• 35 N, for bowden wires up to 50 m		A	<b>3SE7 931-1AD</b>
	• > 35 N, for bowden wires up to 2 × 75 m		B	<b>3SE7 931-1AE</b>
	<b>Wire rollers</b> for changing the direction of the wire, rotatable	Ø 4 mm	A	<b>3SE7 921-1AC</b>
	<b>Fixtures for the wire rollers</b> (incl. fixing nuts)		A	<b>3SE7 921-1AA</b>
	<b>Wire eyes</b> for changes in wire direction and improved power transmission at the fixing points (1 set = 4 units)	Ø 4 mm	A	<b>3SE7 930-1AD</b>
	<b>Eyebolts</b> for fixing the wire			
	• Including M8 nut		A	<b>3SE7 920-1AB</b>
	• Including M10 nut		A	<b>3SE7 920-1AC</b>
	<b>Turnbuckles</b> for precise adjustment of the pretension			
	• M6 x 60		A	<b>3SE7 950-1AB</b>
	• M6 x 110		A	<b>3SE7 950-1AD</b>
<b>Spare parts</b>				
	<b>LED lamps</b> , red 24 V DC 25 mm diameter; for M20 x 1.5 connection		C	<b>3SX3 235</b>

<sup>1)</sup> Diameter including casing; the diameter of the steel wire is 3.2 mm.

# 3SE7, 3SF2 cable-operated switches

## 3SF2 cable-operated switches for AS-Interface

### Overview

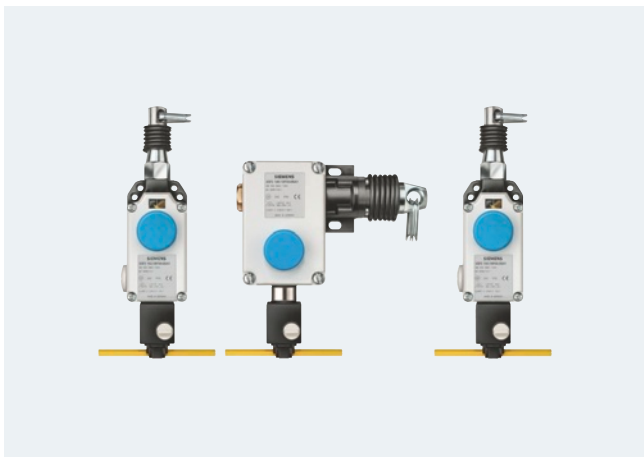

Cable-operated switch with AS-Interface adapter

AS-Interface cable-operated switches can now be directly connected via the standard AS-Interface with safety-oriented communication.

The safety functions no longer have to be conventionally wired up.

### Application

SIRIUS cable-operated switches are used for monitoring or for EMERGENCY-STOP devices on particularly endangered system sections.

As the effective range of a cable-operated switch is only limited by the length of the trip-wire, large systems can also be protected.

### Standards

The switches with positive latching are suitable for operation in EMERGENCY-STOP devices in according to ISO 13850. They can achieve up to category 4 according to EN ISO 13849-1 (EN 954-1) or SIL 3 according to IEC 61508.

### Selection and ordering data

Version	Basic switches	DT	Order No.
---------	----------------	----	-----------

#### ASisafe cable-operated switches

##### Metal enclosures, IP65

(cover made of molded plastic), with dust protection, latching acc. to ISO 13850, with button reset, 2 NC contacts

- For wire lengths up to 10 m, with alignment window

3SE7 120-1BF00 → C

**3SF2 120-1BF00-0BA1**



3SF2 120-1BF00-0BA1

- For wire lengths up to 25 m, with alignment window

3SE7 150-1BF00 → C

**3SF2 150-1BF00-0BA1**



3SF2 150-1BF00-0BA1

- For wire lengths up to 50 m

3SE7 140-1BF00 → B

**3SF2 140-1BF00-0BA1**



3SF2 140-1BF00-0BA1

→ Positive opening according to IEC 60947-5-1, Appendix K.

## Overview

The 8WD4 signaling columns are flexible in design and versatile in use.

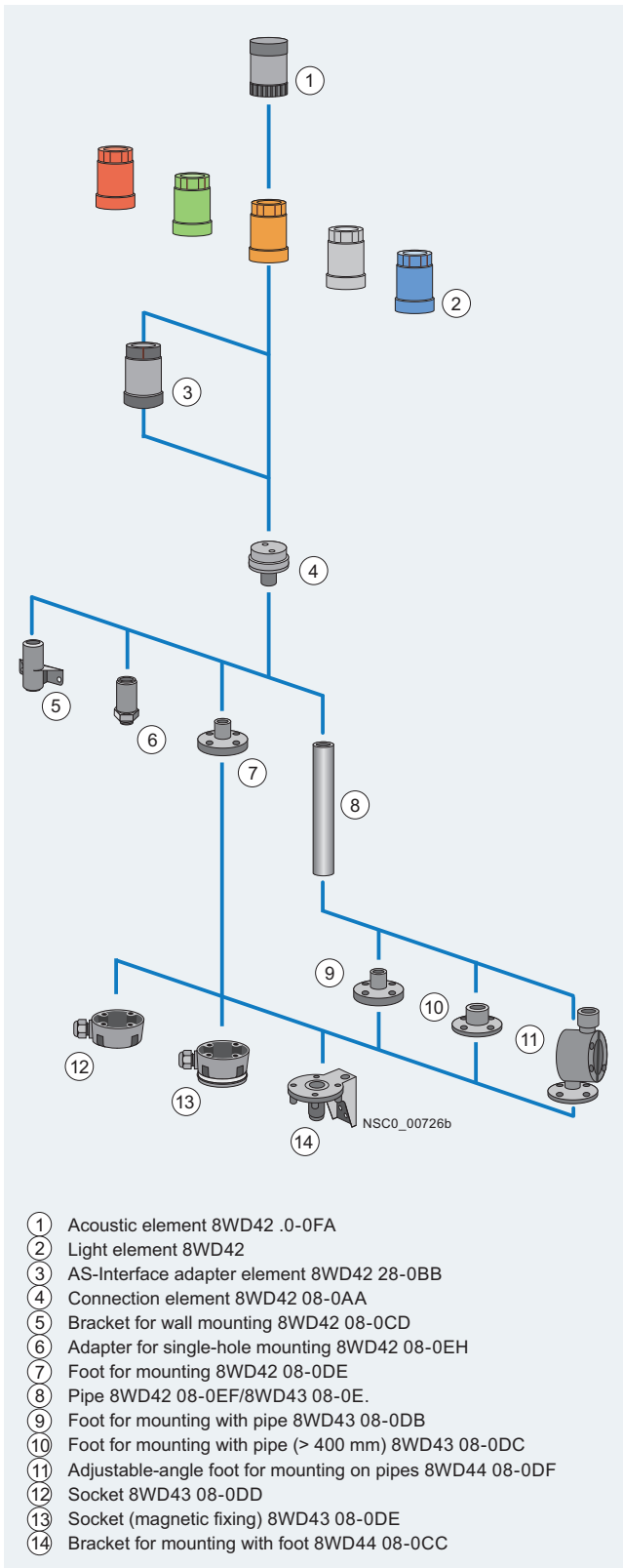

8WD42 signaling columns (width 50 mm) with up to 4 elements

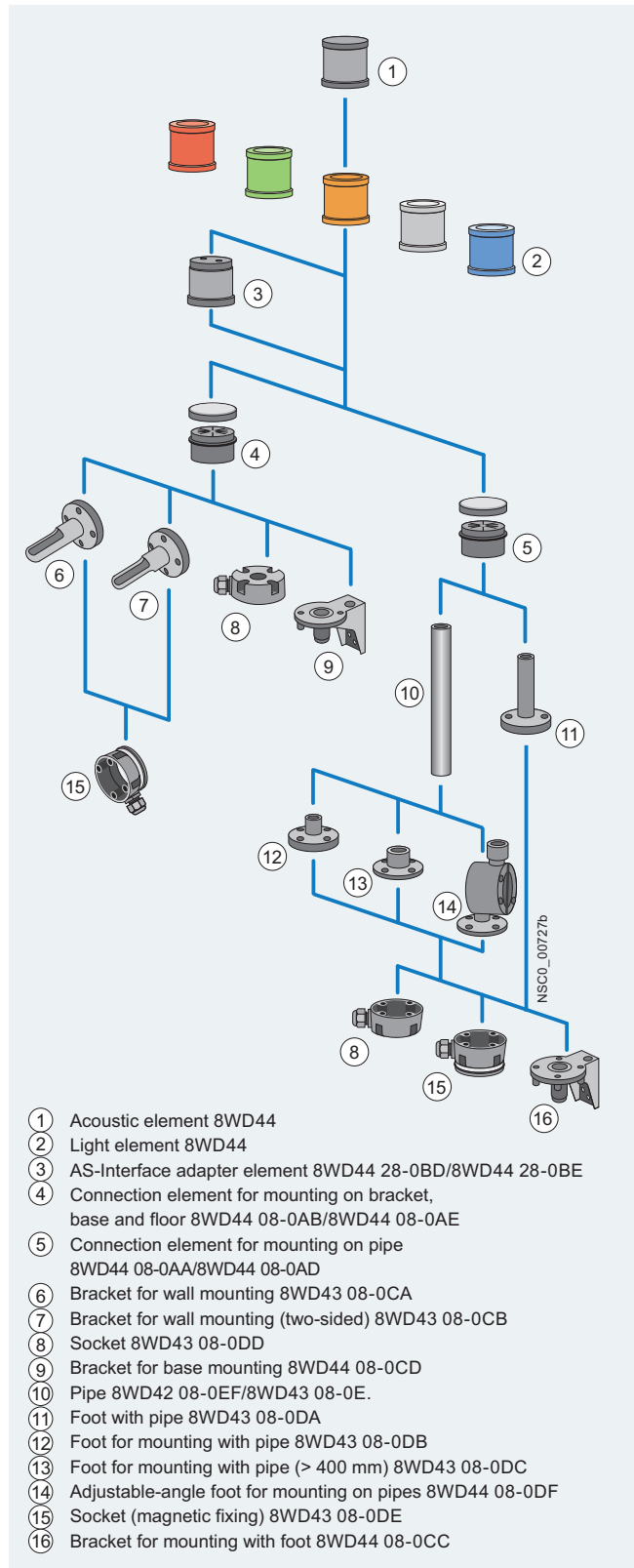

8WD44 signaling columns (width 70 mm) with up to 5 elements

# 8WD4 Signaling columns

## General data

Two product series are available:

- 8WD42
  - Thermoplast enclosure, diameter 50 mm
  - Degree of protection IP54
  - Up to 4 elements can be mounted between the connection element and the cover
- 8WD44
  - Thermoplast enclosure, diameter 70 mm
  - Advanced design and significantly improved illumination
  - Fast and flexible connection using spring-type terminals
  - Integrated degree of protection IP65
  - Up to 5 elements can be mounted between the connection element and the cover



Signaling columns, mounting examples

The illustrated examples are from the left:

- 8WD42: Cover (no No.), 4 light elements ②, connection element ④, pipe ⑧, foot ⑨
- 8WD44: Cover (no No.), acoustic element ①, 2 light elements ②, connection element ⑤, foot with pipe ⑪
- 8WD44: Cover (no No.), 4 light elements ②, AS-Interface adapter element ③, connection element ④, bracket for wall mounting ⑥
- 8WD44: Cover (no No.), 3 light elements ②, AS-Interface adapter element ③, connection element ⑤, foot with pipe ⑪

### Note:

*The cover is supplied with the connection element.*

## Benefits

- Choice of various light and acoustic elements with different functions: continuous light, blinklight, flashlight and rotating light; buzzer and siren
- Light elements with particularly long-lasting LEDs
- Variety of colors: red, yellow, green, white or blue
- Optimized illumination through improved prism technology with the 8WD44
- Acoustic elements can be adjusted in tone and volume
- Extremely resistant to shock and vibrations
- Easy connection and quick lamp change with secure bayonet mechanism
- Communication capability through connection to AS-Interface

## Application

8WD4 signaling columns are used in machines or in automatic processes for monitoring complex procedures or as visual or acoustic warning devices in emergency situations, e.g. for displaying individual assembly stages.

### Communication capability

#### Connection to AS-Interface

The 8WD4 signaling columns can be directly connected to the AS-Interface bus system through an adapter element that can be integrated. Wiring outlay is reduced as the result. The two-wire bus cable is fixed to the screw terminals in the connection element. Up to three signaling elements can be mounted on it using an adapter element.

A/B technology enables the connection of up to 62 slaves on one AS-Interface system.

### Connection

The signaling elements are wired up using the screw terminals in the connection element, screw terminals on the 8WD42 and screw or spring-type terminals on the 8WD44.

#### Cable outlet

The connecting cables can be guided either downwards or sideways through the cable gland using an adapter that can be screwed under the foot. This makes wiring easier if there is no access from below.

#### Connection to AS-Interface



#### 8WD42:

The two-wire bus cable is fixed to the screw terminals in the connection element. The adapter element must be the first module to be positioned on the connection element. A maximum of 4 signaling elements can then be mounted on it.

The 8WD42 28-0BB adapter element is a standard slave.

#### 8WD44:

The two-wire bus cable is fixed to the screw or spring-type terminals in the connection element. The adapter element must be the first module to be positioned on the connection element. The signaling elements can then be mounted on it.

The 8WD44 28-0BE adapter element is a standard slave. A maximum of 4 signaling elements can be mounted on it.









The 8WD44 28-0BD adapter element with A/B technology enables the connection of up to 62 slaves on one AS-Interface system. The addressing socket provides user-friendly parameterization of the AS-Interface elements. A maximum of 3 signaling elements can be mounted on it.

## Overview

Features:

- Thermoplast enclosure, diameter 50 mm
- Degree of protection IP54
- Up to 4 elements can be mounted

## Selection and ordering data

Version	Rated voltage V	Color	DT	Order No.	
<b>Acoustic elements<sup>1)</sup></b>					
	<b>Buzzer elements</b> 80 dB, pulsating or continuous tone, adjustable by means of a wire jumper	24 AC/DC	Black	A	<b>8WD42 20-0FA</b>
		115 AC		A	<b>8WD42 40-0FA</b>
		230 AC		A	<b>8WD42 50-0FA</b>
<b>Light elements for incandescent lamps/LEDs, BA 15d bases<sup>2)</sup></b>					
	<b>Continuous light elements</b>	24 ... 230 AC/DC	Red	A	<b>8WD42 00-1AB</b>
			Green	A	<b>8WD42 00-1AC</b>
			Yellow	A	<b>8WD42 00-1AD</b>
			Clear	A	<b>8WD42 00-1AE</b>
			Blue	A	<b>8WD42 00-1AF</b>
<b>Light elements with integrated LED</b>					
	<b>Continuous light elements</b>	24 AC/DC	Red	A	<b>8WD42 20-5AB</b>
			Green	A	<b>8WD42 20-5AC</b>
			Yellow	A	<b>8WD42 20-5AD</b>
  	<b>Blinklight elements</b>	24 AC/DC	Red	A	<b>8WD42 20-5BB</b>
			Green	A	<b>8WD42 20-5BC</b>
			Yellow	A	<b>8WD42 20-5BD</b>
			Clear	A	<b>8WD42 20-5BE</b>
			Blue	A	<b>8WD42 20-5BF</b>
		115 AC	Red	A	<b>8WD42 40-5BB</b>
			Green	A	<b>8WD42 40-5BC</b>
			Yellow	A	<b>8WD42 40-5BD</b>
			Clear	D	<b>8WD42 40-5BE</b>
			Blue	D	<b>8WD42 40-5BF</b>
230 AC	Red	A	<b>8WD42 50-5BB</b>		
	Green	A	<b>8WD42 50-5BC</b>		
	Yellow	A	<b>8WD42 50-5BD</b>		
	Clear	A	<b>8WD42 50-5BE</b>		
	Blue	A	<b>8WD42 50-5BF</b>		
<b>Adapter elements for AS-Interface</b>					
	<b>AS-Interface adapter elements</b> with external auxiliary voltage	For 4 signaling elements 24 V DC	Black	A	<b>8WD42 28-0BB</b>
					
<b>Connection elements<sup>3)</sup></b>					
	<b>Connection elements with cover</b> For mounting on pipes, floors and angles		Black	A	<b>8WD42 08-0AA</b>



<sup>1)</sup> The cover is included in the scope of supply of the acoustic elements and fixed in place.

<sup>2)</sup> The lamp is not included in the scope of supply. Please order separately.

<sup>3)</sup> The connection element with cover is an essential part for assembling the signaling columns.

# 8WD4 Signaling columns

## 8WD42 signaling columns, 50 mm diameter

Version	Rated voltage V	Color	DT	Order No.	
<b>Lamps</b>					
	<b>Incandescent lamps, 5 W</b>				
	Base BA 15d	24 AC/DC	A	<b>8WD43 28-1XX</b>	
		115 AC	A	<b>8WD43 48-1XX</b>	
		230 AC	A	<b>8WD43 58-1XX</b>	
	<b>LEDs</b>				
	Base BA 15d	24 AC/DC	Red	A	<b>8WD44 28-6XB</b>
			Green	A	<b>8WD44 28-6XC</b>
			Yellow	A	<b>8WD44 28-6XD</b>
			Clear	A	<b>8WD44 28-6XE</b>
			Blue	A	<b>8WD44 28-6XF</b>
	115 AC		Red	A	<b>8WD44 48-6XB</b>
			Green	A	<b>8WD44 48-6XC</b>
			Yellow	A	<b>8WD44 48-6XD</b>
			Clear	A	<b>8WD44 48-6XE</b>
			Blue	A	<b>8WD44 48-6XF</b>
	230 AC		Red	A	<b>8WD44 58-6XB</b>
			Green	A	<b>8WD44 58-6XC</b>
			Yellow	A	<b>8WD44 58-6XD</b>
			Clear	A	<b>8WD44 58-6XE</b>
Blue			A	<b>8WD44 58-6XF</b>	
<b>Mounting</b>					
	<b>Feet, single</b>				
		Plastic, for mounting on pipes	A	<b>8WD43 08-0DB</b>	
		Metal, for pipe lengths > 400 mm	A	<b>8WD43 08-0DC</b>	
	Plastic, for floor mounting (without pipe)	A	<b>8WD42 08-0DE</b>		
	<b>Adjustable-angle feet</b> For positioning in 7.5° increments <sup>1)</sup>		Plastic, for mounting on pipes, incl. rubber seal	X	<b>8WD44 08-0DF</b>
	<b>Pipes, single</b>				
	Length 100 mm		A	<b>8WD42 08-0EF</b>	
	Length 150 mm		A	<b>8WD43 08-0EE</b>	
	Length 250 mm		A	<b>8WD43 08-0EA</b>	
	Length 400 mm		A	<b>8WD43 08-0EB</b>	
	Length 1000 mm		A	<b>8WD43 08-0ED</b>	
	<b>Sockets for feet</b>				
		Side cable outlet	A	<b>8WD43 08-0DD</b>	
		Side cable outlet, with magnetic fixing <sup>2)</sup>	A	<b>8WD43 08-0DE</b>	
	<b>Brackets for mounting with foot</b>			A	<b>8WD44 08-0CC</b>
	<b>Brackets for wall mounting</b> (plastic)		Mounting without feet and pipe	A	<b>8WD42 08-0CD</b>
	<b>Adapters for single-hole mounting</b>		Mounting without feet and pipe, with M18 thread and fixing nut	A	<b>8WD42 08-0EH</b>

For labeling panels, see 8WD44, page 2/133.

<sup>1)</sup> Markings for 30°, 45°, 60° and 90°.

<sup>2)</sup> For horizontal mounting, only 1 element is recommended.











## Overview

### Features:

- Thermoplast enclosure, diameter 70 mm
- Advanced design and significantly improved illumination

- Fast and flexible connection using spring-type terminals
- Integrated degree of protection IP65
- Up to 5 elements can be mounted.

## Selection and ordering data

Version	Rated voltage V	Color	DT	Order No.			
<b>Acoustic elements<sup>1)</sup></b>							
	<b>Buzzer elements</b> 85 dB, pulsating or continuous tone, adjustable by means of a wire jumper	24 AC/DC	Black	A	<b>8WD44 20-0FA</b>		
		115 AC		A	<b>8WD44 40-0FA</b>		
		230 AC		A	<b>8WD44 50-0FA</b>		
	<b>Siren elements</b> , multi-tone, 100 dB, 8 tones and volume are adjustable	24 AC/DC	Black	A	<b>8WD44 20-0EA2</b>		
		115 AC		A	<b>8WD44 40-0EA2</b>		
		230 AC		A	<b>8WD44 50-0EA2</b>		
<b>Siren elements</b> 108 dB, IP40	24 DC	Black	A	<b>8WD44 20-0EA</b>			
<b>Light elements for incandescent lamps/LEDs, BA 15d bases<sup>2)</sup></b>							
	<b>Continuous light elements</b>	12 ... 230 AC/DC	Red	A	<b>8WD44 00-1AB</b>		
			Green	A	<b>8WD44 00-1AC</b>		
			Yellow	A	<b>8WD44 00-1AD</b>		
			Clear	A	<b>8WD44 00-1AE</b>		
			Blue	A	<b>8WD44 00-1AF</b>		
			  	<b>Blinklight elements</b>	24 AC/DC	Red	A
Green	A	<b>8WD44 20-1BC</b>					
Yellow	A	<b>8WD44 20-1BD</b>					
Clear	A	<b>8WD44 20-1BE</b>					
Blue	A	<b>8WD44 20-1BF</b>					
115 AC	Red	A				<b>8WD44 40-1BB</b>	
	Green	A				<b>8WD44 40-1BC</b>	
	Yellow	A				<b>8WD44 40-1BD</b>	
	Clear	A				<b>8WD44 40-1BE</b>	
	Blue	A			<b>8WD44 40-1BF</b>		
	230 AC	Red			A	<b>8WD44 50-1BB</b>	
Green		A			<b>8WD44 50-1BC</b>		
Yellow		A			<b>8WD44 50-1BD</b>		
Clear		A			<b>8WD44 50-1BE</b>		
Blue		A			<b>8WD44 50-1BF</b>		
<b>Light elements with integrated flash lamps<sup>3)</sup></b>							
  	<b>Flashlight elements</b> with integrated electronic flash	24 DC			Red	A	<b>8WD44 20-0CB</b>
					Green	A	<b>8WD44 20-0CC</b>
			Yellow	A	<b>8WD44 20-0CD</b>		
			Clear	A	<b>8WD44 20-0CE</b>		
			Blue	A	<b>8WD44 20-0CF</b>		
		115 AC	Red	A	<b>8WD44 40-0CB</b>		
			Green	D	<b>8WD44 40-0CC</b>		
			Yellow	A	<b>8WD44 40-0CD</b>		
			Clear	D	<b>8WD44 40-0CE</b>		
			Blue	D	<b>8WD44 40-0CF</b>		
		230 AC	Red	A	<b>8WD44 50-0CB</b>		
			Green	A	<b>8WD44 50-0CC</b>		
			Yellow	A	<b>8WD44 50-0CD</b>		
			Clear	A	<b>8WD44 50-0CE</b>		
			Blue	A	<b>8WD44 50-0CF</b>		









<sup>1)</sup> The cover is included in the scope of supply of the acoustic elements and fixed in place.

<sup>2)</sup> The lamp is not included in the scope of supply. Please order separately.

<sup>3)</sup> The lamp is included in the scope of supply.

# 8WD4 Signaling columns

## 8WD44 signaling columns, 70 mm diameter

Version	Rated voltage V	Color	DT	Order No.			
<b>Light elements with integrated LED</b>							
   	<b>Continuous light elements</b>	24 AC/DC	Red Green Yellow Clear Blue	A A A A A	<b>8WD44 20-5AB</b> <b>8WD44 20-5AC</b> <b>8WD44 20-5AD</b> <b>8WD44 20-5AE</b> <b>8WD44 20-5AF</b>		
		115 AC	Red Green Yellow Clear Blue	A A A A A	<b>8WD44 40-5AB</b> <b>8WD44 40-5AC</b> <b>8WD44 40-5AD</b> <b>8WD44 40-5AE</b> <b>8WD44 40-5AF</b>		
		230 AC	Red Green Yellow Clear Blue	A A A A A	<b>8WD44 50-5AB</b> <b>8WD44 50-5AC</b> <b>8WD44 50-5AD</b> <b>8WD44 50-5AE</b> <b>8WD44 50-5AF</b>		
		<b>Blinklight elements</b>	24 AC/DC	Red Green Yellow	A A A	<b>8WD44 20-5BB</b> <b>8WD44 20-5BC</b> <b>8WD44 20-5BD</b>	
		<b>Rotating light elements</b>	24 AC/DC	Red Green Yellow	A A A	<b>8WD44 20-5DB</b> <b>8WD44 20-5DC</b> <b>8WD44 20-5DD</b>	
	<b>Adapter elements for AS-Interface</b>						
		<b>AS-Interface adapter elements</b>					
		<ul style="list-style-type: none"> <li>A/B technology, with/without external auxiliary voltage, switchable</li> <li>Standard AS-Interface, with external auxiliary voltage</li> </ul>		For 3 signaling elements 24 V DC	Black	A	<b>8WD44 28-0BD</b>
				For 4 signaling elements 24 V DC	Black	A	<b>8WD44 28-0BE</b>
	<b>Connection elements<sup>1)</sup></b>						
		<b>Connection elements with cover</b>		Black			
		Screw terminals					
<ul style="list-style-type: none"> <li>For mounting on pipes</li> <li>For mounting on bracket and floor</li> </ul>				A	<b>8WD44 08-0AA</b> <b>8WD44 08-0AB</b>		
Spring-type terminals							
	<ul style="list-style-type: none"> <li>For mounting on pipes</li> <li>For mounting on bracket and floor</li> </ul>			A	<b>8WD44 08-0AD</b> <b>8WD44 08-0AE</b>		
<b>Bulbs</b>							
	<b>Incandescent bulbs, 5 W</b>						
	Base BA 15d	24 AC/DC		A	<b>8WD43 28-1XX</b>		
		115 AC		A	<b>8WD43 48-1XX</b>		
		230 AC		A	<b>8WD43 58-1XX</b>		
	<b>LEDs</b>						
	Base BA 15d	24 AC/DC	Red Green Yellow Clear Blue	A A A A A	<b>8WD44 28-6XB</b> <b>8WD44 28-6XC</b> <b>8WD44 28-6XD</b> <b>8WD44 28-6XE</b> <b>8WD44 28-6XF</b>		
		115 AC	Red Green Yellow Clear Blue	A A A A A	<b>8WD44 48-6XB</b> <b>8WD44 48-6XC</b> <b>8WD44 48-6XD</b> <b>8WD44 48-6XE</b> <b>8WD44 48-6XF</b>		
		230 AC	Red Green Yellow Clear Blue	A A A A A	<b>8WD44 58-6XB</b> <b>8WD44 58-6XC</b> <b>8WD44 58-6XD</b> <b>8WD44 58-6XE</b> <b>8WD44 58-6XF</b>		

<sup>1)</sup> The connection element with cover is an essential part for assembling the signaling columns.

## 8WD44 signaling columns, 70 mm diameter

Version	DT	Order No.		
<b>Mounting</b>				
	<b>Feet with pipe</b>	Pipe length 100 mm	A	<b>8WD43 08-0DA</b>
	<b>Feet, single</b>	Plastic, for mounting on pipes	A	<b>8WD43 08-0DB</b>
		Metal, for pipe lengths > 400 mm	A	<b>8WD43 08-0DC</b>
	<b>Adjustable-angle feet</b> For positioning in 7.5° increments <sup>1)</sup>	Plastic, for mounting on pipes, incl. rubber seal	X	<b>8WD44 08-0DF</b>
	<b>Pipes, single</b>	Length 100 mm	A	<b>8WD42 08-0EF</b>
		Length 150 mm	A	<b>8WD43 08-0EE</b>
		Length 250 mm	A	<b>8WD43 08-0EA</b>
		Length 400 mm	A	<b>8WD43 08-0EB</b>
		Length 1000 mm	A	<b>8WD43 08-0ED</b>
	<b>Sockets for feet</b>	Side cable outlet (can also be used without feet)	A	<b>8WD43 08-0DD</b>
		Side cable outlet, with magnetic fixing <sup>2)</sup>	A	<b>8WD43 08-0DE</b>
	<b>Brackets for wall mounting</b> (mounting without feet and pipe)	For single-sided mounting	A	<b>8WD43 08-0CA</b>
		For double-sided mounting	A	<b>8WD43 08-0CB</b>
	<b>Brackets for mounting with foot</b>		A	<b>8WD44 08-0CC</b>
	<b>Brackets for base mounting</b>	Mounting without feet and pipe	A	<b>8WD44 08-0CD</b>
	<b>Adapters for mounting on pipes according to NPT</b>	Mounting on pipes, Ø 25 mm, with NPT 1/2" thread	A	<b>8WD43 08-0DF</b>
<b>Inscriptions</b>				
	<b>Labeling panels</b>	With fixing accessories for mounting on pipe Ø 25 mm Inscription area / step 50 mm x 140 mm Suitable for standard labels, e.g. • Zweckform 3425 • Herma 4457	A	<b>8WD44 08-0FA</b>

<sup>1)</sup> Markings for 30°, 45°, 60° and 90°.

<sup>2)</sup> For horizontal mounting, only 1 element is recommended.

# 8WD5 Integrated signal lamps

## 8WD53 integrated signal lamps, 70 mm diameter

### Overview



Integrated signal lamps

### Design

#### Features:

- Thermoplast enclosures, diameter 70 mm
- Degree of protection IP65
- Rated voltage 24 V, 115 V, 230 V AC/DC
- Ambient temperature -20 to +50 °C, incandescent lamp up to 60 °C

The special shape of the integrated signal lamps means that the light is emitted optimally in every direction (to the sides and upwards). Continuous lights (with incandescent lamp or LED) and single-flash lights are available in five colors.





The LED versions of the integrated signal lamps offer a considerably longer endurance than the incandescent lamp versions.

All integrated signal lamps have a high degree of protection IP65 and are made of a material highly resistant to impact.

### Mounting

8WD53 integrated signal lamps can be mounted directly at any point of the machine for the purpose of giving visual signals. They are mounted by means of a Pg 29 screw base with nut.

### Selection and ordering data

Version	Rated voltage	Color	DT	Order No.		
<b>Lights for incandescent lamps/LED, BA 15d base</b>						
	<b>Continuous lights<sup>1)</sup></b>	24 ... 230 AC/DC	Red	A	<b>8WD53 00-1AB</b>	
			Green	A	<b>8WD53 00-1AC</b>	
			Yellow	A	<b>8WD53 00-1AD</b>	
			Clear	A	<b>8WD53 00-1AE</b>	
			Blue	A	<b>8WD53 00-1AF</b>	
<b>Lights with integrated flash lamp</b>						
  	<b>Single-flash lights with integrated electronic flash</b>	24 AC/DC	Red	A	<b>8WD53 20-0CB</b>	
			Green	D	<b>8WD53 20-0CC</b>	
			Yellow	A	<b>8WD53 20-0CD</b>	
			Clear	A	<b>8WD53 20-0CE</b>	
			Blue	A	<b>8WD53 20-0CF</b>	
	115 AC			Red	A	<b>8WD53 40-0CB</b>
				Green	D	<b>8WD53 40-0CC</b>
				Yellow	D	<b>8WD53 40-0CD</b>
				Clear	D	<b>8WD53 40-0CE</b>
				Blue	D	<b>8WD53 40-0CF</b>
230 AC			Red	A	<b>8WD53 50-0CB</b>	
			Green	D	<b>8WD53 50-0CC</b>	
			Yellow	A	<b>8WD53 50-0CD</b>	
			Clear	A	<b>8WD53 50-0CE</b>	
			Blue	D	<b>8WD53 50-0CF</b>	
<b>Lights with integrated LED</b>						
	<b>Continuous lights</b>	24 AC/DC	Red	A	<b>8WD53 20-5AB</b>	
			Green	A	<b>8WD53 20-5AC</b>	
			Yellow	A	<b>8WD53 20-5AD</b>	
	<b>Blinklight lamps</b>	24 AC/DC	Red	A	<b>8WD53 20-5BB</b>	
			Green	D	<b>8WD53 20-5BC</b>	
			Yellow	A	<b>8WD53 20-5BD</b>	
	<b>Rotating lights</b>	24 AC/DC	Red	A	<b>8WD53 20-5DB</b>	
			Green	A	<b>8WD53 20-5DC</b>	
			Yellow	A	<b>8WD53 20-5DD</b>	

For incandescent lamps and LEDs see Signaling Columns.

<sup>1)</sup> Bulb not included in scope of supply. Please order separately.

## Overview



## Function

- Input / output fields for displaying and changing of process values.
- Function keys are used for directly triggering functions and actions. Up to 16 functions can be configured simultaneously on function keys. The function keys can also be used directly as PROFINET IO. The function keys can also be reconfigured as system keys. A frequently used function such as "Acknowledge alarm" can thus be assigned to a function key.
- Auxiliary operator controls such as handwheels, key switches and illuminated pushbuttons can be assigned with a variable or as a direct actuation via PROFINET IO (direct keys).
- Buttons are used for direct triggering of functions and actions. Up to 16 functions can be configured simultaneously on buttons.
- Graphics can be used as symbols instead of text for "labeling" function keys or buttons. They can also be used as full-screen background images. In the configuration software, a comprehensive library is available containing graphics and a wide variety of objects. All editors with an OLE interface can be used as graphics editors (such as PaintShop, Designer or CorelDraw).
- Vector graphics; simple geometric basic forms (e.g. lines, circles and rectangles) can be created directly in the configuration software.
- Text fields for labeling function keys, process displays, and process values in any font size.
- Trend views and bars are used for the graphic display of dynamic values.
- Display selection from the controller permits operator prompting from the controller.
- Presentation of HTML documents with MS Pocket Internet Explorer.
- Visual Basic Script, flexibility thanks to the implementation of new functions including linking to variables (comparison operations, loops, etc.).
- Language switching  
16 online languages, 32 configuration languages incl. Asiatic and Cyrillic character sets
  - Language-dependent texts and graphics
- User administration (security)
  - User-oriented access protection according to requirements of specific sectors
  - Authentication with user name and password
  - User-group-specific rights

## SIMATIC Mobile Panel 277(F) IWLAN

## Function (continued)

- Signalling system
  - Discrete and analog alarms (edge alarms) as well as the ALARM\_S message frame procedure for SIMATIC S7
  - Freely definable message classes (e.g. status / fault messages) for definition of acknowledgment response and display of alarm events
- Message buffer
  - Non-volatile, maintenance-free and battery-free message buffer. The messages remain stored when the mobile panel has the battery removed as well
- Recipe management
  - With additional data storage (on optional multi-media card / SD card)
  - Online / offline processing on the panel
  - Storage of recipe data in standard Windows format (CSV)
  - External processing using standard tools such as Excel and Access is possible
- Help texts for process images, messages and variables.
- Arithmetic functions
- Limit value monitoring for reliable process control of inputs and outputs.
- Indicator light for machine and plant status indication.
- Scheduler for cyclic function processing.
- Dynamic positioning of objects and dynamic showing / hiding of objects
- Permanent window and template concept
  - Creation of screen templates
- Simple maintenance and configuration thanks to:
  - Backup / restore of the project, operating system, recipe data records and firmware on the optional standard multi-media card / SD card
  - Backup and restoration of configuration, operating system, recipe data sets and firmware on a PC using ProSave
  - Project transfer / return transfer via PROFINET / WLAN
  - Automatic transfer identification
  - Individual brightness setting
  - Project simulation directly on the configuration computer
- WinCC flexible options
  - Sm@rtService for remote operator control and monitoring of SIMATIC HMI systems based on TCP/IP networks
  - Sm@rtAccess for communication between HMI systems based on TCP/IP networks. Remote access to recipe data records, passwords and HMI system-specific information, and much more.  
(Mobile Panel 277F IWLAN as server: View only)
  - OPC server: Communication with applications (e.g. MES, ERP, or applications in the office sector) from various manufacturers (see HMI software / runtime software SIMATIC WinCC flexible / WinCC flexible RT options)
  - Audit

## Configuring

Configuration is carried out with the SIMATIC WinCC flexible Standard or Advanced configuration software (see Catalog ST80 / ST PC, SIMATIC WinCC flexible HMI software / engineering software).

SIMATIC WinCC flexible is the logical further development of the field-proven ProTool family. Projects generated using ProTool can be easily migrated to WinCC.

If WinCC flexible is started directly from SIMATIC Manager, data in STEP 7 can be accessed directly when the panel is configured. Duplicated data input and data management is, therefore, avoided.



## IWLAN infrastructure

The required IWLAN infrastructure is set up with the IWLAN Access Points SCALANCE W-780, preferably with the version SCALANCE W786-2RR, which fully supports all possible applications of the Mobile Panel 277(F) IWLAN.

For operating a plant without fail-safe communication, the version SCALANCE W786-1PRO can also be used.

The Access Point provides an Industrial Ethernet interface for connection to the wired network.

In addition to a reliable radio link, the SCALANCE W-780 Access Points stand out due to their optimum support of standardized IT mechanisms:

- IEEE 802.11b / g / a / h for different frequency ranges
- IEEE 802.11e for multimedia, wireless multimedia (WMM) <sup>1)</sup>
- IEEE 802.11i for security <sup>1)</sup>
- Construction of redundant networks with the Rapid Spanning Tree Protocol (RSTP)
- Virtual networks (VLAN) to logically separate, for example, different user groups
- Sending the log entries of the SCALANCE W devices to a Syslog server

<sup>1)</sup> Not supported by Mobile Panel Wireless

## SIMATIC Mobile Panel 277(F) IWLAN

## Integration

The SIMATIC Mobile Panel 277(F) IWLAN communicates via the WLAN Standard IEEE 802.11 a(b / g) via PROFINET. The Mobile Panel 277F IWLAN devices also support PROFIsafe communication.

There are four device versions for V1 and five device versions for V2:

For mobile operation and monitoring via WLAN:

- "Mobile Panel 277 IWLAN
- "Mobile Panel 277 IWLAN with handwheel, key switch and illuminated pushbuttons

As fail-safe device for safety-oriented operation as well:

- Mobile Panel 277F IWLAN with enable button and emergency stop button
- Mobile Panel 277F IWLAN with enable button, emergency stop button, handwheel, key switch and illuminated pushbuttons
- Mobile Panel 277F IWLAN RFID Tag (for V2 only)

For the versions Mobile Panel 277F IWLAN (PROFIsafe), the following system prerequisites apply:

- The Mobile Panel must be connected as a safe device (PROFIsafe, Distributed Safety)
- Use of a SIMATIC F-CPU

SIMATIC Mobile Panel	5 GHz frequency band (IEEE 802.11a)	SIMATIC F-CPU (Distributed Safety)
<b>277 IWLAN</b>	Only WLAN utilization (HMI)	x
	When using transponders	!
	When using PROFINET IO	x
<b>277F IWLAN</b>	Failsafe	!
<b>277F IWLAN (RFID transponder)</b>	Failsafe	x

X recommended

! requirement

– not required

The Mobile Panel 277(F) IWLAN can be connected to:

- SIMATIC S7-200 / -300 / -400 (one F-CPU required for integrating the Mobile Panel 277F IWLAN)

Note:

Further information can be found in Catalog ST80 / STPC, under "System interfaces".

The Function Manuals "Fail-Safe Operation of the Mobile Panel 277F IWLAN" are available for downloading in English, German, and Japanese.

<http://support.automation.siemens.com/WW/view/en/31255853>

## Technical specifications

Version	6AV6 645-0DD01-0AX1 (RoW version)	6AV6 645-0DE01-0AX1 (RoW version)	6AV6 645-0EB01-0AX1 (RoW version)	6AV6 645-0EC01-0AX1 (RoW version)	6AV6 645-0EF01-0AX1 (RoW version)
<b>SIMATIC Mobile Panel</b>	<b>277 IWLAN V2: Communication via WLAN (PROFINET)</b>	<b>277 IWLAN V2: Communication via WLAN (PROFINET) with integrated handwheel, key-operated switch and two illuminated pushbuttons</b>	<b>277(F) IWLAN V2: Communication via WLAN (PROFINET) with acknowledgement button and emergency stop button</b>	<b>277(F) IWLAN V2: Communication via WLAN (PROFINET) with acknowledgement button and emergency stop button with integrated handwheel, key-operated switch, and two illuminated pushbuttons</b>	<b>RFID tag version: Communication via WLAN (PROFINET) with acknowledgement button and emergency stop button with integrated handwheel, key-operated switch, and two illuminated pushbuttons</b>
<b>Mechanics</b>					
Type of housing (front)	Plastic	Plastic	Plastic	Plastic	Plastic
<b>Degree of protection</b>					
Housing	IP65	IP65	IP65	IP65	IP65
<b>Memory</b>					
Type	Flash / RAM	Flash / RAM	Flash / RAM	Flash / RAM	Flash / RAM
Usable memory for user data	6 MB	6 MB	6 MB	6 MB	6 MB
<b>Display</b>					
Type	TFT, 65536 colors	TFT, 65536 colors	TFT, 65536 colors	TFT, 65536 colors	TFT, 65536 colors
Resolution (pixels)	640 x 480	640 x 480	640 x 480	640 x 480	640 x 480
<b>Dimensions</b>					
Housing diameter / depth (mm)	Dia 290 mm / D 103 mm	Dia 290 mm / D 103 mm	Dia 290 mm / D 103 mm	Dia 290 mm / D 103 mm	Dia 290 mm / D 103 mm
<b>Weight</b>					
Weight	2.2 kg	2.2 kg	2.2 kg	2.2 kg	2.2 kg

## SIMATIC Mobile Panel 277(F) IWLAN

Ordering data	Order No.	Order No.
<b>SIMATIC Mobile Panel 277 IWLAN V2 (RoW version)</b> <ul style="list-style-type: none"> <li>• Communication via WLAN (PROFINET)</li> <li>• Communication via WLAN (PROFINET) with integrated handwheel, key-operated switch and two illuminated pushbuttons</li> </ul>	H <b>6AV6 645-0DD01-0AX1</b>	<ul style="list-style-type: none"> <li>• Charger for safe storage and charging the device incl. lock for securing the device in the charger. Charging capabilities for up to two additional batteries</li> </ul>
	H <b>6AV6 645-0DE01-0AX1</b>	<ul style="list-style-type: none"> <li>• Additional battery with LED indicator for indicating the charge status</li> </ul>
		<ul style="list-style-type: none"> <li>• Transponder V2 incl. batteries (3 x AA)</li> </ul>
		<ul style="list-style-type: none"> <li>• Transponder V1 incl. batteries (3 x AA)</li> </ul>
<b>SIMATIC Mobile Panel 277F IWLAN V2 PROFIsafe (RoW version)</b> <ul style="list-style-type: none"> <li>• Communication via WLAN (PROFINET) with acknowledgement button and emergency stop button</li> <li>• Communication via WLAN (PROFINET) with acknowledgement button and emergency stop button with integrated handwheel, key-operated switch, and two illuminated pushbuttons</li> <li>• RFID tag version: Communication via WLAN (PROFINET) with acknowledgement button and emergency stop button with integrated handwheel, key-operated switch, and two illuminated pushbuttons</li> </ul>	H <b>6AV6 645-0EB01-0AX1</b>	<b>Service pack for Mobile Panel 277(F) IWLAN</b> <p>contains accessories pack (labeling strip cover), battery compartment cover (device), backup battery, cover left / right (charger), power supply connector counterpart (charger), replacement key (charger)</p>
	H <b>6AV6 645-0EC01-0AX1</b>	
	<b>6AV6 645-0EF01-0AX1</b>	
		<ul style="list-style-type: none"> <li>• Service pack V2 for Mobile Panel 277(F) IWLAN V2</li> <li>• Service pack V1 for Mobile Panel 277(F) IWLAN V1</li> </ul>
<b>SIMATIC Mobile Panel 277 IWLAN V2 (USA version)</b> <ul style="list-style-type: none"> <li>• Communication via WLAN (PROFINET)</li> <li>• Communication via WLAN (PROFINET) with integrated handwheel, key-operated switch and two illuminated pushbuttons</li> </ul>	H <b>6AV6 645-0FD01-0AX1</b>	<b>SCALANCE W-786 Access Points for SIMATIC Mobile Panel 277(F) IWLAN</b> <p>IWLAN Access Points with integrated radio interfaces; radio networks; IEEE 802.11b / g / a / h at 2.4 / 5 GHz up to 54 Mbit/s. National approvals; WPA2/AES; Power over Ethernet (PoE), degree of protection IP65 (-40 °C to +70 °C); scope of delivery: Mounting hardware, 48 V DC terminal block; manual on CD-ROM; Ger / English</p>
	H <b>6AV6 645-0FE01-0AX1</b>	<b>SCALANCE W-786-2RR</b> <p>IWLAN Dual Access Point with two integrated radio interface for setting up radio links with iPCF; RJ45 connection</p> <p>Four internal antennas</p> <ul style="list-style-type: none"> <li>• National approvals for operation outside the U.S.</li> <li>• National approvals for operation within the U.S.</li> </ul>
<b>SIMATIC Mobile Panel 277F IWLAN V2 PROFIsafe (USA version)</b> <ul style="list-style-type: none"> <li>• Communication via WLAN (PROFINET) with acknowledgement button and emergency stop button</li> <li>• Communication via WLAN (PROFINET) with acknowledgement button and emergency stop button with integrated handwheel, key-operated switch, and two illuminated pushbuttons</li> </ul>	H <b>6AV6 645-0GB01-0AX1</b>	
	H <b>6AV6 645-0GC01-0AX1</b>	
<b>Starter kit SIMATIC Mobile Panel 277(F) IWLAN (RoW version)</b> <ul style="list-style-type: none"> <li>• Mobile Panel 277 IWLAN V2</li> <li>• Mobile Panel 277F IWLAN V2</li> </ul>	<b>6AV6 651-5GA01-0AA1</b>	<b>SCALANCE W-786-1PRO</b> <p>IWLAN Access Points with built-in wireless interface RJ45 connection</p> <p>Two internal antennas</p> <ul style="list-style-type: none"> <li>• National approvals for operation outside the U.S.</li> <li>• National approvals for operation within the U.S.</li> </ul>
	<b>6AV6 651-5HA01-0AA1</b>	
<b>Accessories</b> <p>Note: Please order the table-top power supply or charging station as well. Required for charging the battery</p> <ul style="list-style-type: none"> <li>• Table-top power supply incl. power cable for EU, US, UK, JP (only suitable for operation under laboratory / office conditions)</li> </ul>	B <b>6AV6 671-5CN00-0AX2</b>	



## SIMATIC Mobile Panel 277(F) IWLAN

**Further IWLAN Access Point versions**

<b>SCALANCE W-784 Access Points</b> IWLAN Access Points with integrated radio interfaces (see Catalog IK PI), radio networks IEEE 802.11b / g / a / h at 2.4 / 5 GHz up to 54 Mbit/s. National approvals; WPA2/AES; Power over Ethernet (PoE), degree of protection IP30 (-20 °C to +60 °C); scope of delivery: Mounting hardware, 24 V DC terminal block; manual on CD-ROM; German / English	<b>6GK5 784-1AA30-...</b> (see Catalog IK PI)
<b>SCALANCE W-786 Access Points</b> IWLAN Access Points with integrated radio interfaces (see Catalog IK PI); radio networks IEEE 802.11b / g / a / h at 2.4 / 5 GHz up to 54 Mbit/s. National approvals; WPA2/AES; Power over Ethernet (PoE), degree of protection IP65 (-40°C to +70°C); scope of delivery: Mounting hardware, 48 V DC terminal block; manual on CD-ROM; German / English;	<b>6GK5 786-...</b> (see Catalog IK PI)
<b>SCALANCE W-788 Access Points</b> IWLAN Access Points with integrated radio interfaces (see Catalog IK PI); radio networks IEEE 802.11b / g / a / h at 2.4 / 5 GHz up to 54 Mbit/s. National approvals; WPA2/AES; Power over Ethernet (PoE), degree of protection IP65 (-20°C to +60°C); scope of delivery: 2 ANT795-4MR antennas, IP67 hybrid plug-in connector, mounting hardware, manual on CD-ROM, German / English	<b>6GK5 788-...</b> (see Catalog IK PI)
<b>PS791-2DC power supply</b> 24 V DC power supply for installation in SCALANCE W-786 products; operating instructions in German / English	<b>6GK5 791-2DC00-0AA0</b>
<b>PS791-2AC power supply</b> 110 V AC to 230 V AC power supply for installation in SCALANCE W-786 products; operating instructions in German / English	<b>6GK5 791-2AC00-0AA0</b>
<b>Other compatible accessories</b>	
<b>Wall mounting bracket for Mobile Panels</b>	<b>6AV4 574-1AF04-4AA0</b>
<b>Memory card multi-media card / SD card</b>	<b>6AV6 671-1CB00-0AX2</b>
<b>Spare key for Mobile Panels</b>	<b>6AV6 574-1AG04-4AA0</b>
<b>Configuring</b> with SIMATIC WinCC flexible	see Catalog ST 80 / ST PC, HMI Software (chapter 4)

**Documentation (to be ordered separately)****Mobile Panel 277F IWLAN Operating Instructions**

• German	<b>6AV6 691-1DQ01-2AA1</b>
• English	<b>6AV6 691-1DQ01-2AB1</b>
• French	<b>6AV6 691-1DQ01-2AC1</b>
• Italian	<b>6AV6 691-1DQ01-2AD1</b>
• Spanish	<b>6AV6 691-1DQ01-2AE1</b>

**Mobile Panel 277 IWLAN Operating Instructions**

• German	<b>6AV6 691-1DM01-2AA1</b>
• English	<b>6AV6 691-1DM01-2AB1</b>
• French	<b>6AV6 691-1DM01-2AC1</b>
• Italian	<b>6AV6 691-1DM01-2AD1</b>
• Spanish	<b>6AV6 691-1DM01-2AE1</b>

**Getting Started Mobile Panel 277(F) IWLAN**

• German	available as pdf
• English	available as pdf

**User Manual WinCC flexible Compact / Standard / Advanced**

• German	<b>6AV6 691-1AB01-3AA0</b>
• English	<b>6AV6 691-1AB01-3AB0</b>
• French	<b>6AV6 691-1AB01-3AC0</b>
• Italian	<b>6AV6 691-1AB01-3AD0</b>
• Spanish	<b>6AV6 691-1AB01-3AE0</b>

**WinCC flexible Communication User Manual**

• German	<b>6AV6 691-1CA01-3AA0</b>
• English	<b>6AV6 691-1CA01-3AB0</b>
• French	<b>6AV6 691-1CA01-3AC0</b>
• Italian	<b>6AV6 691-1CA01-3AD0</b>
• Spanish	<b>6AV6 691-1CA01-3AE0</b>

A: Subject to export regulations: AL: N and ECCN: EAR99S  
 B: Subject to export regulations: AL: N and ECCN: EAR99H  
 H: Subject to export regulations: AL: N and ECCN: 5D002ENC3  
 K: Subject to export regulations: AL: 5A002A1A2 and ECCN: 5A002ENC3

The Function Manuals "Fail-Safe Operation of the Mobile Panel 277F IWLAN" are available for downloading in English, German, and Japanese.

<http://support.automation.siemens.com/WW/view/en/31255853>

# Process analytical instruments

## Continuous gas analyzers, extractive

### ULTRAMAT, OXYMAT, CALOMAT

#### Overview ULTRAMAT 23C



The ULTRAMAT 23 gas analyzer can measure up to 4 gas components at once: A maximum of three infrared sensitive gases such as CO, CO<sub>2</sub>, NO, SO<sub>2</sub>, CH<sub>4</sub> plus O<sub>2</sub> with an electrochemical oxygen measuring cell.

ULTRAMAT 23 basic versions for:

- 1 infrared gas component with/without oxygen measurement
- 2 infrared gas components with/without oxygen measurement
- 3 infrared gas components with/without oxygen measurement

#### Overview ULTRAMAT 6



The ULTRAMAT 6 single-channel or dual-channel gas analyzers operate according to the NDIR two-beam alternating light principle and measure gases highly selectively whose absorption bands lie in the infrared wavelength range from 2 to 9 μm, such as CO, CO<sub>2</sub>, NO, SO<sub>2</sub>, NH<sub>3</sub>, H<sub>2</sub>O, CH<sub>4</sub> and other hydrocarbons.

Single-channel analyzers measure up to 2 gas components, dual-channel analyzers up to 4 gas components simultaneously.

#### Overview OXYMAT 6



The OXYMAT 6 gas analyzers are based on the paramagnetic alternating pressure method and are used to measure oxygen in gases.

#### Overview OXYMAT 61



The measuring principle of the OXYMAT 61 gas analyzer is based on the paramagnetic alternating pressure method and is used to measure oxygen in gases in standard applications.

#### Overview CALOMAT 6



The CALOMAT 6 gas analyzer is primarily used for quantitative determination of H<sub>2</sub> or He in binary or quasi-binary non-corrosive gas mixtures.

Concentrations of other gases can also be measured if their thermal conductivities differ significantly from the residual gases like Ar, CO<sub>2</sub>, CH<sub>4</sub>, NH<sub>3</sub>.

Additional information is available in catalog PA 01 „Process Analytical Instruments“ and in the Internet under [www.siemens.com/processanalytics](http://www.siemens.com/processanalytics)

# Process analytical instruments

## SITRANS P measuring instruments for pressure

Transmitters for gage, absolute and differential pressure, flow and level

### Overview



SITRANS P pressure transmitters, DS III series, are digital pressure transmitters featuring extensive user-friendliness and high accuracy. The parameterization is performed using control keys, over HART communication, PROFIBUS-PA or Foundation Fieldbus interface.

Extensive functionality enables the pressure transmitter to be precisely adapted to the plant's requirements. Operation is very simple in spite of the numerous setting options.

Transmitters with type of protection "Intrinsic safety" and "Explosion-proof" may be installed within potentially explosive atmospheres (zone 1) or in zone 0. The transmitters are provided with an EC type examination certificate and comply with the corresponding harmonized European standards (ATEX).

The transmitters can be equipped with various designs of remote seals for special applications such as the measurement of highly viscous substances.

Various versions of the DS III pressure transmitters are available for measuring:

- Gage pressure
- Absolute pressure
- For differential pressure transmitters
- Filling level
- Mass
- Volume
- Volume flow
- Mass flow

### Benefits

- High quality and long service life
- High reliability even under extreme chemical and mechanical loads
- For aggressive and non-aggressive gases, vapors and liquids
- Extensive diagnosis and simulation functions
- Separate replacement of measuring cell and electronics without recalibration
- Minimum conformity error
- Small long-term drift

- Wetted parts made of high-grade materials (e.g. stainless steel, Hastelloy, gold, Monel, tantalum)
- Infinitely adjustable span from 0.01 bar to 700 bar (0.15 psi to 10153 psi) for DS III with HART interface
- Nominal measuring range from 1 bar to 700 bar (14.5 psi to 10153 psi) for DS III with PROFIBUS PA and Foundation Fieldbus interface
- High measuring accuracy
- Parameterization over control keys and HART communication, PROFIBUS PA communication or Foundation Fieldbus interface.

### Applications

The pressure transmitters of the DS III series, can be used in industrial areas with extreme chemical and mechanical loads. Electromagnetic compatibility in the range 10 kHz to 1 GHz makes the DS III pressure transmitters suitable for locations with high electromagnetic emissions.

Pressure transmitters with type of protection "Intrinsic safety" and "Explosion-proof" may be installed within potentially explosive atmospheres (zone 1) or in zone 0. The pressure transmitters are provided with an EC type examination certificate and comply with the corresponding harmonized European standards (ATEX).

Pressure transmitters with the type of protection "Intrinsic safety" for use in zone 0 may be operated with power supply units of category "ia" and "ib".

The transmitters can be equipped with various designs of remote seals for special applications such as the measurement of highly viscous substances.

The pressure transmitter can be operated locally over 3 control keys or programmed externally over HART communication or over PROFIBUS PA or Foundation Fieldbus interface

# Process analytical instruments

## SITRANS T temperature measuring devices

### SITRANS TW universal transmitter

#### Overview



#### The user-friendly transmitters for the control room

The SITRANS TW universal transmitter is a further development of the service-proven SITRANS T for the 4-wire system in a mounting rail housing. With numerous new functions it sets new standards for temperature transmitters.

With its diagnostics and simulation functions the SITRANS TW provides the necessary insight during commissioning and operation. And using its HART interface the SITRANS TW can be conveniently adapted with SIMATIC PDM to every measurement task.

All SITRANS TW control room devices are available in a non-intrinsically safe version as well as in an intrinsically safe version for use with the most stringent requirements.

#### Applications

The SITRANS TW transmitter is a four-wire rail-mounted device with a universal input circuit for connection to the following sensors and signal sources:

- Resistance thermometers
- Thermocouple elements
- Resistance-based sensors/potentiometers
- mV sensors
- As special version: V sources, current sources

The 4-wire rail-mounted SITRANS TW transmitter wire is designed for control room installation. It must not be mounted in potentially explosive atmospheres.

All SITRANS TW control room devices are available in a non-intrinsically safe version as well as in an intrinsically safe version for use with the most stringent requirements.

#### Function

##### Features

- Transmitter in four-wire system with HART interface
- Housing can be mounted on 35 mm rail or 32 mm G rail
- Screw plug connector
- All circuits electrically isolated
- Output signal: 0/4 to 20 mA or 0/2 to 10 V
- Power supplies: 115/230 V AC/DC or 24 V AC/DC
- Explosion protection [Ex ia] or [Ex ib] for measurements with sensors in the hazardous area
- Temperature-linear characteristic for all temperature sensors
- Temperature-linear characteristic can be selected for all temperature sensors

- Automatic correction of zero and span
- Monitoring of sensor and cable for open-circuit and short-circuit
- Sensor fault and/or limit can be output via an optional sensor fault/limit monitor
- Hardware write protection for HART communication
- Diagnostic functions
- Slave pointer functions
- SIL 1

#### Mode of operation

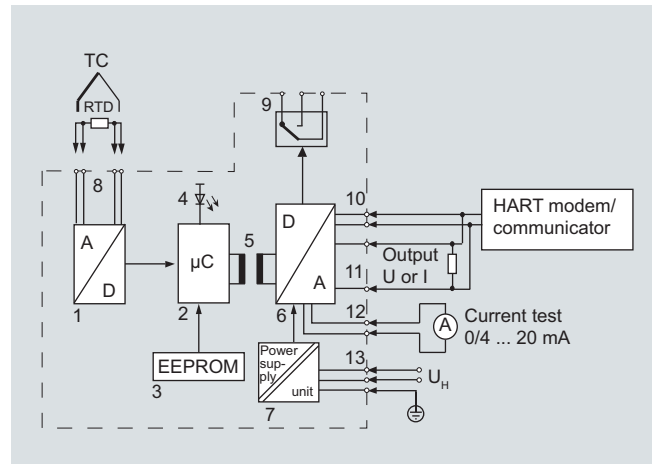

The signal output by a resistance-based sensor (two-wire, three-wire, four-wire system), voltage source, current source or thermocouple is converted by the analog-to-digital converter (1, function diagram) into a digital signal. This is evaluated in the micro controller (2), corrected according to the sensor characteristic, and converted by the digital-to-analog converter (6) into an output current (0/4 to 20 mA) or output voltage (0/2 to 10 V). The sensor characteristics as well as the electronics data and the data for the transmitter parameters are stored in the non-volatile memory (3).

AC or DC voltages can be used as the power supply (13). Any terminal connections are possible for the power supply as a result of the bridge rectifier in the power supply unit. The PE conductor is required for safety reasons.

A HART modem or a HART communicator permit parameterization of the transmitter using a protocol according to the HART specification. The transmitter can be directly parameterized at the point of measurement via the HART output terminals (10).

The operation indicator (4) identifies a fault-free or faulty operating state of the transmitter. The limit monitor (9) enables the signaling of sensor faults and/or limit violations. In the case of a current output, the current can be checked on a meter connected to test socket (12).

#### Diagnosis and simulation functions

The SITRANS TW comes with extensive diagnosis and simulation functions.

Physical values can be defined with the simulation function. It is thus possible to check the complete signal path from the sensor input to inside the control system without additional equipment. The slave pointer functions are used to record the minimum and maximum of the plant's process variable.

# Process analytical instruments

## SITRANS F M flow meters

Transmitter  
MAG 6000 I/6000 I Ex d

### Overview



The SITRANS F M MAG 6000 I/MAG 6000 I Ex d transmitter is designed for the demands in the process industry. The robust die cast aluminium housing provides superb protection, even in the most harsh industrial environments. Full input and output functionality is given even in the Ex version.

### Benefits

- Full range of Ex-rated flowmeters with intrinsically safe rated input and outputs
- For compact or remote installation
- HART, FOUNDATION Fieldbus H1, DeviceNet, PROFIBUS PA and DP, Modbus RTU/RS485 add-on communication modules available
- Superior signal resolution for optimum turn down ratio
- Digital signal processing with many possibilities
- Automatic reading of SENSORPROM data for easy commissioning
- User configurable operation menu with password protection
- 3 lines, 20 characters display in 11 languages
- Flow rate in various units
- Totalizer for forward, reverse and net flow as well as much more information available.
- Multiple functional outputs for process control, minimum configuration with analogue, pulse/frequency and relay output (status, flow direction, limits)
- Comprehensive self-diagnostic for error indication and error logging
- Batch control

### Design

The transmitter is designed for either compact or remote installation in non-hazardous or hazardous areas (compact mounted transmitter to be ordered together with the sensor).

### Function

The following functions are available:

- Flow rate
- 2 measuring ranges
- 2 totalizers
- Low flow cut-off
- Flow direction
- Error system
- Operating time

- Uni-/bidirectional flow
- Limit switches and pulse output
- Batch control

The MAG 6000 I/6000 I Ex d is a microprocessor-based transmitter with a build-in alphanumeric display in several languages. The transmitters evaluate the signals from the associated electromagnetic sensors and also fulfil the task of a power supply unit which provides the magnet coils with a constant current.

Further information on connection, mode of operation and installation can be found in the data sheets for the sensors.

### Displays and keypads

Operation of the transmitter can be carried out using:

- Keypad and display unit
- HART communicator
- PC/laptop and SIMATIC PDM software via HART communication
- PC/laptop and SIMATIC PDM software using PROFIBUS communication

### Technical specifications

Mode of operation and design	
Measuring principle	Electromagnetic with pulsed constant field
Empty pipe	Detection of empty pipe (special cable required in separate mounted installation)
Excitation frequency	Sensor size dependent
Electrode input impedance	$> 1 \times 10^{14} \Omega$
Input	
Digital input	11 ... 30 V DC, $R_i = 4.4 \text{ k}\Omega$
• Activation time	50 ms
• Current	$I_{DC 11 \text{ V}} = 2.5 \text{ mA}$ , $I_{DC 30 \text{ V}} = 7 \text{ mA}$
Output	
Current output	
• Signal range	0 ... 20 mA or 4 ... 20 mA (active/ passive)
• Load	$< 560 \Omega$
• Time constant	0.1 ... 30 s, adjustable
Digital output	
• Frequency	0 ... 10 kHz, 50% duty cycle (uni-/bidirectional)
• Time constant	0.1 ... 30 s, adjustable
• Pulse (passive)	3 ... 30 V DC, max 110 mA (30 mA Ex version), $200 \Omega \leq R_i \leq 10 \text{ k}\Omega$ (powered from connected equipment)
• Time constant	0.1 ... 30 s, adjustable
Relay output	
• Time constant	Changeover relay, same as current output
• Load	42 V AC/2 A, 24 V DC/1 A
Low flow cut off	
	0 ... 9.9% of maximum flow
Galvanic isolation	
	All inputs and outputs are galvanic isolated
Max. measuring error	
• MAG 6000 I/MAG 6000 I Ex d (incl. sensor)	$\pm 0.2 \% \pm 1 \text{ mm/s}$

# Process analytical instruments

## SITRANS F C flow meters

### Transmitter MASS 6000 IP67 compact/remote

#### Overview



MASS 6000 is based on the latest developments within digital signal processing technology – engineered for high performance, fast flow step response, fast batching applications, high immunity against process noise, easy to install, commission and maintain.

The MASS 6000 transmitter delivers true multiparameter measurements i.e. mass flow, volume flow, density, temperature and fraction.

The MASS 6000 IP67 transmitter can be compact mounted on all sensors of type MASS 2100 DI 3 to DI 40, and can be used in remote version for all types of MASS 2100/MC2 and FC300 sensors.

#### Benefits

- Dedicated mass flow chip with the latest ASIC technology
- Fast batching and flow step response with an update rate of true 30 Hz
- Superior noise immunity due to a patented DFT (Discrete Fourier Transformation) algorithm
- Front end resolution better than 0.35 ns improves zero point stability and enhances dynamic turn down ratio on flow and density accuracy
- Advanced diagnosis and service menu enhances trouble shooting and meter verification
- Built-in batch controller with compensation and monitoring comprising 2 built in totalizers
- Multi parameter outputs, individual configurable for mass flow, volume flow, density, temperature or fraction flow such as °BRIX or °PLATO
- Digital input for batch-control, remote zero adjust or forced output mode
- All outputs can be forced to preset value for simulation, verification or calibration purposes
- User configurable operation menu with password protection
  - 3 lines, 20 characters display in 11 languages
  - Self explaining error handling/log in text format
  - Keypad can be used for controlling batch as start/stop/hold/reset
- SENSORPROM technology automatically configures transmitter at start up providing:
  - Factory pre-programming with calibration data, pipe size, sensor type, output settings
  - Any values or settings changed by users are stored automatically
  - Automatically re-programming any new transmitter without loss of accuracy
  - Transmitter replacement in less than 5 minutes. True plug & play

- 4-wire Pt1000 temperature measurement ensures optimum accuracy on mass flow, density and fraction flow
- Fraction flow computation based on 5 order algorithm matching all applications
- USM II platform enables fitting of add-on bus modules without loss of functionality.
  - All modules can be fitted as true "plug & play"
  - Module and transmitter are automatically configured through the SENSORPROM
- Installation of the transmitter to the sensor is simple plug & play via the sensor pedestal

#### Applications

SITRANS F C mass flow meters are suitable for all applications within the entire process industry, where there is a demand for accurate flow measurement. The meter is capable of measuring both liquid and gas flow.

The main applications for the MASS 6000 IP67 transmitter can be found in:

- Food and beverage industries
- Pharmaceutical industries
- Automotive industry
- Oil and gas industry
- Power generation and utility industry
- Water and waste water industry

#### Design

The transmitter is designed in an IP67/NEMA 4X compact polyamide enclosure which can be compact mounted on the MASS 2100 sensor range DI 3 to DI 40 (1/8" to 1½") and remote mounted for the entire sensor series.

The MASS 6000 IP67 is available as standard with 1 current-, 1 frequency/pulse- and 1 relay output and can be fitted with add-on modules for bus communication.

#### Function

The following functions are available:

- Mass flow rate, volume flow rate, density, temperature, fraction flow
- 1 current output, 1 frequency/pulse output, 1 relay output, 1 digital input
- All outputs can be individually configured with mass, volume, density etc.
- 2 built in totalizers which can count positive, negative or net
- Low flow cut-off
- Density cut-off or empty pipe cut-off, adjustable
- Flow direction adjustable
- Error system consisting of error-log, error pending menu
- Display of operating time
- Uni/bidirectional flow measurement
- Limit switches with 1 or 2 limits, programmable for flow, density or temperature
- Noise filter setting for optimization of measurement performance under non ideal application conditions
- Full batch controller
- Automatic zero adjustment menu, with zero point evaluation feed back
- Full service menu for effective and straight forward application and meter trouble shooting

# Process analytical instruments

## SITRANS F C flow meters

### Transmitter MASS 6000 for 19" rack/19" wall mounting

#### Overview



MASS 6000 is based on the latest developments within digital signal processing technology – engineered for high performance, fast flow step response, fast batching applications, high immunity against process noise, easy to install, commission and maintain.

The MASS 6000 transmitter delivers true multi parameter measurements i.e.: Mass flow, volume flow, density, temperature and fraction.

The MASS 6000 19" transmitter can be connected to all sensors of types MASS 2100/MC1/FC300 and are available in different versions depending of number of output facilities, Ex protection and grade of enclosure.

#### Benefits

- Dedicated mass flow chip with the latest ASIC technology
- Fast batching and flow step response with an update rate of true 30 Hz
- Superior noise immunity due to a patented DFT (Discrete Fourier Transformation) algorithm
- Front end resolution better than 0.35 ns improves zero point stability and enhances dynamic turn down ratio on flow and density accuracy
- Advanced diagnosis and service menu enhances trouble shooting and meter verification
- Built in batch controller with compensation and monitoring comprising 2 built in totalizers
- Multi parameter outputs, individual configurable for mass flow, volume flow, density, temperature or fraction flow such as °BRIX or °PLATO
- Many output capacities, up to 3 current outputs, 2 frequency/pulse and 2 relay (excludes the possibility of an add-on module)
- Digital input for batch-control, remote zero adjust or forced output mode
- All outputs can be forced to preset value for simulation, verification or calibration purposes
- User configurable operation menu with password protection
  - 3 lines, 20 characters display in 11 languages
  - Self explaining error handling/log in text format
  - Keypad can be used for controlling batch as start/stop/hold/reset

- SENSORPROM technology automatically configures transmitter at start up providing:
  - Factory pre-programming with calibration data, pipe size, sensor type, output settings
  - Any values or settings changed by users are stored automatically
  - Automatically re-programming any new transmitter without loss of accuracy
  - Transmitter replacement in less than 5 minutes. True plug & play
- 4-wire Pt1000 temperature measurement ensures optimum accuracy on mass flow, density and fraction flow
- Fraction flow computation based on 5 order algorithm matching all applications
- USM II platform enables fitting of add-on bus modules without loss of functionality.
  - All modules can be fitted as true "plug & play"
  - Module and transmitter automatically configured through the SENSORPROM
- Transmitter available with ATEX and UL approval
- All electrical connections are easy accessible on the large back plane PCB

#### Applications

SITRANS F C MASSFLO coriolis mass flow meters are suitable for all applications within the entire process industry, where there is a demand for accurate flow measurement. The meter can measure both liquids and gases.

The main applications for the MASS 6000 19" transmitter can be found in:

- Chemical and pharmaceutical industries
- Food and beverage industries
- Automotive industry
- Oil and gas industry
- Power generation and utility industry
- Water and waste water industry

#### Design

The transmitter is designed as a 19" insert as base to be used in:

- 19" rack system
- Panel mounting IP66/NEMA 4
- Back of panel mounting IP20/NEMA 1
- Wall mounting IP66/NEMA 4

The MASS 6000 19" is available as standard or as ATEX approved transmitter which is to be mounted in the safe area.

# Process analytical instruments

## SITRANS F C flow meters

### Transmitter MASS 6000 Ex-d compact-/remote

#### Overview



MASS 6000 is based on the latest developments within digital signal processing technology – engineered for high performance, fast flow step response, fast batching applications, high immunity against process noise, easy to install, commission and maintain.

The MASS 6000 transmitter delivers true multiparameter measurements i.e.: Mass flow, volume flow, density, temperature and fraction flow.

The MASS 6000 Ex-d transmitter is manufactured in stainless steel (AISI 316L) and able to withstand harsh installation conditions in hazardous applications within the process and chemical industry. The conservative choice of material guarantees the user a low cost of ownership and a long trouble-free lifetime. The Ex-d can be compact mounted on all sensors of type MASS 2100 DI 3 to DI 40, and can be used in remote version for all types of MASS 2100.

#### Benefits

- Fully stainless steel flameproof EEx-d enclosure, ensuring optimum cost of ownership
- Intrinsically safe keypad and display directly programmable in hazardous area
- ATEX approved transmitter which can be mounted in hazardous area Zone 1 or Zone 2
- Sensor and transmitter interface intrinsically safe EEx ia IIC
- Exchange of transmitter directly in hazardous area without shut down of process pipe line due to ia IIC sensor/transmitter interface
- Dedicated mass flow chip with the latest ASIC technology
- Fast batching and flow step response with an update rate of true 30 Hz
- Superior noise immunity due to a patented DFT (Discrete Fourier Transformation) algorithm
- Front end resolution better than 0.35 ns improves zero point stability and enhances dynamic turn down ratio on flow and density accuracy
- Advanced diagnosis and service menu enhances trouble shooting and meter verification
- Built in batch controller with compensation and monitoring comprising 2 built in totalizers
- Multi parameter outputs, individual configurable for mass flow, volume flow, density, temperature or fraction flow such as °BRIX or °PLATO
- 1 current output, 1 frequency/pulse and 1 relay as standard output

- Current output can be selected as passive or active output
- Digital input for batch-control, remote zero adjust or forced output mode
- All outputs can be forced to preset value for simulation, verification or calibration purposes
- User configurable operation menu with password protection
  - 3 lines, 20 characters display in 11 languages
  - Self explaining error handling/log in text format
  - Keypad can be used for controlling batch as start/stop/hold/reset
- SENSORPROM technology automatically configures transmitter at start up providing:
  - Factory pre-programming with calibration data, pipe size, sensor type, output settings
  - Any values or settings changed by users are stored automatically
  - Automatically re-programming any new transmitter without loss of accuracy
  - Transmitter replacement in less than 5 minutes. True plug & play
- 4-wire Pt1000 temperature measurement ensures optimum accuracy on mass flow, density and fraction flow
- Fraction flow computation based on 5 order algorithm matching all applications
- USM II platform enables fitting of add-on bus modules without loss of functionality
  - All modules can be fitted as true "plug & play"
  - Module and transmitter automatically configured through the SENSORPROM
- Installation of the transmitter to the sensor is simple plug & play via the sensor pedestal

#### Application

SITRANS F C mass flow meters are suitable for all applications within the entire process industry where there is a demand for accurate flow measurement in hazardous area. The meter can measure both liquids and gases.

The main applications for the MASS 6000 Ex-d transmitter can be found in:

- Chemical process industry
- Pharmaceutical industries
- Automotive industry
- Oil and gas industry
- Power generation and utility industry

#### Design

The transmitter is designed in an Ex-d compact stainless steel enclosure which can be compact mounted on the MASS 2100 sensor range DI 3 to DI 40, and remote mounted for the entire sensor series.

The MASS 6000 Ex-d is available as standard with 1 current-, 1 frequency/pulse- and 1 relay output and can be fitted with add-on modules for bus communication

- Flameproof „d“ enclosure
- Enclosure stainless steel, IP67/NEMA 4X as compact and IP66/NEMA 4 as remote
- Supply voltage 24 V AC/DC.
- MASS 6000 Ex-d is ATEX approved together with all MASS 2100 sensors



# Process analytical instruments

## SITRANS L level instruments - capacitive switches

Pointek CLS200 - digital version

### Overview

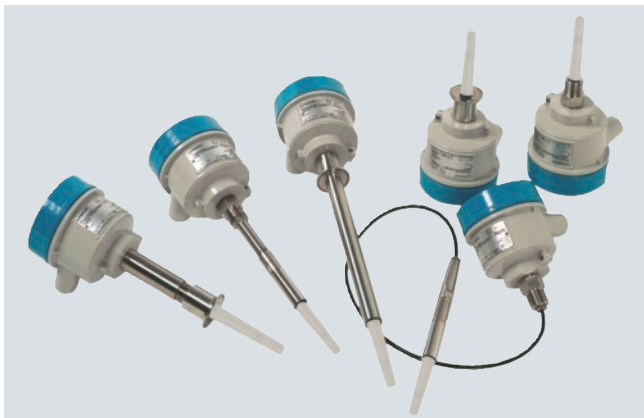

Pointek CLS200 (digital version) is a versatile inverse frequency shift capacitance level switch with optional rod/cable choices and configurable output, ideal for detection of liquids, solids, slurries, foam and interfaces. The digital version includes PROFIBUS PA, an LCD display, and advanced diagnostic features.

### Benefits

- Potted construction protects signal circuit from shock, vibration, humidity and/or condensation
- High chemical resistance
- Level detection independent of tank or pipe earth reference
- Insensitive to product buildup due to high frequency oscillation
- High sensitivity allows installation in a wide range of liquids, solids or slurry applications
- Integral LCD display allows for easy menu-driven setup
- PROFIBUS PA communication (SIMATIC PDM compatible)

### Applications

Pointek CLS200 digital version provides an integral LCD display for stand-alone use, and also provides PROFIBUS PA communication (Profile version 3.0, Class B) for connection to a network. The power supply is galvanically isolated and accepts a wide range of voltages (12 to 30 V DC). When used with thermal isolator, the stainless steel and PPS (PVDF optional) materials used in the probe construction provide a temperature rating up to +125 °C (+257 °F) on the process wetted portion of the probe. The switch responds to any material with a dielectric constant of 1.5 or more by detecting a change in oscillating frequency, and it can be set to detect before contact or on contact with the probe. The menu-driven setup allows precise control of the switch point signal damping and alarm functions.

When connected to the PROFIBUS network, advanced diagnostics and set up using SIMATIC PDM are possible.

The CLS200 operates independently of the tank wall or pipe so it does not require an external reference electrode for level detection in a non-conductive vessel such as concrete or plastic (EMC regulations applicable in some regions).

Key Applications include liquids, slurries, powders, granules, pressurized applications, hazardous areas.

### Configuration

#### Installation

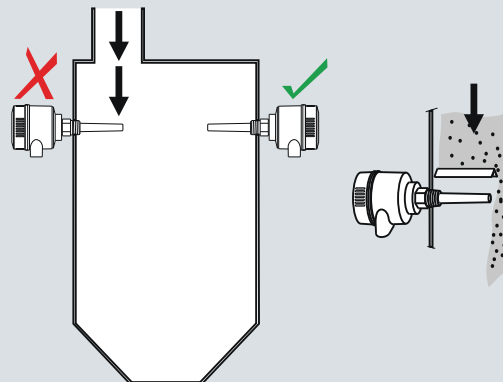

Keep unit out of path of falling material, or protect probe from falling material.



Avoid areas where material build up occurs.

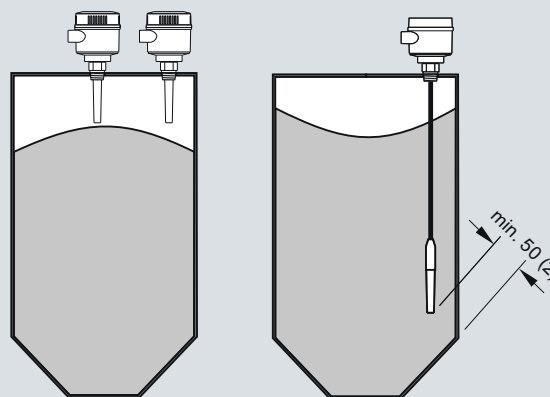

Install probe at least 50 (2") from tank wall.

Pointek CLS 200, installation

# Process analytical instruments

## SITRANS L level instruments - capacitive switches

### Pointek CLS300 - digital version

#### Overview



Pointek CLS300 (digital version) is an inverse frequency shift capacitance level switch with optional rod/cable choices and configurable output. It is ideal for detecting liquids, solids, slurries, foam and interfaces in demanding conditions where high pressure and temperatures are present. The digital version includes PROFIBUS PA, an LCD display, and advanced diagnostic features.

#### Benefits

- Patented Active-Shield technology so measurement is unaffected by material buildup or nozzle interference in active shield section
- Performs in extremely abrasive conditions because of solid rod construction
- Push-button calibration, full-function diagnostics
- High sensitivity allows installation in a wide range of liquids, solids or slurry applications
- Integral LCD display allows for easy menu-driven setup
- PROFIBUS PA communication (SIMATIC PDM compatible)

#### Application

Pointek CLS300 digital version provides an integral LCD display for stand-alone use, with PROFIBUS PA communication (Profile version 3.0, Class B) when required. Solid-state switch alarm is standard.

The robust design of CLS300 makes it specifically applicable for heavy solids applications where abrasive materials occur as in the mining industry.

The fully potted electronics are unaffected by condensation, dust or vibration.

Wetted parts are made of stainless steel with a PFA shield for high chemical resistance, and of ceramic and stainless steel for high temperature version. Materials with low or high dielectric constants can be accurately detected. The unique Active Shield suppresses interference from material buildup or long installation nozzles.

The unique modular design of the Pointek CLS300 provides a wide range of configurations, process connections, extensions and approvals to meet the temperature and pressure requirements of specific applications. The modular design makes ordering easier and reduces stocking requirements. A wide range of probe configurations are available, including rod and cable versions.

Key Applications include liquids, slurries, bulk solids, relatively high pressure and temperature, hazardous areas, milling and mining applications.

#### Configuration

##### Installation

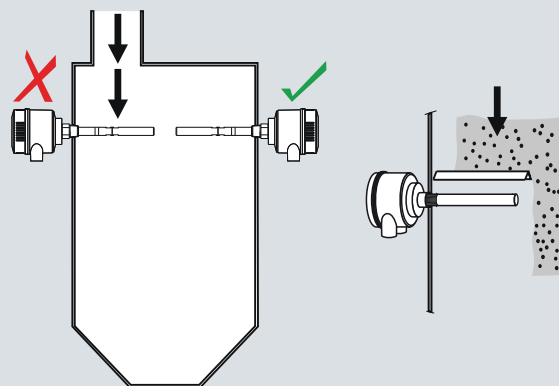

Keep unit out of path of falling material, or protect probe from falling material.

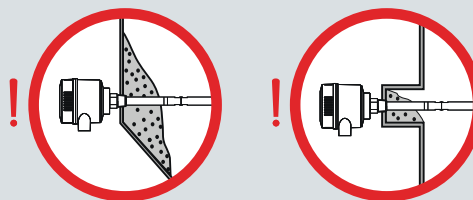

Build up of material in active shield area does not affect switch operation.

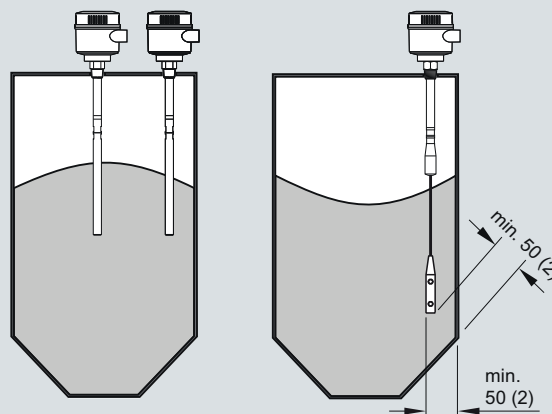

Install probe at least 50 mm (2") from tank wall.  
Note angle of repose and adjust accordingly.

Pointek CLS 300 installation

# Process analytical instruments

## SITRANS L level instruments - capacitive switches

Pointek CLS 500

### Overview



Pointek CLS 500 is an inverse frequency shift capacitance level switch for detecting interfaces, solids, liquids, toxic and aggressive chemicals in critical conditions of high temperature and pressure.

### Benefits

- Patented Active-Shield technology so measurement is unaffected by material buildup in active shield section
- 2-wire loop powered with solid-state switch or 4 to 20/20 to 4 mA output
- Simple push-button calibration and integrated local display
- Full function diagnostics
- HART communications for remote commissioning and inspection

### Application

Patented Active-Shield technology ensures that measurement is unaffected by vapors, product deposits, dust and condensation. The unique mechanical probe design coupled with a high performance transmitter gives superior performance in a wide range of level detection applications.

Pointek CLS 500's microprocessor-based electronics provide one-point calibration, making setup possible without shutting down your production process.

Key Applications include foam or liquid/foam level, glycol regenerators, high-pressure coalescers, LNG applications.

### Configuration

#### Installation

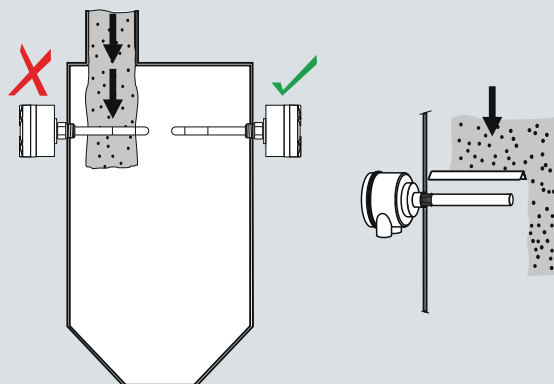

Keep unit out of path of falling material, or protect probe from falling material.

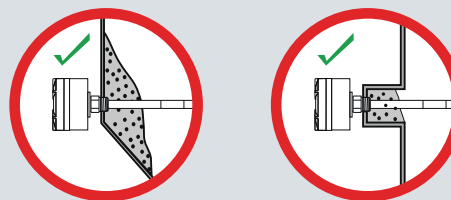

Build up of material in active shield area does not affect switch operation.

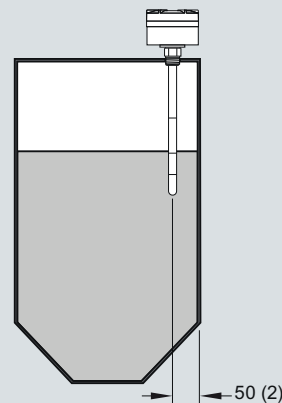

Install probe at least 50 (2) from tank wall.

Pointek CLS 500 installation

# Process analytical instruments

## SITRANS L level instruments - ultrasonic switches

### Pointek ULS 200

#### Overview



The Pointek ULS 200 is an ultrasonic non-contacting switch with two switch points for level detection of bulk solids, liquids and slurries in a wide variety of industries; ideal for sticky materials.

#### Benefits

- 2 switch outputs for high-high, high, low and low-low level alarms or pump up/pump down control
- Integral temperature compensation
- AC or DC power supply
- Electronics provided with fail-safe function
- Threaded and sanitary fitting clamp process connections
- Polycarbonate or aluminum enclosures, Type 6/NEMA 6/IP67
- Easy, two-button programming

#### Application

The measuring range for bulk solids is max. 3 m (9.8 ft) and 5 m (16.4 ft) for liquids and slurries. Unlike invasive contacting devices, there is no material buildup on the sensor.

The level switch has a rugged design, combining the transducer and electronics in one durable device. It has no moving parts and is virtually maintenance-free.

The transducer, available in ETFE or PVDF copolymer, is inert to most chemicals. This means the device can be used in the chemical, petrochemical, water, and wastewater industries. A sanitary version of the ULS200, with an industry standard flange option, is easy to remove from the application for cleaning. It thus satisfies the prerequisites for use in the food, beverage and pharmaceutical industries. The Pointek ULS200 delivers superior performance while reducing maintenance, downtime and equipment replacement costs.

Key Applications include liquids, slurries, fluid materials, plugged chute detection, chemical industry.

#### Design

##### Installation

The Pointek ULS 200 should be mounted in an area that is within the temperature range specified and that is suitable to the enclosure rating and materials of construction. The cover should be accessible to allow programming, wiring and display viewing.

It is advisable to keep the Pointek ULS 200 away from high voltage or current runs, contactors and SCR control drives.

Position the Pointek ULS 200 so that it has a clear sound path perpendicular to the material surface. The sound path should not intersect the fill path, rough walls, seams, rungs, etc.

##### Mounting and Interconnection

The Pointek ULS 200 is available in three thread types: 2" NPT, 2" BSPT or PF2 and can be fitted with the optional 75 mm (3") flange adapter for mating to 3" ASME, DN 65, PN 10 and JIS 10K 3B sized flanges.

Separate cables and conduit may be required to conform to standard instrumentation wiring or electrical codes.

#### Configuration

##### Parabolic Mounting

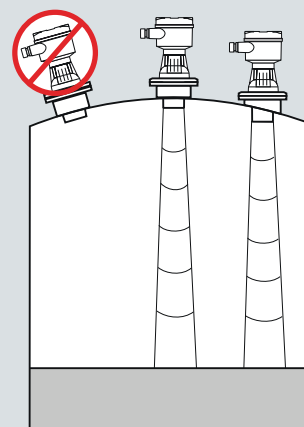

##### Flat Mounting and Beam Angle

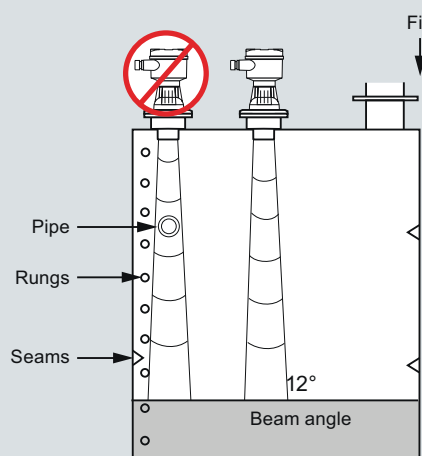

Pointek ULS 200 Mounting

# Process analytical instruments

## SITRANS L level instruments - continuous fill level measurement

SITRANS LR200

### Overview



SITRANS LR200 is a 2-wire, 6 GHz pulse radar level transmitter for continuous monitoring of liquids and slurries in storage and process vessels including high temperature and pressure, to a range of 20 m (66 ft).

### Benefits

- Graphical local user interface (LUI) makes operation simple with plug-and-play setup using the intuitive Quick Start Wizard
- LUI displays echo profiles for diagnostic support
- Communication using HART® or PROFIBUS PA
- Process Intelligence signal processing for improved measurement reliability and Auto False-Echo Suppression of fixed obstructions
- Programming using infrared Intrinsically Safe handheld programmer or SIMATIC PDM

### Application

SITRANS LR200's unique design allows safe and simple programming using the Intrinsically Safe handheld programmer without having to open the instrument's lid. It also features a built-in alphanumeric display in four languages.

The SITRANS LR200 has a standard Uni-Construction polypropylene rod antenna that offers excellent chemical resistance and is hermetically sealed. The Uni-Construction antenna features an internal, integrated shield that eliminates vessel nozzle interference.

Start-up is easy with as few as two parameters for basic operation. Installation is simplified as the electronics are mounted on a rotating head that swivels, allowing the instrument to line up with conduit or wiring connections or simply to adjust the position for easy viewing. SITRANS LR200 features patented Process Intelligence signal-processing technology for superior reliability.

Key Applications include liquid bulk storage tanks, process vessels with agitators, vaporous liquids, high temperatures, asphalt, digesters.

### Configuration

#### Installation

min. 300 mm (1 ft) for every 3 m (10 ft) of vessel wall.

#### Note:

- Beam angle is the width of the cone where the energy density is half of the peak energy density.
- The peak energy density is directly in front of and in line with the rod antenna.
- There is a signal transmitted outside of the beam angle; therefore false targets may be detected.

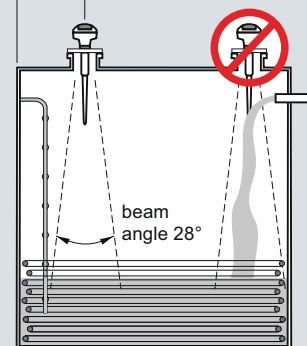

#### Mounting unit on vessel

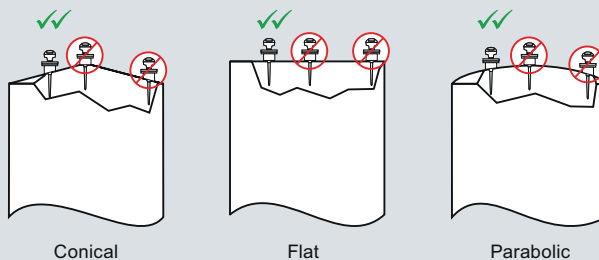

#### Mounting unit on stilling well

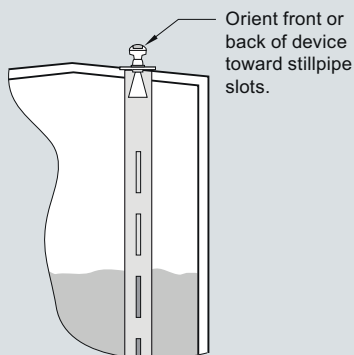

#### Mounting on a nozzle

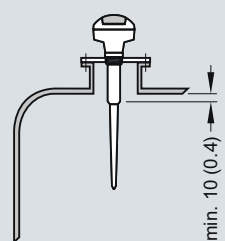

# Process analytical instruments

## SITRANS L level instruments - continuous fill level measurement

### SITRANS LC500

#### Overview



SITRANS LC 500 is an inverse frequency shift capacitance level or interface transmitter for extreme and critical process conditions, such as oil and liquefied natural gas (LNG) as well as toxic and aggressive chemicals and vapors.

#### Benefits

- Patented Active-Shield technology so measurement is unaffected by material buildup in active shield section
- Simple push-button calibration and integrated local display
- Inverse frequency approach provides high resolution
- 2-wire loop powered 4 to 20/20 to 4 mA measurement signal
- Pre-detection alarm and full function diagnostics
- High temperature and pressure resistant (optional)
- Full-function diagnostics comply with NAMUR NE 43
- Easy calibration locally or via HART (using SIMATIC PDM software)

#### Application

SITRANS LC500's advanced electronics provide one-step, push-button calibration and local display for easy on-site installation and setup.

The unique mechanical probe design coupled with a high performance transmitter gives superior performance in toxic and aggressive chemicals, acids, caustics, adhesives and in viscous conductive and non-conductive materials.

The SMART 2-wire transmitter has HART® communications for remote commissioning and inspection.

Key Applications: Oil/water or foam/liquid interface measurement in separators or coalescers, cryogenic applications including CO<sub>2</sub> and liquefied natural gas (LNG), distillation/regeneration tanks with high temperatures

#### Configuration

##### Installation

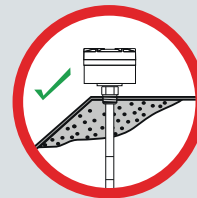

Build up of material or condensation in active shield area does not affect switch operation.

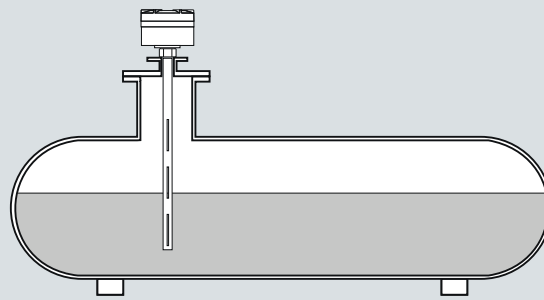

Mounting on non-linear vessels in non-conductive fluids using stilling well.

SITRANS LC500, installation

# Process analytical instruments

## Electropneumatic positioners SIPART PS2

### Technical description

#### Overview

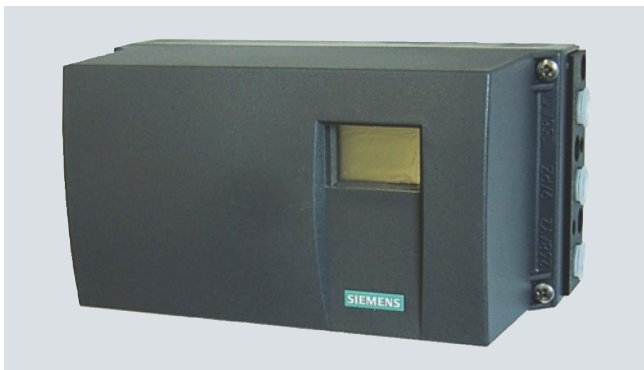

Electropneumatic positioner SIPART PS2 in the Makrolon enclosure



SIPART PS2 Ex d electropneumatic positioner in flameproof aluminium enclosure (Ex d)



SIPART PS2 in stainless steel enclosure

The SIPART PS2 electropneumatic positioner is used to control the final control element of pneumatic linear or part-turn actuators. The electropneumatic positioner moves the actuator to a valve position corresponding to the setpoint. Additional function inputs can be used to block the valve or to set a safety position. A binary input is present as standard in the basic device for this purpose.

#### Benefits

SIPART PS2 positioners offer decisive advantages:

- Simple installation and automatic commissioning (self-adjustment of zero and span)
- Simple operation with
  - Local operation and configuration of the device using three input keys and a user-friendly two-line display
  - Programming through SIMATIC PDM

- Very high-quality control thanks to an online adaptation procedure
- Negligible air consumption in stationary operation
- "Tight shut-off" function (ensures maximum positioning pressure on the valve seat)
- Numerous functions can be activated by simple configuring (e.g. characteristics and limits)
- Extensive diagnostic functions for valve and actuator
- Only one device version for linear and part-turn actuators
- Few moving parts, hence insensitive to vibrations
- External non-contacting position sensor as option for extreme ambient conditions
- "Intelligent solenoid valve": Partial Stroke Test and solenoid valve function in a single device
- Partial Stroke Test, e.g. for safety valves
- Can also be operated with natural gas
- SIL (Safety Integrity Level) 2

#### Application

The SIPART PS2 positioner is used, for example, in the following industries:

- Chemical/petrochemical, power stations
- Paper and glass
- Water, waste water
- Food and pharmaceuticals
- Offshore plants

The SIPART PS2 positioner is available:

- For single-acting actuators: In Makrolon, stainless steel or aluminum enclosure, as well as flameproof aluminum enclosure (Ex d)
- For double-acting actuators: In Makrolon enclosure, stainless steel enclosure and flameproof aluminum enclosure (Ex d)
- For non-hazardous applications
- For hazardous applications in the designs
  - Type of protection intrinsic safety "Ex i"
  - Type of protection flameproof enclosure "Ex d" in flameproof aluminium enclosure
  - Type of protection non-sparking "Ex nA", energy-limited "Ex nL", dust protection via enclosure "Ex tD"

and in the versions:

- With 0/4 to 20 mA control communication through HART signal (as option)
- With PROFIBUS PA communication interface
- With Foundation Fieldbus (FF) communications interface.

#### Explosion-proof versions

The device is available in the following versions for use in atmospheres subject to explosion hazards:

- Flameproof design for use in zone 1 and class I, division 1
- Intrinsically safe design for use in zone 1 and class I, division 1
- Non-sparking and energy-limited design for use in zone 2 and class I, division 2
- Dust-protected design for use in zone 22
- Dust-protected design for use in class II, division 1 and 2 and class III

#### Stainless steel enclosure for extreme ambient conditions

The SIPART PS2 is available in a stainless steel enclosure (with no window in the cover) for use in particularly aggressive environments (e.g. offshore operation, chlorine plants etc.).

The device functions are the same as for the basic version.

# Process analytical instruments

## Electropneumatic positioners SIPART PS2

Technical description

Notes

2



# Evaluating / Communication

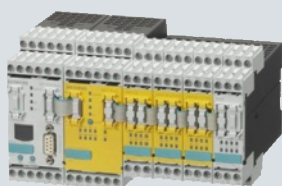

## 3/2 Communication over PROFIBUS/PROFINET

### 3/2 CPUs for factory automation

3/3	CPU 315F-2 DP
3/9	CPU 317F-2 DP
3/15	CPU 315F-2 PN/DP
3/23	CPU 317F-2 PN/DP
3/31	CPU 319F-3 PN/DP
3/40	CPU 317TF-2 DP
3/47	CPU 414F-3 PN/DP
3/50	CPU 416F

### 3/60 CPUs for process automation

3/61	CPU 412-3H
3/67	CPU 414-4H
3/73	CPU 417-4H
3/79	Sync module for interfacing with CPU 41xH
3/80	Y-Link for S7-400H

### 3/83 Configuring

3/83	Distributed safety software
3/84	S7 F/FH Systems
3/86	S7 F Systems
3/87	SIMATIC safety matrix
3/89	Software redundancy

### 3/91 PC-based control

3/91	SIMATIC WinAC RTX F
------	---------------------

### 3/93 SIMATIC ET 200S fail-safe distributed IO

3/93	IM 151-7F-CPU interface module
3/98	IM 151-8F PN/DP CPU interface module
3/105	Master interface module for IM 151-7(8) CPU/F-CPU
3/106	ET 200S - Fail-safe modules
3/106	F power module
	PM-E F PROFIsafe
3/110	F electronic modules
3/114	F electronic module RELAY
3/117	F terminal modules

### 3/119 SIMATIC ET 200pro fail-safe distributed IO

3/121	IM 154-2 DP High Feature
3/124	IM 154-4 PN High Feature
3/127	IM 154-6 PN IWLAN
3/130	IM 154-8 F PN/DP CPU
3/138	Fail-safe digital expansion modules

## 3/139 ET 200M

	<b>fail-safe distributed IO</b>
3/141	F digital/analog modules
3/142	IM 153-2 High Feature interface module
3/147	IM 153-4 High Feature interface module
3/150	SM 326 F digital input - Safety Integrated
3/153	SM 326 F digital output - Safety Integrated
3/156	SM 336 F analog input - Safety Integrated
3/159	Isolation module

## 3/160 SIMATIC ET 200eco fail-safe distributed IO

## 3/167 Communication over AS-Interface

### 3/169 ASIsafe

3/171	AS-Interface safety monitors
3/174	AS-Interface safety modules
3/177	Master for SIMATIC S7: CP 243-2
3/178	Master for SIMATIC S7: CP 343-2P, CP 343-2

### 3/179 Routers

3/179	DP/AS-i LINK Advanced
3/182	DP/AS-Interface Link 20E
3/184	DP/AS-i F-Link
3/187	IE/AS-i LINK PN IO

## 3/190 Conventional design

### 3/190 3RK3 modular safety system

3/195	Engineering software „Modular Safety System ES“
-------	---

### 3/198 3TK28 safety relays

3/199	with relay enabling circuits
3/204	with electronic enabling circuits
3/207	with aux. contactor enabling circuits
3/210	with special functions

## 3/213 SIMOCODE 3UF motor management and control devices

3/220	Basic units
3/221	Expansion modules
3/222	Fail-safe expansion modules

### Delivery time classes (DT)

▶ Preferred type	Preferred types are available immediately from stock, i.e. are dispatched within 24 hours.
A 2 work days	
B 1 week	
C 3 weeks	In exceptional cases the actual delivery time may differ from that specified
D 6 weeks	
X on request	
	The transport times depend on the destination and type of shipping. The standard transport time for Germany is 1 day.
	The delivery times here represent the state of 10/2010.

# Fail-safe automation with SIMATIC CPUs for factory automation

## Fail-safe CPUs

### Overview

- Graded performance spectrum for a wide range of different applications
- 5 fail-safe CPUs (CPU 315F-2 DP, CPU 315F-2 PN/DP, CPU 317F-2 DP, CPU 317F-2 PN/DP, CPU 319F-3 PN/DP)
- 5 CPUs also available for an extended ambient temperature range of  $-25\text{ °C}$  to  $+60\text{ °C}$  (SIPLUS)

Further fail-safe CPUs that can be used with S7-300:

- Distributed fail-safe CPU ET 200S (IM151-7F, IM151-8F)
- Fail-safe software controller WinAC RTX F

### SIPLUS Versions

Some of the fail-safe CPUs are also available as SIPLUS versions.

- SIPLUS CPU 315F-2 DP
- SIPLUS CPU 317F-2 DP
- SIPLUS CPU 315F-2 PN/DP
- SIPLUS CPU 317F-2 PN/DP

These SIPLUS versions are suitable for higher ambient temperatures and harsher environments. The descriptions of the SIPLUS modules are incorporated in the descriptions of the standard versions.

Technical documentation for SIPLUS is available at:

<http://www.siemens.com/siplus-extreme>

### Application

The following fail-safe CPUs are available:

#### PROFIBUS DP

- CPU 315F-2 DP for fail-safe plants with medium to high requirements on the program scope and distributed configuration using PROFIBUS DP
- CPU 317F-2 DP for fail-safe plants with high requirements on the program scope and distributed configuration using PROFIBUS DP

#### PROFIBUS DP and PROFINET IO

- CPU 315F-2 PN/DP for fail-safe plants with medium to high requirements on the program scope and distributed configuration using PROFIBUS DP and PROFINET IO; these can be implemented as distributed intelligence in Component Based Automation (CBA) on PROFINET
- CPU 317F-2 PN/DP for fail-safe plants with high requirements on the program scope and distributed configuration using PROFIBUS DP and PROFINET IO; these can be implemented as distributed intelligence in Component Based Automation (CBA) on PROFINET
- CPU 319F-3 PN/DP for fail-safe plants with very high requirements on the program scope and distributed configuration using PROFIBUS DP and PROFINET IO; these can be implemented as distributed intelligence in Component Based Automation (CBA) on PROFINET

### Additional Information

#### Brochures

You can download information material in the Internet:

<http://www.siemens.com/simatic/printmaterial>

# Fail-safe automation with SIMATIC CPUs for factory automation

## CPU 315F-2 DP

### Overview



- Based on the SIMATIC CPU 315-2 DP
- For setting up a fail-safe automation system in plants with increased safety requirements
- Complies with safety requirements up to SIL 3 according to IEC 61508 and up to Cat. 4 according to EN 954-1
- Distributed fail-safe I/O modules can be connected through the integral PROFIBUS DP interface (PROFIsafe)
- Fail-safe I/O modules of the ET 200M range can also be centrally connected
- Central and distributed use of standard modules for non safety-oriented applications

SIMATIC Micro Memory Card required for operation of CPU.

#### SIPLUS Version

A SIPLUS version of this module is also available.

SIPLUS CPU 315F-2 DP	
Order No.	6AG1 315-6FF04-2AB0
Order No. based on	6ES7 315-6FF04-0AB0
Permitted ambient temperature	-25 ... +60 °C
Permitted relative humidity	5 ... 100 %, condensation is allowed
Suits standard for "Electronic equipment used on rolling stock" (EN 50155, temperature T1, category 1).	No
Conformal coating	Coating material of circuit boards and of electronic circuitry in accordance with EN 60721
Technical data	The technical data are identical with those of the based-on module, except for the ambient conditions.

Technical documentation for SIPLUS is available at:  
<http://www.siemens.com/siplus-extreme>

### Application

The CPU 315F-2 DP permits the design of a fail-safe automation system for plants with increased safety requirements, especially for production engineering.

Distributed I/O stations containing fail-safe I/O modules can be connected through the integrated PROFIBUS DP interface. The fail-safe I/O modules of ET 200M can also be centrally implemented safety-related.

Safety-related communication between the F CPU and the fail-safe I/O modules is performed on the basis of the PROFIsafe profile.

### Design

The CPU 315F-2 DP features the following:

- Microprocessor; the processor achieves a processing time of approximately 50 ns per binary instruction and 0.45 µs per floating-point operation.
- Memory; 384 KB high-speed RAM for safety-relevant and standard program sections; increased memory space requirements must be expected (5 times larger) if safety-relevant program sections are implemented. 128 KB data memory of the 384 KB main memory can be used for standard applications. SIMATIC Micro Memory Cards (max. 8 MB) as load memories for programs additionally permit storage of the project (including symbols and comments) in the CPU.
- Flexible expansion capability; max. 32 modules, (4-tier configuration)
- MPI multi-point interface; the integrated MPI interface can establish as many as 16 connections simultaneously to S7-300/400 or to programming device, PC, OP. Of these connections, one is always reserved for programming devices and another for OPs. The MPI makes it possible to set up a simple network with a maximum of 16 CPUs via "global data communication".
- PROFIBUS DP interface; The CPU 315F-2 DP with PROFIBUS DP master/slave interface allows a distributed automation configuration offering high speed and ease of use. From the user's point of view, the distributed I/O is handled in the same manner as central I/O (identical configuration, addressing and programming). Distributed I/O stations with fail-safe I/O modules can be connected via the integral PROFIBUS DP interface. The fail-safe I/O modules of ET 200M can also be installed in central, safety-related configurations. The safety-oriented communication between the F-CPU and the fail-safe I/O modules is performed on the basis of the PROFIsafe profile.

### Function

- Password protection; a password concept protects the user program from unauthorized access.
- Diagnostics buffer; the last 500 errors and interrupt events are saved in a buffer for diagnostic purposes.
- Maintenance-free data back-up; all standard data is automatically written onto the SIMATIC Micro Memory Card by the CPU if there is a voltage interruption, and is available unchanged following voltage recovery.

#### Parameterizable properties

The S7 configuration as well as the properties and response of the CPUs can be parameterized using STEP 7:

- MPI multi-point interface; determining station addresses
- Restart/cycle time behavior; stipulation of maximum cycle time and loading as well as self-test functions
- Clock memory; setting of addresses
- Protection level; specifying the access rights to program and data

# Fail-safe automation with SIMATIC CPUs for factory automation

## CPU 315F-2 DP

- System diagnostics; determining handling and scope of the diagnostic alarms
- Watchdog interrupts; setting of periodicity
- Clock interrupts; setting of start date, start time and periodicity
- PROFIBUS DP master/slave interface; user-defined address assignment for distributed I/O

### Display and information functions

- Status and error indications; LEDs indicate hardware, programming, time or I/O errors, and operating statuses such as RUN, STOP and start-up.
- Test functions; the PG is used to indicate signal status during program execution, to modify process variables independently of the user program and to output the contents of stack memories.
- Information functions; you can use the PG to obtain information about the storage capacity and operating mode of the CPU, the current utilization of the main and load memories as well as current cycle times and diagnostic buffer contents in plain text.

### Integrated communication functions

- PG/OP communication
- Global data communication
- S7 basic communication
- S7 communication (server only)
- Routing
- Data block routing

### Communication

The safety-related and standard communication between the central controller and the distributed stations is performed via PROFIBUS DP. The specially developed PROFIBUS profile *PROF/safe* allows user data for the safety function to be transferred within the standard data message frame. Additional hardware components, such as special safety buses, are not necessary. The necessary software is either integrated in the hardware components as an expansion of the operating system or it is loaded into the CPU as a certified software block.

### System functions

The CPU provides many extensive system functions for diagnostics, parameterization, synchronization, alerting, time measurement, etc.

For further details, see the manual.

### Mode of operation

The safety functions of the F-CPU are included in the F program of the CPU and in the fail-safe signal modules.

The signal modules monitor the input and output signals through discrepancy analyses and the application of test signals.

The CPU checks that the controller is operating correctly by means of periodic self-tests, test instructions as well as logical and time-based program execution checks. The I/O is checked with requests for a sign of life.

If an error is diagnosed in the system, it is transferred to a safe state.

An F runtime license is not required for operating the S7-300F-2 DP.

### Programming

The S7-300F is programmed in the same manner as the other SIMATIC S7 systems. The user program for non fail-safe system components is created using the familiar programming tools, e.g. STEP 7.

### SIMATIC S7 Distributed Safety option package

The STEP 7 option package "SIMATIC S7 Distributed Safety" is required for programming the safety-related program sections. The package contains all the functions and blocks required to create the F program.

The F program with the safety functions is created in F-FBD or F-LAD or using special function blocks from the F library. Use of F-FBD or F-LAD simplifies configuration and programming of the plant and, due to the cross-plant, uniform presentation, also acceptance testing. The programmer can therefore concentrate entirely on configuring the safety-related application, without the need to use any additional tools.

# Fail-safe automation with SIMATIC

## CPUs for factory automation

CPU 315F-2 DP

### Technical specifications

Order No.	6ES7 315-6FF04-0AB0
<b>Product version</b> associated programming package	STEP 7 > V 5.4 + SP5 or STEP 7 as of V5.2 + SP1 with HSP 177, S7 Distributed Safety as of V5.4
<b>Supply voltages</b> Rated value • permissible range, lower limit (DC)	20.4 V
External protection for supply cables (recommendation)	Min. 2 A
<b>Current consumption</b> Current consumption (rated value)	850 mA
Current consumption (in no-load operation), typ.	150 mA
Inrush current, typ.	3.5 A
$I^2t$	1 A <sup>2</sup> -s
from supply voltage L+, max.	900 mA
<b>Power losses</b> Power loss, typ.	4.5 W
<b>Memory</b> Work memory • integrated • expandable • Size of retentive memory for retentive data blocks	384 Kbyte No 128 Kbyte
Load memory • pluggable (MMC) • pluggable (MMC), max.	Yes 8 Mbyte
Backup • present  • without battery	Yes; guaranteed by MMC (maintenance-free) Yes; Program and data
<b>CPU-blocks</b> DB • Number, max.  • Size, max.	1 024; Number range: 1 to 16000 64 Kbyte
FB • Number, max.  • Size, max.	1 024; Number range: 0 to 7999 64 Kbyte
FC • Number, max.  • Size, max.	1 024; Number range: 0 to 7999 64 Kbyte
OB • Size, max.	64 Kbyte
Nesting depth • per priority class • additional within an error OB	16 4
<b>CPU processing times</b> for bit operations, min.	0.05 µs
for word operations, min.	0.09 µs
for fixed point arithmetic, min.	0.12 µs
for floating point arithmetic, min.	0.45 µs
<b>Counters, timers and their retentivity</b> S7 counter • Number • Retentivity - can be set - lower limit - upper limit	256 Yes 0 255

Order No.	6ES7 315-6FF04-0AB0
• Counting range - can be set - lower limit - upper limit	Yes 0 999
IEC counter • present • Type	Yes SFB
S7 times • Number • Retentivity - can be set - lower limit - upper limit - preset • Time range - lower limit - upper limit	256 Yes 0 255 no retentivity 10 ms 9 990 s
IEC timer • present • Type	Yes SFB
<b>Data areas and their retentivity</b> Flag • Number, max. • Retentivity available • Number of clock memories	2 048 byte Yes; MB 0 to MB 2047 8; 1 memory byte
Data blocks • Number, max.  • Size, max. • Retentivity adjustable • Retentivity preset	1 024; Number range: 1 to 16000 64 Kbyte Yes; via non-retain property on DB yes
Local data • per priority class, max.	32 Kbyte; max. 2 KB per block
<b>Address area</b> I/O address area • overall • Outputs • of which, distributed - Inputs - Outputs	2 048 byte 2 048 byte 2 048 byte 2 048 byte
Process image • Inputs • Outputs • Inputs, adjustable • Outputs, adjustable • Inputs, default • Outputs, default	2 048 byte 2 048 byte 2 048 byte 2 048 byte 384 byte 384 byte
Subprocess images • Number of subprocess images, max.	1
Digital channels • Inputs • Outputs • Inputs, of which central • Outputs, of which central	16 384 16 384 1 024 1 024
Analog channels • Inputs • Outputs • Inputs, of which central • Outputs, of which central	1 024 1 024 256 256
<b>Hardware configuration</b> Central devices, max.  Expansion devices, max.	1  3

# Fail-safe automation with SIMATIC

## CPUs for factory automation

### CPU 315F-2 DP

Order No.	6ES7 315-6FF04-0AB0
Racks, max.	4
Modules per rack, max.	8
Number of DP masters	
• integrated	1
• via CP	4
Number of operable FMs and CPs (recommended)	
• FM	8
• CP, point-to-point	8
• CP, LAN	10
<b>Time of day</b>	
Clock	
• Hardware clock (real-time clock)	Yes
• battery-backed and synchronizable	Yes
• Behavior of the clock following expiry of backup period	The clock continues at the time of day it had when power was switched off
• Deviation per day, max.	10 s; typ.: 2 s
Runtime meter	
• Number	1
• Number/Number range	0
• Range of values	0 to 2 <sup>31</sup> hours (when using SFC 101)
• Granularity	1 hour
• retentive	Yes; must be restarted at each restart
Clock synchronization	
• supported	Yes
• to MPI, master	Yes
• to MPI, slave	Yes
• to DP, master	Yes; on DP slave only time-of-day slave
• to DP, slave	Yes
• in AS, master	Yes
<b>S7 message functions</b>	
Number of login stations for message functions, max.	16; Depending on the connections configured for PG/OP and S7 basic communication
Process diagnostic messages	Yes
simultaneously active Alarm-S blocks, max.	300
<b>Test commissioning functions</b>	
Status/control	
• Status/control variable	Yes
• Variables	Inputs, outputs, memory bits, DB, times, counters
• Number of variables, max.	30
• of which status variables, max.	30
• of which control variables, max.	14
Forcing	
• Forcing	Yes
Status block	Yes; up to 2 simultaneously
Single step	Yes
Number of breakpoints	4
Diagnostic buffer	
• present	Yes
• Number of entries, max.	500
- can be set	No
- Of which powerfail-proof	100; only the last 100 entries are retained
• Number of entries readable in RUN, max.	
- adjustable	Yes; From 10 to 499
- preset	10

Order No.	6ES7 315-6FF04-0AB0
<b>Monitoring functions</b>	
Status LEDs	Yes
<b>Communication functions</b>	
PG/OP communication	Yes
Data record routing	Yes
Routing	Yes; max. 4
Global data communication	
• supported	Yes
• Size of GD packets, max.	22 byte
S7 basic communication	
• supported	Yes
S7 communication	
• supported	Yes
S5-compatible communication	
• supported	Yes; via CP and loadable FC
Number of connections	
• overall	16
• usable for PG communication	15
• usable for OP communication	15
• usable for S7 basic communication	12
<b>1st interface</b>	
Type of interface	Integrated RS 485 interface
Physics	RS 485
Isolated	No
Power supply to interface (15 to 30 V DC), max.	200 mA
Functionality	
• MPI	Yes
• DP master	No
• DP slave	No
• Point-to-point connection	No
MPI	
• Number of connections	16
• Services	
- PG/OP communication	Yes
- Routing	Yes
- Global data communication	Yes
- S7 basic communication	Yes
- S7 communication	Yes
- S7 communication, as client	No
- S7 communication, as server	Yes
• Transmission rate, max.	187.5 kbit/s
<b>2nd interface</b>	
Type of interface	integrated RS 485 interface
Physics	RS 485
Isolated	Yes
Power supply to interface (15 to 30 V DC), max.	200 mA
Functionality	
• MPI	No
• DP master	Yes
• DP slave	Yes
• Local Operating Network	No
DP master	
• Number of connections, max.	16
• Services	
- PG/OP communication	Yes
- Routing	Yes
- Global data communication	No
- S7 basic communication	Yes; I blocks only
- S7 communication	Yes

# Fail-safe automation with SIMATIC

## CPUs for factory automation

### CPU 315F-2 DP

Order No.	6ES7 315-6FF04-0AB0
- S7 communication, as client	No
- S7 communication, as server	Yes
- Equidistance mode support	Yes
- Isochronous mode	Yes; OB 61
- SYNC/FREEZE	Yes
- Activation/deactivation of DP slaves	Yes
- Number of DP slaves that can be simultaneously activated/deactivated, max.	8
- DPV1	Yes
• Transmission rate, max.	12 Mbit/s
• Number of DP slaves, max.	124; per station
• Address area	
- Inputs, max.	2 048 byte
- Outputs, max.	2 048 byte
• User data per DP slave	
- Inputs, max.	244 byte
- Outputs, max.	244 byte
DP slave	
• Number of connections	16
• Services	
- PG/OP communication	Yes
- Routing	Yes; only with active interface
- Global data communication	No
- S7 basic communication	No
- S7 communication, as client	No
- S7 communication, as server	Yes
- Direct data exchange (slave-to-slave communication)	Yes
- DPV1	No
• GSD file	The current GSD file can be obtained from: <a href="http://www.siemens.com/profibus-gsd">http://www.siemens.com/profibus-gsd</a>
• Transmission rate, max.	12 Mbit/s
• Automatic baud rate search	Yes; only with passive interface
• Transfer memory	
- Inputs	244 byte
- Outputs	244 byte
• Address area, max.	32
• User data per address area, max.	32 byte
<b>Isochronous mode</b>	
Isochronous mode	Yes
<b>programming</b>	
Programming language	
• STEP 7	Yes; V5.2 SP1 or higher with HW update
• LAD	Yes
• FBD	Yes
• STL	Yes
• SCL	Yes
• CFC	Yes
• GRAPH	Yes
• HiGraph®	Yes
Command set	See instruction list
Nesting levels	8
Know-how protection	
• User program protection/password protection	Yes
System functions (SFC)	see instruction list
System function blocks (SFB)	see instruction list

Order No.	6ES7 315-6FF04-0AB0
<b>Dimensions and weight</b>	
Dimensions	
• Width	40 mm
• Height	125 mm
• Depth	130 mm
Weight	
• Weight, approx.	290 g

# Fail-safe automation with SIMATIC

## CPUs for factory automation

### CPU 315F-2 DP

#### Selection and ordering data

	Order No.
<b>CPU 315F-2 DP</b> CPU for SIMATIC S7-300F; 384 KB RAM, power supply 24 V DC, MPI, PROFIBUS DP master/slave interface, incl. slot number labels; MMC required	<b>6ES7 315-6FF04-0AB0</b>
<b>SIPLUS CPU 315F-2 DP</b> For constructing a fail-safe automation system. Suitable for exceptional medial exposure.	<b>6AG1 315-6FF04-2AB0</b>
<b>Distributed Safety V5.4 programming tool</b> Task: Software for configuring fail- safe user programs for SIMATIC S7-300F, S7-400F, ET 200S Requirement: STEP 7 V5.3 SP3 and higher  Floating license Software Update Service	<b>6ES7 833-1FC02-0YA5</b> <b>6ES7 833-1FC00-0YX2</b>
<b>Distributed Safety Upgrade</b> From V5.x to V5.4; Floating license for 1 user	<b>6ES7 833-1FC02-0YE5</b>
<b>SIMATIC Micro Memory Card</b> 64 KB 128 KB 512 KB 2 MB 4 MB 8 MB	<b>6ES7 953-8LF20-0AA0</b> <b>6ES7 953-8LG20-0AA0</b> <b>6ES7 953-8LJ20-0AA0</b> <b>6ES7 953-8LL20-0AA0</b> <b>6ES7 953-8LM20-0AA0</b> <b>6ES7 953-8LP20-0AA0</b>
<b>MPI cable</b> for connection of SIMATIC S7 and PG via MPI; 5 m in length	<b>6ES7 901-0BF00-0AA0</b>
<b>Slot number plates</b>	<b>6ES7 912-0AA00-0AA0</b>
<b>S7-300 manual</b> Design, CPU data, module data, instruction list  German English French Spanish Italian	<b>6ES7 398-8FA10-8AA0</b> <b>6ES7 398-8FA10-8BA0</b> <b>6ES7 398-8FA10-8CA0</b> <b>6ES7 398-8FA10-8DA0</b> <b>6ES7 398-8FA10-8EA0</b>
<b>SIMATIC Manual Collection</b> Electronic manuals on DVD, multi- lingual: LOGO!, SIMADYN, SIMATIC bus components, SIMATIC C7, SIMATIC distributed I/O, SIMATIC HMI, SIMATIC Sensors, SIMATIC NET, SIMATIC PC Based Automation, SIMATIC PCS 7, SIMATIC PG/PC, SIMATIC S7, SIMATIC Software, SIMATIC TDC	<b>6ES7 998-8XC01-8YE0</b>
<b>SIMATIC Manual Collection update service for 1 year</b> Current "Manual Collection" DVD and the three subsequent updates	<b>6ES7 998-8XC01-8YE2</b>
<b>Power supply connector</b> 10 units, spare part	<b>6ES7 391-1AA00-0AA0</b>

	Order No.
<b>Manual "Communication for SIMATIC S7-300/-400"</b>  German English French Spanish Italian	<b>6ES7 398-8EA00-8AA0</b> <b>6ES7 398-8EA00-8BA0</b> <b>6ES7 398-8EA00-8CA0</b> <b>6ES7 398-8EA00-8DA0</b> <b>6ES7 398-8EA00-8EA0</b>
<b>PC adapter USB</b> for connecting a PC to SIMATIC S7-200/300/400 via USB; with USB cable (5 m)	<b>6ES7 972-0CB20-0XA0</b>
<b>PROFIBUS DP bus connector RS 485</b> <ul style="list-style-type: none"><li>• with 90° cable outlet, max. transfer rate 12 Mbit/s - without PG interface</li><li>- with PG interface</li><li>• with 90° cable outlet for FastConnect connection system, max. transfer rate 12 Mbit/s - without PG interface, 1 unit</li><li>- without PG interface, 100 units</li><li>- with PG interface, 1 unit</li><li>- with PG interface, 100 units</li><li>• with axial cable outlet for SIMATIC OP, for connecting to PPI, MPI, PROFIBUS</li></ul>	<b>6ES7 972-0BA12-0XA0</b> <b>6ES7 972-0BB12-0XA0</b>  <b>6ES7 972-0BA52-0XA0</b> <b>6ES7 972-0BA52-0XB0</b> <b>6ES7 972-0BB52-0XA0</b> <b>6ES7 972-0BB52-0XB0</b> <b>6GK1 500-0EA02</b>
<b>PROFIBUS Fast Connect bus cable</b> Standard type with special design for quick mounting, 2-core, shielded, sold by the meter, max. delivery unit 1000 m, minimum ordering quantity 20 m	<b>6XV1 830-0EH10</b>
<b>RS 485 repeater for PROFIBUS</b> Transfer rate up to 12 Mbit/s; 24 V DC; IP20 enclosure	<b>6ES7 972-0AA01-0XA0</b>
<b>PROFIBUS bus components</b> for establishing MPI/PROFIBUS communication	<b>see Catalogs IK PI, CA 01</b>



# Fail-safe automation with SIMATIC CPUs for factory automation

## CPU 317F-2 DP

### Overview



- The fail-safe CPU with a large program memory and quantity framework for demanding applications
- For constructing a fail-safe automation system for plants with increased safety requirements
- Satisfies safety requirements up to SIL 3 acc. to IEC 61508 and up to Cat. 4 acc. to EN 954-1
- Fail-safe I/O modules can be connected in a distributed configuration to both integral PROFIBUS DP interfaces (PROFIsafe)
- Fail-safe I/O modules of the ET 200M range can also be centrally connected
- Central and distributed use of standard modules for non safety-relevant applications

SIMATIC Micro Memory Card required for operation of CPU.

### SIPLUS Versions

SIPLUS versions of this module are also available.

SIPLUS CPU 317F-2 DP		
<b>Order No.</b>	<b>6AG1 317-6FF03-2AB0</b>	<b>6AG1 317-6FF03-2AY0</b>
<b>Order No. based on</b>	<b>6ES7 317-6FF03-0AB0</b>	
Permitted ambient temperature	-25 ... +60 °C	
Permitted relative humidity	5 ... 100 %, condensation is allowed	
Suits standard for "Electronic equipment used on rolling stock" (EN 50155, temperature T1, category 1).	No	Yes
Conformal coating	Coating material of circuit boards and of electronic circuitry in accordance with EN 60721	
Technical data	The technical data are identical with those of the based-on module, except for the ambient conditions.	

Technical documentation for SIPLUS is available at:  
<http://www.siemens.com/siplus-extreme>

### Application

The CPU 317F-2 DP allows a fail-safe automation system to be implemented for plants with increased safety requirements, especially in manufacturing automation.

Distributed I/O stations containing fail-safe I/O modules can be connected through the two integrated PROFIBUS DP interfaces. The fail-safe I/O modules of ET 200M can also be installed in central and safety-related configurations.

The safety-oriented communication between the F-CPU and the fail-safe I/O modules is performed on the basis of the PROFIsafe profile.

A SIMATIC Micro Memory Card is required for operation of the CPU.

### Design

The CPU 317F-2 DP is equipped with the following:

- **Microprocessor:**  
The processor achieves an execution time of approximately 100 ns per binary instruction and 2 µs per floating-point operation. The CPU317F-2 DP is clearly superior in terms of processing speed, particularly where word or double-word commands and 32 bit fixed-point commands are concerned.
- **Memory:**  
1024 KB high-speed RAM for safety-relevant and standard program sections; increased memory space requirements must be expected (5 times larger) if safety-relevant program sections are implemented. SIMATIC Micro Memory Cards (8 MB max.) as load memory for the program also allow the project to be stored in the CPU (complete with symbols and comments) and can be used for data archiving and recipe management.
- **Flexible expansion up to 32 modules (four-tier configuration)**
- **Combined MPI/DP interface:**  
The first MPI/DP integrated interface can establish as many as 32 connections simultaneously to S7-300/400 or connections to programming device, PC, OP. Among these connections, one is always reserved for programming devices and another for OPs. A simple network with up to 32 CPUs can be configured with the MPI interfaces and "global data communication".
- **The MPI interface can be reconfigured from an MPI to a DP interface.** The DP interface can be used as a DP master or as a DP slave.
- **PROFIBUS DP interface:**  
The second integrated interface of the CPU 317F-2 DP is a pure PROFIBUS DP interface that can be used as a DP master or as a DP slave. It allows a distributed automation configuration with high speeds and simple handling. From the user's point of view, the distributed I/Os are treated the same as central I/Os (identical configuration, addressing and programming). The PROFIBUS DP V1 standard is supported in full. This increases the scope of DP V1 standard slaves in terms of diagnostics and parameterization capability.  
Limitation: It is impossible to operate both interfaces simultaneously as slaves.

Distributed I/O stations containing fail-safe I/O modules can be connected through the two integrated PROFIBUS DP interfaces. The fail-safe I/O modules of ET 200M can also be installed in central and safety-related configurations. The fail-safe I/O modules of ET 200M can also be centrally implemented. Safety-related communication is performed over PROFIBUS DP with the PROFIsafe profile.

### Function

- **Password protection;**  
a password concept protects the user program from unauthorized access.
- **Diagnostics buffer;**  
the last 100 errors and interrupt events are saved in a buffer for diagnostics purposes.
- **Maintenance-free data backup;**  
the CPU automatically saves all data in case of power failure so that the data are available again unchanged when the power returns

# Fail-safe automation with SIMATIC CPUs for factory automation

## CPU 317F-2 DP

### Configurable attributes

STEP 7 can be used to parameterize both S7 configurations and the properties and responses of the CPUs:

- MPI multipoint interface; determination of node addresses.
- Restart/cycle time behavior; stipulation of maximum cycle time and loading.
- Clock bit memory; address setting
- Protection level; definition of access rights to program and data.
- System diagnostics; definition of the handling and scope of diagnostics messages.
- Watchdog interrupts; setting of periodicity
- Time-of-day interrupts; setting of date and time of start and periodicity
- PROFIBUS DP master/slave interface; user-oriented address allocation for distributed I/O.

### Indication and information functions

- Status and error indications; LEDs indicate e.g. hardware, programming, time, I/O or bus errors, as well as operating states such as RUN, STOP and restart
- Test functions; the PG can be used to display signal states in program execution, modify process variables independently of the user program, and read out the contents of stack memories.
- Information functions; you can use the PG to obtain information about the storage capacity and operating mode of the CPU as well as the current loading of the main and load memories, current cycle times and diagnostic buffer contents in plain text.

### Integrated communication functions

- PG/OP communication
- Global data communication
- S7 basic communication
- S7 communication (server only)

### Sequential function chart

The CPU provides many extensive system functions for diagnostics, parameterization, synchronization, alerting, time measurement, etc.

Details can be found in the manual.

### Communication

The safety-related communication and standard communication between the central controller and the distributed stations is conducted over PROFIBUS DP. The specially developed PROFIBUS profile PROFIsafe allows the transmission of user data associated with the safety function within the standard data telegram. Additional hardware components, e.g. special safety buses, are unnecessary. The required software is either integrated in the hardware components as an extension of the operating system, or must be loaded into the CPU as a certified software component.

### Mode of operation

The safety functions of the F CPU are contained in the CPU's F program and in the fail-safe signal modules. The signal modules monitor the output and input signals by means of discrepancy analyses and test signal injections. The CPU monitors proper operation of the PLC by performing regular self-tests, instruction tests and logic and sequential program flow control. In addition, the I/O is checked by requesting signs of life. If an error is diagnosed on the system, the latter is moved to a safe state. An F runtime license is not required for operation of the CPU 317F-2 DP.

### Programming

The CPU 317F-2 DP is programmed in the same manner as other SIMATIC S7 systems. The user program for non fail-safe plant sections is created with the proven programming tools such as STEP 7.

### SIMATIC S7 Distributed Safety option package

The "S7 F Distributed Safety" option package is required to program the safety-relevant parts of the program. The package contains all the functions and blocks required to create the F program. The F program with the safety functions is linked in F-FBD or F-LAD or using special function blocks from the F library. Use of F-FBD or F-LAD simplifies plant planning and programming and, because of the uniform and cross-vendor presentation, the acceptance test too. Programmers can concentrate completely on configuration of the safety-relevant application without having to use additional tools.

### Technical specifications

Order No.	6ES7 317-6FF03-0AB0
<b>Product version</b>	
associated programming package	STEP 7 V5.2 SP1 with hardware update or higher; S7 Distributed Safety 5.2 SP1 or higher
<b>Supply voltages</b>	
Rated value	
• permissible range, lower limit (DC)	20.4 V
external protection for supply cables (recommendation)	Min. 2 A
<b>Current consumption</b>	
Current consumption (in no-load operation), typ.	100 mA
Inrush current, typ.	2.5 A
$I^2t$	1 A <sup>2</sup> s
<b>Power losses</b>	
Power loss, typ.	4 W
<b>Memory</b>	
Work memory	
• integrated	1 024 Kbyte
• expandable	No
Load memory	
• pluggable (MMC)	Yes
• pluggable (MMC), max.	8 Mbyte
Backup	
• present	Yes; guaranteed by MMC (maintenance-free)
• without battery	Yes; Program and data
<b>CPU-blocks</b>	
DB	
• Number, max.	2 047; Number band: 1 to 2047
• Size, max.	64 Kbyte
FB	
• Number, max.	2 048; Sequence of numbers: 0 to 2047
• Size, max.	64 Kbyte
FC	
• Number, max.	2 048; Sequence of numbers: 0 to 2047
• Size, max.	64 Kbyte
OB	
• Size, max.	64 Kbyte
Nesting depth	
• per priority class	16
• additional within an error OB	4
<b>CPU processing times</b>	
for bit operations, min.	0.05 µs

# Fail-safe automation with SIMATIC

## CPUs for factory automation

### CPU 317F-2 DP

Order No.	6ES7 317-6FF03-0AB0
for word operations, min.	0.2 µs
for fixed point arithmetic, min.	0.2 µs
for floating point arithmetic, min.	1 µs
<b>Counters, timers and their retentivity</b>	
S7 counter	
• Number	512
• of which retentive without battery	Yes
- can be set	
• Retentivity	Yes
- can be set	
- lower limit	0
- upper limit	511
• Counting range	Yes
- can be set	
- lower limit	0
- upper limit	999
IEC counter	
• present	Yes
• Type	SFB
S7 times	
• Number	512
• Retentivity	Yes
- can be set	
- lower limit	0
- upper limit	511
- preset	no retentivity
• Time range	
- lower limit	10 ms
- upper limit	9 990 s
IEC timer	
• present	Yes
• Type	SFB
<b>Data areas and their retentivity</b>	
Flag	
• Number, max.	4 096 byte
• Retentivity available	Yes; MB 0 to MB 4095
• Number of clock memories	8; 1 memory byte
Data blocks	
• Number, max.	2 047; from DB 1 to DB 2047
• Size, max.	64 Kbyte
• Retentivity adjustable	Yes; via non-retain property on DB
• Retentivity preset	yes
Local data	
• per priority class, max.	1 024 byte
<b>Address area</b>	
I/O address area	
• overall	8 Kbyte
• Outputs	8 Kbyte
• of which, distributed	
- Inputs	8 Kbyte
- Outputs	8 Kbyte
Process image	
• Inputs	1 024 byte
• Outputs	1 024 byte
Digital channels	
• Inputs	65 536
• Outputs	65 536
• Inputs, of which central	1 024
• Outputs, of which central	1 024
Analog channels	
• Inputs	4 096
• Outputs	4 096
• Inputs, of which central	256
• Outputs, of which central	256

Order No.	6ES7 317-6FF03-0AB0
<b>Hardware configuration</b>	
Central devices, max.	1
Expansion devices, max.	3
Racks, max.	4
Modules per rack, max.	8
Number of DP masters	
• integrated	2
• via CP	4
Number of operable FMs and CPs (recommended)	
• FM	8
• CP, point-to-point	8
• CP, LAN	10
<b>Time of day</b>	
Clock	
• Hardware clock (real-time clock)	Yes
• battery-backed and synchronizable	Yes
• Deviation per day, max.	10 s
Runtime meter	
• Number	4
• Number/Number range	0 to 3
• Range of values	0 to 2 <sup>31</sup> hours (when using SFC 101)
• Granularity	1 hour
• retentive	Yes; must be restarted at each restart
Clock synchronization	
• supported	Yes
• to MPI, master	Yes
• to MPI, slave	Yes
• to DP, master	Yes; on DP slave only time-of-day slave
• to DP, slave	Yes
• in AS, master	Yes
• in AS, slave	Yes
<b>S7 message functions</b>	
Number of login stations for message functions, max.	32; Depending on the connections configured for PG/OP and S7 basic communication
Process diagnostic messages	
simultaneously active Alarm-S blocks, max.	60
<b>Test commissioning functions</b>	
Status/control	
• Status/control variable	Yes
• Variables	Inputs, outputs, memory bits, DB, times, counters
• Number of variables, max.	30
• of which status variables, max.	30
• of which control variables, max.	14
Forcing	
• Forcing	Yes
Status block	
• Status block	Yes
Single step	
• Single step	Yes
Number of breakpoints	
• Number of breakpoints	2
Diagnostic buffer	
• present	Yes
• Number of entries, max.	100
- can be set	No

# Fail-safe automation with SIMATIC

## CPUs for factory automation

### CPU 317F-2 DP

Order No.	6ES7 317-6FF03-0AB0
<b>Communication functions</b>	
PG/OP communication	Yes
Routing	Yes
Global data communication	
• supported	Yes
• Size of GD packets, max.	22 byte
S7 basic communication	
• supported	Yes
S7 communication	
• supported	Yes
S5-compatible communication	
• supported	Yes; via CP and loadable FC
Number of connections	
• overall	32
• usable for PG communication	31
• usable for OP communication	31
• usable for S7 basic communication	30
• usable for routing	8
<b>1st interface</b>	
Type of interface	Integrated RS 485 interface
Physics	RS 485
Isolated	Yes
Power supply to interface (15 to 30 V DC), max.	200 mA
Functionality	
• MPI	Yes
• DP master	Yes
• DP slave	Yes
• Point-to-point connection	No
MPI	
• Number of connections	32
• Services	
- PG/OP communication	Yes
- Routing	Yes
- Global data communication	Yes
- S7 basic communication	Yes
- S7 communication	Yes
- S7 communication, as client	No
- S7 communication, as server	Yes
• Transmission rate, max.	12 Mbit/s
DP master	
• Services	
- PG/OP communication	Yes
- Routing	Yes
- Global data communication	No
- S7 basic communication	Yes
- S7 communication	Yes
- S7 communication, as client	No
- S7 communication, as server	Yes
- Equidistance mode support	Yes
- Isochronous mode	No
- SYNC/FREEZE	Yes
- Activation/deactivation of DP slaves	Yes
- DPV1	Yes
• Transmission rate, max.	12 Mbit/s
• Number of DP slaves, max.	124
• Address area	
- Inputs, max.	244 byte
- Outputs, max.	244 byte

Order No.	6ES7 317-6FF03-0AB0
DP slave	
• Services	
- Routing	Yes; only with active interface
- Global data communication	No
- S7 basic communication	Yes
- S7 communication	Yes
- S7 communication, as client	No
- S7 communication, as server	Yes
- Direct data exchange (slave-to-slave communication)	Yes
- DPV1	No
• Transmission rate, max.	12 Mbit/s
• Transfer memory	
- Inputs	244 byte
- Outputs	244 byte
• Address area, max.	32
• User data per address area, max.	32 byte
<b>2nd interface</b>	
Type of interface	integrated RS 485 interface
Physics	RS 485
Isolated	Yes
Power supply to interface (15 to 30 V DC), max.	200 mA
Functionality	
• MPI	No
• DP master	Yes
• DP slave	Yes
• Local Operating Network	No
DP master	
• Number of connections, max.	32
• Services	
- PG/OP communication	Yes
- Routing	Yes
- Global data communication	No
- S7 basic communication	Yes
- S7 communication	Yes
- S7 communication, as client	No
- S7 communication, as server	Yes
- Equidistance mode support	Yes
- Isochronous mode	Yes; OB 61
- SYNC/FREEZE	Yes
- Activation/deactivation of DP slaves	Yes
- DPV1	Yes
• Transmission rate, max.	12 Mbit/s
• Number of DP slaves, max.	124
• Address area	
- Inputs, max.	244 byte
- Outputs, max.	244 byte
DP slave	
• Number of connections	32
• Services	
- PG/OP communication	Yes
- Routing	Yes; with interface active
- Global data communication	No
- S7 basic communication	Yes
- S7 communication, as client	No
- S7 communication, as server	Yes
- Direct data exchange (slave-to-slave communication)	Yes
- DPV1	No
• GSD file	The current GSD file can be obtained from: <a href="http://www.siemens.com/profibus-gsd">http://www.siemens.com/profibus-gsd</a>
• Transmission rate, max.	12 Mbit/s
• Automatic baud rate search	Yes; only with passive interface

# Fail-safe automation with SIMATIC

## CPUs for factory automation

CPU 317F-2 DP

Order No.	6ES7 317-6FF03-0AB0
• Transfer memory	
- Inputs	244 byte
- Outputs	244 byte
• Address area, max.	32
• User data per address area, max.	32 byte
<b>programming</b>	
Programming language	
• STEP 7	Yes; V5.2 SP1 or higher
• LAD	Yes
• FBD	Yes
• STL	Yes
• SCL	Yes
• CFC	Yes
• GRAPH	Yes
• HiGraph®	Yes
Command set	See instruction list
Nesting levels	8
Know-how protection	
• User program protection/password protection	Yes
System functions (SFC)	see instruction list
System function blocks (SFB)	see instruction list
<b>Dimensions and weight</b>	
Dimensions	
• Width	80 mm
• Height	125 mm
• Depth	130 mm
Weight	
• Weight, approx.	460 g

# Fail-safe automation with SIMATIC

## CPUs for factory automation

### CPU 317F-2 DP

#### Selection and ordering data

	Order No.
<b>CPU 317F-2 DP</b> Main memory 1024 KB, power supply 24 V DC, MPI/PROFIBUS DP master/slave interface, MMC required	<b>6ES7 317-6FF03-0AB0</b>
<b>SIPLUS CPU 317F-2 DP</b>	
• For constructing a fail-safe automation system. Suitable for exceptional medial exposure.	<b>6AG1 317-6FF03-2AB0</b>
• Same as above, but additionally suits standard for "Electronic equipment used on rolling stock" (EN 50155, temperature T1, category 1).	<b>6AG1 317-6FF03-2AY0</b>
<b>Distributed Safety V5.4 programming tool</b> Task: Software for configuring fail-safe user programs for SIMATIC S7-300F, S7-400F, ET 200S Requirement: STEP 7 V5.3 SP3 and higher	
Floating license	<b>6ES7 833-1FC02-0YA5</b>
Software Update Service	<b>6ES7 833-1FC00-0YX2</b>
<b>Distributed Safety Upgrade</b> From V5.x to V5.4; Floating license for 1 user	<b>6ES7 833-1FC02-0YE5</b>
<b>SIMATIC Micro Memory Card</b>	
64 KB	<b>6ES7 953-8LF20-0AA0</b>
128 KB	<b>6ES7 953-8LG20-0AA0</b>
512 KB	<b>6ES7 953-8LJ20-0AA0</b>
2 MB	<b>6ES7 953-8LL20-0AA0</b>
4 MB	<b>6ES7 953-8LM20-0AA0</b>
8 MB	<b>6ES7 953-8LP20-0AA0</b>
<b>MPI cable</b> for connection of SIMATIC S7 and PG via MPI; 5 m in length	<b>6ES7 901-0BF00-0AA0</b>
<b>Slot number plates</b>	<b>6ES7 912-0AA00-0AA0</b>
<b>S7-300 manual</b> Design, CPU data, module data, instruction list	
German	<b>6ES7 398-8FA10-8AA0</b>
English	<b>6ES7 398-8FA10-8BA0</b>
French	<b>6ES7 398-8FA10-8CA0</b>
Spanish	<b>6ES7 398-8FA10-8DA0</b>
Italian	<b>6ES7 398-8FA10-8EA0</b>
<b>SIMATIC Manual Collection</b> Electronic manuals on DVD, multi-lingual: LOGO!, SIMADYN, SIMATIC bus components, SIMATIC C7, SIMATIC distributed I/O, SIMATIC HMI, SIMATIC Sensors, SIMATIC NET, SIMATIC PC Based Automation, SIMATIC PCS 7, SIMATIC PG/PC, SIMATIC S7, SIMATIC Software, SIMATIC TDC	<b>6ES7 998-8XC01-8YE0</b>
<b>SIMATIC Manual Collection update service for 1 year</b> Current "Manual Collection" DVD and the three subsequent updates	<b>6ES7 998-8XC01-8YE2</b>

	Order No.
<b>Power supply connector</b> 10 units, spare part	<b>6ES7 391-1AA00-0AA0</b>
<b>Manual "Communication for SIMATIC S7-300/-400"</b>	
German	<b>6ES7 398-8EA00-8AA0</b>
English	<b>6ES7 398-8EA00-8BA0</b>
French	<b>6ES7 398-8EA00-8CA0</b>
Spanish	<b>6ES7 398-8EA00-8DA0</b>
Italian	<b>6ES7 398-8EA00-8EA0</b>
<b>PC adapter USB</b> for connecting a PC to SIMATIC S7-200/300/400 via USB; with USB cable (5 m)	<b>6ES7 972-0CB20-0XA0</b>
<b>PROFIBUS DP bus connector RS 485</b>	
• with 90° cable outlet, max. transfer rate 12 Mbit/s - without PG interface - with PG interface	<b>6ES7 972-0BA12-0XA0</b> <b>6ES7 972-0BB12-0XA0</b>
• with 90° cable outlet for FastConnect connection system, max. transfer rate 12 Mbit/s - without PG interface, 1 unit - without PG interface, 100 units - with PG interface, 1 unit - with PG interface, 100 units	<b>6ES7 972-0BA52-0XA0</b> <b>6ES7 972-0BA52-0XB0</b> <b>6ES7 972-0BB52-0XA0</b> <b>6ES7 972-0BB52-0XB0</b> <b>6GK1 500-0EA02</b>
• with axial cable outlet for SIMATIC OP, for connecting to PPI, MPI, PROFIBUS	
<b>PROFIBUS Fast Connect bus cable</b> Standard type with special design for quick mounting, 2-core, shielded, sold by the meter, max. delivery unit 1000 m, minimum ordering quantity 20 m	<b>6XV1 830-0EH10</b>
<b>RS 485 repeater for PROFIBUS</b> Transfer rate up to 12 Mbit/s; 24 V DC; IP20 enclosure	<b>6ES7 972-0AA01-0XA0</b>
<b>PROFIBUS bus components</b> for establishing MPI/PROFIBUS communication	<b>see Catalogs IK PI, CA 01</b>

# Fail-safe automation with SIMATIC CPUs for factory automation

CPU 315F-2 PN/DP

## Overview



- Based on CPU 315-2 PN/DP
- The CPU with medium-sized program memory and quantity structures for setting up a fail-safe automation system in plants with increased safety requirements
- Complies with safety requirements up to SIL 3 according to IEC 61508, PL e according to ISO 13849, and up to Cat. 4 according to EN 954-1
- Fail-safe I/O modules in distributed stations can be connected through the integrated PROFINET interface (PROFIsafe) and/or through the integrated PROFIBUS DP interface (PROFIsafe);
- Fail-safe I/O modules of the ET 200M range can also be centrally connected
- Central and distributed use of standard modules for non safety-relevant applications
- Component Based Automation (CBA) on PROFINET
- PROFINET IO Controller for operating distributed I/O on PROFINET
- PROFINET interface with 2-port switch
- PROFINET proxy for intelligent devices on PROFIBUS DP in Component Based Automation (CBA)

SIMATIC Micro Memory Card required for operation of CPU.

### SIPLUS Version

SIPLUS versions of this module are also available.

SIPLUS CPU 315F-2 PN/DP		
Order No.	<b>6AG1 315-2FJ14-2AB0</b>	<b>6AG1 315-2FJ14-2AY0</b>
Order No. based on	<b>6ES7 315-2FJ14-0AB0</b>	
Permitted ambient temperature	-25 ... +60 °C	
Permitted relative humidity	5 ... 100 %, condensation is allowed	
Suits standard for "Electronic equipment used on rolling stock" (EN 50155, temperature T1, category 1).	No	Yes
Conformal coating	Coating material of circuit boards and of electronic circuitry in accordance with EN 60721	
Technical data	The technical data are identical with those of the based-on module, except for the ambient conditions.	

Technical documentation for SIPLUS is available at:  
<http://www.siemens.com/siplus-extreme>

## Application

The CPU 315F-2 PN/DP allows a fail-safe automation system to be implemented for plants with increased safety requirements, especially in manufacturing automation.

It can be implemented as a PROFINET IO Controller and as a standard PROFIBUS DP Master in the SIMATIC S7-300. The CPU 315F-2 PN/DP can also be implemented as distributed intelligence (DP slave).

Distributed I/O stations containing fail-safe I/O modules can be connected via the two integrated interfaces. The fail-safe I/O modules of ET 200M can also be installed in central, safety-related configurations.

The safety-oriented communication between the F-CPU and the fail-safe I/O modules is performed on the basis of the PROFIsafe profile.

A SIMATIC Micro Memory Card is required for operation of the CPU.

## Design

The CPU 315F-2 PN/DP is equipped with the following:

- **Microprocessor:**  
The processor achieves an execution time of approximately 50 ns per binary instruction and 450 ns per floating-point operation.
- **Memory:**  
512 KB high-speed RAM for safety-relevant and standard program sections; increased memory space requirements must be expected (5 times larger) if safety-relevant program sections are implemented. SIMATIC Micro Memory Cards (max. 8 MB) as load memories for programs additionally permit storage of the project (including symbols and comments) in the CPU.
- **Flexible expansion capability:**  
Max. 32 modules, (4-tier configuration)
- **Combined MPI/DP interface:**  
The first MPI/DP integrated interface can establish as many as 16 connections simultaneously to S7-300/400 or connections to PG, PC, OP. Among these connections, one is always reserved for programming devices and another for OPs. A simple network with up to 32 CPUs can be configured with the MPI interfaces and "global data communication". The MPI interface can be reconfigured from an MPI to a DP interface. The DP interface can be used as a DP master or as a DP slave. PROFIBUS DP interface: The PROFIBUS DP V1 standard is fully supported. This increases the scope of DP V1 standard slaves in terms of diagnostics and parameterization capability.
- **Ethernet interface:**  
The second integral interface of the CPU 315-2 PN/DP is a PROFINET interface with 2-port switch based on Ethernet TCP/IP. It supports the following protocols:
  - S7 communication for data communication between SIMATIC controllers
  - PG/OP communication for programming, startup and diagnostics through STEP 7
  - PG/OP communication for interfacing to HMI and SCADA
  - Open TCP/IP communication over PROFINET and SIMATIC NET OPC server for communication with other controllers and I/O devices with a separate CPU

# Fail-safe automation with SIMATIC CPUs for factory automation

## CPU 315F-2 PN/DP

### Function

- Password protection; a password concept protects the user program from unauthorized access.
- Diagnostics buffer; the last 500 error and interrupt events are stored in a buffer for diagnostic purposes.
- Maintenance-free data backup; all data is automatically backed up by the CPU if the voltage is interrupted and is available unchanged after the voltage has been reconnected.

### Parameterizable properties

The S7 configuration as well as the properties and response of the CPUs can be parameterized using STEP 7:

- Multi-Point Interface (MPI); determination of node addresses.
- Start-up/cycle time behavior; definition of maximum cycle time and loading.
- Clock memory; setting of addresses.
- Protection level; definition of access rights for program and data.
- System diagnostics; definition of handling and scope of diagnostic messages.
- Watchdog interrupts; setting of periodicity.
- Time-of-day interrupts; setting of start date, start time, and periodicity.
- PROFIBUS DP master/slave interface; user-oriented address allocation for distributed I/O.

### Display and information functions

- Status and error indications; LEDs indicate hardware, programming, time, I/O or bus errors and operating statuses such as RUN, STOP, start-up.
- Test functions; the PG is used to indicate signal status during program execution, to modify process variables independently of the user program and to output the contents of stack memories.
- Information functions; the PG can be used to obtain information about the memory capacity and operating mode of the CPU, the current loading of the work and load memory, current cycle times and diagnostics buffer content in plain text.

### Integrated communication functions

- PG/OP communication
- Global data communication
- S7 basic communication
- S7 communication
- Open communication by means of TCP/IP
- PROFINET CBA
- Web server
- Data record routing

### Communication

Safety-oriented and standard communication between the central controller and distributed stations takes place over PROFIBUS DP and/or PROFINET. The specially developed PROFIsafe profile supports the transfer of user data for the safety functions within the standard data message frame. Additional hardware components, e.g. special safety buses are not required. The necessary software is either integrated in the hardware components as an expansion of the operating system or loaded into the CPU later as a certified software block.

### Mode of operation

The safety functions of the F-CPU are included in the F program of the CPU and in the fail-safe signal modules. The signal modules monitor the output and input signals by means of discrepancy analysis and the injection of test signals. The CPU checks the proper operation of the controller by means of periodic self-tests, command tests and logic-based and time-based program execution checks. Furthermore, the I/O is checked using requests for signs of life. If an error is diagnosed in the system, the system will be placed in a safe state. An F runtime license is not required to operate the CPU 319F-2 PN/DP.

### Programming

The CPU 315F-2 PN/DP is programmed in the same manner as the other SIMATIC S7 systems. The user program for non-fail-safe plant sections is created using familiar programming tools, e.g. STEP 7.

### SIMATIC S7 Distributed Safety option package

The STEP 7 option package "SIMATIC S7 Distributed Safety" is required for programming the safety-related program components. The package contains all the functions and blocks required to create an F program.

The F program with the safety functions is connected in F FBD or F LAD or using special function blocks from the F library. Use of F FBD or F LAD simplifies configuration and programming of the system and also acceptance testing thanks to the cross-system uniform presentation form. The programmer can concentrate on configuration of the safety-related application without the need to use additional tools.

### Technical specifications

Order No.	6ES7 315-2FJ14-0AB0
<b>Supply voltages</b>	
Rated value	
• permissible range, lower limit (DC)	20.4 V
external protection for supply cables (recommendation)	Min. 2 A
<b>Current consumption</b>	
Current consumption (rated value)	750 mA
Current consumption (in no-load operation), typ.	150 mA
Inrush current, typ.	4 A
$I^2t$	1 A <sup>2</sup> ·s
<b>Memory</b>	
Work memory	
• integrated	512 Kbyte
• expandable	No
• Size of retentive memory for retentive data blocks	128 Kbyte
Load memory	
• pluggable (MMC)	Yes
• pluggable (MMC), max.	8 Mbyte
Backup	
• present	Yes; guaranteed by MMC (maintenance-free)
• without battery	Yes; Program and data
<b>CPU-blocks</b>	
DB	
• Number, max.	1 024; Number range: 1 to 16000
• Size, max.	64 Kbyte



# Fail-safe automation with SIMATIC

## CPUs for factory automation

### CPU 315F-2 PN/DP

Order No.	6ES7 315-2FJ14-0AB0
FB	
• Number, max.	1 024; Number range: 0 to 7999
• Size, max.	64 Kbyte
FC	
• Number, max.	1 024; Number range: 0 to 7999
• Size, max.	64 Kbyte
OB	
• Size, max.	64 Kbyte
Nesting depth	
• per priority class	16
• additional within an error OB	4
<b>CPU processing times</b>	
for bit operations, min.	0.05 µs
for word operations, min.	0.09 µs
for fixed point arithmetic, min.	0.12 µs
for floating point arithmetic, min.	0.45 µs
<b>Counters, timers and their retentivity</b>	
S7 counter	
• Number	256
• Retentivity	
- can be set	Yes
- lower limit	0
- upper limit	255
• Counting range	
- can be set	Yes
- lower limit	0
- upper limit	999
IEC counter	
• present	Yes
• Type	SFB
S7 times	
• Number	256
• Retentivity	
- can be set	Yes
- lower limit	0
- upper limit	255
- preset	no retentivity
• Time range	
- lower limit	10 ms
- upper limit	9 990 s
IEC timer	
• present	Yes
• Type	SFB
<b>Data areas and their retentivity</b>	
Flag	
• Number, max.	2 048 byte
• Retentivity available	Yes; MB 0 to MB 2047
• Number of clock memories	8; 1 memory byte
Data blocks	
• Number, max.	1 024; Number range: 1 to 16000
• Size, max.	64 Kbyte
• Retentivity adjustable	Yes; via non-retain property on DB
• Retentivity preset	yes
Local data	
• per priority class, max.	32 Kbyte; max. 2 KB per block

Order No.	6ES7 315-2FJ14-0AB0
<b>Address area</b>	
I/O address area	
• overall	2 048 byte
• Outputs	2 048 byte
• of which, distributed	
- Inputs	2 048 byte
- Outputs	2 048 byte
Process image	
• Inputs	2 048 byte
• Outputs	2 048 byte
• Inputs, adjustable	2 048 byte
• Outputs, adjustable	2 048 byte
• Inputs, default	384 byte
• Outputs, default	384 byte
Subprocess images	
• No. of subprocess images	max. 1
Digital channels	
• Inputs	16 384
• Outputs	16 384
• Inputs, of which central	1 024
• Outputs, of which central	1 024
Analog channels	
• Inputs	1 024
• Outputs	1 024
• Inputs, of which central	256
• Outputs, of which central	256
<b>Hardware configuration</b>	
Central devices, max.	1
Expansion devices, max.	3
Racks, max.	4
Modules per rack, max.	8
Number of DP masters	
• integrated	1
• via CP	4
Number of operable FMs and CPs (recommended)	
• FM	8
• CP, point-to-point	8
• CP, LAN	10
<b>Time of day</b>	
Clock	
• Hardware clock (real-time clock)	Yes
• battery-backed and synchronizable	Yes
• Behavior of the clock following expiry of backup period	The clock continues at the time of day it had when power was switched off
• Deviation per day, max.	10 s; typ.: 2 s
Runtime meter	
• Number	1
• Number/Number range	0
• Range of values	0 to 2 <sup>31</sup> hours (when using SFC 101)
• Granularity	1 hour
• retentive	Yes; must be restarted at each restart
Clock synchronization	
• supported	Yes
• to MPI, master	Yes
• to MPI, slave	Yes
• to DP, master	Yes; on DP slave only time-of-day slave
• to DP, slave	Yes
• in AS, master	Yes
• in AS, slave	Yes
• on Ethernet via NTP	Yes; as client

# Fail-safe automation with SIMATIC

## CPUs for factory automation

### CPU 315F-2 PN/DP

Order No.	6ES7 315-2FJ14-0AB0
<b>S7 message functions</b>	
Number of login stations for message functions, max.	16; Depending on the connections configured for PG/OP and S7 basic communication
Process diagnostic messages	Yes
simultaneously active Alarm-S blocks, max.	300
<b>Test commissioning functions</b>	
Status/control	
• Status/control variable	Yes
• Variables	Inputs, outputs, memory bits, DB, times, counters
• Number of variables, max.	30
• of which status variables, max.	30
• of which control variables, max.	14
Forcing	
• Forcing	Yes
Status block	Yes; up to 2 simultaneously
Single step	Yes
Number of breakpoints	4
Diagnostic buffer	
• present	Yes
• Number of entries, max.	500
- can be set	No
- Of which powerfail-proof	100; only the last 100 entries are retained
<b>Monitoring functions</b>	
Status LEDs	Yes
<b>Communication functions</b>	
PG/OP communication	Yes
Data record routing	Yes
Routing	Yes
Global data communication	
• supported	Yes
• Size of GD packets, max.	22 byte
S7 basic communication	
• supported	Yes
S7 communication	
• supported	Yes
S5-compatible communication	
• supported	Yes; via CP and loadable FC
Web server	
• supported	Yes; Read-only function
Open IE communication	
• TCP/IP	Yes; via integrated PROFINET interface and loadable FBs
- Number of connections, max.	8
• ISO-on-TCP (RFC1006)	Yes; via integrated PROFINET interface and loadable FBs
- Number of connections, max.	8
- Data length, max.	32 768 byte
• UDP	Yes; via integrated PROFINET interface and loadable FBs
- Number of connections, max.	8
- Data length, max.	1 472 byte
Number of connections	
• overall	16
• usable for PG communication	15
• usable for OP communication	15
• usable for S7 basic communication	14

Order No.	6ES7 315-2FJ14-0AB0
• usable for S7 communication	14
- reserved for S7 communication	0
- Adjustable for S7 communication, min.	0
- Adjustable for S7 communication, max.	14
• Max. total number of instances	32
• usable for routing	X1 as MPI: max. 10; X1 as DP master: max. 24; X1 as DP slave (active): max. 14; X2 as PROFINET: max. 24
PROFINET CBA (at set setpoint communication load)	
• Setpoint for the CPU communication load	50 %
• Number of remote interconnection partners	32
• Number of functions, master/slave	30
• Total of all Master/Slave connections	1 000
• Data length of all incoming connections master/slave, max.	4 000 byte
• Data length of all outgoing connections master/slave, max.	4 000 byte
• Number of device-internal and PROFIBUS interconnections	500
• Data length of device-internal und PROFIBUS interconnections, max.	4 000 byte
• Data length per connection, max.	1 400 byte
• Remote interconnections with acyclic transmission	
- Sampling frequency: Sampling time, min.	500 ms
- Number of incoming interconnections	100
- Number of outgoing interconnections	100
- Data length of all incoming interconnections, max.	2 000 byte
- Data length of all outgoing interconnections, max.	2 000 byte
- Data length per connection, max.	1 400 byte
• Remote interconnections with cyclic transmission	
- Transmission frequency: Transmission interval, min.	10 ms
- Number of incoming interconnections	200
- Number of outgoing interconnections	200
- Data length of all incoming interconnections, max.	2 000 byte
- Data length of all outgoing interconnections, max.	2 000 byte
- Data length per connection, max.	450 byte
• HMI variables via PROFINET (acyclic)	
- Number of stations that can log on for HMI variables (PN OPC/iMap)	3; 2x PN OPC/1x iMap
- HMI variable updating	500 ms
- Number of HMI variables	200
- Data length of all HMI variables, max.	2 000 byte
• PROFIBUS proxy functionality	
- supported	Yes
- Number of linked PROFIBUS devices	16
- Data length per connection, max.	240 byte; slave-dependent

# Fail-safe automation with SIMATIC

## CPUs for factory automation

### CPU 315F-2 PN/DP

Order No.	6ES7 315-2FJ14-0AB0
<b>1st interface</b>	
Type of interface	Integrated RS 485 interface
Physics	RS 485
Isolated	Yes
Power supply to interface (15 to 30 V DC), max.	200 mA
Functionality	
• MPI	Yes
• DP master	Yes
• DP slave	Yes
• Point-to-point connection	No
MPI	
• Number of connections	16
• Services	
- PG/OP communication	Yes
- Routing	Yes
- Global data communication	Yes
- S7 basic communication	Yes
- S7 communication	Yes
- S7 communication, as client	No; but via CP and loadable FB
- S7 communication, as server	Yes
• Transmission rate, max.	12 Mbit/s
DP master	
• Services	
- PG/OP communication	Yes
- Routing	Yes
- Global data communication	No
- S7 basic communication	Yes; I blocks only
- S7 communication	Yes
- S7 communication, as client	No
- S7 communication, as server	Yes
- Equidistance mode support	Yes
- Isochronous mode	Yes; OB 61
- SYNC/FREEZE	Yes
- Activation/deactivation of DP slaves	Yes
- Number of DP slaves that can be simultaneously activated/deactivated, max.	8
- DPV1	Yes
• Transmission rate, max.	12 Mbit/s
• Number of DP slaves, max.	124
• Address area	
- Inputs, max.	2 Kbyte
- Outputs, max.	2 Kbyte
• User data per DP slave	
- Inputs, max.	244 byte
- Outputs, max.	244 byte
DP slave	
• Services	
- PG/OP communication	Yes
- Routing	Yes; only with active interface
- Global data communication	No
- S7 basic communication	No
- S7 communication	Yes
- S7 communication, as client	No
- S7 communication, as server	Yes; connection configured on one side only
- Direct data exchange (slave-to-slave communication)	Yes
- DPV1	No
• Transmission rate, max.	12 Mbit/s
• Transfer memory	
- Inputs	244 byte
- Outputs	244 byte
• Address area, max.	32
• User data per address area, max.	32 byte

Order No.	6ES7 315-2FJ14-0AB0
<b>2nd interface</b>	
Type of interface	PROFINET
Physics	Ethernet RJ45
Isolated	Yes
Integrated switch	Yes
Number of ports	2
automatic detection of transmission speed	Yes; 10/100 Mbit/s
Autonegotiation	Yes
Autocrossing	Yes
Functionality	
• MPI	No
• DP master	No
• DP slave	No
• PROFINET IO Controller	Yes
• PROFINET IO Device	Yes
• PROFINET CBA	Yes
• Web server	Yes
- Number of HTTP clients	5
• Local Operating Network	No
PROFINET IO Controller	
• Services	
- PG/OP communication	Yes
- Routing	Yes
- S7 communication	Yes; with loadable FBs, max. configurable connections: 14, max. number of instances: 32
- Isochronous mode	No
- Open IE communication	Yes; via TCP/IP, ISO on TCP and UDP
• Transmission rate, max.	100 Mbit/s
• Number of connectable IO devices, max.	128
• Max. number of connectable IO devices for RT	128
- of which in line, max.	128
• Number of IO Devices with IRT and the option "high flexibility"	128
- of which in line, max.	61
• IRT, supported	Yes
• Prioritized startup supported	Yes
- Number of IO Devices, max.	32
• Activation/deactivation of IO Devices	Yes
- Number of IO Devices that can be simultaneously activated/deactivated, max.	8
• IO Devices changing during operation (partner ports), supported	Yes
- Max. number of IO devices per tool	8
• Device replacement without swap medium	Yes
• Updating time	250 µs - 128 ms (with send cycle of 250 µs); 500 µs - 256 ms (with send cycle of 500 µs); 1 ms - 512 ms (with send cycle 1 ms); minimum value of the send cycle is also dependent on the set communication share for PROFINET IO, on the number of IO Devices
• Address area	
- Inputs, max.	2 Kbyte
- Outputs, max.	2 Kbyte
• User data per address area, max.	
- User data consistency, max.	254 byte

# Fail-safe automation with SIMATIC

## CPUs for factory automation

### CPU 315F-2 PN/DP

Order No.	6ES7 315-2FJ14-0AB0
PROFINET CBA	
• acyclic transmission	Yes
• cyclic transmission	Yes
Open IE communication	
• Open IE communication, supported	Yes
• Number of connections, max.	8
• Local port numbers used at the system end	0, 20, 21, 25, 80, 102, 135, 161, 8080, 34962, 34963, 34964, 65532, 65533, 65534, 65535
<b>programming</b>	
Programming language	
• STEP 7	Yes; V5.4 SP4 or higher with HW update
• LAD	Yes
• FBD	Yes
• STL	Yes
• SCL	Yes
• CFC	Yes
• GRAPH	Yes
• HiGraph®	Yes
Command set	See instruction list
Nesting levels	8
Know-how protection	
• User program protection/password protection	Yes
System functions (SFC)	See instruction list
System function blocks (SFB)	See instruction list
<b>Environmental requirements</b>	
Operating temperature	
• Min.	0 °C
<b>Dimensions</b>	
• Width	40 mm
• Height	125 mm
• Depth	130 mm

# Fail-safe automation with SIMATIC

## CPUs for factory automation

CPU 315F-2 PN/DP

### Selection and ordering data

	Order No.
<b>CPU 315F-2 PN/DP</b> CPU for SIMATIC S7-300F; 512 KB main memory, 24 V DC power supply, MPI/PROFIBUS DP master/slave interface, Industrial Ethernet/PROFINET interface; incl. slot number labels	<b>6ES7 315-2FJ14-0AB0</b>
<b>SIPLUS CPU 315F-2 PN/DP</b>	
<ul style="list-style-type: none"> <li>For constructing a fail-safe automation system. Suitable for exceptional medial exposure.</li> <li>Same as above, but additionally suits standard for "Electronic equipment used on rolling stock" (EN 50155, temperature T1, category 1).</li> </ul>	<b>6AG1 315-2FJ14-2AB0</b>  <b>6AG1 315-2FJ14-2AY0</b>
<b>Distributed Safety V5.4 programming tool</b> Task: Software for configuring fail-safe user programs for SIMATIC S7-300F, S7-400F, ET 200S Requirement: STEP 7 V5.3 SP3 and higher Floating license Software Update Service	<b>6ES7 833-1FC02-0YA5</b> <b>6ES7 833-1FC00-0YX2</b>
<b>Distributed Safety Upgrade</b> From V5.x to V5.4; Floating license for 1 user	<b>6ES7 833-1FC02-0YE5</b>
<b>SIMATIC Micro Memory Card</b>	
64 KB	<b>6ES7 953-8LF20-0AA0</b>
128 KB	<b>6ES7 953-8LG20-0AA0</b>
512 KB	<b>6ES7 953-8LJ20-0AA0</b>
2 MB	<b>6ES7 953-8LL20-0AA0</b>
4 MB	<b>6ES7 953-8LM20-0AA0</b>
8 MB	<b>6ES7 953-8LP20-0AA0</b>
<b>MPI cable</b>	<b>6ES7 901-0BF00-0AA0</b>
For connection of SIMATIC S7 and PG via MPI; 5 m in length	
<b>Slot number plates</b>	<b>6ES7 912-0AA00-0AA0</b>
<b>S7-300 manual</b>	
Design, CPU data, module data, instruction list	
German	<b>6ES7 398-8FA10-8AA0</b>
English	<b>6ES7 398-8FA10-8BA0</b>
French	<b>6ES7 398-8FA10-8CA0</b>
Spanish	<b>6ES7 398-8FA10-8DA0</b>
Italian	<b>6ES7 398-8FA10-8EA0</b>
<b>SIMATIC Manual Collection</b>	<b>6ES7 998-8XC01-8YE0</b>
Electronic manuals on DVD, multi-lingual: LOGO!, SIMADYN, SIMATIC bus components, SIMATIC C7, SIMATIC distributed I/O, SIMATIC HMI, SIMATIC Sensors, SIMATIC NET, SIMATIC PC Based Automation, SIMATIC PCS 7, SIMATIC PG/PC, SIMATIC S7, SIMATIC Software, SIMATIC TDC	

	Order No.
<b>SIMATIC Manual Collection update service for 1 year</b> Current "Manual Collection" DVD and the three subsequent updates	<b>6ES7 998-8XC01-8YE2</b>
<b>Power supply connector</b> 10 units, spare part	<b>6ES7 391-1AA00-0AA0</b>
<b>Manual "Communication for SIMATIC S7-300/-400"</b>	
German	<b>6ES7 398-8EA00-8AA0</b>
English	<b>6ES7 398-8EA00-8BA0</b>
French	<b>6ES7 398-8EA00-8CA0</b>
Spanish	<b>6ES7 398-8EA00-8DA0</b>
Italian	<b>6ES7 398-8EA00-8EA0</b>
<b>PC adapter USB</b> For connecting a PC to SIMATIC S7-200/300/400 via USB; with USB cable (5 m)	<b>6ES7 972-0CB20-0XA0</b>
<b>PROFIBUS DP bus connector RS 485</b>	
<ul style="list-style-type: none"> <li>With 90° cable outlet, max. transmission rate 12 Mbit/s <ul style="list-style-type: none"> <li>Without PG interface</li> <li>With PG interface</li> </ul> </li> <li>With 90° cable outlet for FastConnect connection system, max. transmission rate 12 Mbit/s <ul style="list-style-type: none"> <li>Without PG interface, 1 unit</li> <li>Without PG interface, 100 units</li> <li>With PG interface, 1 unit</li> <li>With PG interface, 100 units</li> </ul> </li> <li>With axial cable outlet for SIMATIC OP, for connecting to PPI, MPI, PROFIBUS</li> </ul>	<b>6ES7 972-0BA12-0XA0</b> <b>6ES7 972-0BB12-0XA0</b>  <b>6ES7 972-0BA52-0XA0</b> <b>6ES7 972-0BA52-0XB0</b> <b>6ES7 972-0BB52-0XA0</b> <b>6ES7 972-0BB52-0XB0</b> <b>6GK1 500-0EA02</b>
<b>PROFIBUS Fast Connect bus cable</b> Standard type with special design for quick mounting, 2-core, shielded, sold by the meter, max. delivery unit 1000 m, minimum ordering quantity 20 m	<b>6XV1 830-0EH10</b>
<b>RS 485 repeater for PROFIBUS</b> Transmission rate up to 12 Mbit/s; 24 V DC; IP20 enclosure	<b>6ES7 972-0AA01-0XA0</b>
<b>PROFINET bus components</b>	
<b>IE FC TP Standard Cable GP 2x2</b> 4-core, shielded TP installation cable for connection to IE FC Outlet RJ45/ IE FC RJ45 Plug; PROFINET-compatible; with UL approval; sold by the meter	<b>6XV1 840-2AH10</b>
<b>FO Standard Cable GP (50/125)</b> Standard cable, splittable, UL approval, sold by the meter	<b>6XV1 873-2A</b>

3

# Fail-safe automation with SIMATIC

## CPUs for factory automation

### CPU 315F-2 PN/DP

	Order No.
<b>SCALANCE X204-2 Industrial Ethernet Switch</b> Industrial Ethernet Switches with integral SNMP access, Web diagnostics, copper cable diagnostics and PROFINET diagnostics for configuring line, star and ring topologies; four 10/100 Mbit/s RJ45 ports and two FO ports	<b>6GK5 204-2BB10-2AA3</b>
<b>CSM 377 Compact Switch Module</b> Unmanaged switch for connecting a SIMATIC S7-300, ET200 M and up to three other participants to Industrial Ethernet with 10/100 Mbit/s; 4 x RJ45 ports; external 24 V DC power supply, LED diagnostics, S7-300 module incl. electronic manual on CD-ROM	<b>6GK7 377-1AA00-0AA0</b>
<b>IE FC RJ45 Plugs</b> RJ45 plug connector for Industrial Ethernet with a rugged metal enclosure and integrated insulation displacement contacts for connecting Industrial Ethernet FC installation cables	
<b>IE FC RJ45 Plug 145</b> 145° cable outlet 1 unit 10 units 50 units	<b>6GK1 901-1BB30-0AA0</b> <b>6GK1 901-1BB30-0AB0</b> <b>6GK1 901-1BB30-0AE0</b>
<b>IE FC RJ45 Plug 180</b> 180° cable outlet 1 unit 10 units 50 units	<b>6GK1 901-1BB10-2AA0</b> <b>6GK1 901-1BB10-2AB0</b> <b>6GK1 901-1BB10-2AE0</b>
<b>PROFIBUS/PROFINET bus components</b> For establishing MPI/PROFIBUS/PROFINET communication	<b>See Catalog IK PI, CA 01</b>

3

# Fail-safe automation with SIMATIC CPUs for factory automation

CPU 317F-2 PN/DP

## Overview



- Based on CPU 317-2 PN/DP
- The fail-safe CPU with a large program memory and quantity framework for demanding applications; for setting up a fail-safe automation system in plants with increased safety requirements.
- Complies with safety requirements up to SIL 3 according to IEC 61508, PL e according to ISO 13849-1, and up to Cat. 4 according to EN 954-1
- Fail-safe I/O modules in distributed stations can be connected through the integrated PROFINET interface (PROFIsafe) and/or through the integrated PROFIBUS DP interface (PROFIsafe)
- Fail-safe I/O modules of the ET 200M range can also be centrally connected
- Central and distributed use of standard modules for non safety-relevant applications
- Component Based Automation (CBA) on PROFINET
- PROFINET IO Controller for operating distributed I/O on PROFINET
- PROFINET interface with 2-port switch
- PROFINET proxy for intelligent devices on PROFIBUS DP in Component Based Automation (CBA)

SIMATIC Micro Memory Card required for operation of CPU.

### SIPLUS Version

SIPLUS versions of this module are also available.

SIPLUS CPU 317F-2 PN/DP		
Order No.	<b>6AG1 317-2FK14-2AB0</b>	<b>6AG1 317-2FK14-2AY0</b>
Order No. based on	<b>6ES7 317-2FK14-0AB0</b>	
Permitted ambient temperature	-25 ... +60 °C	
Permitted relative humidity	5 ... 100 %, condensation is allowed	
Suits standard for "Electronic equipment used on rolling stock" (EN 50155, temperature T1, category 1).	No	Yes
Conformal coating	Coating material of circuit boards and of electronic circuitry in accordance with EN 60721	
Technical data	The technical data are identical with those of the based-on module, except for the ambient conditions.	

Technical documentation for SIPLUS is available at:

<http://www.siemens.com/siplus-extreme>

## Application

The CPU 317F-2 PN/DP allows a more complex fail-safe automation system to be implemented for plants with increased safety requirements, especially in manufacturing automation.

It can be implemented as a PROFINET IO Controller and as a standard PROFIBUS DP Master in the SIMATIC S7-300. The CPU 317F-2 PN/DP can also be implemented as distributed intelligence (DP slave).

Distributed I/O stations containing fail-safe I/O modules can be connected via the two integrated interfaces. The fail-safe I/O modules of ET 200M can also be installed in central, safety-related configurations.

The safety-oriented communication between the F-CPU and the fail-safe I/O modules is performed on the basis of the PROFIsafe profile.

A SIMATIC Micro Memory Card is required for operation of the CPU.

## Design

The CPU 317F-2 PN/DP is equipped with the following:

- **Microprocessor:**  
The processor achieves an execution time of approximately 25 ns per binary instruction and 160 ns per floating-point operation.
- **Memory:** 1.5 MB high-speed main memory for safety-relevant and standard program sections; increased memory space requirements must be expected (5 times larger) if safety-relevant program sections are implemented. SIMATIC Micro Memory Cards (max. 8 MB) as load memories for programs additionally permit storage of the project (including symbols and comments) in the CPU.
- **Flexible expansion capability:**  
Max. 32 modules, (4-tier configuration)
- **Combined MPI/DP interface:**  
The first MPI/DP integrated interface can establish as many as 16 connections simultaneously to S7-300/400 or connections to PG, PC, OP. Of the connections, one is permanently reserved for programming devices and one for OPs. The MPI supports simple networking of up to 32 CPUs over "Global data communication". This interface can be reconfigured from MPI interface to DP interface. The DP interface can be used as a DP master or as a DP slave. PROFIBUS DP interface: The PROFIBUS DP V1 standard is fully supported. This increases the scope of DP V1 standard slaves in terms of diagnostics and parameterization capability.
- **Ethernet interface:**  
The second integral interface of the CPU 317F-2 PN/DP is a PROFINET interface with 2-port switch based on Ethernet TCP/IP. It supports the following protocols:
  - S7 communication for data communication between SIMATIC controllers;
  - PG/OP communication for programming, startup and diagnostics through STEP 7;
  - PG/OP communication for interfacing to HMI and SCADA;
  - Open TCP/IP communication over PROFINET and SIMATIC NET OPC server for communication with other controllers and I/O devices with a separate CPU.

# Fail-safe automation with SIMATIC

## CPUs for factory automation

### CPU 317F-2 PN/DP

#### Function

- Password protection; a password concept protects the user program from unauthorized access.
- Diagnostics buffer; the last 500 error and interrupt events are stored in a buffer for diagnostic purposes.
- Maintenance-free data backup; all data is automatically backed up by the CPU if the voltage is interrupted and is available unchanged after the voltage has been reconnected.

#### Parameterizable properties

The S7 configuration as well as the properties and response of the CPUs can be parameterized using STEP 7:

- Multi-Point Interface (MPI); determination of node addresses.
- Start-up/cycle time behavior; definition of maximum cycle time and loading.
- Clock memory; setting of addresses.
- Protection level; definition of access rights for program and data.
- System diagnostics; definition of handling and scope of diagnostic messages.
- Watchdog interrupts; setting of periodicity.
- Time-of-day interrupts; setting of start date, start time, and periodicity.
- PROFIBUS DP master/slave interface; user-oriented address allocation for distributed I/O.

#### Display and information functions

- Status and error indications; LEDs indicate hardware, programming, time, I/O or bus errors and operating statuses such as RUN, STOP, start-up.
- Test functions; the PG is used to indicate signal status during program execution, to modify process variables independently of the user program and to output the contents of stack memories.
- Information functions; the PG can be used to obtain information about the memory capacity and operating mode of the CPU, the current loading of the work and load memory, current cycle times and diagnostics buffer content in plain text.

#### Integrated communication functions

- PG/OP communication
- Global data communication
- S7 basic communication
- S7 communication
- Open communication by means of TCP/IP
- PROFINET CBA
- Web server
- Data record routing

#### **Communication**

Safety-oriented and standard communication between the central controller and distributed stations takes place over PROFIBUS DP and/or PROFINET. The specially developed PROFIsafe profile supports the transfer of user data for the safety functions within the standard data message frame. Additional hardware components, e.g. special safety buses are not required. The necessary software is either integrated in the hardware components as an expansion of the operating system or loaded into the CPU later as a certified software block.

#### **Mode of operation**

The safety functions of the F-CPU are included in the F program of the CPU and in the fail-safe signal modules. The signal modules monitor the output and input signals by means of discrepancy analysis and the injection of test signals.

The CPU checks the proper operation of the controller by means of periodic self-tests, command tests and logic-based and time-based program execution checks. Furthermore, the I/O is checked using requests for signs of life.

If an error is diagnosed in the system, the system will be placed in a safe state.

An F runtime license is not required to operate the CPU 317F-2 PN/DP.

#### **Programming**

The CPU 317F-2 PN/DP is programmed in the same manner as the other SIMATIC S7 systems. The user program for non-fail-safe plant units is created using tried and tested programming tools, e.g. STEP 7.

#### SIMATIC S7 Distributed Safety option package

The STEP 7 option package "SIMATIC S7 Distributed Safety" is required for programming the safety-related program components. The package contains all the functions and blocks required to create an F program.

The F program with the safety functions is connected in F FBD or F LAD or using special function blocks from the F library. Use of F FBD or F LAD simplifies configuration and programming of the system and also acceptance testing thanks to the cross-system uniform presentation form. The programmer can concentrate on configuration of the safety-related application without the need to use additional tools.



### Technical specifications

Order No.	6ES7 317-2FK14-0AB0
<b>Product version</b>	
associated programming package	STEP 7 > V 5.4 + SP5 or STEP 7 V5.4 + SP4 or higher with HSP 189, S7 Distributed Safety V5.4 or higher
<b>Supply voltages</b>	
Rated value	
• permissible range, lower limit (DC)	20.4 V
External protection for supply cables (recommendation)	Min. 2 A
<b>Current consumption</b>	
Current consumption (rated value)	750 mA
Current consumption (in no-load operation), typ.	150 mA
Inrush current, typ.	4 A
$I^2t$	1 A <sup>2</sup> ·s
<b>Memory</b>	
Work memory	
• integrated	1.5 Mbyte
• expandable	No
• Size of retentive memory for retentive data blocks	256 Kbyte
Load memory	
• pluggable (MMC)	Yes
• pluggable (MMC), max.	8 Mbyte
Backup	
• present	Yes; guaranteed by MMC (maintenance-free)
• without battery	Yes; Program and data
<b>CPU-blocks</b>	
DB	
• Number, max.	2 048; Number range: 1 to 16000
• Size, max.	64 Kbyte
FB	
• Number, max.	2 048; Number range: 0 to 7999
• Size, max.	64 Kbyte
FC	
• Number, max.	2 048; Number range: 0 to 7999
• Size, max.	64 Kbyte
OB	
• Size, max.	64 Kbyte
Nesting depth	
• per priority class	16
• additional within an error OB	4
<b>CPU processing times</b>	
for bit operations, min.	0.025 µs
for word operations, min.	0.03 µs
for fixed point arithmetic, min.	0.04 µs
for floating point arithmetic, min.	0.16 µs

Order No.	6ES7 317-2FK14-0AB0
<b>Counters, timers and their retentivity</b>	
S7 counter	
• Number	512
• Retentivity	
- can be set	Yes
- lower limit	0
- upper limit	511
• Counting range	
- can be set	Yes
- lower limit	0
- upper limit	999
IEC counter	
• present	Yes
• Type	SFB
S7 times	
• Number	512
• Retentivity	
- can be set	Yes
- lower limit	0
- upper limit	511
- preset	no retentivity
• Time range	
- lower limit	10 ms
- upper limit	9 990 s
IEC timer	
• present	Yes
• Type	SFB
<b>Data areas and their retentivity</b>	
Flag	
• Number, max.	4 096 byte
• Retentivity available	Yes; MB 0 to MB 4095
• Number of clock memories	8; 1 memory byte
Data blocks	
• Number, max.	2 048; Number range: 1 to 16000
• Size, max.	64 Kbyte
• Retentivity adjustable	Yes; via non-retain property on DB
• Retentivity preset	yes
Local data	
• per priority class, max.	32 Kbyte; max. 2 KB per block
<b>Address area</b>	
I/O address area	
• overall	8 192 byte
• Outputs	8 192 byte
• of which, distributed	
- Inputs	8 192 byte
- Outputs	8 192 byte
Process image	
• Inputs	8 192 byte
• Outputs	8 192 byte
• Inputs, adjustable	8 192 byte
• Outputs, adjustable	8 192 byte
• Inputs, default	1 024 byte
• Outputs, default	1 024 byte
Subprocess images	
• Number of subprocess images, max.	1
Digital channels	
• Inputs	65 536
• Outputs	65 536
• Inputs, of which central	1 024
• Outputs, of which central	1 024

# Fail-safe automation with SIMATIC

## CPUs for factory automation

### CPU 317F-2 PN/DP

Order No.	6ES7 317-2FK14-0AB0
Analog channels	
• Inputs	4 096
• Outputs	4 096
• Inputs, of which central	256
• Outputs, of which central	256
<b>Hardware configuration</b>	
Central devices, max.	1
Expansion devices, max.	3
Racks, max.	4
Modules per rack, max.	8
Number of DP masters	
• integrated	1
• via CP	4
Number of operable FMs and CPs (recommended)	
• FM	8
• CP, point-to-point	8
• CP, LAN	10
<b>Time of day</b>	
Clock	
• Hardware clock (real-time clock)	Yes
• battery-backed and synchronizable	Yes
• Behavior of the clock following expiry of backup period	The clock continues at the time of day it had when power was switched off
• Deviation per day, max.	10 s; typ.: 2 s
Runtime meter	
• Number	4
• Number/Number range	0 to 3
• Range of values	0 to 2 <sup>31</sup> hours (when using SFC 101)
• Granularity	1 hour
• retentive	Yes; must be restarted at each restart
Clock synchronization	
• supported	Yes
• to MPI, master	Yes
• to MPI, slave	Yes
• to DP, master	Yes; on DP slave only time-of-day slave
• to DP, slave	Yes
• in AS, master	Yes
• in AS, slave	Yes
• on Ethernet via NTP	Yes; as client
<b>S7 message functions</b>	
Number of login stations for message functions, max.	32; Depending on the connections configured for PG/OP and S7 basic communication
Process diagnostic messages	Yes
simultaneously active Alarm-S blocks, max.	300
<b>Test commissioning functions</b>	
Status/control	
• Status/control variable	Yes
• Variables	Inputs, outputs, memory bits, DB, times, counters
• Number of variables, max.	30
• of which status variables, max.	30
• of which control variables, max.	14
Forcing	
• Forcing	Yes
Status block	Yes; up to 2 simultaneously
Single step	Yes

Order No.	6ES7 317-2FK14-0AB0
Number of breakpoints	4
Diagnostic buffer	
• present	Yes
• Number of entries, max.	500
- can be set	No
- Of which powerfail-proof	100; only the last 100 entries are retained
• Number of entries readable in RUN, max.	499
- adjustable	Yes; From 10 to 499
- preset	10
Service data	
• can be read out	Yes
<b>Monitoring functions</b>	
Status LEDs	Yes
<b>Communication functions</b>	
PG/OP communication	Yes
Data record routing	Yes
Routing	Yes
Global data communication	
• supported	Yes
• Size of GD packets, max.	22 byte
S7 basic communication	
• supported	Yes
S7 communication	
• supported	Yes
S5-compatible communication	
• supported	Yes; via CP and loadable FC
Web server	
• supported	Yes; Read-only function
• Number of HTTP clients	5
Open IE communication	
• TCP/IP	Yes; via integrated PROFINET interface and loadable FBs
- Number of connections, max.	16
• ISO-on-TCP (RFC1006)	Yes; via integrated PROFINET interface and loadable FBs
- Number of connections, max.	16
- Data length, max.	32 768 byte
• UDP	Yes; via integrated PROFINET interface and loadable FBs
- Number of connections, max.	16
- Data length, max.	1 472 byte
Number of connections	
• overall	32
• usable for PG communication	31
• usable for OP communication	31
• usable for S7 basic communication	30
• usable for S7 communication	16
- reserved for S7 communication	0
- Adjustable for S7 communication, min.	0
- Adjustable for S7 communication, max.	16
• Max. total number of instances	32
• usable for routing	X1 as MPI: max. 10; X1 as DP master: max. 24; X1 as DP slave (active): max. 14; X2 as PROFINET: max. 24
PROFINET CBA (at set setpoint communication load)	
• Setpoint for the CPU communication load	50 %
• Number of remote interconnection partners	32

# Fail-safe automation with SIMATIC

## CPUs for factory automation

### CPU 317F-2 PN/DP

Order No.	6ES7 317-2FK14-0AB0
• Number of functions, master/slave	30
• Total of all Master/Slave connections	1 000
• Data length of all incoming connections master/slave, max.	4 000 byte
• Data length of all outgoing connections master/slave, max.	4 000 byte
• Number of device-internal and PROFIBUS interconnections	500
• Data length of device-internal und PROFIBUS interconnections, max.	4 000 byte
• Data length per connection, max.	1 400 byte
• Remote interconnections with acyclic transmission	
- Sampling frequency: Sampling time, min.	500 ms
- Number of incoming interconnections	100
- Number of outgoing interconnections	100
- Data length of all incoming interconnections, max.	2 000 byte
- Data length of all outgoing interconnections, max.	2 000 byte
- Data length per connection, max.	1 400 byte
• Remote interconnections with cyclic transmission	
- Transmission frequency: Transmission interval, min.	10 ms
- Number of incoming interconnections	200
- Number of outgoing interconnections	200
- Data length of all incoming interconnections, max.	2 000 byte
- Data length of all outgoing interconnections, max.	2 000 byte
- Data length per connection, max.	450 byte
• HMI variables via PROFINET (acyclic)	
- Number of stations that can log on for HMI variables (PN OPC/iMap)	3; 2x PN OPC/1x iMap
- HMI variable updating	500 ms
- Number of HMI variables	200
- Data length of all HMI variables, max.	2 000 byte
• PROFIBUS proxy functionality	
- supported	Yes
- Number of linked PROFIBUS devices	16
- Data length per connection, max.	240 byte; slave-dependent
<b>1st interface</b>	
Type of interface	Integrated RS 485 interface
Physics	RS 485
Isolated	Yes
Power supply to interface (15 to 30 V DC), max.	200 mA
Functionality	
• MPI	Yes
• DP master	Yes
• DP slave	Yes
• Point-to-point connection	No

Order No.	6ES7 317-2FK14-0AB0
MPI	
• Number of connections	32
• Services	
- PG/OP communication	Yes
- Routing	Yes
- Global data communication	Yes
- S7 basic communication	Yes
- S7 communication	Yes
- S7 communication, as client	No; but via CP and loadable FB
- S7 communication, as server	Yes
• Transmission rate, max.	12 Mbit/s
DP master	
• Services	
- PG/OP communication	Yes
- Routing	Yes
- Global data communication	No
- S7 basic communication	Yes; I blocks only
- S7 communication	Yes
- S7 communication, as client	No
- S7 communication, as server	Yes
- Equidistance mode support	Yes
- Isochronous mode	Yes; OB 61
- SYNC/FREEZE	Yes
- Activation/deactivation of DP slaves	Yes
- Number of DP slaves that can be simultaneously activated/deactivated, max.	8
- DPV1	Yes
• Transmission rate, max.	12 Mbit/s
• Number of DP slaves, max.	124
• Address area	
- Inputs, max.	8 Kbyte
- Outputs, max.	8 Kbyte
• User data per DP slave	
- Inputs, max.	244 byte
- Outputs, max.	244 byte
DP slave	
• Services	
- PG/OP communication	Yes
- Routing	Yes; only with active interface
- Global data communication	No
- S7 basic communication	No
- S7 communication	Yes
- S7 communication, as client	No
- S7 communication, as server	Yes; connection configured on one side only
- Direct data exchange (slave-to-slave communication)	Yes
- DPV1	No
• Transmission rate, max.	12 Mbit/s
• Transfer memory	
- Inputs	244 byte
- Outputs	244 byte
• Address area, max.	32
• User data per address area, max.	32 byte
<b>2nd interface</b>	
Type of interface	PROFINET
Physics	Ethernet RJ45
Isolated	Yes
Integrated switch	Yes
Number of ports	2
automatic detection of transmission speed	Yes; 10/100 Mbit/s
Autonegotiation	Yes
Autocrossing	Yes

# Fail-safe automation with SIMATIC

## CPUs for factory automation

### CPU 317F-2 PN/DP

Order No.	6ES7 317-2FK14-0AB0
Functionality	
• MPI	No
• DP master	No
• DP slave	No
• PROFINET IO Controller	Yes
• PROFINET IO Device	Yes
• PROFINET CBA	Yes
• Web server	Yes
- Number of HTTP clients	5
• Local Operating Network	No
PROFINET IO Controller	
• Services	
- PG/OP communication	Yes
- Routing	Yes
- S7 communication	Yes; with loadable FBs, max. configurable connections: 16, max. number of instances: 32
- Isochronous mode	No
- Open IE communication	Yes; via TCP/IP, ISO on TCP and UDP
• Transmission rate, max.	100 Mbit/s
• Number of connectable IO devices, max.	128
• Max. number of connectable IO devices for RT	128
- of which in line, max.	128
• Number of IO Devices with IRT and the option "high flexibility"	128
- of which in line, max.	61
• IRT, supported	Yes
• Prioritized startup supported	Yes
- Number of IO Devices, max.	32
• Activation/deactivation of IO Devices	Yes
- Number of IO Devices that can be simultaneously activated/deactivated, max.	8
• IO Devices changing during operation (partner ports), supported	Yes
- Max. number of IO devices per tool	8
• Device replacement without swap medium	Yes
• Updating time	250 µs - 128 ms (with send cycle of 250 µs); 500 µs - 256 ms (with send cycle of 500 µs); 1 ms - 512 ms (with send cycle 1 ms); minimum value of the send cycle is also dependent on the set communication share for PROFINET IO, on the number of IO Devices
• Address area	
- Inputs, max.	8 Kbyte
- Outputs, max.	8 Kbyte
• User data per address area, max.	
- User data consistency, max.	254 byte
PROFINET CBA	
• acyclic transmission	Yes
• cyclic transmission	Yes
Open IE communication	
• Open IE communication, supported	Yes
• Number of connections, max.	8
• Local port numbers used at the system end	0, 20, 21, 25, 80, 102, 135, 161, 8080, 34962, 34963, 34964, 65532, 65533, 65534, 65535

Order No.	6ES7 317-2FK14-0AB0
<b>Programming</b>	
Programming language	
• STEP 7	Yes; V5.4 SP4 or higher with HW update
• LAD	Yes
• FBD	Yes
• STL	Yes
• SCL	Yes
• CFC	Yes
• GRAPH	Yes
• HiGraph®	Yes
Command set	See instruction list
Nesting levels	8
Know-how protection	
• User program protection/password protection	Yes
System functions (SFC)	See instruction list
System function blocks (SFB)	See instruction list
<b>Environmental requirements</b>	
Operating temperature	
• Min.	0 °C
<b>Dimensions and weight</b>	
Dimensions	
• Width	40 mm
• Height	125 mm
• Depth	130 mm
Weight	
• Weight, approx.	340 g

# Fail-safe automation with SIMATIC

## CPUs for factory automation

CPU 317F-2 PN/DP

### Selection and ordering Data

	Order No.
<b>CPU 317F-2 PN/DP</b>	<b>6ES7 317-2FK14-0AB0</b>
Main memory 1.5 MB, power supply 24 V DC, MPI/PROFIBUS DP master/slave interface; Industrial Ethernet/PROFINET interface; MMC required	
<b>SIPLUS CPU 317F-2 PN/DP</b>	
<ul style="list-style-type: none"> <li>For constructing a fail-safe automation system. Suitable for exceptional medial exposure.</li> <li>Same as above, but additionally suits standard for "Electronic equipment used on rolling stock" (EN 50155, temperature T1, category 1).</li> </ul>	<b>6AG1 317-2FK14-2AB0</b>  <b>6AG1 317-2FK14-2AY0</b>
<b>Distributed Safety V5.4 programming tool</b>	
Task: Software for configuring fail-safe user programs for SIMATIC S7-300F, S7-400F, ET 200S Requirement: STEP 7 V5.3 SP3 and higher	
Floating license	<b>6ES7 833-1FC02-0YA5</b>
Software Update Service	<b>6ES7 833-1FC00-0YX2</b>
<b>Distributed Safety Upgrade</b>	
From V5.x to V5.4; Floating license for 1 user	<b>6ES7 833-1FC02-0YE5</b>
<b>SIMATIC Micro Memory Card</b>	
64 KB	<b>6ES7 953-8LF20-0AA0</b>
128 KB	<b>6ES7 953-8LG20-0AA0</b>
512 KB	<b>6ES7 953-8LJ20-0AA0</b>
2 MB	<b>6ES7 953-8LL20-0AA0</b>
4 MB	<b>6ES7 953-8LM20-0AA0</b>
8 MB	<b>6ES7 953-8LP20-0AA0</b>
<b>MPI cable</b>	<b>6ES7 901-0BF00-0AA0</b>
for connection of SIMATIC S7 and PG via MPI; 5 m in length	
<b>Slot number plates</b>	<b>6ES7 912-0AA00-0AA0</b>
<b>S7-300 manual</b>	
Design, CPU data, module data, instruction list	
German	<b>6ES7 398-8FA10-8AA0</b>
English	<b>6ES7 398-8FA10-8BA0</b>
French	<b>6ES7 398-8FA10-8CA0</b>
Spanish	<b>6ES7 398-8FA10-8DA0</b>
Italian	<b>6ES7 398-8FA10-8EA0</b>
<b>SIMATIC Manual Collection</b>	<b>6ES7 998-8XC01-8YE0</b>
Electronic manuals on DVD, multi-lingual: LOGO!, SIMADYN, SIMATIC bus components, SIMATIC C7, SIMATIC distributed I/O, SIMATIC HMI, SIMATIC Sensors, SIMATIC NET, SIMATIC PC Based Automation, SIMATIC PCS 7, SIMATIC PG/PC, SIMATIC S7, SIMATIC Software, SIMATIC TDC	
<b>SIMATIC Manual Collection update service for 1 year</b>	<b>6ES7 998-8XC01-8YE2</b>
Current "Manual Collection" DVD and the three subsequent updates	

	Order No.
<b>Power supply connector</b>	<b>6ES7 391-1AA00-0AA0</b>
10 units, spare part	
<b>Manual "Communication for SIMATIC S7-300/-400"</b>	
German	<b>6ES7 398-8EA00-8AA0</b>
English	<b>6ES7 398-8EA00-8BA0</b>
French	<b>6ES7 398-8EA00-8CA0</b>
Spanish	<b>6ES7 398-8EA00-8DA0</b>
Italian	<b>6ES7 398-8EA00-8EA0</b>
<b>PC adapter USB</b>	<b>6ES7 972-0CB20-0XA0</b>
for connecting a PC to SIMATIC S7-200/300/400 via USB; with USB cable (5 m)	
<b>PROFIBUS DP bus connector RS 485</b>	
<ul style="list-style-type: none"> <li>with 90° cable outlet, max. transfer rate 12 Mbit/s <ul style="list-style-type: none"> <li>without PG interface</li> <li>with PG interface</li> </ul> </li> <li>with 90° cable outlet for FastConnect connection system, max. transfer rate 12 Mbit/s <ul style="list-style-type: none"> <li>without PG interface, 1 unit</li> <li>without PG interface, 100 units</li> <li>with PG interface, 1 unit</li> <li>with PG interface, 100 units</li> </ul> </li> <li>with axial cable outlet for SIMATIC OP, for connecting to PPI, MPI, PROFIBUS</li> </ul>	<b>6ES7 972-0BA12-0XA0</b> <b>6ES7 972-0BB12-0XA0</b>  <b>6ES7 972-0BA52-0XA0</b> <b>6ES7 972-0BA52-0XB0</b> <b>6ES7 972-0BB52-0XA0</b> <b>6ES7 972-0BB52-0XB0</b> <b>6GK1 500-0EA02</b>
<b>PROFIBUS Fast Connect bus cable</b>	<b>6XV1 830-0EH10</b>
Standard type with special design for quick mounting, 2-core, shielded, sold by the meter, max. delivery unit 1000 m, minimum ordering quantity 20 m	
<b>RS 485 repeater for PROFIBUS</b>	<b>6ES7 972-0AA01-0XA0</b>
Transfer rate up to 12 Mbit/s; 24 V DC; IP20 enclosure	
<b>PROFINET bus components</b>	
<b>IE FC TP standard cable GP 2x2</b>	<b>6XV1 840-2AH10</b>
4-core, shielded TP installation cable for connection to IE FC Outlet RJ45/ IE FC RJ45 Plug; PROFINET-compatible; with UL approval;	
Sold by the meter	
<b>FO Standard Cable GP (50/125)</b>	<b>6XV1 873-2A</b>
Standard cable, splittable, UL approval, sold by the meter	
<b>SCALANCE X204-2 Industrial Ethernet Switch</b>	<b>6GK5 204-2BB10-2AA3</b>
Industrial Ethernet Switches with integral SNMP access, Web diagnostics, copper cable diagnostics and PROFINET diagnostics for configuring line, star and ring topologies; four 10/100 Mbit/s RJ45 ports and two FO ports	

# Fail-safe automation with SIMATIC

## CPUs for factory automation

### CPU 317F-2 PN/DP

	Order No.
<b>Compact Switch Module CSM 377</b> Unmanaged switch for connecting a SIMATIC S7-300, ET200 M and up to three other participants to Industrial Ethernet with 10/100 Mbit/s; 4 x RJ45 ports; external 24 V DC power supply, LED diagnostics, S7-300 module incl. electronic manual on CD-ROM	<b>6GK7 377-1AA00-0AA0</b>
<b>IE FC RJ45 plugs</b> RJ45 plug connector for Industrial Ethernet with a rugged metal enclosure and integrated insulation displacement contacts for connecting Industrial Ethernet FC installation cables	
<b>IE FC RJ45 plug 145</b> 145° cable outlet 1 unit 10 units 50 units	<b>6GK1 901-1BB30-0AA0</b> <b>6GK1 901-1BB30-0AB0</b> <b>6GK1 901-1BB30-0AE0</b>
<b>IE FC RJ45 plug 180</b> 180° cable outlet 1 unit 10 units 50 units	<b>6GK1 901-1BB10-2AA0</b> <b>6GK1 901-1BB10-2AB0</b> <b>6GK1 901-1BB10-2AE0</b>
<b>PROFIBUS/PROFINET bus components</b> For establishing MPI/PROFIBUS/PROFINET communication	<b>See Catalogs IK PI, CA 01</b>

# Fail-safe automation with SIMATIC CPUs for factory automation

## CPU 319F-3 PN/DP

### Overview



- The fail-safe CPU with high-performance command processing, large program memory and large quantity structure for demanding applications
- For constructing a fail-safe automation system for plants with increased safety requirements
- Complies with safety requirements up to SIL 3 according to IEC 61508, PL e according to 13849-1, and up to Cat. 4 according to EN 954-1
- Fail-safe I/O modules can be connected decentralized over the integrated PROFINET interface (PROFIsafe) and/or over the integrated PROFIBUS DP interface (PROFIsafe);
- Fail-safe I/O modules of ET200M can also be connected centrally
- Standard modules for non-safety-related applications can be operated centrally and decentralized
- Distributed intelligence in Component Based Automation (CBA) on PROFINET
- Isochronous mode on PROFIBUS
- PROFINET proxy for intelligent devices on PROFIBUS DP in Component based Automation (CBA)

SIMATIC Micro Memory Card required for operation of CPU.

### Application

The CPU 319F-3 PN/DP is the fastest S7-300 CPU with a large program memory. It is ideally suited to plants with extensive automation tasks and stringent safety requirements.

It can be used as a PROFINET IO controller and as a standard PROFIBUS DP master in the SIMATIC S7-300. The CPU 319F-3 PN/DP can also be used as distributed intelligence (DP slave).

Distributed I/O devices with fail-safe I/O modules can be connected over the three integrated interfaces. The fail-safe I/O modules of the ET200M can also be used centrally for safety-related applications.

The integrated communication options of the CPU support networked automation solutions (also fail-safe) without the need for additional components.

### Design

The CPU 319F-3 PN/DP features:

- High command processing and communication performance

- 2.5 MB main memory;  
The extensive main memory for runtime-relevant program sections offers sufficient space for user programs. In the case of safety-related program sections, increased memory requirements (5 times larger) must be expected. SIMATIC Micro Memory Cards (8 MB max.) as load memory for the program also allow the project to be stored in the CPU (complete with symbols and comments) and can be used for data archiving and recipe management.
- Flexible expansion capability;  
max. 32 modules (4-tier configuration)
- Combined MPI/DP interface;  
The first integrated MPI/DP interface can establish up to 32 connections simultaneously to the S7-300/400 or connections to PGs, PCs and OPs. One of the connections is permanently reserved for the PG and one for the OP. With MPI, a simple network can be constructed with up to 32 CPUs using "global data communication". This interface can be reconfigured from an MPI to a DP interface. The DP interface can be used as a DP master or as a DP slave. PROFIBUS DP interface: The PROFIBUS DP V1 standard is supported in full. This enhances the diagnostics and parameterization capability of DP V1 standard slaves.
- DP interface;  
the second integrated DP interface can establish up to 32 connections simultaneously to the S7-300/400 or connections to PGs, PCs and OPs. One of the connections is permanently reserved for the PG and one for the OP. The DP interface can also be used as a DP master or as a DP slave. PROFIBUS DP slaves can be operated isochronously on this interface. The PROFIBUS DP V1 standard is supported in full. This enhances the diagnostics and parameterization capability of DP V1 standard slaves.
- Ethernet interface;  
the third integrated interface of the CPU 319F-3 PN/DP is a PROFINET interface based on Ethernet TCP/IP. It supports the following protocols:
  - S7 communication for the exchange of data between SIMATIC controllers
  - PG/OP communication for programming, start-up and diagnostics through STEP 7
  - PG/OP communication for connection to HMI and SCADA
  - Open TCP/IP, UDP and ISO-on-TCP (RFC1006) communication over PROFINET
  - SIMATIC NET OPC server for communication with other controllers and I/O devices with an integrated CPU

### Function

- Password protection;  
a password concept protects the user program from unauthorized access.
- Diagnostics buffer;  
the last 100 error and interrupt events are stored in a buffer for diagnostic purposes.
- Maintenance-free data back-up;  
all data (up to 700 KB) are automatically backed up by the CPU if the voltage is interrupted and are available unchanged after the voltage has been reconnected.

### Parameterizable properties

The S7 configuration as well as the properties and response of the CPUs can be parameterized using STEP 7:

- MPI multipoint interface;  
determining station addresses
- Start-up/cyclic response;  
determining maximum cycle time and loading
- Isochronous interrupts;  
setting of DP master system, partial process image number and delay time
- Clock bit memory;  
setting of addresses

# Fail-safe automation with SIMATIC

## CPUs for factory automation

### CPU 319F-3 PN/DP

- Retentivity; setting of retentive areas
- Clock interrupts; setting of start date, start time and periodicity
- Watchdog interrupts; setting of periodicity
- System diagnostics; determining handling and scope of the diagnostic alarms
- Clock; setting the type of synchronization in the AS or on the MPI
- Protection level; specifying the access rights to program and data
- Operation; selection of either test operation or process operation
- Communication; reserving the connection resources
- PROFIBUS DP master/slave interfaces; user-oriented address assignment for distributed I/O
- PROFINET interface; parameterization of time synchronization with NTP procedure

#### Information and display functions

- Status and error indications; LEDs indicate hardware, programming, time, I/O and bus errors and operating statuses such as RUN, STOP and starting.
- Test functions; the PG is used to indicate signal status during program execution, to modify process variables independently of the user program and to output the contents of stack memories.
- Information functions; the PG can be used to obtain information about the memory capacity and operating mode of the CPU, the current loading of the work and load memory, current cycle times and diagnostics buffer content in plain text.

#### Integrated communication functions

- PG/OP communication
- Global data communication
- S7 basic communication
- S7 communication
- S5-compatible communication
- Routing
- PROFIBUS DP master/slave
- Open communication over TCP/IP, UDP and ISO-on-TCP (RFC1006)
- PROFINET IO controller
- PROFINET CBA
- System functions; the CPU offers a number of comprehensive system functions for diagnosis, parameterization, synchronization, interrupts, time measurement, etc. Further details can be found in the manual.

#### Communication

The safety related and standard communication between the central controller and the distributed stations takes place over PROFIBUS DP and/or PROFINET. The specially developed PROFIsafe profile supports the transfer of user data for the safety functions within the standard data message frame. Additional hardware components, e.g. special safety buses are not required. The necessary software is either integrated in the hardware components as an expansion of the operating system or loaded into the CPU later as a certified software block.

#### Mode of operation

The safety functions of the F-CPU are included in the F program of the CPU and in the fail-safe signal modules. The signal

modules monitor the output and input signals by means of discrepancy analysis and the injection of test signals.

The CPU checks the proper operation of the controller by means of periodic self-tests, command tests and logic-based and time-based program execution checks. Furthermore, the I/O is checked using requests for signs of life.

If an error is diagnosed in the system, the system will be placed in a safe state.

An F runtime license is not required to operate the CPU 319F-3 PN/DP.

#### Programming

The CPU 319F-3 PN/DP is programmed in the same manner as the other SIMATIC S7 systems. The user program for non-fail-safe plant sections is created using familiar programming tools, e.g. STEP 7.

#### SIMATIC S7 Distributed Safety option package

The STEP 7 option package "SIMATIC S7 Distributed Safety" is required for programming the safety-related program components. The package contains all the functions and blocks required to create an F program.

The F program with the safety functions is connected in F FBD or F LAD or using special functions from the F library. Use of F FBD or F LAD simplifies configuration and programming of the plant and also acceptance testing thanks to the non-plant-specific uniform presentation form. The programmer can concentrate on configuration of the safety-related application without the need to use additional tools.

#### Technical specifications

Order No.	6ES7 318-3FL01-0AB0
<b>Product version</b> associated programming package	STEP 7 V 5.5 or higher, Distributed Safety V 5.4 SP4
<b>Supply voltages</b> Rated value	
• permissible range, lower limit (DC)	19.2 V
external protection for supply cables (recommendation)	Min. 2 A
<b>Current consumption</b> Current consumption (rated value)	1 250 mA
Current consumption (in no-load operation), typ.	500 mA
Inrush current, typ.	4 A
$I^2t$	1.2 A <sup>2</sup> ·s
<b>Power losses</b> Power loss, typ.	14 W
<b>Memory</b> Work memory	
• integrated	2 560 Kbyte
• expandable	No
• Size of retentive memory for retentive data blocks	700 Kbyte
Load memory	
• pluggable (MMC)	Yes
• pluggable (MMC), max.	8 Mbyte
Backup	
• present	Yes
• without battery	Yes
<b>CPU-blocks</b> DB	
• Number, max.	4 096; Number range: 1 to 16000
• Size, max.	64 Kbyte
FB	
• Number, max.	4 096; Number range: 0 to 7999



# Fail-safe automation with SIMATIC

## CPUs for factory automation

### CPU 319F-3 PN/DP

Order No.	6ES7 318-3FL01-0AB0
• Size, max.	64 Kbyte
FC	
• Number, max.	4 096; Number range: 0 to 7999
• Size, max.	64 Kbyte
OB	
• Size, max.	64 Kbyte
Nesting depth	
• per priority class	16
• additional within an error OB	4
<b>CPU processing times</b>	
for bit operations, min.	0.004 µs
for word operations, min.	0.01 µs
for fixed point arithmetic, min.	0.01 µs
for floating point arithmetic, min.	0.04 µs
<b>Counters, timers and their retentivity</b>	
S7 counter	
• Number	2 048
• Retentivity	
- can be set	Yes
- lower limit	0
- upper limit	2 047
• Counting range	
- can be set	Yes
- lower limit	0
- upper limit	999
IEC counter	
• present	Yes
• Type	SFB
S7 times	
• Number	2 048
• Retentivity	
- can be set	Yes
- lower limit	0
- upper limit	2 047
- preset	no retentivity
• Time range	
- lower limit	10 ms
- upper limit	9 990 s
IEC timer	
• present	Yes
• Type	SFB
<b>Data areas and their retentivity</b>	
Flag	
• Number, max.	8 192 byte
• Retentivity available	Yes; MB 0 to MB 8191
• Number of clock memories	8; 1 memory byte
Data blocks	
• Number, max.	4 096; Number range: 1 to 16000
• Size, max.	64 Kbyte
• Retentivity adjustable	Yes; via non-retain property on DB
• Retentivity preset	yes
Local data	
• per priority class, max.	32 768 byte; 2048 bytes max. per block
<b>Address area</b>	
I/O address area	
• overall	8 192 byte
• Outputs	8 192 byte
• of which, distributed	

Order No.	6ES7 318-3FL01-0AB0
- Inputs	8 192 byte
- Outputs	8 192 byte
Process image	
• Inputs	8 192 byte
• Outputs	8 192 byte
• Inputs, adjustable	8 192 byte
• Outputs, adjustable	8 192 byte
• Inputs, default	1 024 byte
• Outputs, default	1 024 byte
Subprocess images	
• Number of subprocess images, max.	1; With PROFINET IO, length of user data is limited to 1600 bytes
Digital channels	
• Inputs	65 536
• Outputs	65 536
• Inputs, of which central	1 024
• Outputs, of which central	1 024
Analog channels	
• Inputs	4 096
• Outputs	4 096
• Inputs, of which central	256
• Outputs, of which central	256
<b>Hardware configuration</b>	
Racks, max.	4
Modules per rack, max.	8
Number of DP masters	
• integrated	2
• via CP	4
Number of operable FMs and CPs (recommended)	
• FM	8
• CP, point-to-point	8
• CP, LAN	10
<b>Time of day</b>	
Clock	
• Hardware clock (real-time clock)	Yes
• battery-backed and synchronizable	Yes
• Behavior of the clock following POWER-ON	Clock continues running after POWER OFF
• Behavior of the clock following expiry of backup period	The clock continues at the time of day it had when power was switched off
• Deviation per day, max.	10 s; typ.: 2 s
Runtime meter	
• Number	4
• Number/Number range	0 to 3
• Range of values	0 to 2 <sup>31</sup> hours (when using SFC 101)
• Granularity	1 hour
• retentive	Yes; must be restarted at each restart
Clock synchronization	
• supported	Yes
• to MPI, master	Yes
• to MPI, slave	Yes
• to DP, master	Yes; on DP slave only time-of-day slave
• to DP, slave	Yes
• in AS, master	Yes
• in AS, slave	Yes
• on Ethernet via NTP	Yes; as client
<b>S7 message functions</b>	
Number of login stations for message functions, max.	32; Depending on the connections configured for PG/OP and S7 basic communication

# Fail-safe automation with SIMATIC

## CPUs for factory automation

### CPU 319F-3 PN/DP

Order No.	6ES7 318-3FL01-0AB0
Process diagnostic messages	Yes
simultaneously active Alarm-S blocks, max.	300
<b>Test commissioning functions</b>	
Status/control	
• Status/control variable	Yes
• Variables	Inputs, outputs, memory bits, DB, times, counters
• Number of variables, max.	30
• of which status variables, max.	30
• of which control variables, max.	14
Forcing	
• Forcing	Yes
Status block	Yes; up to 2 simultaneously
Single step	Yes
Number of breakpoints	4
Diagnostic buffer	
• present	Yes
• Number of entries, max.	500
- can be set	No
- Of which powerfail-proof	100
• Number of entries readable in RUN, max.	499
- adjustable	Yes; From 10 to 499
- preset	10
Service data	
• can be read out	Yes
<b>Monitoring functions</b>	
Status LEDs	Yes
<b>Communication functions</b>	
PG/OP communication	Yes
Data record routing	Yes
Routing	Yes
Global data communication	
• supported	Yes
• Size of GD packets, max.	22 byte
S7 basic communication	
• supported	Yes
S7 communication	
• supported	Yes
S5-compatible communication	
• supported	Yes; via CP and loadable FC
Web server	
• supported	Yes
• Number of HTTP clients	5
• User-defined websites	Yes
Open IE communication	
• TCP/IP	Yes; via integrated PROFINET interface and loadable FBs
- Number of connections, max.	32
• ISO-on-TCP (RFC1006)	Yes; via integrated PROFINET interface and loadable FBs
- Number of connections, max.	32
- Data length, max.	32 768 byte
• UDP	Yes; via integrated PROFINET interface and loadable FBs
- Number of connections, max.	32
- Data length, max.	1 472 byte

Order No.	6ES7 318-3FL01-0AB0
Number of connections	
• overall	32
• usable for PG communication	31
• usable for OP communication	31
• usable for S7 basic communication	30
• usable for S7 communication	16
- reserved for S7 communication	0
- Adjustable for S7 communication, min.	0
- Adjustable for S7 communication, max.	16
• Max. total number of instances	32
• usable for routing	X1 as MPI: max. 10; X1 as DP master: max. 24; X1 as DP slave (active): max. 14; X2 as DP master: max. 24; X2 as DP slave (active): max. 14; X3 as PROFINET: 48 max.
PROFINET CBA (at set setpoint communication load)	
• Setpoint for the CPU communication load	20 %
• Number of remote interconnection partners	32
• Number of functions, master/slave	50
• Total of all Master/Slave connections	3 000
• Data length of all incoming connections master/slave, max.	24 000 byte
• Data length of all outgoing connections master/slave, max.	24 000 byte
• Number of device-internal and PROFIBUS interconnections	1 000
• Data length of device-internal und PROFIBUS interconnections, max.	8 000 byte
• Data length per connection, max.	1 400 byte
• Remote interconnections with acyclic transmission	
- Sampling frequency: Sampling time, min.	200 ms
- Number of incoming interconnections	100
- Number of outgoing interconnections	100
- Data length of all incoming interconnections, max.	3 200 byte
- Data length of all outgoing interconnections, max.	3 200 byte
- Data length per connection, max.	1 400 byte
• Remote interconnections with cyclic transmission	
- Transmission frequency: Transmission interval, min.	1 ms
- Number of incoming interconnections	300
- Number of outgoing interconnections	300
- Data length of all incoming interconnections, max.	4 800 byte
- Data length of all outgoing interconnections, max.	4 800 byte
- Data length per connection, max.	450 byte
• HMI variables via PROFINET (acyclic)	
- Number of stations that can log on for HMI variables (PN OPC/iMap)	3; 2x PN OPC/1x iMap

# Fail-safe automation with SIMATIC

## CPUs for factory automation

### CPU 319F-3 PN/DP

Order No.	6ES7 318-3FL01-0AB0
- HMI variable updating	500 ms
- Number of HMI variables	600
- Data length of all HMI variables, max.	9 600 byte
• PROFIBUS proxy functionality	
- supported	Yes
- Number of linked PROFIBUS devices	32
- Data length per connection, max.	240 byte; slave-dependent
<b>1st interface</b>	
Type of interface	Integrated RS 485 interface
Physics	RS 485
Isolated	Yes
Power supply to interface (15 to 30 V DC), max.	150 mA
Functionality	
• MPI	Yes
• DP master	Yes
• DP slave	Yes
• Point-to-point connection	No
<b>MPI</b>	
• Services	
- PG/OP communication	Yes
- Routing	Yes
- Global data communication	Yes
- S7 basic communication	Yes
- S7 communication	Yes
- S7 communication, as client	No; but via CP and loadable FB
- S7 communication, as server	Yes
• Transmission rate, max.	12 Mbit/s
<b>DP master</b>	
• Services	
- PG/OP communication	Yes
- Routing	Yes
- Global data communication	No
- S7 basic communication	Yes; I blocks only
- S7 communication	Yes
- S7 communication, as client	No
- S7 communication, as server	Yes
- Equidistance mode support	Yes
- Isochronous mode	No
- SYNC/FREEZE	Yes
- Activation/deactivation of DP slaves	Yes
- Number of DP slaves that can be simultaneously activated/deactivated, max.	8
- Direct data exchange (slave-to-slave communication)	Yes; As subscriber
- DPV1	Yes
• Transmission rate, max.	12 Mbit/s
• Number of DP slaves, max.	124
• Address area	
- Inputs, max.	8 Kbyte
- Outputs, max.	8 Kbyte
• User data per DP slave	
- Inputs, max.	244 byte
- Outputs, max.	244 byte
<b>DP slave</b>	
• Services	
- PG/OP communication	Yes
- Routing	Yes; with interface active
- Global data communication	No
- S7 basic communication	No
- S7 communication	Yes
- S7 communication, as client	No

Order No.	6ES7 318-3FL01-0AB0
S7 communication, as server	Yes; connection configured on one side only
- Direct data exchange (slave-to-slave communication)	Yes
- DPV1	No
• Transmission rate, max.	12 Mbit/s
• Transfer memory	
- Inputs	244 byte
- Outputs	244 byte
• Address area, max.	32
• User data per address area, max.	32 byte
<b>2nd interface</b>	
Type of interface	integrated RS 485 interface
Physics	RS 485
Isolated	Yes
Power supply to interface (15 to 30 V DC), max.	200 mA
Functionality	
• MPI	No
• DP master	Yes
• DP slave	Yes
• PROFINET IO Controller	No
• PROFINET IO Device	No
• PROFINET CBA	No
• Web server	No
<b>DP master</b>	
• Services	
- PG/OP communication	Yes
- Routing	Yes
- Global data communication	No
- S7 basic communication	Yes; I blocks only
- S7 communication	Yes
- S7 communication, as client	No
- S7 communication, as server	Yes; connection configured on one side only
- Equidistance mode support	Yes
- Isochronous mode	Yes; OB 61 - isochronous mode is possible either on DP or PROFINET IO (not simultaneously)
- SYNC/FREEZE	Yes
- Activation/deactivation of DP slaves	Yes
- Number of DP slaves that can be simultaneously activated/deactivated, max.	8
- Direct data exchange (slave-to-slave communication)	Yes; As subscriber
- DPV1	Yes
• Transmission rate, max.	12 Mbit/s
• Number of DP slaves, max.	124
• Address area	
- Inputs, max.	8 Kbyte
- Outputs, max.	8 Kbyte
• User data per DP slave	
- Inputs, max.	244 byte
- Outputs, max.	244 byte
<b>DP slave</b>	
• Services	
- PG/OP communication	Yes
- Routing	Yes; with interface active
- Global data communication	No
- S7 basic communication	No
- S7 communication, as client	No
- S7 communication, as server	Yes; connection configured on one side only
- Direct data exchange (slave-to-slave communication)	Yes

# Fail-safe automation with SIMATIC

## CPUs for factory automation

### CPU 319F-3 PN/DP

Order No.	6ES7 318-3FL01-0AB0
- DPV1	No
• GSD file	The current GSD file can be obtained from: <a href="http://www.siemens.com/profibus-gsd">http://www.siemens.com/profibus-gsd</a>
• Transmission rate, max.	12 Mbit/s
• Automatic baud rate search	Yes; only with passive interface
• Transfer memory	
- Inputs	244 byte
- Outputs	244 byte
• Address area, max.	32
• User data per address area, max.	32 byte
<b>3rd Interface</b>	
Type of interface	PROFINET
Physics	Ethernet RJ45
Isolated	Yes
Integrated switch	Yes
Number of ports	2
automatic detection of transmission speed	Yes; 10/100 Mbit/s
Autonegotiation	Yes
Autocrossing	Yes
Media redundancy	
• supported	Yes
• Switchover time on line break, typically	200 ms; PROFINET MRP
• Number of stations in the ring, max.	50
Change of IP address at runtime, supported	Yes
Functionality	
• MPI	No
• DP master	No
• DP slave	No
• PROFINET IO Controller	Yes; also simultaneously with I-Device functionality
• PROFINET IO Device	Yes; also simultaneously with IO controller functionality
• PROFINET CBA	Yes
• Open IE communication	Yes; via TCP/IP, ISO on TCP and UDP
• Web server	Yes
- Number of HTTP clients	5
PROFINET IO Controller	
• Services	
- Isochronous mode	Yes; OB 61 - isochronous mode is possible either on DP or PROFINET IO (not simultaneously)
• Max. number of connectable IO devices for RT	256
- of which in line, max.	256
• Number of IO devices with IRT and the option "high flexibility"	256
- of which in line, max.	61
• Number of IO Devices with IRT and the option "high performance", max.	64
- of which in line, max.	64
• IRT, supported	Yes
• Shared device, supported	Yes
• Prioritized startup supported	Yes
- Number of IO Devices, max.	32

Order No.	6ES7 318-3FL01-0AB0
• Activation/deactivation of IO Devices	Yes
- Number of IO Devices that can be simultaneously activated/deactivated, max.	8
• IO Devices changing during operation (partner ports), supported	Yes
- Max. number of IO devices per tool	8
• Device replacement without swap medium	Yes
• Send clock times	250 µs, 500 µs, 1 ms; 2 ms, 4 ms (not in the case of IRT with "high flexibility" option)
• Updating time	250 µs to 512 ms (depending on the operating mode, see Manual "S7-300 CPU 31xC and CPU 31x, Technical Data" for more details)
<b>PROFINET IO Device</b>	
• Services	
- PG/OP communication	Yes
- Routing	Yes
- S7 communication	Yes; With loadable FBs, max. configurable connections: 16, max. number of instances: 32
- Isochronous mode	No
- Open IE communication	Yes; Via TCP/IP, ISO on TCP, UDP
- IRT, supported	Yes
- PROFlenergy, supported	Yes; With SFB 73 / 74 prepared for loadable PROFlenergy standard FB for I-Device
- Shared device, supported	Yes
- Number of IO controllers with shared device, max.	2
• Transfer memory	
- Inputs, max.	1 440 byte; per IO Controller with shared device
- Outputs, max.	1 440 byte; per IO controller with shared device
• Submodules	
- Number, max.	64
- User data per submodule, max.	1 024 byte
<b>PROFINET CBA</b>	
• acyclic transmission	Yes
• cyclic transmission	Yes
<b>Open IE communication</b>	
• Open IE communication, supported	Yes
• Number of connections, max.	32
• Local port numbers used at the system end	0, 20, 21, 23, 25, 80, 102, 135, 161, 8080, 34962, 34963, 34964, 65532, 65533, 65534, 65535
• Keep-alive function, supported	Yes
<b>Isochronous mode</b>	
Isochronous mode	Yes; Via 2nd PROFIBUS DP or PROFINET interface
<b>programming</b>	
Programming language	
• STEP 7	Yes; V5.5 or higher
• LAD	Yes
• FBD	Yes
• STL	Yes
• SCL	Yes
• CFC	Yes
• GRAPH	Yes
• HiGraph®	Yes

# Fail-safe automation with SIMATIC

## CPUs for factory automation

CPU 319F-3 PN/DP

<b>Order No.</b>	<b>6ES7 318-3FL01-0AB0</b>
Command set	See instruction list
Nesting levels	8
Know-how protection	
• User program protection/password protection	Yes
• Block encryption	Yes; with S7 block privacy
System functions (SFC)	See instruction list
System function blocks (SFB)	See instruction list
<b>Environmental requirements</b>	
Operating temperature	
• Min.	0 °C
<b>Dimensions and weight</b>	
Dimensions	
• Width	120 mm
• Height	125 mm
• Depth	130 mm
Weight	
• Weight, approx.	1 250 g

# Fail-safe automation with SIMATIC

## CPUs for factory automation

### CPU 319F-3 PN/DP

#### Selection and ordering data

	Order No.
<b>CPU 319F-3 PN/DP</b>	<b>6ES7 318-3FL01-0AB0</b>
Main memory 2.5 MB, power supply 24 V DC, combined MPI/PROFIBUS DP master/slave interface, PROFIBUS DP master/slave interface, Ethernet/PROFINET interface; MMC required	
<b>Distributed Safety V5.4 programming tool</b>	
Task: Software for configuring fail-safe user programs for SIMATIC S7-300F, S7-400F, ET 200S Requirement: STEP 7 V5.3 SP3 and higher	
Floating license	<b>6ES7 833-1FC02-0YA5</b>
Software Update Service	<b>6ES7 833-1FC00-0YX2</b>
<b>Distributed Safety Upgrade</b>	<b>6ES7 833-1FC02-0YE5</b>
From V5.x to V5.4; floating license for 1 user	
<b>SIMATIC Micro Memory Card</b>	
64 KB	<b>6ES7 953-8LF20-0AA0</b>
128 KB	<b>6ES7 953-8LG20-0AA0</b>
512 KB	<b>6ES7 953-8LJ20-0AA0</b>
2 MB	<b>6ES7 953-8LL20-0AA0</b>
4 MB	<b>6ES7 953-8LM20-0AA0</b>
8 MB	<b>6ES7 953-8LP20-0AA0</b>
<b>MPI cable</b>	<b>6ES7 901-0BF00-0AA0</b>
for connection of SIMATIC S7 and PG via MPI; 5 m in length	
<b>Slot number plates</b>	<b>6ES7 912-0AA00-0AA0</b>
<b>S7-300 manual</b>	
Design, CPU data, module data, instruction list	
German	<b>6ES7 398-8FA10-8AA0</b>
English	<b>6ES7 398-8FA10-8BA0</b>
French	<b>6ES7 398-8FA10-8CA0</b>
Spanish	<b>6ES7 398-8FA10-8DA0</b>
Italian	<b>6ES7 398-8FA10-8EA0</b>
<b>SIMATIC Manual Collection</b>	<b>6ES7 998-8XC01-8YE0</b>
Electronic manuals on DVD, multi-lingual: LOGO!, SIMADYN, SIMATIC bus components, SIMATIC C7, SIMATIC distributed I/O, SIMATIC HMI, SIMATIC Sensors, SIMATIC NET, SIMATIC PC Based Automation, SIMATIC PCS 7, SIMATIC PG/PC, SIMATIC S7, SIMATIC Software, SIMATIC TDC	
<b>SIMATIC Manual Collection update service for 1 year</b>	<b>6ES7 998-8XC01-8YE2</b>
Current "Manual Collection" DVD and the three subsequent updates	
<b>Power supply connector</b>	<b>6ES7 391-1AA00-0AA0</b>
10 units, spare part	

	Order No.
<b>Manual "Communication for SIMATIC S7-300/-400"</b>	
German	<b>6ES7 398-8EA00-8AA0</b>
English	<b>6ES7 398-8EA00-8BA0</b>
French	<b>6ES7 398-8EA00-8CA0</b>
Spanish	<b>6ES7 398-8EA00-8DA0</b>
Italian	<b>6ES7 398-8EA00-8EA0</b>
<b>PC adapter USB</b>	<b>6ES7 972-0CB20-0XA0</b>
for connecting a PC to SIMATIC S7-200/300/400 via USB; with USB cable (5 m)	
<b>PROFIBUS bus components</b>	
<b>PROFIBUS DP bus connector RS 485</b>	
<ul style="list-style-type: none"> <li>with 90° cable outlet, max. transfer rate 12 Mbit/s               <ul style="list-style-type: none"> <li>without PG interface</li> <li>with PG interface</li> </ul> </li> <li>with 90° cable outlet for FastConnect connection system, max. transfer rate 12 Mbit/s               <ul style="list-style-type: none"> <li>without PG interface, 1 unit</li> <li>without PG interface, 100 units</li> <li>with PG interface, 1 unit</li> <li>with PG interface, 100 units</li> </ul> </li> <li>with axial cable outlet for SIMATIC OP, for connecting to PPI, MPI, PROFIBUS</li> </ul>	<b>6ES7 972-0BA12-0XA0</b> <b>6ES7 972-0BB12-0XA0</b>  <b>6ES7 972-0BA52-0XA0</b> <b>6ES7 972-0BA52-0XB0</b> <b>6ES7 972-0BB52-0XA0</b> <b>6ES7 972-0BB52-0XB0</b> <b>6GK1 500-0EA02</b>
<b>PROFIBUS Fast Connect bus cable</b>	<b>6XV1 830-0EH10</b>
Standard type with special design for quick mounting, 2-core, shielded, sold by the meter, max. delivery unit 1000 m, minimum ordering quantity 20 m	
<b>RS 485 repeater for PROFIBUS</b>	<b>6ES7 972-0AA01-0XA0</b>
Transfer rate up to 12 Mbit/s; 24 V DC; IP20 enclosure	
<b>PROFINET bus components</b>	
<b>IE FC TP standard cable GP 2x2</b>	<b>6XV1 840-2AH10</b>
4-core, shielded TP installation cable for connection to IE FC Outlet RJ45/ IE FC RJ45 Plug; PROFINET-compatible; with UL approval; Sold by the meter	
<b>FO Standard Cable GP (50/125)</b>	<b>6XV1 873-2A</b>
Standard cable, splittable, UL approval, sold by the meter	
<b>SCALANCE X204-2 Industrial Ethernet Switch</b>	<b>6GK5 204-2BB10-2AA3</b>
Industrial Ethernet Switches with integral SNMP access, Web diagnostics, copper cable diagnostics and PROFINET diagnostics for configuring line, star and ring topologies; four 10/100 Mbit/s RJ45 ports and two FO ports	

# Fail-safe automation with SIMATIC

## CPUs for factory automation

CPU 319F-3 PN/DP

	Order No.
<b>Compact Switch Module</b> <b>CSM 377</b> Unmanaged switch for connecting a SIMATIC S7-300, ET200 M and up to three other participants to Industrial Ethernet with 10/100 Mbit/s; 4 x RJ45 ports; external 24 V DC power supply, LED diagnostics, S7-300 module incl. electronic manual on CD-ROM	<b>6GK7 377-1AA00-0AA0</b>
<b>IE FC RJ45 plugs</b> RJ45 plug connector for Industrial Ethernet with a rugged metal enclosure and integrated insulation displacement contacts for connecting Industrial Ethernet FC installation cables	
<b>IE FC RJ45 plug 145</b> 145° cable outlet 1 unit 10 units 50 units	<b>6GK1 901-1BB30-0AA0</b> <b>6GK1 901-1BB30-0AB0</b> <b>6GK1 901-1BB30-0AE0</b>
<b>IE FC RJ45 plug 180</b> 180° cable outlet 1 unit 10 units 50 units	<b>6GK1 901-1BB10-2AA0</b> <b>6GK1 901-1BB10-2AB0</b> <b>6GK1 901-1BB10-2AE0</b>
<b>PROFIBUS/PROFINET bus components</b> For establishing MPI/PROFIBUS/PROFINET communication	<b>See Catalogs IK PI, CA 01</b>

# Fail-safe automation with SIMATIC

## CPUs for factory automation

### CPU 317TF-2 DP

#### Overview



- Fail-safe SIMATIC CPU with integral Technology/Motion Control functionality
- With full functionality of the standard CPU 317-2 DP and CPU 317F-2 DP
- For cross-industry automation tasks in series machine, special machine and plant construction
- Ideal for synchronized motion, such as coupling to a virtual/real master, gear synchronization, cam disk, path interpolation, or print mark compensation
- 3D path interpolation with different kinematics
- Used as central controller in production lines with central and distributed I/O
- Distributed intelligence in Component Based Automation (CBA) on PROFIBUS DP
- With integrated I/O for high-speed technology functions (e.g. camming, reference point acquisition)
- PROFIBUS DP (DRIVE) interface for isochronous connection of drive components
- One common S7 user program for control and motion control tasks (no additional programming language necessary for motion control)
- "S7-Technology" option package required
- "S7 Distributed Safety" option package required

SIMATIC Micro Memory Card (8 MB) required for operation of the CPU.

#### Application

The CPU 317TF-2 DP is a controller that enables motion control, standard and safety tasks to be performed in one controller. It is used in machines where a controller with a large program memory and high processing speed is confronted by motion control requirements at the same time, e.g.:

- Processing/assembly lines
- Palletizers
- Handling systems
- Carton erectors
- Flying shears
- Bottling plants
- Wrapping
- Simple labeling machines
- Roll feeds
- Portals with interpolation

The typical application for motion control functions is for 3-8 axes. The maximum number of axes is 32. Along with accurate single axis positioning, the module is suitable primarily for

complex motion sequences such as coupling to form a virtual or actual master, gearing, cam, path interpolation or print mark correction.

As a result of its capacity, the CPU 317TF-2 DP is ideal for the use of SIMATIC Engineering Tools, e.g.

- Programming with SCL
- Machining step programming with S7-GRAPH

#### Design

The CPU 317TF-2 DP has the same functionality as the high-performance CPU 317 as well as additional integrated functions for technology/motion control. Integrated, fast I/O for technical functions such as cam switching or home position detection round off the performance range the module. Thanks to the integration of Safety Integrated, the controller for safety-oriented applications complies with the high safety requirements according to the relevant standards EN 954-1 up to Cat. 4, IEC 62061 up to SIL 3, and EN ISO 13849-1 up to PL e.

For the fail-safe applications, the STEP 7 option package Distributed Safety provides ready-made TÜV-certified library blocks, e.g. for emergency-stop, two-hand control, muting and door monitoring.

The CPU 317TF-2 DP is equipped with the following:

- Microprocessor; the processor achieves a processing time of approximately 100 ns per binary instruction and 2  $\mu$ s per floating-point operation. The CPU 317TF-2 DP reaches very high processing speeds, particularly where word or double-word commands and 32 bit fixed-point commands are concerned.
- 1.5 MB main memory; the extensive main memory for runtime-relevant program sections offers sufficient space for user programs. SIMATIC Micro Memory Cards (8 MB max.) as load memory for the program also allow the project to be stored in the CPU (complete with symbols and comments) and can be used for data archiving and recipe management.
- Integrated inputs and outputs for technical functions; 4 digital inputs and 8 digital outputs, can be used for technical functions such as home position detection (BERO) or rapid cam switching signals. The digital inputs can also be used (with some restrictions) in the STEP 7 user program.
- Flexible expansion; up to 8 modules (single-tier configuration)
- Combined MPI/DP interface; the first integrated MPI/DP interface can establish up to 32 connections simultaneously to the S7-300/400 or connections to PGs, PCs and OPs. One of these connections is always reserved for the PG and another one for the OP. A simple network with up to 32 CPUs can be configured with the MPI and "global data communication". This interface can be reconfigured from an MPI to a PROFIBUS DP interface. The DP interface can be used as a DP master or as a DP slave.
- PROFIBUS DP (DRIVE) interface; the PROFIBUS DP (DRIVE) interface supports isochronous mode and therefore provides an essential requirement to control high-speed and time-critical operations, such as are found in distributed axes in synchronized applications. The interface can only be used as a DP master. It serves to connect drive components. DP-V0 slaves can also be operated on the DP(DRIVE) spur on a limited basis in addition to drive systems. The connectable drives are specified in the technical specifications.

A list of the drives that can be operated on the DP-Drive can be found at:

<http://support.automation.siemens.com>



### Function

The CPU 317TF-2 DP has the full functionality of the CPU 317F-2 DP. In addition, high-performance motion control functions are available.

The programming is carried out with STEP 7 as well as the option package S7-Technology.

In S7 Technology V4.2 or higher, the following kinematics are supported:

- Cartesian (two and three-dimensional)
- Roll picker
- Scara
- Articulated arm
- Delta2D picker
- Delta3D picker

The following motion control functions can be used with the CPU 317TF-2 DP:

- Basic functions
  - MC\_ReadSysParameter
  - MC\_Reset
  - MC\_WriteParameter
- Single-axis functions
  - MC\_ChangeDataset
  - MC\_Halt
  - MC\_Home
  - MC\_MoveAbsolute
  - MC\_MoveAdditive
  - MC\_MoveRelative
  - MC\_MoveSuperImposed
  - MC\_MoveToEndPos
  - MC\_MoveVelocity
  - MC\_Power
  - MC\_SetTorqueLimitMC\_Stop
  - Synchronous operation functions
    - MC\_CamIn
    - MC\_CamOut
    - MC\_GearIn
    - MC\_GearOut
    - MC\_Phasing
- Superimposed synchronous operation functions
  - MC\_CamInSuperImposed
  - MC\_CamOutSuperImposed
  - MC\_GearInSuperImposed
  - MC\_GearOutSuperImposed
  - MC\_PhasingSuperImposed
- Cam functions
  - MC\_CamClear
  - MC\_CamInterpolate
  - MC\_CamSectorAdd
  - MC\_GetCamPoint
- Other functions
  - MC\_CamSwitch
  - MC\_CamSwitchTime
  - MC\_ExternalEncoder
  - MC\_MeasuringInput
  - MC\_ReadPeriphery
  - MC\_ReadRecord
  - MC\_WritePeriphery
  - MC\_WriteRecord
- Drive functions
  - MC\_DriveDiagnostics
  - MC\_ReadDriveParameter
  - MC\_WriteDriveParameter
- Pressure/Force commands
  - MC\_ForceLimiting
  - MC\_ForceControl
- Path commands
  - MC\_SetCartesianTransform
  - MC\_GroupStop
  - MC\_GroupInterrupt
  - MC\_GroupContinue
  - MC\_MoveLinearAbsolute
  - MC\_MoveLinearRelative
  - MC\_MoveCircularAbsolute
  - MC\_MoveCircularRelative
  - MC\_MovePath
  - MC\_PathSelect
  - MC\_MovePolynomialAbsolute
  - MC\_MovePolynomialRelative
  - MC\_ZoneCheck
  - MC\_GroupSyncConveyorBelt
  - MC\_RedefineTrackingPos
  - MC\_MoveCircles

# Fail-safe automation with SIMATIC

## CPUs for factory automation

### CPU 317TF-2 DP

#### Technical specifications

6ES7 317-6TF14-0AB0	
<b>Product version</b>	
associated programming package	STEP7 V 5.4 SP5 or higher, S7-Technology V4.2 or higher, Distributed Safety V5.4 SP5 or higher, S7-F Configuration Pack V5.5 SP7 or higher
<b>Supply voltages</b>	
Rated value	
• permissible range, lower limit (DC)	20.4 V
external protection for supply cables (recommendation)	Min. 2 A
<b>Current consumption</b>	
Current consumption (in no-load operation), typ.	250 mA
Inrush current, typ.	2.5 A
$I^2t$	1 A <sup>2</sup> -s
<b>Power losses</b>	
Power loss, typ.	6 W
<b>Memory</b>	
Work memory	
• integrated	1 536 Kbyte
• expandable	No
• Size of retentive memory for retentive data blocks	256 Kbyte
Load memory	
• pluggable (MMC)	Yes
• pluggable (MMC), max.	8 Mbyte
Backup	
• present	Yes; guaranteed by MMC (maintenance-free)
• without battery	Yes; Program and data
<b>CPU-blocks</b>	
DB	
• Number, max.	2 047; Number band: 1 to 2047
• Size, max.	64 Kbyte
FB	
• Number, max.	2 048; Sequence of numbers: 0 to 2047
• Size, max.	64 Kbyte
FC	
• Number, max.	2 048; Sequence of numbers: 0 to 2047
• Size, max.	64 Kbyte
OB	
• Size, max.	64 Kbyte
• Number of technology synchronous alarm OBs	1; OB 65
Nesting depth	
• per priority class	16
• additional within an error OB	4
<b>CPU processing times</b>	
for bit operations, min.	0.05 µs
for word operations, min.	0.2 µs
for fixed point arithmetic, min.	0.2 µs
for floating point arithmetic, min.	1 µs
<b>Counters, timers and their retentivity</b>	
S7 counter	
• Number	512; Number range: 0...511
• Retentivity	
- can be set	Yes

6ES7 317-6TF14-0AB0	
• Counting range	
- can be set	Yes
- lower limit	0
- upper limit	999
IEC counter	
• present	Yes
• Type	SFB
S7 times	
• Number	512; Number range: 0 to 511
• Retentivity	
- can be set	Yes
- preset	no retentivity
• Time range	
- lower limit	10 ms
- upper limit	9 990 s
IEC timer	
• present	Yes
• Type	SFB
<b>Data areas and their retentivity</b>	
Flag	
• Number, max.	4 096 byte
• Retentivity available	Yes; MB 0 to MB 4095
• Number of clock memories	8; 1 memory byte
Data blocks	
• Number, max.	2 047; from DB 1 to DB 2047
• Size, max.	64 Kbyte
• Retentivity adjustable	Yes; via non-retain property on DB
• Retentivity preset	yes
Local data	
• per priority class, max.	1 024 byte
<b>Address area</b>	
I/O address area	
• overall	8 192 byte
• Outputs	8 192 byte
• of which, distributed	
- Inputs	8 192 byte
- Outputs	8 192 byte
Process image	
• Inputs, adjustable	2 048 byte
• Outputs, adjustable	2 048 byte
• Inputs, default	1 024 byte
• Outputs, default	1 024 byte
Subprocess images	
• Number of subprocess images, max.	1
Digital channels	
• Inputs	65 536
• Outputs	65 536
• Inputs, of which central	512
• Outputs, of which central	512
Analog channels	
• Inputs	4 096
• Outputs	4 096
• Inputs, of which central	64
• Outputs, of which central	64
<b>Hardware configuration</b>	
Central devices, max.	1
Expansion devices, max.	0
Racks, max.	1
Modules per rack, max.	

# Fail-safe automation with SIMATIC

## CPUs for factory automation

### CPU 317TF-2 DP

6ES7 317-6TF14-0AB0	
Number of DP masters	
• integrated	2; 1 DP and 1 DP (drive)
• via CP	2; for DP
Number of operable FMs and CPs (recommended)	
• FM	8
• CP, point-to-point	8
• CP, LAN	8
<b>Time of day</b>	
Clock	
• Hardware clock (real-time clock)	Yes
• battery-backed and synchronizable	Yes
• Behavior of the clock following POWER-ON	Clock continues running after POWER OFF
• Behavior of the clock following expiry of backup period	The clock continues at the time of day it had when power was switched off
• Deviation per day, max.	10 s
Runtime meter	
• Number	4
• Number/Number range	0 to 3
• Range of values	0 to 2 <sup>31</sup> hours (when using SFC 101)
• Granularity	1 hour
• retentive	Yes; must be restarted at each restart
Clock synchronization	
• supported	Yes
• to MPI, master	Yes
• to MPI, slave	Yes
• to DP, master	Yes
• to DP, slave	Yes; only time-of-day slave
• in AS, master	Yes
• in AS, slave	Yes
<b>S7 message functions</b>	
Number of login stations for message functions, max.	32; Depending on the connections configured for PG/OP and S7 basic communication
Process diagnostic messages	Yes
simultaneously active Alarm-S blocks, max.	60
<b>Test commissioning functions</b>	
Status/control	
• Status/control variable	Yes
• Variables	Inputs, outputs, memory bits, DB, times, counters
• Number of variables, max.	30
• of which status variables, max.	30
• of which control variables, max.	14
Forcing	
• Forcing	Yes
Status block	Yes; up to 2 simultaneously
Single step	Yes
Number of breakpoints	2; without continuation
Diagnostic buffer	
• present	Yes
• Number of entries, max.	100
- can be set	No
- Of which powerfail-proof	100
<b>Monitoring functions</b>	
Status LEDs	Yes

6ES7 317-6TF14-0AB0	
<b>Communication functions</b>	
PG/OP communication	Yes
Routing	Yes
Global data communication	
• supported	Yes
• Size of GD packets, max.	22 byte
S7 basic communication	
• supported	Yes
S7 communication	
• supported	Yes
S5-compatible communication	
• supported	Yes; via CP and loadable FC
Number of connections	
• overall	32
• usable for PG communication	31
• usable for OP communication	31
• usable for S7 basic communication	30
• usable for routing	8
<b>1st interface</b>	
Type of interface	Integrated RS 485 interface
Physics	RS 485
Isolated	Yes
Power supply to interface (15 to 30 V DC), max.	200 mA
Functionality	
• MPI	Yes
• DP master	Yes
• DP slave	Yes
• Point-to-point connection	No
MPI	
• Number of connections	32
• Services	
- PG/OP communication	Yes
- Routing	Yes
- Global data communication	Yes
- S7 basic communication	Yes
- S7 communication	Yes
- S7 communication, as client	No; but via CP and loadable FB
- S7 communication, as server	Yes
• Transmission rate, max.	12 Mbit/s
DP master	
• Services	
- PG/OP communication	Yes
- Routing	Yes
- Global data communication	No
- S7 basic communication	Yes; I blocks only
- S7 communication	Yes
- S7 communication, as client	No; but via CP and loadable FB
- S7 communication, as server	Yes
- Equidistance mode support	Yes
- Isochronous mode	Yes; OB 61
- SYNC/FREEZE	Yes
- Activation/deactivation of DP slaves	Yes
- Number of DP slaves that can be simultaneously activated/deactivated, max.	4
- DPV1	Yes
• Transmission rate, max.	12 Mbit/s
• Number of DP slaves, max.	124
• Address area	
- Inputs, max.	8 192 byte
- Outputs, max.	8 192 byte
• User data per DP slave	

# Fail-safe automation with SIMATIC

## CPUs for factory automation

### CPU 317TF-2 DP

6ES7 317-6TF14-0AB0	
- Inputs, max.	244 byte
- Outputs, max.	244 byte
DP slave	
• Services	
- PG/OP communication	Yes
- Routing	Yes; only with active interface
- Global data communication	No
- S7 basic communication	No
- S7 communication	Yes; only server, configured on one side only
- S7 communication, as client	Yes; but via CP and loadable FB
- S7 communication, as server	Yes; connection configured on one side only
- Direct data exchange (slave-to-slave communication)	Yes
- DPV1	No
• GSD file	<a href="http://www.siemens.com/profibus-gsd">http://www.siemens.com/profibus-gsd</a>
• Transmission rate, max.	12 Mbit/s
• Transfer memory	
- Inputs	244 byte
- Outputs	244 byte
• Address area, max.	32
• User data per address area, max.	32 byte
<b>2nd interface</b>	
Type of interface	integrated RS 485 interface
Physics	RS 485
Isolated	Yes
Power supply to interface (15 to 30 V DC), max.	200 mA
Functionality	
• MPI	No
• DP master	Yes; DP(DRIVE)-Master
• DP slave	No
• Local Operating Network	No
DP master	
• Services	
- PG/OP communication	No
- Routing	Yes
- Global data communication	No
- S7 basic communication	No
- S7 communication	No
- Equidistance mode support	Yes
- Isochronous mode	Yes
- SYNC/FREEZE	No
- Activation/deactivation of DP slaves	Yes
- DPV1	No
• Transmission rate, max.	12 Mbit/s
• Number of DP slaves, max.	64
• Address area	
- Inputs, max.	1 024 byte
- Outputs, max.	1 024 byte
• User data per DP slave	
- Inputs, max.	244 byte
- Outputs, max.	244 byte
<b>Programming</b>	
Programming language	
• STEP 7	Yes
• LAD	Yes
• FBD	Yes
• STL	Yes
• SCL	Yes
• CFC	Yes
• GRAPH	Yes
• HiGraph®	Yes
Command set	See instruction list

6ES7 317-6TF14-0AB0	
Nesting levels	8
Know-how protection	
• User program protection/password protection	Yes
System functions (SFC)	See instruction list
System function blocks (SFB)	See instruction list
<b>Digital inputs</b>	
Number of digital inputs	4
• of which, inputs usable for technological functions	4
Number of simultaneously controllable inputs	
• horizontal installation	
- up to 40 °C, max.	4
- up to 60 °C, max.	4
• vertical installation	
- up to 40 °C, max.	4
Input characteristic curve acc. to IEC 1131, Type 1	Yes
Input voltage	
• Rated value, DC	24 V
• for signal "0"	-3 to +5 V
• for signal "1"	15 to 30 V
Input current	
• for signal "1", typ.	7 mA
Input delay (for rated value of input voltage)	
• for counter/technological functions	
- at "0" to "1", max.	10 µs; typically
- at "1" to "0", max.	10 µs; typically
Cable length	
• Cable length, shielded, max.	1 000 m
<b>Digital outputs</b>	
Number of digital outputs	8
• of which high-speed outputs	8
Functions	For technology functions, e.g. high-speed cam switch signals
Short-circuit protection	Yes
• Response threshold, typ.	1.0 A
Limitation of inductive shutdown voltage to	48 V
Lamp load, max.	5 W
Controlling a digital input	No
Output voltage	
• for signal "0" (DC), max.	3 V; 2L+
• for signal "1", min.	Rated voltage -2.5 V (2L+)
Output current	
• for signal "1" rated value	0.5 A
• for signal "1" permissible range for 0 to 60 °C, min.	5 mA
• for signal "1" permissible range for 0 to 60 °C, max.	0.6 A
• for signal "0" residual current, max.	0.3 mA
Parallel switching of 2 outputs	
• for increased power	No
• for redundant control of a load	No
Switching frequency	
• with resistive load, max.	100 Hz
• with inductive load, max.	0.2 Hz; to IEC 947-5-1, DC13
• on lamp load, max.	100 Hz

# Fail-safe automation with SIMATIC

## CPUs for factory automation

CPU 317TF-2 DP

6ES7 317-6TF14-0AB0	
Aggregate current of outputs (per group)	
• horizontal installation	4 A
- up to 40 °C, max.	3 A
- up to 60 °C, max.	
• all other mounting positions	3 A
- up to 40 °C, max.	
Load resistance range	
• lower limit	48 Ω
• upper limit	4 kΩ
Cable length	
• Cable length, shielded, max.	1 000 m
<b>Encoder</b>	
Connectable encoders	
• 2-wire BEROs	No
<b>Galvanic isolation</b>	
Galvanic isolation digital inputs	
• between the channels and the backplane bus	Yes
Galvanic isolation digital outputs	
• between the channels and the backplane bus	Yes
<b>Environmental requirements</b>	
Operating temperature	
• Min.	0 °C
<b>Dimensions and weight</b>	
Dimensions	
• Width	160 mm
• Height	125 mm
• Depth	130 mm
Weight	
• Weight, approx.	750 g

### Selection and ordering data

	Order No.
<b>CPU 317TF-2 DP</b>	<b>6ES7 317-6TF14-0AB0</b>
Main memory 1.5 MB, power supply 24 V DC, MPI, PROFIBUS DP master/slave interface, PROFIBUS DP(DRIVE) interface; with Technology/Motion Control functions; MMC required	
<b>S7-Technology V4.2</b>	<b>6ES7 864-1CC42-0YA5</b>
<b>Task:</b> Option package for configuring and programming technology tasks with SIMATIC S7 CPU 31xT-2 DP and the SIMATIC S7 CPU 317TF-2 DP	
<b>Requirement:</b> STEP 7 V5.4 SP5 or higher	
<b>Delivery package:</b> on DVD; incl. documentation for CPU 31xT-2 DP, CPU 317TF-2 DP (included on DVD)	
<b>SIMATIC Micro Memory Card</b>	
8 MB	<b>6ES7 953-8LP20-0AA0</b>
<b>MPI cable</b>	<b>6ES7 901-0BF00-0AA0</b>
for connection of SIMATIC S7 and PG via MPI; 5 m in length	
<b>Front connectors</b>	
40-pin, with screw contacts	
• 1 unit	<b>6ES7 392-1AM00-0AA0</b>
• 100 units	<b>6ES7 392-1AM00-1AB0</b>
40-pin with spring-loaded contacts	
• 1 unit	<b>6ES7 392-1BM01-0AA0</b>
• 100 units	<b>6ES7 392-1BM01-1AB0</b>
40-pin, with FastConnect	
• 1 unit	<b>6ES7 392-1CM00-0AA0</b>
<b>Slot number plates</b>	<b>6ES7 912-0AA00-0AA0</b>
<b>S7-300 manual</b>	
Design, CPU data, module data, instruction list	
German	<b>6ES7 398-8FA10-8AA0</b>
English	<b>6ES7 398-8FA10-8BA0</b>
French	<b>6ES7 398-8FA10-8CA0</b>
Spanish	<b>6ES7 398-8FA10-8DA0</b>
Italian	<b>6ES7 398-8FA10-8EA0</b>
<b>SIMATIC Manual Collection</b>	<b>6ES7 998-8XC01-8YE0</b>
Electronic manuals on DVD, multi-lingual: LOGO!, SIMADYN, SIMATIC bus components, SIMATIC C7, SIMATIC distributed I/O, SIMATIC HMI, SIMATIC Sensors, SIMATIC NET, SIMATIC PC Based Automation, SIMATIC PCS 7, SIMATIC PG/PC, SIMATIC S7, SIMATIC Software, SIMATIC TDC	
<b>SIMATIC Manual Collection update service for 1 year</b>	<b>6ES7 998-8XC01-8YE2</b>
Current "Manual Collection" DVD and the three subsequent updates	
<b>Power supply connector</b>	<b>6ES7 391-1AA00-0AA0</b>
10 units, spare part	

3

# Fail-safe automation with SIMATIC

## CPUs for factory automation

### CPU 317TF-2 DP

	Order No.
<b>Labeling strips</b> 10 units, spare part	<b>6ES7 392-2XX00-0AA0</b>
<b>Label cover</b> 10 units, spare part	<b>6ES7 392-2XY00-0AA0</b>
<b>S7 SmartLabel V3.0</b> Software for automatic labeling of modules direct from the STEP 7 project Single license Upgrade single license	<b>2XV9 450-1SL03-0YX0</b> <b>2XV9 450-1SL03-0YX4</b>
<b>Labeling sheets for machine inscription</b> • for 16-channel signal modules, DIN A4, for printing with laser printer 10 units petrol light-beige yellow red • for 32-channel signal modules, DIN A4, for printing with laser printer 10 units petrol light-beige yellow red	<b>6ES7 392-2AX00-0AA0</b> <b>6ES7 392-2BX00-0AA0</b> <b>6ES7 392-2CX00-0AA0</b> <b>6ES7 392-2DX00-0AA0</b>  <b>6ES7 392-2AX10-0AA0</b> <b>6ES7 392-2BX10-0AA0</b> <b>6ES7 392-2CX10-0AA0</b> <b>6ES7 392-2DX10-0AA0</b>
<b>Manual "Communication for SIMATIC S7-300/-400"</b> German English French Spanish Italian	<b>6ES7 398-8EA00-8AA0</b> <b>6ES7 398-8EA00-8BA0</b> <b>6ES7 398-8EA00-8CA0</b> <b>6ES7 398-8EA00-8DA0</b> <b>6ES7 398-8EA00-8EA0</b>
<b>PC adapter USB</b> for connecting a PC to SIMATIC S7-200/300/400 via USB; with USB cable (5 m)	<b>6ES7 972-0CB20-0XA0</b>
<b>PROFIBUS DP bus connector RS 485</b> • with 90° cable outlet, max. transfer rate 12 Mbit/s - without PG interface - with PG interface • with 90° cable outlet for FastConnect connection system, max. transfer rate 12 Mbit/s - without PG interface, 1 unit - without PG interface, 100 units - with PG interface, 1 unit - with PG interface, 100 units • with axial cable outlet for SIMATIC OP, for connecting to PPI, MPI, PROFIBUS	<b>6ES7 972-0BA12-0XA0</b> <b>6ES7 972-0BB12-0XA0</b>  <b>6ES7 972-0BA52-0XA0</b> <b>6ES7 972-0BA52-0XB0</b> <b>6ES7 972-0BB52-0XA0</b> <b>6ES7 972-0BB52-0XB0</b> <b>6GK1 500-0EA02</b>
<b>PROFIBUS Fast Connect bus cable</b> Standard type with special design for quick mounting, 2-core, shielded, sold by the meter, max. delivery unit 1000 m, minimum ordering quantity 20 m	<b>6XV1 830-0EH10</b>

	Order No.
<b>RS 485 repeater for PROFIBUS</b> Transfer rate up to 12 Mbit/s; 24 V DC; IP20 enclosure	<b>6ES7 972-0AA01-0XA0</b>
<b>PROFIBUS bus components</b> for establishing MPI/PROFIBUS communication	<b>See Catalogs IK PI, CA 01</b>

# Fail-safe automation with SIMATIC CPUs for factory automation

CPU 414F-3 PN/DP

## Overview



- For constructing a fail-safe automation system for plants with increased safety requirements
- CPUs for high demands in the mid-level performance range
- Applicable for plants with additional demands on programming scope and processing speed
- Satisfies safety requirements up to SIL 3 acc. to IEC 61508 and Cat. 4 acc. to EN 954-1
- Standard and safety-related tasks can be performed with a single CPU
- Integrated PROFINET functions in CPU 414F-3 PN/DP
- Multi-processor mode is possible
- Safety-related communication with distributed I/O devices over PROFIBUS DP or PROFINET IO with PROFIsafe profile
- Fail-safe I/O modules can be connected in a distributed manner via the integrated interfaces (DP and PN with CPU 416F-3 PN/DP) and/or through communication modules (CP 443-5 Extended and CP 443-1 Adv.)
- Central and distributed use of standard modules for non-safety-oriented applications

## Application

The CPU 414F-3 PN/DP is a CPU for high demands in the mid-level performance range. They meet higher demands for program scope and instruction processing speed. It permits the design of a fail-safe automation system for plants with increased safety requirements.

The integrated PROFIBUS DP interfaces make it possible to connect directly to the PROFIBUS DP fieldbus as a master or slave.

An additional DP master system can be connected via the IF 964-DP interface module.

For the PROFINET interface of the CPU 414F-3 PN/DP, the switch functionality permits the formation of two externally accessible PROFINET ports. In addition to hierarchical network topologies, this also enables the creation of line structures in the new S7-400 controllers.

### Note:

Only the interface module 6ES7 964-2AA04-0AB0 can be used.

## Design

The CPU 414-3 PN/DP is equipped with the following:

- **Powerful processor:**  
The CPU achieves command execution times as low as 0.045  $\mu$ s per binary instruction.
- **4 MB RAM** (of which 2 MB each for program and data); fast RAM for parts of the user program relevant to execution.
- **Flexible expansion:** Up to 131072 digital and 81932 analog inputs/outputs.
- **Multi-point interface MPI:**  
With the MPI it is possible to establish simple networking of max. 32 stations at a data transmission rate of up to 12 Mbit/s. The CPUs can establish up to 32 connections to stations of the communication bus (C bus) and the MPI.
- **Mode selector switch:**  
Designed as toggle switch.
- **Diagnostics buffer:**  
The last error and interrupt events are retained in a ring buffer for diagnostic purposes. The number of entries can be parameterized.
- **Real-time clock:**  
The date and time are appended to diagnostic messages of the CPUs.
- **Memory card:**  
For expansion of the integrated load memory. The information in the load memory comprises S7-400 parameterization data in addition to the program and therefore requires twice as much memory space. The result is:
  - The integral load memory for large programs is not sufficient, therefore a memory card is frequently required. RAM and FEPRAM cards (FEPRAM for retentive storage) are available.
- **PROFIBUS DP interface and combined MPI/DP interface:**  
The PROFIBUS DP master interface allows a distributed automation configuration offering high speed and ease of use. From the user's point of view, the distributed I/O is treated as central I/O (same configuring, addressing and programming). Mixed configuration: SIMATIC S5 and SIMATIC S7 as PROFIBUS master according to EN 50170.
- **Additional module slot:**  
An additional PROFIBUS DP master system can be connected via the IF 964-DP interface module.
- **PROFINET interface with 2 ports (switch):**
  - PROFINET I/O, 256 IO devices connectable
  - PROFINET CBA

## Function

- **Block protection:**  
A password concept protects the user program from unauthorized access.
- **Integrated HMI services:**  
In the case of HMI devices, the user only has to specify the source and destination of the data. These are automatically transferred cyclically by the system.
- **Integrated communication functions:**
  - PG/OP communication
  - Global data communication
  - S7 basic communication
  - S7 communication
- **Firmware update over the network**
- **Open communication over TCP/IP, UDP and ISO-on-TCP (RFC1006)**
- **Distributed intelligence in Component Based Automation (CBA) on PROFINET**
- **Additional diagnostic option with integrated web server**

# Fail-safe automation with SIMATIC CPUs for factory automation

## CPU 414F-3 PN/DP

### Parameterizable properties

The STEP 7 tool "Hardware Configuration" can be used to program the properties and response of the S7-400 including the CPUs, e.g.

- Multi-point interface MPI:
  - Determining station addresses.
  - Startup/cyclic behavior.
  - Definition of maximum cycle time and communication load.
- Address assignment: Addressing of the I/O modules.
- Retentive areas:
  - Definition of the number of retentive bit memories, counters, timers, data blocks and clock memories.
- Size of the process image, local data.
- Length of the diagnostic buffer.
- Protection level:
  - Definition of access authorization to program and data.
- System diagnostics:
  - Determination of handling and scope of diagnostics messages.
- Cyclic interrupts: Setting periodicity.
- PROFINET interface
- Parameterization of time synchronization with NTP procedure

### Display and information functions

- Status and fault indicators:
  - LEDs indicate, for example, internal and external errors and operating states such as RUN, STOP, start-up and test functions.
- Test Functions:
  - The programming device can be used to display signal states in the program execution sequence, modify process variables independently of the user program, output contents of stack memories, run through program steps individually, and disable program sections.
- Information functions:
  - The user can obtain information about the memory capacity and operating mode of the CPU, and the current utilization of the RAM and load memory.

### Communication

The safety related and standard communication between the central controller and the fail-safe ET 200 modules takes place over PROFIBUS DP and/or PROFINET. The specially developed PROFIBUS profile PROFIsafe allows the transmission of user data associated with the safety function within the standard data telegram. Additional hardware components, e.g. special safety buses, are not required. The necessary software is either integrated into the hardware components as an expansion, or reloaded into the CPU as a certified software block.

### Mode of operation

The safety functions of the F-CPU are included in the F program of the CPU and in the fail-safe signal modules.

The signal modules monitor output and input signals by means of discrepancy analyses and test signal injections.

The CPU checks the proper operation of the controller with regular self-tests, command tests, and logical and chronological program execution checks. In addition, the I/O is checked by means of sign-of-life requests.

If a fault is diagnosed in the system, the system is brought to a safe state.

An F-Runtime license is not required to operate the CPU 414F-3 PN/DP.

### Programming

The CPU 414F-3 PN/DP is programmed in the same manner as the other SIMATIC S7 systems. The user program for non-fail-safe plant sections is created with the field-proven programming tools, e.g. STEP 7.

### SIMATIC S7 Distributed Safety option package

The STEP 7 option package "SIMATIC S7 Distributed Safety" is required for programming the safety-related program components. The package contains all the necessary functions and blocks for creating the F program.

The F program with the safety functions is connected in F FBD or F LAD or using special function blocks from the F library. Use of F FBD or F LAD simplifies configuration and programming of the system and also acceptance testing thanks to the cross-system uniform presentation form. Programmers can concentrate fully on the safety-related application without having to use additional tools.

### Technical specifications

The technical data is available in the Internet: [www.siemens.com/industrymall](http://www.siemens.com/industrymall)

### Selection and ordering data

	Order No.
<b>CPU 414F-3 PN/DP</b>	<b>6ES7 414-3FM06-0AB0</b>
For setting up safety-related automation system; main memory 4 MB, power supply 24 V DC, MPI/PROFIBUS DP master interface, PROFINET interface, slot for memory card, module slot for 1 IF module, incl. slot number labels	
<b>Option package S7 F Distributed Safety V5.4</b>	
for generating fail-safe programs for the S7-300F/400F	
Floating license	<b>6ES7 833-1FC02-0YA5</b>
Upgrade from V5.x to V5.4	<b>6ES7 833-1FC02-0YE5</b>
Software Update Service	<b>6ES7 833-1FC00-0YX2</b>
<b>Memory Card RAM</b>	
64 KB	<b>6ES7 952-0AF00-0AA0</b>
256 KB	<b>6ES7 952-1AH00-0AA0</b>
1 MB	<b>6ES7 952-1AK00-0AA0</b>
2 MB	<b>6ES7 952-1AL00-0AA0</b>
4 MB	<b>6ES7 952-1AM00-0AA0</b>
8 MB	<b>6ES7 952-1AP00-0AA0</b>
16 MB	<b>6ES7 952-1AS00-0AA0</b>
64 MB	<b>6ES7 952-1AY00-0AA0</b>
<b>FEPROM memory card</b>	
64 KB	<b>6ES7952-0KF00-0AA0</b>
256 KB	<b>6ES7952-0KH00-0AA0</b>
1 MB	<b>6ES7 952-1KK00-0AA0</b>
2 MB	<b>6ES7 952-1KL00-0AA0</b>
4 MB	<b>6ES7 952-1KM00-0AA0</b>
8 MB	<b>6ES7 952-1KP00-0AA0</b>
16 MB	<b>6ES7 952-1KS00-0AA0</b>
32 MB	<b>6ES7 952-1KT00-0AA0</b>
64 MB	<b>6ES7 952-1KY00-0AA0</b>



# Fail-safe automation with SIMATIC

## CPUs for factory automation

### CPU 414F-3 PN/DP

	Order No.
<b>MPI cable</b> for connection of SIMATIC S7 and PG via MPI; 5 m in length	<b>6ES7 901-0BF00-0AA0</b>
<b>IF 964-DP interface module</b> For connecting an additional DP line	<b>6ES7 964-2AA04-0AB0</b>
<b>Slot number plates</b> 1 set (spare part)	<b>6ES7 912-0AA00-0AA0</b>
<b>Manual "SIMATIC S7-400 programmable controller"</b> incl. instruction list	
German	<b>6ES7 498-8AA05-8AA0</b>
English	<b>6ES7 498-8AA05-8BA0</b>
<b>S7-400 operation list</b>	
German	<b>6ES7 498-8AA05-8AN0</b>
English	<b>6ES7 498-8AA05-8BN0</b>
<b>Manual "Communication for SIMATIC S7-300/-400"</b>	
German	<b>6ES7 398-8EA00-8AA0</b>
English	<b>6ES7 398-8EA00-8BA0</b>
French	<b>6ES7 398-8EA00-8CA0</b>
Spanish	<b>6ES7 398-8EA00-8DA0</b>
Italian	<b>6ES7 398-8EA00-8EA0</b>
<b>SIMATIC Manual Collection</b> Electronic manuals on DVD, multilingual: LOGO!, SIMADYN, SIMATIC bus components, SIMATIC C7, SIMATIC distributed I/O, SIMATIC HMI, SIMATIC Sensors, SIMATIC NET, SIMATIC PC Based Automation, SIMATIC PCS 7, SIMATIC PG/PC, SIMATIC S7, SIMATIC Software, SIMATIC TDC	<b>6ES7 998-8XC01-8YE0</b>
<b>SIMATIC Manual Collection update service for 1 year</b> Current "Manual Collection" DVD and the three subsequent updates	<b>6ES7 998-8XC01-8YE2</b>
<b>Brochure "SIMATIC S7-400 programmable controller - Design and application"</b>	
German	<b>6ES7 498-8AA00-8AB0</b>
English	<b>6ES7 498-8AA00-8BB0</b>
<b>PROFIBUS bus components</b>	
<b>RS 485 bus connector with 90° cable outlet</b> Max. transfer rate 12 Mbit/s without PG interface With PG interface	<b>6ES7 972-0BA12-0XA0</b> <b>6ES7 972-0BB12-0XA0</b>
<b>RS 485 bus connector with angled cable outlet</b> Max. transfer rate 12 Mbit/s without PG interface With PG interface	<b>6ES7 972-0BA42-0XA0</b> <b>6ES7 972-0BB42-0XA0</b>

	Order No.
<b>RS 485 bus connector with 90° cable outlet for Fast Connect system</b> Max. transfer rate 12 Mbit/s without PG interface • 1 unit • 100 units with PG interface • 1 unit • 100 units	<b>6ES7 972-0BA52-0XA0</b> <b>6ES7 972-0BA52-0XB0</b> <b>6ES7 972-0BB52-0XA0</b> <b>6ES7 972-0BB52-0XB0</b>
<b>RS 485 bus connector with axial cable outlet</b> For SIMATIC OP, for connection to PPI, MPI, PROFIBUS	<b>6GK1 500-0EA02</b>
<b>PROFIBUS FastConnect bus cable</b> Standard type with special design for quick mounting, 2-core, shielded, sold by the meter, max. delivery unit 1000 m, minimum ordering quantity 20 m	<b>6XV1 830-0EH10</b>
<b>RS 485 repeater for PROFIBUS</b> Transfer rate up to 12 Mbit/s; 24 V DC; IP20 enclosure	<b>6ES7 972-0AA01-0XA0</b>
<b>PROFINET bus components</b>	
<b>IE FC TP standard cable GP 2x2</b> 4-core, shielded TP installation cable for connection to IE FC Outlet RJ45/IE FC RJ45 Plug; PROFINET-compatible; with UL approval; Sold by the meter	<b>6XV1 840-2AH10</b>
<b>FO Standard Cable GP (50/125)</b> Standard cable, splittable, UL approval, sold by the meter	<b>6XV1 873-2A</b>
<b>SCALANCE X204-2 Industrial Ethernet Switch</b> Industrial Ethernet Switches with integral SNMP access, Web diagnostics, copper cable diagnostics and PROFINET diagnostics for configuring line, star and ring topologies; four 10/100 Mbit/s RJ45 ports and two FO ports	<b>6GK5 204-2BB10-2AA3</b>
<b>IE FC RJ45 plugs</b> RJ45 plug connector for Industrial Ethernet with a rugged metal enclosure and integrated insulation displacement contacts for connecting Industrial Ethernet FC installation cables	
<b>IE FC RJ45 plug 180</b> 180° cable outlet 1 unit 10 units 50 units	<b>6GK1 901-1BB10-2AA0</b> <b>6GK1 901-1BB10-2AB0</b> <b>6GK1 901-1BB10-2AE0</b>
<b>PROFIBUS/PROFINET bus components</b> For establishing MPI/PROFIBUS/PROFINET communication	<b>See Catalogs IK PI, CA 01</b>

# Fail-safe automation with SIMATIC

## CPUs for factory automation

### CPU 416F

#### Overview



- For constructing a fail-safe automation system for plants with increased safety requirements
- High-performance CPU in the top-end performance range
- Satisfies safety requirements up to SIL 3 acc. to IEC 61508 and Cat. 4 acc. to EN 954-1
- Standard and safety-related tasks can be performed with a single CPU
- Multi-processor mode is possible
- Safety-related communication with distributed I/O devices over PROFIBUS DP with the PROFIsafe profile
- Fail-safe I/O modules can be connected decentralized over the integrated interfaces (DP and PN with CPU416F-3 PN/DP) and/or through communication modules (CP443-5 Ext. and CP443-1 Adv.)
- Standard modules for non-safety-related applications can be operated centrally and decentralized

#### Application

The CPU 416F-2 and the CPU 416F-3 PN/DP are high-performance CPUs of the SIMATIC S7-400. They allow a fail-safe automation system to be constructed for plants with increased safety requirements.

The integrated PROFIBUS DP interfaces of CPU 416F-2 support direct connection to the PROFIBUS DP fieldbus as a master or as a slave.

Another DP master system can be connected in the case of the CPU 416F-3 PN/DP through the IF 964-DP interface module.

The integrated PROFINET interface of the CPU 416F-3 PN/DP implements switch functionality by using the ERTEC 400 ASIC. This forms the basis for provision of 2 externally accessible PROFINET ports. This means that apart from hierarchic network topologies, line structures can also be implemented with the new S7-400 controllers.

#### Note:

Only interface module 6ES7 964-2AA04-0AB0 can be used.

Fail-safe I/O modules can be connected to all integrated interfaces, to IF 964-DP and/or through communication modules (CP443-5 Ext. and CP443-1 Advanced). Safety-related communication is performed over PROFIBUS DP with the PROFIsafe profile.

#### Design

Both CPUs feature:

- High-performance processor:  
The CPUs achieve command runtimes down to 0.03  $\mu$ s per binary instruction.
- CPU 416F-2:  
5.6 MB main memory (of which 2.8 MB each for program and data); CPU 416F-3 PN/DP: 11.2 MB working memory (of which 5.6 MB each for program and data); faster working memory for sections of the user program that are significant for execution.
- Flexible expansion possibilities:  
Max. 262144 digital, 16384 analog inputs/outputs.
- MPI multi-point interface:  
The MPI allows a simple network to be established with up to 32 stations and a data transmission rate of up to 12 Mbit/s. The CPUs can establish up to 44 connections to stations of the communications bus (C bus) and MPI.
- Mode selector:  
Implemented as a toggle switch.
- Diagnostics buffer:  
The last 120 error and interrupt events are stored in a ring buffer for diagnostic purposes. The number of entries can be parameterized.
- Real-time clock:  
Diagnostic alarms of the CPU are tagged with the date and time.
- Memory card:  
To expand the integrated load memory. RAM and FEPRAM cards (FEPRAM for saving even at zero voltage).
- Combined MPI/DP interface and integrated PROFIBUS DP interface (with CPU 416F-2):  
The PROFIBUS DP master interface allows a distributed automation configuration offering high speed and ease of use. The distributed I/O is treated like a central I/O from the point of view of the user (same configuring, addressing and programming). Mixed installation: SIMATIC S5 and SIMATIC S7 as PROFIBUS master acc. to EN 50170.

CPU 416F-3 PN/DP also features:

- Submodule socket:  
Using the IF 964-DP interface module, an additional PROFIBUS DP master system can be connected.
- PROFINET interface with 2 ports (switch)
  - PROFINET I/O, 256 IO devices can be connected
  - PROFINET CBA

Fail-safe I/O modules can be connected to all integrated interfaces, to IF 964-DP and/or through communication modules (CP443-5 Ext. and CP443-1 Advanced). Safety-related communication is performed over PROFIBUS DP with the *PROFIsafe* profile.

#### Function

- Block protection:  
A password concept protects the user program from unauthorized access.
- Integrated HMI services:  
For HMI devices, the user only has to specify the source and destination for the data. They are then cyclically transported by the system automatically.
- Integrated communication functions:
  - PG/OP communication
  - Global data communication
  - S7 basic communication
  - S7 communication
- Firmware update over the network

# Fail-safe automation with SIMATIC

## CPUs for factory automation

CPU 416F

CPU 416-3 PN/DP additionally:

- Open communication over TCP/IP, UDP and ISO-on-TCP (RFC1006)
- Distributed intelligence in Component Based Automation (CBA) on PROFINET
- Additional diagnostic option with integrated web server

### Parameterizable properties

Using the STEP 7 hardware configuration tool, properties and responses of the S7-400 including the CPUs can be parameterized, e.g.:

- MPI multi-point interface:
  - Determining station addresses.
  - Start-up/cyclic response.
  - Determining the maximum cycle time and communication load.
- Address assignment: Addressing the I/O modules.
- Retentive areas: Determining the number of retentive bit memories, counters, timers, data blocks and clock bit memories
- Size of the process image, local data.
- Length of the diagnostic buffer.
- Protection level: Specifying the access rights to program and data.
- System diagnostics: Determining handling and scope of the diagnostic alarms.
- Cyclic interrupts: Setting of periodicity

CPU 416F-3 PN/DP additionally:

- PROFINET interface
- Parameterization of time synchronization with NTP procedure

### Information and display functions

- Status and error LEDs: LEDs indicate, for example, internal and external errors and operating states such as RUN, STOP, start-up and test functions.
- Test functions: The PG is used to indicate signal states during program execution, to modify process variables independently of the user program, to output the contents of stack memories, to execute individual program steps, and to block program sections.
- Information functions: The PG can be used to obtain information about the memory capacity and operating mode of the CPU and the current loading of the work and load memory.

### Communication

The safety related and standard communication between the central controller and the fail-safe ET 200 modules takes place over PROFIBUS DP and/or PROFINET. The specially developed PROFIBUS profile *PROFIsafe* supports the transfer of user data for the safety functions within the standard data message frame. Additional hardware components, e.g. special safety buses are not required. The necessary software is either integrated in the hardware components as an expansion of the operating system or loaded into the CPU later as a certified software block.

### Mode of operation

The safety functions of the F-CPU are included in the F program of the CPU and in the fail-safe signal modules.

The signal modules monitor the output and input signals by means of discrepancy analysis and the injection of test signals.

The CPU checks the proper operation of the controller by means of periodic self-tests, command tests and logic-based and time-

based program execution checks. Furthermore, the I/O is checked using requests for signs of life.

If an error is diagnosed in the system, the system will be placed in a safe state.

An F runtime license is not required to operate the CPU 416F-2 and CPU416F-3 PN/DP.

### Programming

The CPU 416F-2 and the CPU416F-3 PN/DP are programmed in the same manner as the other SIMATIC S7 systems. The user program for non-fail-safe plant sections is created using familiar programming tools, e.g. STEP 7.

### SIMATIC S7 Distributed Safety option package

The STEP 7 option package "SIMATIC S7 Distributed Safety" is required for programming the safety-related program components. The package contains all the functions and blocks required to create an F program.

The F program with the safety functions is connected in F FBD or F LAD or using special functions from the F library. Use of F FBD or F LAD simplifies configuration and programming of the plant and also acceptance testing thanks to the non-plant-specific uniform presentation form. The programmer can concentrate on configuration of the safety-related application without the need to use additional tools.

### Technical specifications

Order No.	6ES7 416-2FN05-0AB0	6ES7 416-3FS06-0AB0
<b>Product type designation</b>	<b>CPU 416F-2</b>	<b>CPU 416F-3 PN/DP</b>
Hardware product version		01
Firmware version		V6.0
associated programming package		STEP7 V5.5 or higher/iMap V3.0 + iMap STEP7 Add-on V3.0 SP5 or higher
<b>CiR - Configuration in RUN</b>		
CiR synchronization time, basic load	100 ms	100 ms
CiR synchronization time, time per I/O slave • 24 V DC	40 µs	10 µs; time per I/O byte No; power supply via system power supply
from backplane bus 5 V DC, max.	1.1 A	1.5 A
from interface 5 V DC, max.	90 mA; at each DP interface	90 mA; at each DP interface
<b>Power losses</b>		
Power loss, typ.	4 W	6.5 W
Power loss, max.		7.5 W
<b>Memory</b>		
Work memory		
• integrated	5.6 Mbyte	16 Mbyte
• integrated (for program)	2.8 Mbyte	8 Mbyte
• integrated (for data)	2.8 Mbyte	8 Mbyte
• expandable	No	No
Load memory		
• expandable FEPR0M	Yes	Yes; with Memory Card (FLASH)
• expandable FEPR0M, max.	64 Mbyte	64 Mbyte
• integrated RAM, max.	1 Mbyte	1 Mbyte
• expandable RAM	Yes	Yes; with Memory Card (RAM)

# Fail-safe automation with SIMATIC

## CPUs for factory automation

### CPU 416F

Order No.	6ES7 416-2FN05-0AB0	6ES7 416-3FS06-0AB0
• expandable RAM, max.	64 Mbyte	64 Mbyte
Backup		
• present	Yes	Yes
• with battery	Yes	Yes; All data
• without battery	No	No
<b>CPU-blocks</b>		
DB		
• Number, max.	10 000; Number range: 1 to 16,000	10 000; Number range: 1 to 16,000
• Size, max.	64 Kbyte	64 Kbyte
FB		
• Number, max.	5 000; Number range: 0 to 7999	5 000; Number range: 0 to 7999
• Size, max.	64 Kbyte	64 Kbyte
FC		
• Number, max.	5 000; Number range: 0 to 7999	5 000; Number range: 0 to 7999
• Size, max.	64 Kbyte	64 Kbyte
OB		
• Size, max.	64 Kbyte	64 Kbyte
Nesting depth		
• per priority class	24	24
• additional within an error OB	2	2
<b>CPU processing times</b>		
for bit operations, min.	30 ns	30 ns
for word operations, min.	30 ns	30 ns
for fixed point arithmetic, min.	30 ns	30 ns
for floating point arithmetic, min.	90 ns	90 ns
<b>Counters, timers and their retentivity</b>		
S7 counter		
• Number	2 048	2 048
• Retentivity		
- can be set	Yes	Yes
- lower limit	0	0
- upper limit	2 047	2 047
- preset	Z 0 to Z 7	Z 0 to Z 7
• Counting range		
- lower limit	0	0
- upper limit	999	999
IEC counter		
• present	Yes	Yes
• Type	SFB	SFB
• Number		Unlimited (limited only by RAM capacity)
S7 times		
• Number	2 048	2 048
• Retentivity		
- can be set	Yes	Yes
- lower limit	0	0
- upper limit	2 047	2 047
- preset	No times retentive	No times retentive
• Time range		
- lower limit	10 ms	10 ms
- upper limit	9 990 s	9 990 s
IEC timer		
• present	Yes	Yes
• Type	SFB	SFB

Order No.	6ES7 416-2FN05-0AB0	6ES7 416-3FS06-0AB0
• Number		Unlimited (limited only by RAM capacity)
<b>Data areas and their retentivity</b>		
retentive data area, total	Total working and load memory (with backup battery)	Total working and load memory (with backup battery)
Flag		
• Number, max.	16 Kbyte	16 Kbyte; Size of bit memory address area
• Retentivity available	Yes	Yes
• Retentivity preset	MB 0 to MB 15	MB 0 to MB 15
• Number of clock memories	8; (in 1 memory byte)	8; (in 1 memory byte)
Local data		
• adjustable, max.	32 Kbyte	32 Kbyte
• preset	16 Kbyte	16 Kbyte
<b>Address area</b>		
I/O address area		
• overall	16 Kbyte	16 Kbyte
• Outputs	16 Kbyte	16 Kbyte
• of which, distributed		
- MPI/DP interface, inputs	2 Kbyte	2 Kbyte
- MPI/DP interface, outputs	2 Kbyte	2 Kbyte
- DP interface, inputs	8 Kbyte	8 Kbyte
- DP interface, outputs	8 Kbyte	8 Kbyte
- PN interface, inputs		8 Kbyte
- PN interface, outputs		8 Kbyte
Process image		
• Inputs, adjustable	16 Kbyte	16 Kbyte
• Outputs, adjustable	16 Kbyte	16 Kbyte
• Inputs, default	512 byte	512 byte
• Outputs, default	512 byte	512 byte
• consistent data, max.	244 byte	244 byte
• Access to consistent data in process image	Yes	Yes
Subprocess images		
• Number of subprocess images, max.	15	15
Digital channels		
• Inputs	131 072	131 072
• Outputs	131 072	131 072
• Inputs, of which central	131 072	131 072
• Outputs, of which central	131 072	131 072
Analog channels		
• Inputs	8 192	8 192
• Outputs	8 192	8 192
• Inputs, of which central	8 192	8 192
• Outputs, of which central	8 192	8 192
<b>Hardware configuration</b>		
Expansion devices, max.	21	21
Multicomputing	Yes; 4 CPUs max. (with UR1 or UR2)	Yes; 4 CPUs max. (with UR1 or UR2)
Interface modules		
• Number of connectable IMs (total), max.	6	6

# Fail-safe automation with SIMATIC

## CPUs for factory automation

### CPU 416F

Order No.	6ES7 416-2FN05-0A00	6ES7 416-3FS06-0A00
• Number of connectable IM 460s, max.	6	6
• Number of connectable IM 463s, max.	4; IM 463-2	4; IM 463-2
Number of DP masters		
• integrated	2	1
• via IM 467	4	4
• via CP	10; CP 443-5 Extended	10; CP 443-5 Extended
• Mixed mode IM + CP permitted	No; IM 467 cannot be used with CP 443-5 Ext.; IM 467 cannot be used with CP 443-1 EX40 in PN IO mode	No; IM 467 not suitable for use with CP 443-5 Ext. and CP443-1 EX4x, EX20, GX20 (in PNIO mode)
• via interface module	0	1; IF 964-DP
• Number of pluggable S5 modules (via adapter capsule in central device), max.	6	6
Number of IO Controllers		
• integrated		1
• via CP	4; Via CP 443-1 EX 41 in PN mode; max. 4 in central controller	4; No mixed operation of CP443-1 EX40 and CP443-1 EX 41/EX20/GX20, max. 4 in central controller
Number of operable FMs and CPs (recommended)		
• FM	Limited by number of slots and number of connections	Limited by number of slots or number of connections
• CP, point-to-point	Limited by number of slots and number of connections	CP 440: Limited by number of slots; CP 441: Limited by number of slots and number of connections
• PROFIBUS and Ethernet CPs	14; Of which 10 CP or IM max. as DP master and PN controller	14; In total max. 10 CPs as DP master and PN controller, of which up to 10 IMs or CPs as DP master and up to 4 CPs as PN controller
<b>Time of day</b>		
Clock		
• Hardware clock (real-time clock)	Yes	Yes
• battery-backed and synchronizable	Yes	Yes
• Resolution	1 ms	1 ms
• Deviation per day (buffered), max.	1.7 s; Power off	1.7 s; Power off
• Deviation per day (unbuffered) max.	8.6 s; for power On	8.6 s; for power On
Runtime meter		
• Number	8	16
• Number/Number range	0 to 7	0 to 15
• Range of values	0 to 32767 hours	SFCs 2, 3 and 4: 0 to 32767 hours SFC 101: 0 to $2^{31}$ - 1 hours
• Granularity	1 hour	1 hour
• retentive	Yes	Yes
Clock synchronization		
• supported	Yes	Yes
• to MPI, master	Yes	Yes

Order No.	6ES7 416-2FN05-0A00	6ES7 416-3FS06-0A00
• to MPI, slave	Yes	Yes
• to DP, master	Yes	Yes
• to DP, slave	Yes	Yes
• in AS, master	Yes	Yes
• in AS, slave	Yes	Yes
• on Ethernet via NTP	Via CP	Yes; as client
• to IF 964 DP		Yes
<b>Interfaces</b>		
Number of USB interfaces		0
<b>1st interface</b>		
Type of interface	Integrated	Integrated
Physics	RS 485 / PROFIBUS	RS 485 / PROFIBUS + MPI
Isolated	Yes	Yes
Power supply to interface (15 to 30 V DC), max.	150 mA	150 mA
Number of connection resources	MPI: 44, DP: 32	MPI: 44, DP: 32
Functionality		
• MPI	Yes	Yes
• DP master	Yes	Yes
• DP slave	Yes	Yes
MPI		
• Number of connections	44	44; if a diagnostic repeater is used on the line, the number of connection resources on the line is reduced by 1
• Services		
- PG/OP communication	Yes	Yes
- Routing	Yes	Yes
- Global data communication	Yes	Yes
- S7 basic communication	Yes	Yes
- S7 communication	Yes	Yes
- S7 communication, as client		Yes
- S7 communication, as server		Yes
• Transmission rate, max.	12 Mbit/s	12 Mbit/s
DP master		
• Number of connections, max.	32	32; if a diagnostic repeater is used on the line, the number of connection resources on the line is reduced by 1
• Services		
- PG/OP communication	Yes	Yes
- Global data communication	No	No
- S7 basic communication	Yes	Yes
- S7 communication	Yes	Yes
- S7 communication, as client		Yes
- S7 communication, as server		Yes
- Equidistance mode support	Yes	Yes
- Isochronous mode		Yes
- SYNC/FREEZE	Yes	Yes

# Fail-safe automation with SIMATIC

## CPUs for factory automation

### CPU 416F

Order No.	6ES7 416-2FN05-0A00	6ES7 416-3FS06-0A00
- Activation/deactivation of DP slaves	Yes	Yes
- Direct data exchange (slave-to-slave communication)	Yes	Yes
- DPV1		Yes
• Transmission rate, max.	12 Mbit/s	12 Mbit/s
• Number of DP slaves, max.	32	32
• Address area		
- Inputs, max.	2 Kbyte	2 Kbyte
- Outputs, max.	2 Kbyte	2 Kbyte
• User data per DP slave		
- User data per DP slave, max.	244 byte	244 byte
- Inputs, max.	244 byte	244 byte
- Outputs, max.	244 byte	244 byte
- Slots, max.	244	244
- per slot, max.	128 byte	128 byte
DP slave		
• Number of connections	32	32
• Services		
- PG/OP communication	Yes	Yes; with interface active
- S7 routing		Yes; With interface active
- Global data communication		No
- S7 basic communication		No
- S7 communication		Yes
- S7 communication, as client		Yes
- S7 communication, as server		Yes
- Direct data exchange (slave-to-slave communication)		No
- DPV1		No
• GSD file	<a href="http://support.automation.siemens.com/WWW/view/com/113652">http://support.automation.siemens.com/WWW/view/com/113652</a>	
• Transmission rate, max.	12 Mbit/s	12 Mbit/s
• Automatic baud rate search		No
• Transfer memory		
- Inputs	244 byte	244 byte
- Outputs	244 byte	244 byte
• Address area, max.	32	32; Virtual slots
• User data per address area, max.	32 byte	32 byte
• User data per address area, of which consistent, max.	32 byte	32 byte
<b>2nd interface</b>		
Type of interface	Integrated	PROFINET
Physics	RS 485 / PROFIBUS	Ethernet RJ45
Isolated	Yes	Yes
Integrated switch		Yes
Number of ports		2
Power supply to interface (15 to 30 V DC), max.	150 mA	

Order No.	6ES7 416-2FN05-0A00	6ES7 416-3FS06-0A00
automatic detection of transmission speed		Yes; Autosensing
Autonegotiation		Yes
Autocrossing		Yes
Media redundancy		
• supported		Yes
• Switchover time on line break, typically		200 ms
• Number of stations in the ring, max.		50
Change of IP address at runtime, supported		Yes; Assignment by higher-level IO Controller or by the user program with SFB104 "IP_CONF"
Number of connection resources	32	96
Functionality		
• DP master	Yes	No
• DP slave	Yes	No
• PROFINET IO Controller		Yes
• PROFINET IO Device		Yes
• PROFINET CBA		Yes
• Local Operating Network		No
DP master		
• Number of connections, max.	32	
• Services		
- PG/OP communication	Yes	
- Global data communication	No	
- S7 basic communication	Yes	
- S7 communication	Yes	
- Equidistance mode support	Yes	
- SYNC/FREEZE	Yes	
- Activation/deactivation of DP slaves	Yes	
- Direct data exchange (slave-to-slave communication)	Yes	
• Transmission rate	max. 12 Mbit/s	
• Number of DP slaves, max.	125	
• Address area		
- Inputs, max.	8 Kbyte	
- Outputs, max.	8 Kbyte	
• User data per DP slave		
- User data per DP slave, max.	244 byte	
- Inputs, max.	244 byte	
- Outputs, max.	244 byte	
- Slots, max.	244	
- per slot, max.	128 byte	
DP slave		
• No. of connections	32	
• Services		
• GSD file	<a href="http://support.automation.siemens.com/WWW/view/com/113652">http://support.automation.siemens.com/WWW/view/com/113652</a>	
• Transmission rate	max. 12 Mbit/s	

# Fail-safe automation with SIMATIC

## CPUs for factory automation

### CPU 416F

Order No.	6ES7 416-2FN05-0AB0	6ES7 416-3FS06-0AB0
<ul style="list-style-type: none"> <li>Transfer memory               <ul style="list-style-type: none"> <li>- Inputs 244 byte</li> <li>- Outputs 244 byte</li> </ul> </li> <li>Address area, max. 32</li> <li>User data per address area, max. 32 byte</li> <li>User data per address area, of which consistent, max. 32 byte</li> </ul>		
PROFINET IO Controller		
<ul style="list-style-type: none"> <li>Services               <ul style="list-style-type: none"> <li>- PG/OP communication Yes</li> <li>- S7 routing Yes</li> <li>- S7 communication Yes</li> <li>- Isochronous mode Yes; only with IRT and the High Performance option</li> <li>- Open IE communication Yes</li> </ul> </li> <li>Transmission rate max. 100 Mbit/s</li> <li>Number of connectable IO devices, max. 256</li> <li>Max. number of connectable IO devices for RT 256               <ul style="list-style-type: none"> <li>- of which in line max. 256</li> </ul> </li> <li>Number of IO Devices with IRT and the option "high flexibility" 256               <ul style="list-style-type: none"> <li>- of which in line, max. 61</li> </ul> </li> <li>Number of IO Devices with IRT and the option "high performance" max. 64               <ul style="list-style-type: none"> <li>- of which in line, max. 64</li> </ul> </li> <li>IRT, supported Yes</li> <li>Shared device, supported Yes               <ul style="list-style-type: none"> <li>- Number of IO Devices, max. 32</li> </ul> </li> <li>Activation/deactivation of IO Devices Yes               <ul style="list-style-type: none"> <li>- Number of IO Devices that can be simultaneously activated/deactivated, max. 8</li> </ul> </li> <li>IO Devices changing during operation (partner ports), supported Yes               <ul style="list-style-type: none"> <li>- Max. number of IO devices per tool 8; 8 parallel calls of the SFC 12 "D_ACT_DP" possible per line. Max. 32 IO Devices changing during operation (partner ports) are supported.</li> </ul> </li> <li>Device replacement without swap medium Yes</li> <li>Send clock times 250 µs, 500 µs, 1 ms, 2 ms, 4 ms additionally with IRT with high performance: 250 µs to 4 ms in 125 µs frame</li> </ul>		

Order No.	6ES7 416-2FN05-0AB0	6ES7 416-3FS06-0AB0
<ul style="list-style-type: none"> <li>Updating time 250 µs to 512 ms; min. value depends on preset communication share for PROFINET IO, on the number of IO Devices and on the amount of configured user data</li> <li>Address area               <ul style="list-style-type: none"> <li>- Inputs, max. 8 Kbyte</li> <li>- Outputs, max. 8 Kbyte</li> </ul> </li> <li>User data per address area, max. 1 024 byte               <ul style="list-style-type: none"> <li>- User data consistency, max.</li> </ul> </li> </ul>		
PROFINET IO device		
<ul style="list-style-type: none"> <li>Services               <ul style="list-style-type: none"> <li>- PG/OP communication Yes</li> <li>- S7 routing Yes</li> <li>- S7 communication Yes</li> <li>- Isochronous mode No</li> <li>- Open IE communication Yes</li> <li>- IRT, supported Yes</li> <li>- Prioritized startup supported Yes</li> <li>- Shared device, supported Yes</li> <li>- Number of IO controllers with shared device, max. 2</li> </ul> </li> <li>Transfer memory               <ul style="list-style-type: none"> <li>- Inputs, max. 1 440 byte; Per IO Controller with shared device</li> <li>- Outputs, max. 1 440 byte; Per IO Controller with shared device</li> </ul> </li> <li>Submodules               <ul style="list-style-type: none"> <li>- Number, max. 64</li> <li>- User data per submodule, max. 1 024 byte</li> </ul> </li> <li>Open IE communication, supported Yes</li> <li>Keep-alive function, supported Yes</li> </ul>		
<b>3rd interface</b>		
Type of interface		Pluggable interface module (IF)
Plug-in interface modules		IF 964-DP (MLFB: 6ES7964-2AA04-0AB0)
Physics		RS 485 / PROFIBUS
Isolated		Yes
Power supply to interface (15 to 30 V DC), max.		150 mA

# Fail-safe automation with SIMATIC

## CPUs for factory automation

### CPU 416F

Order No.	6ES7 416-2FN05-0AB0	6ES7 416-3FS06-0AB0
Automatic detection of transmission speed		No
Number of connection resources		32
Functionality		
• MPI		No
• DP master		Yes
• DP slave		Yes
DP master		
• Number of connections, max.		32
• Services		
- PG/OP communication		Yes
- Global data communication		No
- S7 basic communication		Yes
- S7 communication		Yes
- S7 communication, as client		Yes
- S7 communication, as server		Yes
- Equidistance mode support		Yes
- Isochronous mode		Yes
- SYNC/FREEZE		Yes
- Activation/deactivation of DP slaves		Yes
- Direct data exchange (slave-to-slave communication)		Yes
- DPV1		Yes
• Transmission rate, max.		12 Mbit/s
• Number of DP slaves, max.		125
• Address area		
- Inputs, max.		8 Kbyte
- Outputs, max.		8 Kbyte
• User data per DP slave		
- User data per DP slave, max.		244 byte
- Inputs, max.		244 byte
- Outputs, max.		244 byte
- Slots, max.		244
- per slot, max.		128 byte
DP slave		
• Number of connections		32
• Services		
- PG/OP communication		Yes
- S7 routing		Yes; With active interface
- Global data communication		No
- S7 basic communication		No
- S7 communication		Yes
- S7 communication, as client		Yes
- S7 communication, as server		Yes
- Direct data exchange (slave-to-slave communication)		No
- DPV1		No

Order No.	6ES7 416-2FN05-0AB0	6ES7 416-3FS06-0AB0
• GSD file		<a href="http://support.automation.siemens.com/WWW/view/com/113652">http://support.automation.siemens.com/WWW/view/com/113652</a>
• Transmission rate, max.		12 Mbit/s
• Automatic baud rate search		No
• Transfer memory		
- Inputs		244 byte
- Outputs		244 byte
• Address areas, max.		32; Virtual slots
• User data per address area, max.		32 byte
• User data per address area, of which consistent, max.		32 byte
<b>Communication functions</b>		
PG/OP communication	Yes	Yes
• Number of connectable OPs without message processing	63	95
• Number of connectable OPs with message processing	63; When using alarm_S and alarm_D	95; When using Alarm_S/SQ and Alarm_D/DQ
Global data communication		
• supported	Yes	Yes
• Number of GD packets, transmitter, max.	16	16
• Number of GD packets, receiver, max.	32	32
• Size of GD packets, max.	54 byte	54 byte
• Size of GD packet (of which consistent), max.	1 variable	1 variable
S7 basic communication		
• supported	Yes	Yes
• User data per job, max.	76 byte	76 byte
• User data per job (of which consistent), max.	1 variable	1 variable
S7 communication		
• supported	Yes	Yes
• as server		Yes
• as client		Yes
• User data per job, max.	64 Kbyte	64 Kbyte
• User data per job (of which consistent), max.	462 byte; 1 variable	462 byte; 1 variable
S5-compatible communication		
• supported	Yes; (via CP max. 10 and FC AG_SEND and FC AG_RECV)	Yes; Via FC AG_SEND and AG_RECV, max. via 10 CP 443-1 or 443-5
• User data per job, max.	8 Kbyte	8 Kbyte
• User data per job (of which consistent), max.	240 byte	240 byte



# Fail-safe automation with SIMATIC

## CPUs for factory automation

### CPU 416F

Order No.	6ES7 416-2FN05-0A00	6ES7 416-3FS06-0A00
• Number of simultaneous AG-SEND/AG-RECV orders per CPU, max.	64/64	64/64
Standard communication (FMS) • supported	Yes; Via CP and loadable FB	Yes; Via CP and loadable FB
Open IE communication • TCP/IP		Yes; Via integrated PROFINET interface and loadable FBs 94
- Number of connections, max.		32 Kbyte
- Data length, max.		Yes
- Several passive connections per port, supported		
• ISO-on-TCP (RFC1006)	Via CP 443-1 Adv. and loadable FB	Yes; Via integrated PROFINET interface or CP 443-1 and loadable FBs 94
- Number of connections, max.		32 Kbyte; 1452 bytes via CP 443-1 Adv.
- Data length, max.	1452	Yes; Via integrated PROFINET interface and loadable FBs 94
• UDP		1 472 byte
- Number of connections, max.		Yes
- Data length, max.	No; Via CP	5
• supported		Yes
• Number of HTTP clients		
• User-defined websites		
PROFINET CBA (at setpoint communication load)		
• Setpoint for the CPU communication load		20 %
• Number of remote interconnection partners		32
• Number of functions, master/slave		150
• Total of all Master/Slave connections		6 000
• Data length of all incoming connections master/slave, max.		65 000 byte
• Data length of all outgoing connections master/slave, max.		65 000 byte
• Number of device-internal and PROFIBUS interconnections		1 000
• Data length of device-internal und PROFIBUS interconnections, max.		16 000 byte
• Data length per connection, max.		2 000 byte
• Remote interconnections with acyclic transmission		

Order No.	6ES7 416-2FN05-0A00	6ES7 416-3FS06-0A00
- Sampling frequency: Sampling time, min.		200 ms; Depending on preset communication load, number of interconnections and data length used 500
- Number of incoming interconnections		500
- Number of outgoing interconnections		16 000 byte
- Data length of all incoming interconnections, max.		16 000 byte
- Data length of all outgoing interconnections, max.		2 000 byte
- Data length per connection, max.		
• Remote interconnections with cyclic transmission		1 ms; Depending on preset communication load, number of interconnections and data length used 300
- Transmission frequency: Transmission interval, min.		
- Number of incoming interconnections		300
- Number of outgoing interconnections		4 800 byte
- Data length of all incoming interconnections, max.		4 800 byte
- Data length of all outgoing interconnections, max.		450 byte
- Data length per connection, max.		
• HMI variables via PROFINET (acyclic)		2x PN OPC/1x iMap
- Number of stations that can log on for HMI variables (PN OPC/iMap)		500 ms
- HMI variable updating		1 500
- Number of HMI variables		48 000 byte
- Data length of all HMI variables, max.		
• PROFIBUS proxy functionality		Yes; 32 PROFIBUS slaves max. connectable 240 byte; Slave-dependent
- supported		
- Data length per connection, max.		
Number of connections		
• overall	64	96
<b>S7 message functions</b>		
Number of login stations for message functions, max.	63; Max. 63 with ALARM_S and ALARM_D (OPs); max. 12 with ALARM_8 and ALARM_P (e.g. WinCC)	95; Max. 95 with Alarm_S/SQ and Alarm_D/DQ (OPs); max. 8 with Alarm, Alarm_8, Alarm_8P, Notify and Notify_8 (e.g. WinCC)
Symbol-related messages	Yes	Yes
SCAN procedure		Yes
Number of messages		
• overall, max.	1 024	1 024
Block related messages	Yes	Yes

# Fail-safe automation with SIMATIC

## CPUs for factory automation

### CPU 416F

Order No.	6ES7 416-2FN05-0AB0	6ES7 416-3FS06-0AB0
Process diagnostic messages		Yes
simultaneously active Alarm-S blocks, max.	200	1 000; simultaneously active alarm_S/SQ blocks or alarm_D/DQ blocks
Alarm 8-blocks	Yes	Yes
• Number of instances for alarm 8 and S7 communication blocks, max.	1 800	4 000
• preset, max.	600	600
Process control messages	Yes	Yes
<b>Test commissioning functions</b>		
Status/control		
• Status/control variable	Yes	Yes; Up to 16 variable tables
• Variables	Inputs/outputs, memory bits, DB, distributed I/Os, timers, counters	Inputs/outputs, memory bits, DB, distributed I/Os, timers, counters
• Number of variables, max.	70	70; Status/control
Forcing		
• Forcing	Yes	Yes
• Force, variables	Inputs/outputs, bit memories, distributed I/Os	Inputs/outputs, bit memories, distributed I/Os
• Number of variables, max.	512	512
Status block	Yes	Yes; up to 16 simultaneously
Single step	Yes	Yes
Number of breakpoints	4	16
Diagnostic buffer		
• present	Yes	Yes
• Number of entries, max.	3 200	3 200
- can be set	Yes	Yes
- preset	120	120
<b>Isochronous mode</b>		
Isochronous mode	Yes	Yes; via PROFIBUS DP or PROFINET interface
Number of DP masters with isochronous mode		2
User data per isochronous slave, max.	244 byte	244 byte
equidistance	Yes	Yes
shortest clock pulse	1 ms; 0.5 ms without use of SFC 126, 127	1 ms; 0.5 ms without use of SFC 126, 127
max. cycle	32 ms	32 ms
<b>Standards, approvals, certificates</b>		
Configuration software		
• STEP 7	Yes	Yes
programming		
• Programming language		
- LAD	Yes	Yes
- FBD	Yes	Yes
- STL	Yes	Yes
- SCL	Yes	Yes
- CFC	Yes	Yes

Order No.	6ES7 416-2FN05-0AB0	6ES7 416-3FS06-0AB0
- GRAPH	Yes	Yes
- HiGraph®	Yes	Yes
• Command set	See instruction list	See instruction list
• Nesting levels	7	7
Know-how protection		
• User program protection/password protection	Yes	Yes
• Block encryption		Yes; with S7 block Privacy
<b>Dimensions and weight</b>		
Required slots	1	2
Dimensions		
• Width	25 mm	50 mm
• Height	290 mm	290 mm
• Depth	219 mm	219 mm
Weight		
• Weight, approx.	720 g	900 g

### Selection and ordering data

	Order No.
<b>CPU 416F-2</b>	<b>6ES7 416-2FN05-0AB0</b>
For configuring safety-related automation systems; 5.6 MB RAM, 24 V DC power supply, MPI/PROFIBUS DP master interface, PROFIBUS DP master interface, slot for memory card, incl. slot number labels	
<b>CPU 416F-3 PN/DP</b>	
For configuring safety-related automation systems; 24 V DC power supply, MPI/PROFIBUS DP master interface, PROFINET interface, PROFIBUS DP master interface, receptacle for 1 IF submodule, slot for memory card, incl. slot number labels	
11.2 MB RAM	<b>6ES7 416-3FR05-0AB0</b>
16 MB RAM	<b>6ES7 416-3FS06-0AB0</b>
<b>Option package S7 F Distributed Safety V5.4</b>	
for generating fail-safe programs for the S7-300F	
Floating license	<b>6ES7 833-1FC02-0YA5</b>
Upgrade from V5.x to V5.4	<b>6ES7 833-1FC02-0YE5</b>
Software Update Service	<b>6ES7 833-1FC00-0YX2</b>
<b>Memory card RAM</b>	
64 KB	<b>6ES7 952-0AF00-0AA0</b>
256 KB	<b>6ES7 952-1AH00-0AA0</b>
1 MB	<b>6ES7 952-1AK00-0AA0</b>
2 MB	<b>6ES7 952-1AL00-0AA0</b>
4 MB	<b>6ES7 952-1AM00-0AA0</b>
8 MB	<b>6ES7 952-1AP00-0AA0</b>
16 MB	<b>6ES7 952-1AS00-0AA0</b>
64 MB	<b>6ES7 952-1AY00-0AA0</b>
<b>FEPRM memory card</b>	
64 KB	<b>6ES7952-0KF00-0AA0</b>
256 KB	<b>6ES7952-0KH00-0AA0</b>

# Fail-safe automation with SIMATIC

## CPUs for factory automation

CPU 416F

	Order No.
1 MB	<b>6ES7 952-1KK00-0AA0</b>
2 MB	<b>6ES7 952-1KL00-0AA0</b>
4 MB	<b>6ES7 952-1KM00-0AA0</b>
8 MB	<b>6ES7 952-1KP00-0AA0</b>
16 MB	<b>6ES7 952-1KS00-0AA0</b>
32 MB	<b>6ES7 952-1KT00-0AA0</b>
64 MB	<b>6ES7 952-1KY00-0AA0</b>
<b>MPI cable</b> for connection of SIMATIC S7 and PG via MPI; 5 m in length	<b>6ES7 901-0BF00-0AA0</b>
<b>IF 964-DP interface module</b> For connecting an additional DP line	<b>6ES7 964-2AA04-0AB0</b>
<b>Slot number plates</b> 1 set (spare part)	<b>6ES7 912-0AA00-0AA0</b>
<b>Manual "SIMATIC S7-400 programmable controller"</b> incl. instruction list	
German	<b>6ES7 498-8AA05-8AA0</b>
English	<b>6ES7 498-8AA05-8BA0</b>
<b>S7-400 operation list</b>	
German	<b>6ES7 498-8AA05-8AN0</b>
English	<b>6ES7 498-8AA05-8BN0</b>
<b>Manual "Communication for SIMATIC S7-300/-400"</b>	
German	<b>6ES7 398-8EA00-8AA0</b>
English	<b>6ES7 398-8EA00-8BA0</b>
French	<b>6ES7 398-8EA00-8CA0</b>
Spanish	<b>6ES7 398-8EA00-8DA0</b>
Italian	<b>6ES7 398-8EA00-8EA0</b>
<b>SIMATIC Manual Collection</b> Electronic manuals on DVD, multilingual: LOGO!, SIMADYN, SIMATIC bus components, SIMATIC C7, SIMATIC distributed I/O, SIMATIC HMI, SIMATIC Sensors, SIMATIC NET, SIMATIC PC Based Automation, SIMATIC PCS 7, SIMATIC PG/PC, SIMATIC S7, SIMATIC Software, SIMATIC TDC	<b>6ES7 998-8XC01-8YE0</b>
<b>SIMATIC Manual Collection update service for 1 year</b> Current "Manual Collection" DVD and the three subsequent updates	<b>6ES7 998-8XC01-8YE2</b>
<b>Brochure "SIMATIC S7-400 programmable controller - Design and application"</b>	
German	<b>6ES7 498-8AA00-8AB0</b>
English	<b>6ES7 498-8AA00-8BB0</b>
<b>PROFIBUS bus components</b>	
<b>RS 485 bus connector with 90° cable outlet</b> Max. transfer rate 12 Mbit/s without PG interface With PG interface	<b>6ES7 972-0BA12-0XA0</b> <b>6ES7 972-0BB12-0XA0</b>

	Order No.
<b>RS 485 bus connector with angled cable outlet</b> Max. transfer rate 12 Mbit/s without PG interface With PG interface	<b>6ES7 972-0BA42-0XA0</b> <b>6ES7 972-0BB42-0XA0</b>
<b>RS 485 bus connector with 90° cable outlet for Fast Connect system</b> Max. transfer rate 12 Mbit/s without PG interface • 1 unit • 100 units with PG interface • 1 unit • 100 units	<b>6ES7 972-0BA52-0XA0</b> <b>6ES7 972-0BA52-0XB0</b> <b>6ES7 972-0BB52-0XA0</b> <b>6ES7 972-0BB52-0XB0</b>
<b>RS 485 bus connector with axial cable outlet</b> For SIMATIC OP, for connection to PPI, MPI, PROFIBUS	<b>6GK1 500-0EA02</b>
<b>PROFIBUS FastConnect bus cable</b> Standard type with special design for quick mounting, 2-core, shielded, sold by the meter, max. delivery unit 1000 m, minimum ordering quantity 20 m	<b>6XV1 830-0EH10</b>
<b>RS 485 repeater for PROFIBUS</b> Transfer rate up to 12 Mbit/s; 24 V DC; IP20 enclosure	<b>6ES7 972-0AA01-0XA0</b>
<b>PROFINET bus components</b>	
<b>IE FC TP standard cable GP 2x2</b> 4-core, shielded TP installation cable for connection to IE FC Outlet RJ45/IE FC RJ45 Plug; PROFINET-compatible; with UL approval; sold by the meter	<b>6XV1 840-2AH10</b>
<b>FO Standard Cable GP (50/125)</b> Standard cable, splittable, UL approval, sold by the meter	<b>6XV1 873-2A</b>
<b>SCALANCE X204-2 Industrial Ethernet Switch</b> Industrial Ethernet Switches with integral SNMP access, web diagnostics, copper cable diagnostics and PROFINET diagnostics for configuring line, star and ring topologies; four 10/100 Mbit/s RJ45 ports and two FO ports	<b>6GK5 204-2BB10-2AA3</b>
<b>IE FC RJ45 plugs</b> RJ45 plug connector for Indus- trial Ethernet with a rugged metal enclosure and integrated insulation displacement contacts for connecting Industrial Ethernet FC installation cables	
<b>IE FC RJ45 plug 180</b> 180° cable outlet 1 unit 10 units 50 units	<b>6GK1 901-1BB10-2AA0</b> <b>6GK1 901-1BB10-2AB0</b> <b>6GK1 901-1BB10-2AE0</b>
<b>PROFIBUS/PROFINET bus components</b>	<b>See Catalogs IK PI, CA 01</b>

3

# Fault-tolerant automation with SIMATIC

## CPUs for process automation

### Fault-tolerant CPUs

#### Overview

- 3 fault-tolerant CPUs (CPU 412-3H, CPU 414-4H, CPU 417-4H)
- Graded performance spectrum for a wide range of different applications

#### *SIPLUS versions*

All of the fault-tolerant CPUs for process automation are available as SIPLUS versions:

- SIPLUS CPU 412-3H
- SIPLUS CPU 414-4H
- SIPLUS CPU 417-4H

The SIPLUS versions are capable of coping with higher ambient temperatures and harsher environments. The SIPLUS versions are described together with the based-on modules.

Technical documentation for SIPLUS is available at:

<http://www.siemens.com/siplus-extreme>

### Overview



- CPU for the SIMATIC S7-400H and S7-400F/FH
- Can be used in S7-400H fault-tolerant systems
- Can be used with F runtime license as F-enabled CPU in S7-400F/FH safety-related systems
- With combined MPI/PROFIBUS DP master interface
- With 2 connection slots for synchronization modules

#### SIPLUS Version

A SIPLUS version of this module is also available.

SIPLUS CPU 412-3H	
Order No.	6AG1 412-3HJ14-4AB0
Order No. based on	6ES7 412-3HJ14-0AB0
Conformal coating	Coating material of circuit boards and of electronic circuitry in accordance with EN 60721
Technical data	The technical data are identical with those of the based-on module, except for the ambient conditions.
Permitted ambient temperature range	0 ... +60 °C
Permitted relative humidity	5 ... 100 %, condensation is allowed
Biologically active substances	Conformity with EN 60721-3-3, Class 3B2 mold and fungal spores (except fauna)
Chemically active substances	Conformity with EN 60721-3-3, Class 3C4 incl. salt mist and ISA-S71.04 severity level G1; G2; G3; GX <sup>1) 2)</sup>
Mechanically active substances	Conformity with EN 60721-3-3, Class 3S4 including conductive sand, dust <sup>2)</sup>
Air pressure (depending on the highest positive temperature range specified)	1080 ... 795 hPa (-1000 ... +2000 m) see ambient temperature range 795 ... 658 hPa (+2000 ... +3500 m), derating 10 K 658 ... 540 hPa (+3500 ... +5000 m), derating 20 K

- 1) ISA-S71.04 severity level GX: Long-term load: SO<sub>2</sub> < 4.8 ppm; H<sub>2</sub>S < 9.9 ppm; Cl < 0.2 ppm; HCl < 0.66 ppm; HF < 0.12 ppm; NH < 49 ppm; O<sub>3</sub> < 0.1 ppm; NO<sub>x</sub> < 5.2 ppm  
Limit value (max. 30 min/d): SO<sub>2</sub> < 17.8 ppm; H<sub>2</sub>S < 49.7 ppm; Cl < 1.0 ppm; HCl < 3.3 ppm; HF < 2.4 ppm; NH < 247 ppm; O<sub>3</sub> < 1.0 ppm; NO<sub>x</sub> < 10.4 ppm
- 2) The supplied plug covers must remain in place over the unused interface when operated in atmospheres containing corrosive gases!

Technical documentation for SIPLUS is available at:

<http://www.siemens.com/siplus-extreme>

### Application

The CPU 412-3H can be used for the SIMATIC S7-400H and S7-400F/FH. It enables the establishment of fault-tolerant S7-400H systems. It can also be used for the S7-400F/FH fail-safe automation system in conjunction with the F runtime license. The integrated PROFIBUS DP interface enables direct connection as master to the PROFIBUS DP fieldbus.

### Design

The CPU 412-3H features:

- A powerful processor:  
The CPU achieves command runtimes as low as 75 ns per binary command.
- 768 KB RAM (512 KB for program, 256 KB for data); Load memory for user programs and parameterization data of the S7-400H F/FH automation system; high-speed RAM for sequence-relevant sections of the user program
- A memory card:  
For expanding the integrated load memory. The load memory contains the parameterization data of the S7-400H F/FH as well as the program, and therefore requires approximately double the memory space. The result is that the integrated load memory is not sufficient for large programs, which is why the memory card is often required. RAM and EPROM cards are available (EPROM for saving at zero voltage too).
- Easy expandability:  
Max. 65K digital and 4K analog inputs/outputs.
- Combined MPI/PROFIBUS DP interface:  
The MPI enables the creation of a simple network with max. 32 nodes and a data transfer rate of 187.5 Kbit/s. The CPU can establish up to 64 connections to nodes on the communication bus (C bus) and the MPI. The PROFIBUS DP master interface enables a distributed automation configuration with high speed and simple handling. From the user's point of view, the distributed I/Os are treated like centralized I/Os (same configuration, addressing and programming).
- Mode selector:  
Designed as a toggle switch.
- Diagnostics buffer:  
The last 120 alarm and interrupt events are stored in a ring buffer for diagnostics purposes.
- Real-time clock:  
Diagnostics messages from the CPU are provided with the date and time of day.

### Function

- Block protection:  
In addition to the keylock switch, a password concept protects the user program from unauthorized access.
- Integrated HMI services:  
In the case of HMI devices, the user only has to specify the source and destination of the data. These are automatically transferred cyclically by the system.
- Integral communications functions:  
- PG/OP communication  
- Extended communication (simple and fault-tolerant)

#### Parameterizable properties

With the STEP 7 tool "Hardware Configuration" and the installed option package S7-400H, the properties and behavior of the S7-400H including the CPUs can be parameterized, e.g.:

- Multipoint-capable MPI interface:  
- Determination of node addresses.  
- Startup/cyclic behavior.  
- Definition of maximum cycle time and communication load.

# Fault-tolerant automation with SIMATIC

## CPUs for process automation

### CPU 412-3H

- Address assignment:  
Addressing of the I/O modules.
- Retentive areas:  
Definition of the number of retentive bit memories, counters, timers, data blocks and clock memories.
- Protection level:  
Definition of access authorization to program and data.
- System diagnostics:  
Determination of handling and scope of diagnostics messages.
- Watchdog interrupts:  
Setting periodicity.
- Configuring of H stations.

#### Safety-related functions

With the F runtime license, the safety-related F user program can be compiled and run on the CPU. One license is required for each S7-400F/FH system. The scope of supply includes 2 TÜV (German technical inspectorate) stickers.

#### Display and information functions

- Status and fault indicators:  
LEDs indicate, for example, internal and external faults and operating statuses such as RUN, STOP, startup, "Master" operating mode, redundancy errors, and test function.
- Test functions:  
The programming device can be used to display signal states in the program execution sequence, modify process variables independently of the user program, output contents of stack memories, run through program steps individually, and disable program sections.
- Information functions:  
The user can obtain information about the memory capacity and operating mode of the CPU, and the current utilization of the RAM and load memory.

#### Technical specifications

Order No.	6ES7 412-3HJ14-0AB0
<b>Product version</b>	
Hardware product version	1
Firmware version	V4.5
associated programming package	STEP7 V 5.3 SP2 or higher with HW update
<b>Supply voltages</b>	
Rated value	
• 24 V DC	No; Power supply via system power supply
Feeding of external backup voltage to CPU	5 to 15 VDC
<b>Current consumption</b>	
from backplane bus 5 V DC, max.	1.5 A
from interface 5 V DC, max.	90 mA; At each DP interface
<b>Power losses</b>	
Power loss, typ.	5.5 W
<b>Backup battery</b>	
Battery operation	
• Backup current, typ.	190 µA; Valid up to 40°C
• Backup current, max.	660 µA
<b>Memory</b>	
Work memory	
• integrated (for program)	512 Kbyte
• integrated (for data)	256 Kbyte
• expandable	No

Order No.	6ES7 412-3HJ14-0AB0
<b>Load memory</b>	
• expandable FEPRM	Yes
• expandable FEPRM, max.	64 Mbyte
• integrated RAM, max.	256 Kbyte
• expandable RAM	Yes
• expandable RAM, max.	64 Mbyte
<b>Backup</b>	
• present	Yes
• with battery	Yes; All data
• without battery	No
<b>CPU-blocks</b>	
<b>DB</b>	
• Number, max.	4 095; Number range: 1 to 4095
• Size, max.	64 Kbyte
<b>FB</b>	
• Number, max.	2 048; Number range: 0 to 2047
• Size, max.	64 Kbyte
<b>FC</b>	
• Number, max.	2 048; Number range: 0 to 2047
• Size, max.	64 Kbyte
<b>OB</b>	
• Size, max.	64 Kbyte
<b>Nesting depth</b>	
• per priority class	24
• additional within an error OB	1
<b>CPU processing times</b>	
for bit operations, min.	0.075 µs
for word operations, min.	0.075 µs
for fixed point arithmetic, min.	0.075 µs
for floating point arithmetic, min.	0.225 µs
<b>Counters, timers and their retentivity</b>	
<b>S7 counter</b>	
• Number	2 048
• Retentivity	
- can be set	Yes
- lower limit	0
- upper limit	2 047
- preset	Z 0 to Z 7
• Counting range	
- lower limit	0
- upper limit	999
<b>IEC counter</b>	
• present	Yes
• Type	SFB
<b>S7 times</b>	
• Number	2 048
• Retentivity	
- can be set	Yes
- lower limit	0
- upper limit	2 047
- preset	No times retentive
• Time range	
- lower limit	10 ms
- upper limit	9 990 s
<b>IEC timer</b>	
• present	Yes
• Type	SFB

# Fault-tolerant automation with SIMATIC

## CPUs for process automation

CPU 412-3H

Order No.	6ES7 412-3HJ14-0AB0
<b>Data areas and their retentivity</b>	
retentive data area, total	Total working and load memory (with backup battery)
Flag	
• Number, max.	8 Kbyte
• Retentivity available	Yes
• Number of clock memories	8; (in 1 memory byte)
Data blocks	
• Number, max.	4 095; Number range: 1 to 4095
• Size, max.	64 Kbyte
Local data	
• adjustable, max.	16 Kbyte
• preset	8 Kbyte
<b>Address area</b>	
I/O address area	
• overall	8 Kbyte
• Outputs	8 Kbyte
• of which, distributed	
- MPI/DP interface, inputs	2 Kbyte
- MPI/DP interface, outputs	2 Kbyte
Process image	
• Inputs, adjustable	8 Kbyte
• Outputs, adjustable	8 Kbyte
• Inputs, default	256 byte
• Outputs, default	256 byte
• consistent data, max.	244 byte
• Access to consistent data in process image	Yes
Subprocess images	
• Number of subprocess images, max.	15
Digital channels	
• Inputs	65 536
• Outputs	65 536
• Inputs, of which central	65 536
• Outputs, of which central	65 536
Analog channels	
• Inputs	4 096
• Outputs	4 096
• Inputs, of which central	4 096
• Outputs, of which central	4 096
<b>Hardware configuration</b>	
connectable OPs	15 without message processing, 8 with message processing
Central devices, max.	1
Expansion devices, max.	21
Multicomputing	No
Interface modules	
• Number of connectable IMs (total), max.	6
• Number of connectable IM 460s, max.	6
• Number of connectable IM 463s, max.	4; Single mode only
Number of DP masters	
• integrated	1
• via CP	10
• Mixed mode IM + CP permitted	No
• via interface module	0

Order No.	6ES7 412-3HJ14-0AB0
Number of operable FMs and CPs (recommended)	
• FM	See manual Automation System S7-400H fault-tolerant systems. Limited by number of slots and number of connections
• CP, point-to-point	See manual Automation System S7-400H fault-tolerant systems. Limited by number of slots and number of connections
• PROFIBUS and Ethernet CPs	14; of which max. 10 CP as DP master
<b>Time of day</b>	
Clock	
• Hardware clock (real-time clock)	Yes
• battery-backed and synchronizable	Yes
• Resolution	1 ms
Runtime meter	
• Number	8
Clock synchronization	
• supported	Yes
• to MPI, master	Yes
• to MPI, slave	Yes
• to DP, master	Yes
• to DP, slave	Yes
• in AS, master	Yes
• in AS, slave	Yes
<b>S7 message functions</b>	
Number of login stations for message functions, max.	8
Symbol-related messages	No
Block related messages	Yes
Alarm 8-blocks	Yes
Process control messages	Yes
<b>Test commissioning functions</b>	
Status/control	
• Status/control variable	Yes
Forcing	
• Forcing	Yes
Status block	Yes
Single step	Yes
Number of breakpoints	4
Diagnostic buffer	
• present	Yes
• Number of entries, max.	3 200
- can be set	Yes
- preset	120
<b>Communication functions</b>	
PG/OP communication	Yes
Routing	Yes
Global data communication	
• supported	No
S7 basic communication	
• supported	No
S7 communication	
• supported	Yes
• as server	Yes
• as client	Yes
• User data per job, max.	64 Kbyte

# Fault-tolerant automation with SIMATIC

## CPUs for process automation

### CPU 412-3H

Order No.	6ES7 412-3HJ14-0AB0
S5-compatible communication	
• supported	Yes; (via CP max. 10 and FC AG_SEND and FC AG_RECV) 8 Kbyte
• User data per job, max.	
Standard communication (FMS)	
• supported	Yes; Via CP and loadable FB
Number of connections	
• overall	16
<b>1st interface</b>	
Type of interface	Integrated
Physics	RS 485 / PROFIBUS + MPI
Isolated	Yes
Power supply to interface (15 to 30 V DC), max.	150 mA
Number of connection resources	MPI: 16, DP: 16
Functionality	
• MPI	Yes
• DP master	Yes
• DP slave	No
MPI	
• Number of connections	16
• Services	
- PG/OP communication	Yes
- Routing	Yes
- Global data communication	No
- S7 basic communication	No
- S7 communication	Yes
• Transmission rate, max.	12 Mbit/s
DP master	
• Number of connections, max.	16
• Services	
- PG/OP communication	Yes
- Routing	Yes
- Global data communication	No
- S7 basic communication	No
- S7 communication	Yes
- Equidistance mode support	No
- SYNC/FREEZE	No
- Activation/deactivation of DP slaves	No
- Direct data exchange (slave-to-slave communication)	No
• Transmission rate, max.	12 Mbit/s
• Number of DP slaves, max.	32
• Address area	
- Inputs, max.	2 Kbyte
- Outputs, max.	2 Kbyte
• User data per DP slave	
- User data per DP slave, max.	244 byte
- Inputs, max.	244 byte
- Outputs, max.	244 byte
- Slots, max.	244
- per slot, max.	128 byte
DP slave	
• Number of connections	No configuration of CPU as DP slave

Order No.	6ES7 412-3HJ14-0AB0
<b>3rd interface</b>	
Type of interface	Pluggable synchronization submodule (FO)
Plug-in interface modules	Synchronization submodule IF 960 6ES7 960-1AA04-0XA0
<b>4th interface</b>	
Type of interface	Pluggable synchronization submodule (FO)
Plug-in interface modules	Synchronization submodule IF 960 6ES7 960-1AA04-0XA0
<b>Isochronous mode</b>	
Isochronous mode	No
equidistance	No
<b>CiR - Configuration in RUN</b>	
CiR synchronization time, basic load	150 ms
CiR synchronization time, time per I/O slave	40 µs
<b>Programming</b>	
Configuration software	
• STEP 7	Yes; With hardware update as of STEP7 V5.3 SP2
Programming language	
• STEP 7	Yes
• LAD	Yes
• FBD	Yes
• STL	Yes
• SCL	Yes
• CFC	Yes
• GRAPH	Yes
• HiGraph®	Yes
Nesting levels	8
Know-how protection	
• User program protection/password protection	Yes
<b>Dimensions</b>	
Required slots	2
<b>Dimensions and weight</b>	
Dimensions	
• Width	50 mm
• Height	290 mm
• Depth	219 mm
Weight	
• Weight, approx.	990 g



### Selection and ordering data

	Order No.
<b>CPU 412-3H</b> For S7-400H and S7-400F/FH; RAM 768 KB, combined MPI/PROFIBUS DP master interface, 2 slots for synchroni- zation modules, slot for memory card, incl. slot number plate	<b>6ES7 412-3HJ14-0AB0</b>
<b>SIPLUS CPU 412-3H</b> For constructing a fail-safe automation system. Suitable for exceptional medial exposure.	<b>6AG1 412-3HJ14-4AB0</b>
<b>CPU 412-3H system bundle</b> Not installed, comprising: UR2-H mounting rack, 2 x PS 405/407 power supply, 2 x CPU 412-3H, 2 x memory card RAM (1 MB), 4 x sync module (for up to 10 m), 2 x fiber optic connecting cable for synchronization modules (1 m), 4 x backup battery	
<b>412H system bundle, 1 MB, 120/230 V, 10 A</b>	<b>6ES7 400-0HR00-4AB0</b>
<b>412H system bundle, 1 MB, 24/48/60 VDC, 10 A</b>	<b>6ES7 400-0HR50-4AB0</b>
<b>Memory card RAM</b>	
1 MB	<b>6ES7 952-1AK00-0AA0</b>
2 MB	<b>6ES7 952-1AL00-0AA0</b>
4 MB	<b>6ES7 952-1AM00-0AA0</b>
8 MB	<b>6ES7 952-1AP00-0AA0</b>
16 MB	<b>6ES7 952-1AS00-0AA0</b>
64 MB	<b>6ES7 952-1AY00-0AA0</b>
<b>FEPROM memory card</b>	
1 MB	<b>6ES7 952-1KK00-0AA0</b>
2 MB	<b>6ES7 952-1KL00-0AA0</b>
4 MB	<b>6ES7 952-1KM00-0AA0</b>
8 MB	<b>6ES7 952-1KP00-0AA0</b>
16 MB	<b>6ES7 952-1KS00-0AA0</b>
32 MB	<b>6ES7 952-1KT00-0AA0</b>
64 MB	<b>6ES7 952-1KY00-0AA0</b>
<b>MPI cable</b> for connection of SIMATIC S7 and PG via MPI; 5 m in length	<b>6ES7 901-0BF00-0AA0</b>
<b>Slot number plates</b> 1 set (spare part)	<b>6ES7 912-0AA00-0AA0</b>
<b>S7 F systems RT license</b> For processing safety-related user programs, for one S7 400H- based system in each case with CPU 412-3H, CPU 414-4H or CPU 417-4H	<b>6ES7 833-1CC00-6YX0</b>

	Order No.
<b>S7 F Systems V6.1</b> Programming and configuring environment for creating and operating safety-related STEP 7 programs for an S7 400H-based target system, floating license for 1 user, runs under Windows XP Prof SP2, Windows XP Prof SP2/SP3, Windows Server 2003 SP2 2 languages (English, German) Type of delivery: Certificate of license as well as software and electronic documentation on CD	<b>6ES7 833-1CC02-0YA5</b>
<b>S7 F systems upgrade from V5.x/V6.0 to V6.1</b> 2 languages (English, German), floating license for 1 user Type of delivery: Certificate of license as well as software and electronic documentation on CD	<b>6ES7 833-1CC02-0YE5</b>
<b>Manual "Communication for SIMATIC S7-300/-400"</b> German English French Spanish Italian	<b>6ES7 398-8EA00-8AA0</b> <b>6ES7 398-8EA00-8BA0</b> <b>6ES7 398-8EA00-8CA0</b> <b>6ES7 398-8EA00-8DA0</b> <b>6ES7 398-8EA00-8EA0</b>
<b>SIMATIC Manual Collection</b> Electronic manuals on DVD, multi- lingual: LOGO!, SIMADYN, SIMATIC bus components, SIMATIC C7, SIMATIC distributed I/O, SIMATIC HMI, SIMATIC Sensors, SIMATIC NET, SIMATIC PC Based Automation, SIMATIC PCS 7, SIMATIC PG/PC, SIMATIC S7, SIMATIC Software, SIMATIC TDC	<b>6ES7 998-8XC01-8YE0</b>
<b>SIMATIC Manual Collection update service for 1 year</b> Current "Manual Collection" DVD and the three subsequent updates	<b>6ES7 998-8XC01-8YE2</b>
<b>Brochure "SIMATIC S7-400 programmable controller - Design and application"</b> German English	<b>6ES7 498-8AA00-8AB0</b> <b>6ES7 498-8AA00-8BB0</b>
<b>RS 485 bus connector with 90° cable outlet</b> Max. transfer rate 12 Mbit/s without PG interface With PG interface	<b>6ES7 972-0BA12-0XA0</b> <b>6ES7 972-0BB12-0XA0</b>

# Fault-tolerant automation with SIMATIC

## CPUs for process automation

### CPU 412-3H

	Order No.
<b>RS 485 bus connector with angled cable outlet</b> Max. transfer rate 12 Mbit/s without PG interface With PG interface Max. transfer rate 1.5 Mbit/s without PG interface	<b>6ES7 972-0BA42-0XA0</b> <b>6ES7 972-0BB42-0XA0</b>  <b>6ES7 972-0BA30-0XA0</b>
<b>RS 485 bus connector with 90° cable outlet for Fast Connect system</b> Max. transfer rate 12 Mbit/s without PG interface <ul style="list-style-type: none"> <li>• 1 unit</li> <li>• 100 units</li> </ul> with PG interface <ul style="list-style-type: none"> <li>• 1 unit</li> <li>• 100 units</li> </ul>	<b>6ES7 972-0BA52-0XA0</b> <b>6ES7 972-0BA52-0XB0</b>  <b>6ES7 972-0BB52-0XA0</b> <b>6ES7 972-0BB52-0XB0</b>
<b>RS 485 bus connector with axial cable outlet</b> For SIMATIC OP, for connection to PPI, MPI, PROFIBUS	<b>6GK1 500-0EA02</b>
<b>PROFIBUS FastConnect bus cable</b> Standard type with special design for quick mounting, 2-core, shielded, sold by the meter, max. delivery unit 1000 m, minimum ordering quantity 20 m	<b>6XV1 830-0EH10</b>

### Overview



- CPU for SIMATIC S7-400H and S7-400F/FH.
- Can be used in high availability S7-400H systems
- Can be used with F-runtime license and F-compatible CPU in fail-safe S7-400F/FH systems
- With integrated PROFIBUS DP master interface
- With 2 slots for sync modules

### SIPLUS Version

A SIPLUS version of this module is also available.

SIPLUS CPU 414-4H	
Order No.	6AG1 414-4HM14-4AB0
Order No. based on	6ES7 414-4HM14-0AB0
Conformal coating	Coating material of circuit boards and of electronic circuitry in accordance with EN 60721
Technical data	The technical data are identical with those of the based-on module, except for the ambient conditions.
Permitted ambient temperature range	0 ... +60 °C
Permitted relative humidity	5 ... 100 %, condensation is allowed
Biologically active substances	Conformity with EN 60721-3-3, Class 3B2 mold and fungal spores (except fauna)
Chemically active substances	Conformity with EN 60721-3-3, Class 3C4 incl. salt mist and ISA-S71.04 severity level G1; G2; G3; GX <sup>1) 2)</sup>
Mechanically active substances	Conformity with EN 60721-3-3, Class 3S4 including conductive sand, dust <sup>2)</sup>
Air pressure (depending on the highest positive temperature range specified)	1080 ... 795 hPa (-1000 ... +2000 m) see ambient temperature range 795 ... 658 hPa (+2000 ... +3500 m), derating 10 K 658 ... 540 hPa (+3500 ... +5000 m), derating 20 K

1) ISA-S71.04 severity level GX: Long-term load: SO<sub>2</sub> < 4.8 ppm; H<sub>2</sub>S < 9.9 ppm; Cl < 0.2 ppm; HCl < 0.66 ppm; HF < 0.12 ppm; NH < 49 ppm; O<sub>3</sub> < 0.1 ppm; NO<sub>x</sub> < 5.2 ppm  
Limit value (max. 30 min/d): SO<sub>2</sub> < 17.8 ppm; H<sub>2</sub>S < 49.7 ppm; Cl < 1.0 ppm; HCl < 3.3 ppm; HF < 2.4 ppm; NH < 247 ppm; O<sub>3</sub> < 1.0 ppm; NO<sub>x</sub> < 10.4 ppm

2) The supplied plug covers must remain in place over the unused interface when operated in atmospheres containing corrosive gases!

Technical documentation for SIPLUS is available at:

<http://www.siemens.com/siplus-extreme>

### Application

The CPU 414-4H is compatible with the SIMATIC S7-400H and S7-400F/FH. It allows a fault-tolerant S7-400H system to be configured. It can also be used for the fail-safe S7-400F/FH automation system in conjunction with an F-runtime license. The integrated PROFIBUS DP interface supports direct connection to the PROFIBUS DP fieldbus as master.

### Design

The CPU 414-4H features:

- A powerful processor:  
The CPU achieves command runtimes as little as 45 ns per binary command.
- 2.8 MB main memory (1.4 MB for programs, 1.4 MB for data); load memory for user programs and configuration data for the S7-400H F/FH automation system; fast main memory for subroutines of the user program that are relevant to the process
- A memory card:  
For extending the integrated load memory. In addition to the program itself, the information contained in the load memory also includes configuration data for the S7-400H F/FH, which is why it takes up twice as much space in the memory. The result is that the integrated load memory is not sufficient for large programs, which is why the memory card is often required. RAM and FEPRAM cards are available (FEPRAM for saving even when not connected to the power supply).
- Easy removal:  
Max. 65K digital and 4K analog inputs/outputs.
- Multipoint-capable MPI interface:  
The MPI enables the creation of a simple network with max. 32 nodes and a data transfer rate of 187.5 Kbit/s. The CPU can establish up to 64 connections to users of the communication bus (C bus) and the MPI. Note: If PROFIBUS DP and MPI interfaces are being used simultaneously, only the following bus connectors can be connected to the MPI interface:  
- With socket: 6ES7 972-0BB41-0XA0  
- Without socket: 6ES7 972-0BA41-0XA0
- Mode selector:  
Designed as a toggle switch.
- Diagnostic buffer:  
The last 120 alarm and interrupt events are stored in a ring buffer for the purpose of diagnosis.
- Real-time clock:  
Diagnostic reports from the CPU are provided with the date and time.
- PROFIBUS DP interface:  
The CPU 414-4H with PROFIBUS DP master interface enables distributed automation to be established at high speed and with easy operation. From the user's point of view, the distributed peripherals are treated like centralized peripherals (same configuration, addressing and programming). Note: If PROFIBUS DP and MPI interfaces are being used simultaneously, only the following bus connectors can be connected to the MPI interface:  
- With socket: 6ES7 972-0BB41-0XA0  
- Without socket: 6ES7 972-0BA41-0XA0

# Fault-tolerant automation with SIMATIC

## CPUs for process automation

### CPU 414-4H

#### Function

- Block protection:  
A password concept also protects the user program from unauthorized access as well as the keyswitch.
- Integrated HMI services:  
The user only has to specify the source and destination of the data with HMI devices. The data are then transported cyclically and automatically by the system.
- Integrated communication functions:
  - PG/OP communication
  - Expanded communication (simple and high-availability)

#### Configurable Attributes

The STEP 7 "hardware configuration" tool and the installed S7-400H options package are used to configure the features and response of the S7-400H, including the CPUs, for example:

- Multipoint interface MPI:
  - Definition of node addresses
  - Startup/cycle behavior
  - Stipulation of the maximum cycle time and communication load
- Address allocation:  
Addressing of I/O modules
- Retentive area:  
Definition of the number of retentive bit memories, counters, timers, data blocks, and clock memories
- Protection level:  
Definition of access authorizations to program and data
- System diagnostics:  
Definition of the handling and scope of diagnostics messages
- Timed interrupts:  
Setting of periods
- Configuration of H stations

#### Safety-related functions

The F-runtime license can be used to compile the fail-safe F user program and run it on the CPU. A license is required for each S7-400F/FH system. 2 TÜV stickers are included.

#### Reporting functions

- Status and fault indicators:  
LEDs indicate internal and external errors and operating modes such as RUN, STOP, Startup, "Master" mode, redundancy error, test function, etc.
- Test functions:  
The PG can be used to display signal states in program execution, modify process tags irrespective of the user program, read out the contents of stack memories, run separate program steps and inhibit program components.
- Information functions:  
The PG can be used to provide the user with information about the memory capacity and operating mode of the CPU, and the current utilization of the working and load memories.

#### Technical specifications

Order No.	6ES7 414-4HM14-0AB0
<b>Product version</b>	
Hardware product version	1
Firmware version	V4.5
associated programming package	STEP7 V 5.3 SP2 or higher with HW update
<b>Supply voltages</b>	
Rated value	No; Power supply via system power supply
• 24 V DC	
Feeding of external backup voltage to CPU	5 to 15 VDC
<b>Current consumption</b>	
from backplane bus 5 V DC, max.	1.7 A
from interface 5 V DC, max.	90 mA; At each DP interface
<b>Power losses</b>	
Power loss, typ.	6 W
<b>Backup battery</b>	
Battery operation	
• Backup current, typ.	190 µA; Valid up to 40°C
• Backup current, max.	660 µA
<b>Memory</b>	
Work memory	
• integrated (for program)	1.4 Mbyte
• integrated (for data)	1.4 Mbyte
• expandable	No
Load memory	
• expandable FEPR0M	Yes
• expandable FEPR0M, max.	64 Mbyte
• integrated RAM, max.	256 Kbyte
• expandable RAM	Yes
• expandable RAM, max.	64 Mbyte
Backup	
• present	Yes
• with battery	Yes; All data
• without battery	No
<b>CPU-blocks</b>	
DB	
• Number, max.	4 095; Number range: 1 to 4095
• Size, max.	64 Kbyte
FB	
• Number, max.	2 048; Number range: 0 to 2047
• Size, max.	64 Kbyte
FC	
• Number, max.	2 048; Number range: 0 to 2047
• Size, max.	64 Kbyte
OB	
• Size, max.	64 Kbyte
Nesting depth	
• per priority class	24
• additional within an error OB	1
<b>CPU processing times</b>	
for bit operations, min.	0.045 µs
for word operations, min.	0.045 µs
for fixed point arithmetic, min.	0.045 µs
for floating point arithmetic, min.	0.135 µs

# Fault-tolerant automation with SIMATIC

## CPUs for process automation

CPU 414-4H

Order No.	6ES7 414-4HM14-0AB0
<b>Counters, timers and their retentivity</b>	
S7 counter	
• Number	2 048
• Retentivity	
- can be set	Yes
- lower limit	0
- upper limit	2 047
- preset	Z 0 to Z 7
• Counting range	
- lower limit	0
- upper limit	999
IEC counter	
• present	Yes
• Type	SFB
S7 times	
• Number	2 048
• Retentivity	
- can be set	Yes
- lower limit	0
- upper limit	2 047
- preset	No times retentive
• Time range	
- lower limit	10 ms
- upper limit	9 990 s
IEC timer	
• present	Yes
• Type	SFB
<b>Data areas and their retentivity</b>	
retentive data area, total	Total working and load memory (with backup battery)
Flag	
• Number, max.	8 Kbyte
• Retentivity available	Yes
• Number of clock memories	8; (in 1 memory byte)
Data blocks	
• Number, max.	4 095; Number range: 1 to 4095
• Size, max.	64 Kbyte
Local data	
• adjustable, max.	16 Kbyte
• preset	8 Kbyte
<b>Address area</b>	
I/O address area	
• overall	8 Kbyte
• Outputs	8 Kbyte
• of which, distributed	
- MPI/DP interface, inputs	2 Kbyte
- MPI/DP interface, outputs	2 Kbyte
- DP interface, inputs	6 Kbyte
- DP interface, outputs	6 Kbyte
Process image	
• Inputs, adjustable	8 Kbyte
• Outputs, adjustable	8 Kbyte
• Inputs, default	256 byte
• Outputs, default	256 byte
• consistent data, max.	244 byte
• Access to consistent data in process image	Yes
Subprocess images	
• Number of subprocess images, max.	15

Order No.	6ES7 414-4HM14-0AB0
Digital channels	
• Inputs	65 536
• Outputs	65 536
• Inputs, of which central	65 536
• Outputs, of which central	65 536
Analog channels	
• Inputs	4 096
• Outputs	4 096
• Inputs, of which central	4 096
• Outputs, of which central	4 096
<b>Hardware configuration</b>	
connectable OPs	31 without message processing, 8 with message processing
Central devices, max.	1
Expansion devices, max.	21
Multicomputing	No
Interface modules	
• Number of connectable IMs (total), max.	6
• Number of connectable IM 460s, max.	6
• Number of connectable IM 463s, max.	4; Single mode only
Number of DP masters	
• integrated	2
• via CP	10
• Mixed mode IM + CP permitted	No
Number of operable FMs and CPs (recommended)	
• FM	See manual Automation System S7-400H fault-tolerant systems. Limited by number of slots and number of connections
• CP, point-to-point	See manual Automation System S7-400H fault-tolerant systems. Limited by number of slots and number of connections
• PROFIBUS and Ethernet CPs	14; of which max. 10 CP as DP master
<b>Time of day</b>	
Clock	
• Hardware clock (real-time clock)	Yes
• battery-backed and synchronizable	Yes
• Resolution	1 ms
Runtime meter	
• Number	8
Clock synchronization	
• supported	Yes
• to MPI, master	Yes
• to MPI, slave	Yes
• to DP, master	Yes
• to DP, slave	Yes
• in AS, master	Yes
• in AS, slave	Yes
<b>S7 message functions</b>	
Number of login stations for message functions, max.	8
Symbol-related messages	No
Block related messages	Yes
Alarm 8-blocks	Yes
Process control messages	Yes
<b>Test commissioning functions</b>	
Status/control	
• Status/control variable	Yes

3

# Fault-tolerant automation with SIMATIC

## CPUs for process automation

### CPU 414-4H

Order No.	6ES7 414-4HM14-0AB0
Forcing	
• Forcing	Yes
Status block	Yes
Single step	Yes
Number of breakpoints	4
Diagnostics buffer	
• present	Yes
• Number of entries, max.	3 200
- can be set	Yes
- preset	120
<b>Communication functions</b>	
PG/OP communication	Yes
Routing	Yes
Global data communication	
• supported	No
S7 basic communication	
• supported	No
S7 communication	
• supported	Yes
• as server	Yes
• as client	Yes
• User data per job, max.	64 Kbyte
S5-compatible communication	
• supported	Yes; (via CP max. 10 and FC AG_SEND and FC AG_RECV)
• User data per job, max.	8 Kbyte
Standard communication (FMS)	
• supported	Yes; Via CP and loadable FB
Number of connections	
• overall	32
<b>1st interface</b>	
Type of interface	Integrated
Physics	RS 485 / PROFIBUS + MPI
Isolated	Yes
Power supply to interface (15 to 30 V DC), max.	150 mA
Number of connection resources	MPI: 32, DP: 32
Functionality	
• MPI	Yes
• DP master	Yes
• DP slave	No
MPI	
• Number of connections	32
• Services	
- PG/OP communication	Yes
- Routing	Yes
- Global data communication	No
- S7 basic communication	No
- S7 communication	Yes
• Transmission rate, max.	12 Mbit/s
DP master	
• Number of connections, max.	16
• Services	
- PG/OP communication	Yes
- Routing	Yes
- Global data communication	No
- S7 basic communication	No
- S7 communication	Yes
- Equidistance mode support	No
- SYNC/FREEZE	No
- Activation/deactivation of DP slaves	No

Order No.	6ES7 414-4HM14-0AB0
• Direct data exchange (slave-to-slave communication)	No
• Transmission rate, max.	12 Mbit/s
• Number of DP slaves, max.	32
• Address area	
- Inputs, max.	2 Kbyte
- Outputs, max.	2 Kbyte
• User data per DP slave	
- User data per DP slave, max.	244 byte
- Inputs, max.	244 byte
- Outputs, max.	244 byte
- Slots, max.	244
- per slot, max.	128 byte
<b>2nd interface</b>	
Type of interface	Integrated
Physics	RS 485 / PROFIBUS + MPI
Isolated	Yes
Power supply to interface (15 to 30 V DC), max.	150 mA
Number of connection resources	16
Functionality	
• DP master	Yes
• DP slave	No
DP master	
• Number of connections, max.	16
• Services	
- PG/OP communication	Yes
- Routing	Yes
- Global data communication	No
- S7 basic communication	No
- S7 communication	Yes
- Equidistance mode support	No
- SYNC/FREEZE	No
- Activation/deactivation of DP slaves	No
- Direct data exchange (slave-to-slave communication)	No
• Transmission rate, max.	12 Mbit/s
• Number of DP slaves, max.	96
• Address area	
- Inputs, max.	6 Kbyte
- Outputs, max.	6 Kbyte
• User data per DP slave	
- User data per DP slave, max.	244 byte
- Inputs, max.	244 byte
- Outputs, max.	244 byte
- Slots, max.	244
- per slot, max.	128 byte
<b>3rd interface</b>	
Type of interface	Pluggable synchronization submodule (FO)
Plug-in interface modules	Synchronization submodule IF 960 6ES7 960-1AA04-0XA0 or 6ES7 960-1AB04-0XA0
<b>4th interface</b>	
Type of interface	Pluggable synchronization submodule (FO)
Plug-in interface modules	Synchronization submodule IF 960 6ES7 960-1AA04-0XA0 or 6ES7 960-1AB04-0XA0
<b>CiR - Configuration in RUN</b>	
CiR synchronization time, basic load	100 ms
CiR synchronization time, time per I/O slave	25 µs

# Fault-tolerant automation with SIMATIC

## CPUs for process automation

CPU 414-4H

Order No.	6ES7 414-4HM14-0AB0
<b>Programming</b>	
Configuration software • STEP 7	Yes; With hardware update as of STEP7 V5.3 SP2
Programming language • STEP 7 • LAD • FBD • STL • SCL • CFC • GRAPH • HiGraph®	Yes Yes Yes Yes Yes Yes Yes
Nesting levels	8
Know-how protection • User program protection/password protection	Yes
<b>Dimensions</b>	
Required slots	2
<b>Dimensions and weight</b>	
Dimensions • Width • Height • Depth	50 mm 290 mm 219 mm
Weight • Weight, approx.	995 g

### Selection and ordering data

	Order No.
<b>CPU 414-4H</b>	<b>6ES7 414-4HM14-0AB0</b>
For S7-400H and S7-400F/FH; RAM 2.8 MB, MPI/PROFIBUS DP master interface, 2 slots for synchronization modules, slot for memory card, incl. slot number plate	
<b>SIPLUS CPU 414-4H</b>	<b>6AG1 414-4MH14-4AB0</b>
For constructing a fail-safe automation system. Suitable for exceptional medial exposure.	
<b>Memory card RAM</b>	
1 MB	<b>6ES7 952-1AK00-0AA0</b>
2 MB	<b>6ES7 952-1AL00-0AA0</b>
4 MB	<b>6ES7 952-1AM00-0AA0</b>
8 MB	<b>6ES7 952-1AP00-0AA0</b>
16 MB	<b>6ES7 952-1AS00-0AA0</b>
64 MB	<b>6ES7 952-1AY00-0AA0</b>
<b>FEPROM memory card</b>	
1 MB	<b>6ES7 952-1KK00-0AA0</b>
2 MB	<b>6ES7 952-1KL00-0AA0</b>
4 MB	<b>6ES7 952-1KM00-0AA0</b>
8 MB	<b>6ES7 952-1KP00-0AA0</b>
16 MB	<b>6ES7 952-1KS00-0AA0</b>
32 MB	<b>6ES7 952-1KT00-0AA0</b>
64 MB	<b>6ES7 952-1KY00-0AA0</b>
<b>MPI cable</b>	<b>6ES7 901-0BF00-0AA0</b>
for connection of SIMATIC S7 and PG via MPI; 5 m in length	

	Order No.
<b>Slot number plates</b>	<b>6ES7 912-0AA00-0AA0</b>
1 set (spare part)	
<b>S7 F systems RT license</b>	<b>6ES7 833-1CC00-6YX0</b>
For processing safety-related user programs, for one S7 400H-based system in each case with CPU 412-3H, CPU 414-4H or CPU 417-4H	
<b>S7 F Systems V6.1</b>	<b>6ES7 833-1CC02-0YA5</b>
Programming and configuring environment for creating and operating safety-related STEP 7 programs for an S7 400H-based target system, floating license for 1 user, runs under Windows XP Prof SP2/SP3, Windows Server 2003 SP2 2 languages (English, German) Type of delivery: Certificate of license as well as software and electronic documentation on CD	
<b>S7 F systems upgrade from V5.x/V6.0 to V6.1</b>	<b>6ES7 833-1CC02-0YE5</b>
2 languages (English, German), floating license for 1 user Type of delivery: Certificate of license as well as software and electronic documentation on CD	
<b>Manual "Communication for SIMATIC S7-300/-400"</b>	
German	<b>6ES7 398-8EA00-8AA0</b>
English	<b>6ES7 398-8EA00-8BA0</b>
French	<b>6ES7 398-8EA00-8CA0</b>
Spanish	<b>6ES7 398-8EA00-8DA0</b>
Italian	<b>6ES7 398-8EA00-8EA0</b>
<b>SIMATIC Manual Collection</b>	<b>6ES7 998-8XC01-8YE0</b>
Electronic manuals on DVD, multi-lingual: LOGO!, SIMADYN, SIMATIC bus components, SIMATIC C7, SIMATIC distributed I/O, SIMATIC HMI, SIMATIC Sensors, SIMATIC NET, SIMATIC PC Based Automation, SIMATIC PCS 7, SIMATIC PG/PC, SIMATIC S7, SIMATIC Software, SIMATIC TDC	
<b>SIMATIC Manual Collection update service for 1 year</b>	<b>6ES7 998-8XC01-8YE2</b>
Current "Manual Collection" DVD and the three subsequent updates	
<b>Brochure "SIMATIC S7-400 programmable controller - Design and application"</b>	
German	<b>6ES7 498-8AA00-8AB0</b>
English	<b>6ES7 498-8AA00-8BB0</b>
<b>RS 485 bus connector with 90° cable outlet</b>	
Max. transfer rate 12 Mbit/s without PG interface	<b>6ES7 972-0BA12-0XA0</b>
With PG interface	<b>6ES7 972-0BB12-0XA0</b>

3

# Fault-tolerant automation with SIMATIC

## CPUs for process automation

### CPU 414-4H

	Order No.
<b>RS 485 bus connector with angled cable outlet</b> Max. transfer rate 12 Mbit/s without PG interface With PG interface Max. transfer rate 1.5 Mbit/s without PG interface	 <b>6ES7 972-0BA42-0XA0</b> <b>6ES7 972-0BB42-0XA0</b>  <b>6ES7 972-0BA30-0XA0</b>
<b>RS 485 bus connector with 90° cable outlet for Fast Connect system</b> Max. transfer rate 12 Mbit/s without PG interface • 1 unit • 100 units with PG interface • 1 unit • 100 units	 <b>6ES7 972-0BA52-0XA0</b> <b>6ES7 972-0BA52-0XB0</b>  <b>6ES7 972-0BB52-0XA0</b> <b>6ES7 972-0BB52-0XB0</b>
<b>RS 485 bus connector with axial cable outlet</b> For SIMATIC OP, for connection to PPI, MPI, PROFIBUS	<b>6GK1 500-0EA02</b>
<b>PROFIBUS FastConnect bus cable</b> Standard type with special design for quick mounting, 2-core, shielded, sold by the meter, max. delivery unit 1000 m, minimum ordering quantity 20 m	<b>6XV1 830-0EH10</b>



### Overview



- CPU for SIMATIC S7-400H and S7-400F/FH
- Can be used in high availability S7-400H systems
- Can be used with F-runtime license and F-compatible CPU in fail-safe S7-400F/FH systems
- With integrated PROFIBUS DP master interface
- With 2 slots for sync modules

### SIPLUS Version

A SIPLUS version of this module is also available.

SIPLUS CPU 417-4H	
Order No.	6AG1 417-4HT14-4AB0
Order No. based on	6ES7 417-4HT14-0AB0
Conformal coating	Coating material of circuit boards and of electronic circuitry in accordance with EN 60721
Technical data	The technical data are identical with those of the based-on module, except for the ambient conditions.
Permitted ambient temperature range	0 ... +60 °C
Permitted relative humidity	5 ... 100 %, condensation is allowed
Biologically active substances	Conformity with EN 60721-3-3, Class 3B2 mold and fungal spores (except fauna)
Chemically active substances	Conformity with EN 60721-3-3, Class 3C4 incl. salt mist and ISA-S71.04 severity level G1; G2; G3; GX <sup>1) 2)</sup>
Mechanically active substances	Conformity with EN 60721-3-3, Class 3S4 including conductive sand, dust <sup>2)</sup>
Air pressure (depending on the highest positive temperature range specified)	1080 ... 795 hPa (-1000 ... +2000 m) 795 ... 658 hPa (+2000 ... +3500 m), derating 10 K 658 ... 540 hPa (+3500 ... +5000 m), derating 20 K

1) ISA-S71.04 severity level GX: Long-term load: SO<sub>2</sub> < 4.8 ppm; H<sub>2</sub>S < 9.9 ppm; Cl < 0.2 ppm; HCl < 0.66 ppm; HF < 0.12 ppm; NH < 49 ppm; O<sub>3</sub> < 0.1 ppm; NO<sub>x</sub> < 5.2 ppm  
Limit value (max. 30 min/d): SO<sub>2</sub> < 17.8 ppm; H<sub>2</sub>S < 49.7 ppm; Cl < 1.0 ppm; HCl < 3.3 ppm; HF < 2.4 ppm; NH < 247 ppm; O<sub>3</sub> < 1.0 ppm; NO<sub>x</sub> < 10.4 ppm

2) The supplied plug covers must remain in place over the unused interface when operated in atmospheres containing corrosive gases!

Technical documentation for SIPLUS is available at:

<http://www.siemens.com/siplus-extreme>

### Application

The CPU 417-4H is the most powerful CPU for the SIMATIC S7-400H and S7-400F/FH. It allows a fault-tolerant S7-400H system to be configured. It can also be used for the fail-safe S7-400F/FH automation system in conjunction with an F-runtime license.

The integrated PROFIBUS DP interface supports direct connection to the PROFIBUS DP fieldbus as master.

### Design

The CPU 417-4H features:

- A powerful processor:  
The CPU achieves command runtimes as little as 18 ns per binary command.
- 30 MB main memory (15 MB for programs, 15 MB for data):  
Load memory for user programs and configuration data for the S7-400H automation system; Fast main memory for subroutines of the user program that are relevant to the process.
- A memory card:  
For expanding the integrated load memory. In addition to the program itself, the information contained in the load memory also includes configuration data for the S7-400H, which is why it takes up twice as much space in the memory. The result is that the integrated load memory is not sufficient for large programs, which is why the memory card is often required. RAM and FEPROM cards are available (FEPROM for saving at zero voltage, too).
- Easy expandability:  
Max. 128K digital and 8K analog inputs/outputs.
- Multipoint-capable MPI interface:  
The MPI enables the creation of a simple network with max. 32 nodes and a data transfer rate of 187.5 Kbit/s. The CPU can establish up to 64 connections to users of the communication bus (C bus) and the MPI. Note: If PROFIBUS DP and MPI interfaces are being used simultaneously, only the following bus connectors can be connected to the MPI interface:
  - With socket: 6ES7 972-0BB41-0XA0
  - Without socket: 6ES7 972-0BA41-0XA0
- Mode selector:  
Designed as a toggle switch.
- Diagnostics buffer:  
The last 120 alarm and interrupt events are stored in a ring buffer for the purpose of diagnosis.
- Real-time clock:  
Diagnostics reports from the CPU are provided with the date and time.
- PROFIBUS DP interface:  
The CPU 417-4H with PROFIBUS DP master interface enables distributed automation to be established at high speed and with easy operation. From the user's point of view, the distributed I/Os are treated like centralized I/Os (same configuration, addressing and programming).

### Note

If PROFIBUS DP and MPI interfaces are being used simultaneously, only the following bus connectors can be connected to the MPI interface:

- With socket: 6ES7 972-0BB41-0XA0
- Without socket: 6ES7 972-0BA41-0XA0

# Fault-tolerant automation with SIMATIC

## CPUs for process automation

### CPU 417-4H

#### Function

- Block protection:  
A password concept also protects the user program from unauthorized access as well as the keyswitch.
- Integrated HMI services:  
The user only has to specify the source and destination of the data with HMI devices. The data are then transported cyclically and automatically by the system.
- Integrated communication functions:
  - PG/OP communication
  - Expanded communication (simple and high-availability)

#### Configurable Attributes

The STEP 7 "hardware configuration" tool and the installed S7-400H options package are used to configure the features and response of the S7-400H, including the CPUs, for example:

- Multipoint interface MPI:
  - Definition of node addresses
  - Startup/cycle behavior
  - Stipulation of the maximum cycle time and communication load
- Address allocation:  
Addressing of I/O modules
- Retentive area:  
Definition of the number of retentive bit memories, counters, timers, data blocks, and clock memories
- Protection level:  
Definition of access authorizations to program and data
- System diagnostics:  
Definition of the handling and scope of diagnostics messages
- Timed interrupts:  
Setting of periods
- Configuration of H stations

#### Safety-related functions

The F-runtime license can be used to compile the fail-safe F user program and run it on the CPU. A license is required for each S7-400F/FH system. 2 TÜV stickers are included.

#### Reporting functions

- Status and fault indicators:  
LEDs indicate internal and external errors and operating modes such as RUN, STOP, Startup, "Master" mode, redundancy error, test function, etc.
- Test functions:  
The PG can be used to display signal states in program execution, modify process tags irrespective of the user program, read out the contents of stack memories, run separate program steps and inhibit program components.
- Information functions:  
The PG can be used to provide the user with information about the memory capacity and operating mode of the CPU, and the current utilization of the working and load memories.

#### Technical specifications

Order No.	6ES7 417-4HT14-0AB0
<b>Product version</b>	
Hardware product version	1
Firmware version	V4.5
associated programming package	STEP7 V 5.3 SP2 or higher with HW update
<b>Supply voltages</b>	
Rated value	
• 24 V DC	No; power supply via system power supply
Feeding of external backup voltage to CPU	5 to 15 VDC

Order No.	6ES7 417-4HT14-0AB0
<b>Current consumption</b>	
from backplane bus 5 V DC, max.	1.8 A
from interface 5 V DC, max.	90 mA; at each DP interface
<b>Power losses</b>	
Power loss, typ.	6.5 W
<b>Backup battery</b>	
Battery operation	
• Backup current, typ.	970 µA; valid up to 40°C
• Backup current, max.	1 980 µA
<b>Memory</b>	
Work memory	
• integrated (for program)	15 Mbyte
• integrated (for data)	15 Mbyte
• expandable	No
Load memory	
• expandable FEPRM	Yes
• expandable FEPRM, max.	64 Mbyte
• integrated RAM, max.	256 Kbyte
• expandable RAM	Yes
• expandable RAM, max.	64 Mbyte
Backup	
• present	Yes
• with battery	Yes; All data
• without battery	No
<b>CPU-blocks</b>	
DB	
• Number, max.	8 191; number range: 1 - 8191
• Size, max.	64 Kbyte
FB	
• Number, max.	6 144; number range: 0 - 6143
• Size, max.	64 Kbyte
FC	
• Number, max.	6 144; number range: 0 - 6143
• Size, max.	64 Kbyte
OB	
• Size, max.	64 Kbyte
Nesting depth	
• per priority class	24
• additional within an error OB	2
<b>CPU processing times</b>	
for bit operations, min.	0.018 µs
for word operations, min.	0.018 µs
for fixed point arithmetic, min.	0.018 µs
for floating point arithmetic, min.	0.054 µs
<b>Counters, timers and their retentivity</b>	
S7 counter	
• Number	2 048
• Retentivity	
- can be set	Yes
- lower limit	0
- upper limit	2 047
- preset	Z 0 to Z 7
• Counting range	
- lower limit	0
- upper limit	999
IEC counter	
• present	Yes
• Type	SFB

# Fault-tolerant automation with SIMATIC

## CPUs for process automation

### CPU 417-4H

Order No.	6ES7 417-4HT14-0AB0
S7 times	
• Number	2 048
• Retentivity	
- can be set	Yes
- lower limit	0
- upper limit	2 047
- preset	No times retentive
• Time range	
- lower limit	10 ms
- upper limit	9 990 s
IEC timer	
• present	Yes
• Type	SFB
<b>Data areas and their retentivity</b>	
retentive data area, total	Total working and load memory (with backup battery)
Flag	
• Number, max.	16 Kbyte
• Retentivity available	Yes
• Number of clock memories	8; (in 1 memory byte)
Data blocks	
• Number, max.	8 191; Number range: 1 - 8191
• Size, max.	64 Kbyte
Local data	
• adjustable, max.	64 Kbyte
• preset	32 Kbyte
<b>Address area</b>	
I/O address area	
• overall	16 Kbyte
• Outputs	16 Kbyte
• of which, distributed	
- MPI/DP interface, inputs	2 Kbyte
- MPI/DP interface, outputs	2 Kbyte
- DP interface, inputs	8 Kbyte
- DP interface, outputs	8 Kbyte
Process image	
• Inputs, adjustable	16 Kbyte
• Outputs, adjustable	16 Kbyte
• Inputs, default	1 024 byte
• Outputs, default	1 024 byte
• consistent data, max.	244 byte
• Access to consistent data in process image	Yes
Subprocess images	
• Number of subprocess images, max.	15
Digital channels	
• Inputs	131 072
• Outputs	131 072
• Inputs, of which central	131 072
• Outputs, of which central	131 072
Analog channels	
• Inputs	8 192
• Outputs	8 192
• Inputs, of which central	8 192
• Outputs, of which central	8 192
<b>Hardware configuration</b>	
connectable OPs	63 without message processing, 16 with message processing
Central devices, max.	1
Expansion devices, max.	21
Multicomputing	No
Interface modules	
• Number of connectable IMs (total), max.	6

Order No.	6ES7 417-4HT14-0AB0
• Number of connectable IM 460s, max.	6
• Number of connectable IM 463s, max.	4; Single mode only
Number of DP masters	
• integrated	2
• via CP	10
• Mixed mode IM + CP permitted	No
Number of operable FMs and CPs (recommended)	
• FM	See manual Automation System S7-400H fault-tolerant systems. Limited by number of slots and number of connections
• CP, point-to-point	See manual Automation System S7-400H fault-tolerant systems. Limited by number of slots and number of connections
• PROFIBUS and Ethernet CPs	14; of which max. 10 CP as DP master
<b>Time of day</b>	
Clock	
• Hardware clock (real-time clock)	Yes
• battery-backed and synchronizable	Yes
• Resolution	1 ms
Runtime meter	
• Number	8
Clock synchronization	
• supported	Yes
• to MPI, master	Yes
• to MPI, slave	Yes
• to DP, master	Yes
• to DP, slave	Yes
• in AS, master	Yes
• in AS, slave	Yes
<b>S7 message functions</b>	
Number of login stations for message functions, max.	16
Symbol-related messages	No
Block related messages	Yes
Alarm 8-blocks	Yes
Process control messages	Yes
<b>Test commissioning functions</b>	
Status/control	
• Status/control variable	Yes
Forcing	
• Forcing	Yes
Status block	Yes
Single step	Yes
Number of breakpoints	4
Diagnostic buffer	
• present	Yes
• Number of entries, max.	3 200
- can be set	Yes
- preset	120
<b>Communication functions</b>	
PG/OP communication	Yes
Routing	Yes
Global data communication	
• supported	No
S7 basic communication	
• supported	No

# Fault-tolerant automation with SIMATIC

## CPUs for process automation

### CPU 417-4H

Order No.	6ES7 417-4HT14-0AB0
S7 communication	
• supported	Yes
• as server	Yes
• as client	Yes
• User data per job, max.	64 Kbyte
S5-compatible communication	
• supported	Yes; (via CP max. 10 and FC AG_SEND and FC AG_RECV)
• User data per job, max.	8 Kbyte
Standard communication (FMS)	
• supported	Yes; Via CP and loadable FB
Number of connections	
• overall	64
<b>1st interface</b>	
Type of interface	Integrated
Physics	RS 485 / PROFIBUS + MPI
Isolated	Yes
Power supply to interface (15 to 30 V DC), max.	150 mA
Number of connection resources	MPI: 44, DP: 32
Functionality	
• MPI	Yes
• DP master	Yes
• DP slave	No
MPI	
• Number of connections	44
• Services	
- PG/OP communication	Yes
- Routing	Yes
- Global data communication	No
- S7 basic communication	No
- S7 communication	Yes
- S7 communication, as client	Yes
- S7 communication, as server	Yes
• Transmission rate, max.	12 Mbit/s
DP master	
• Number of connections, max.	32
• Services	
- PG/OP communication	Yes
- Routing	Yes
- Global data communication	No
- S7 basic communication	No
- S7 communication	Yes
- S7 communication, as client	Yes
- S7 communication, as server	Yes
- Equidistance mode support	No
- SYNC/FREEZE	No
- Activation/deactivation of DP slaves	No
- Direct data exchange (slave-to-slave communication)	No
• Transmission rate, max.	12 Mbit/s
• Number of DP slaves, max.	32
• Address area	
- Inputs, max.	2 Kbyte
- Outputs, max.	2 Kbyte
• User data per DP slave	
- User data per DP slave, max.	244 byte
- Inputs, max.	244 byte
- Outputs, max.	244 byte
- Slots, max.	244
- per slot, max.	128 byte
<b>2nd interface</b>	
Type of interface	Integrated
Physics	RS 485 / PROFIBUS + MPI

Order No.	6ES7 417-4HT14-0AB0
Isolated	Yes
Power supply to interface (15 to 30 V DC), max.	150 mA
Number of connection resources	32
Functionality	
• DP master	Yes
• DP slave	No
DP master	
• Number of connections, max.	32
• Services	
- PG/OP communication	Yes
- Routing	Yes
- Global data communication	No
- S7 basic communication	No
- S7 communication	Yes
- Equidistance mode support	No
- SYNC/FREEZE	No
- Direct data exchange (slave-to-slave communication)	No
• Transmission rate, max.	12 Mbit/s
• Number of DP slaves, max.	125
• Address area	
- Inputs, max.	8 Kbyte
- Outputs, max.	8 Kbyte
• User data per DP slave	
- User data per DP slave, max.	244 byte
- Inputs, max.	244 byte
- Outputs, max.	244 byte
- Slots, max.	244
- per slot, max.	128 byte
<b>3rd interface</b>	
Type of interface	Pluggable synchronization submodule (FO)
Plug-in interface modules	Synchronization submodule IF 960 6ES7 960-1AA04-0XA0 or 6ES7 960-1AB04-0XA0
<b>4th interface</b>	
Type of interface	Pluggable synchronization submodule (FO)
Plug-in interface modules	Synchronization submodule IF 960 6ES7 960-1AA04-0XA0 or 6ES7 960-1AB04-0XA0
<b>CiR - Configuration in RUN</b>	
CiR synchronization time, basic load	60 ms
CiR synchronization time, time per I/O slave	10 µs
<b>programming</b>	
Configuration software	
• STEP 7	Yes; With hardware update as of STEP7 V5.3 SP2
Programming language	
• STEP 7	Yes
• LAD	Yes
• FBD	Yes
• STL	Yes
• SCL	Yes
• CFC	Yes
• GRAPH	Yes
• HiGraph®	Yes
Nesting levels	8
Know-how protection	
• User program protection/password protection	Yes

# Fault-tolerant automation with SIMATIC

## CPUs for process automation

CPU 417-4H

<b>Order No.</b>	<b>6ES7 417-4HT14-0AB0</b>
<b>Dimensions</b>	
Required slots	2
<b>Dimensions and weight</b>	
Dimensions	
• Width	50 mm
• Height	290 mm
• Depth	219 mm
Weight	
• Weight, approx.	995 g

### Selection and ordering data

	Order No.
<b>CPU 417-4H</b>	<b>6ES7 417-4HT14-0AB0</b>
For S7-400H and S7-400F/FH; RAM 30 MB, MPI/PROFIBUS DP master interface, 2 slots for synchronization modules, slot for memory card, incl. slot number plate	
<b>SIPLUS CPU 417-4H</b>	<b>6AG1 417-4HT14-4AB0</b>
For constructing a fail-safe automation system. Suitable for exceptional medial exposure.	
<b>Memory card RAM</b>	
1 MB	<b>6ES7 952-1AK00-0AA0</b>
2 MB	<b>6ES7 952-1AL00-0AA0</b>
4 MB	<b>6ES7 952-1AM00-0AA0</b>
8 MB	<b>6ES7 952-1AP00-0AA0</b>
16 MB	<b>6ES7 952-1AS00-0AA0</b>
64 MB	<b>6ES7 952-1AY00-0AA0</b>
<b>FEPROM memory card</b>	
1 MB	<b>6ES7 952-1KK00-0AA0</b>
2 MB	<b>6ES7 952-1KL00-0AA0</b>
4 MB	<b>6ES7 952-1KM00-0AA0</b>
8 MB	<b>6ES7 952-1KP00-0AA0</b>
16 MB	<b>6ES7 952-1KS00-0AA0</b>
32 MB	<b>6ES7 952-1KT00-0AA0</b>
64 MB	<b>6ES7 952-1KY00-0AA0</b>
<b>MPI cable</b>	<b>6ES7 901-0BF00-0AA0</b>
for connection of SIMATIC S7 and PG via MPI; 5 m in length	
<b>Slot number plates</b>	<b>6ES7 912-0AA00-0AA0</b>
1 set (spare part)	
<b>S7 F systems RT license</b>	<b>6ES7 833-1CC00-6YX0</b>
For processing safety-related user programs, for one S7 400H-based system in each case with CPU 412-3H, CPU 414-4H or CPU 417-4H	
<b>S7 F Systems V6.1</b>	<b>6ES7 833-1CC02-0YA5</b>
Programming and configuring environment for creating and operating safety-related STEP 7 programs for an S7 400H-based target system, floating license for 1 user, runs under Windows XP Prof SP2, Windows XP Prof SP2/SP3, Windows Server 2003 SP2 2 languages (English, German) <i>Type of delivery:</i> Certificate of license as well as software and electronic documentation on CD	
<b>S7 F systems upgrade from V5.x/V6.0 to V6.1</b>	<b>6ES7 833-1CC02-0YE5</b>
2 languages (English, German), floating license for 1 user <i>Type of delivery:</i> Certificate of license as well as software and electronic documentation on CD	

# Fault-tolerant automation with SIMATIC

## CPUs for process automation

### CPU 417-4H

	Order No.
<b>S7 F systems V6.0</b> Programming and configuring environment for creating and operating safety-related STEP 7 programs for an S7 400H-based target system, floating license for 1 user, runs under Windows XP Prof SP2, Windows 2000 SP4, Windows Server 2003 SP1/SP2 2 languages (English, German) <i>Type of delivery:</i> Certificate of license as well as software and electronic documentation on CD	<b>6ES7 833-1CC01-0YA5</b>
<b>S7 F systems upgrade from V5.x to V6.0</b> 2 languages (English, German), floating license for 1 user <i>Type of delivery:</i> Certificate of license as well as software and electronic documentation on CD	<b>6ES7 833-1CC01-0YE5</b>
<b>Manual "Communication for SIMATIC S7-300/-400"</b> German English French Spanish Italian	<b>6ES7 398-8EA00-8AA0</b> <b>6ES7 398-8EA00-8BA0</b> <b>6ES7 398-8EA00-8CA0</b> <b>6ES7 398-8EA00-8DA0</b> <b>6ES7 398-8EA00-8EA0</b>
<b>SIMATIC Manual Collection</b> Electronic manuals on DVD, multilingual: LOGO!, SIMADYN, SIMATIC bus components, SIMATIC C7, SIMATIC distributed I/O, SIMATIC HMI, SIMATIC Sensors, SIMATIC NET, SIMATIC PC Based Automation, SIMATIC PCS 7, SIMATIC PG/PC, SIMATIC S7, SIMATIC Software, SIMATIC TDC	<b>6ES7 998-8XC01-8YE0</b>
<b>SIMATIC Manual Collection update service for 1 year</b> Current "Manual Collection" DVD and the three subsequent updates	<b>6ES7 998-8XC01-8YE2</b>
<b>Brochure "SIMATIC S7-400 programmable controller - Design and application"</b> <ul style="list-style-type: none"> <li>• German</li> <li>• English</li> </ul>	<b>6ES7 498-8AA00-8AB0</b> <b>6ES7 498-8AA00-8BB0</b>
<b>RS 485 bus connector with 90° cable outlet</b> Max. transfer rate 12 Mbit/s: <ul style="list-style-type: none"> <li>• without PG interface</li> <li>• with PG interface</li> </ul>	<b>6ES7 972-0BA12-0XA0</b> <b>6ES7 972-0BB12-0XA0</b>
<b>RS 485 bus connector with angled cable outlet</b> Max. transfer rate 12 Mbit/s: <ul style="list-style-type: none"> <li>• without PG interface</li> <li>• with PG interface</li> </ul> Max. transfer rate 1.5 Mbit/s: <ul style="list-style-type: none"> <li>• without PG interface</li> </ul>	<b>6ES7 972-0BA42-0XA0</b> <b>6ES7 972-0BB42-0XA0</b> <b>6ES7 972-0BA30-0XA0</b>

	Order No.
<b>RS 485 bus connector with 90° cable outlet for Fast Connect system</b> Max. transfer rate 12 Mbit/s: <ul style="list-style-type: none"> <li>• without PG interface               <ul style="list-style-type: none"> <li>- 1 unit</li> <li>- 100 units</li> </ul> </li> <li>• with PG interface               <ul style="list-style-type: none"> <li>- 1 unit</li> <li>- 100 units</li> </ul> </li> </ul>	<b>6ES7 972-0BA52-0XA0</b> <b>6ES7 972-0BA52-0XB0</b> <b>6ES7 972-0BB52-0XA0</b> <b>6ES7 972-0BB52-0XB0</b>
<b>RS 485 bus connector with axial cable outlet</b> For SIMATIC OP, for connection to PPI, MPI, PROFIBUS	<b>6GK1 500-0EA02</b>
<b>PROFIBUS FastConnect bus cable</b> Standard type with special design for quick mounting, 2-core, shielded, sold by the meter, max. delivery unit 1000 m, minimum ordering quantity 20 m	<b>6XV1 830-0EH10</b>

# Fault-tolerant automation with SIMATIC

## CPUs for process automation

### Sync module for coupling the CPU 41xH

#### Overview



- For coupling the two CPU 41xH in the S7-400H subunits.
- Can be plugged direct into the CPU

#### SIPLUS Version

A SIPLUS version of this module is also available.

SIPLUS sync module	
<b>Order No.</b>	<b>6AG1 960-1AA04-4XA0</b>
<b>Order No. based on</b>	<b>6ES7 960-1AA04-0XA0</b>
Conformal coating	Coating material of circuit boards and of electronic circuitry in accordance with EN 60721
Technical data	The technical data are identical with those of the based-on module, except for the ambient conditions.
Permitted ambient temperature range	0 ... +60 °C
Permitted relative humidity	5 ... 100 %, condensation is allowed
Biologically active substances	Conformity with EN 60721-3-3, Class 3B2 mold and fungal spores (except fauna)
Chemically active substances	Conformity with EN 60721-3-3, Class 3C4 incl. salt mist and ISA-S71.04 severity level G1; G2; G3; GX <sup>1) 2)</sup>
Mechanically active substances	Conformity with EN 60721-3-3, Class 3S4 including conductive sand, dust <sup>2)</sup>
Air pressure (depending on the highest positive temperature range specified)	1080 ... 795 hPa (-1000 ... +2000 m) see ambient temperature range 795 ... 658 hPa (+2000 ... +3500 m), derating 10 K 658 ... 540 hPa (+3500 ... +5000 m), derating 20 K

1) ISA-S71.04 severity level GX: Long-term load: SO<sub>2</sub> < 4.8 ppm; H<sub>2</sub>S < 9.9 ppm; Cl < 0.2 ppm; HCl < 0.66 ppm; HF < 0.12 ppm; NH < 49 ppm; O<sub>3</sub> < 0.1 ppm; NO<sub>x</sub> < 5.2 ppm  
Limit value (max. 30 min/d): SO<sub>2</sub> < 17.8 ppm; H<sub>2</sub>S < 49.7 ppm; Cl < 1.0 ppm; HCl < 3.3 ppm; HF < 2.4 ppm; NH < 247 ppm; O<sub>3</sub> < 1.0 ppm; NO<sub>x</sub> < 10.4 ppm

2) The supplied plug covers must remain in place over the unused interface when operated in atmospheres containing corrosive gases!

Technical documentation for SIPLUS is available at:

<http://www.siemens.com/siplus-extreme>

#### Design

The sync module is plugged directly into the slot of the CPU 41xH reserved for it. Two Sync modules are required for each CPU. Modules in the subunits are connected by means of fiber-optic connecting cables.

With CPU 414-4H (6ES7 414-4HM14-0AB0) and CPU 417-4H (6ES7 417-4HT14-0AB0) only the following Sync modules and fiber-optic Sync cables can be used:

- Sync module 6ES7 960-1AA04-0XA0 for fiber-optic cables up to 10 m in length (patch cable).
- Sync module 6ES7 960-1AB04-0XA0 for fiber-optic cables up to 10 km in length (patch cable or installation cable).

With CPU 412-3H (6ES7 412-3HJ14-0AB0) only the following Sync module and fiber-optic Sync cable can be used:

- Sync module 6ES7 960-1AA04-0XA0 for fiber-optic cables up to 10 m in length (patch cable).

#### Technical specifications

Order No.	6ES7 960-1AA04-0XA0	6ES7 960-1AB04-0XA0
<b>Current consumption</b> from CPU, max.	210 mA	250 mA
<b>Power losses</b> Power loss, typ.	1.1 mW	1.3 mW
<b>Dimensions, weight</b> Dimensions		
• Width	25 mm	25 mm
• Height	53 mm	53 mm
• Depth	140 mm	140 mm
Weight		
• Weight, approx.	65 g	65 g

#### Selection and ordering data

	Order No.
<b>Sync module</b>	
for coupling the CPU 41xH for S7-400H/F/FH; 2 modules required per CPU	
For 6ES7 412-3HJ14-0AB0, 6ES7 414-4HM14-0AB0 and 6ES7 417-4HT14-0AB0; for patch cable, can be used for fiber-optic cables up to 10 m in length	<b>6ES7 960-1AA04-0XA0</b>
SIPLUS version of above Sync module. Suitable for exceptional medial exposure.	<b>6AG1 960-1AA04-4XA0</b>
For 6ES7 414-4HM14-0AB0 and 6ES7 417-4HT14-0AB0; for patch and installation cables, can be used for fiber-optic cables up to 10 km in length	<b>6ES7 960-1AB04-0XA0</b>
<b>Fiber-optic connecting cable</b>	
For Sync module 6ES7 960-1Ax04-0XA0	
• 1 m	<b>6ES7 960-1AA04-5AA0</b>
• 2 m	<b>6ES7 960-1AA04-5BA0</b>
• 10 m	<b>6ES7 960-1AA04-5KA0</b>
For Sync module 6ES7 960-1AB04-0XA0; fiber-optic monomode LC/LC duplex crossed 9/125 μ (max. 10 km)	<b>on request</b>

# Fault-tolerant automation with SIMATIC CPUs for process automation

## Y-link for S7-400H

### Overview



- Transceiver for the transition from a redundant PROFIBUS DP master system to a single-channel PROFIBUS DP master system
- To connect devices with a single PROFIBUS DP interface to the redundant PROFIBUS DP master system of the SIMATIC S7-400H

### SIPLUS Version

A SIPLUS version of this module is also available.

SIPLUS Y-Link for S7-400H	
Order No.	6AG1 197-1LA11-4XA0
Order No. based on	6ES7 197-1LA11-0XA0
Conformal coating	Coating material of circuit boards and of electronic circuitry in accordance with EN 60721
Technical data	The technical data are identical with those of the based-on module, except for the ambient conditions.
Permitted ambient temperature range	0 ... +60 °C
Permitted relative humidity	5 ... 100 %, condensation is allowed
Biologically active substances	Conformity with EN 60721-3-3, Class 3B2 mold and fungal spores (except fauna)
Chemically active substances	Conformity with EN 60721-3-3, Class 3C4 incl. salt mist and ISA-S71.04 severity level G1; G2; G3; GX <sup>1) 2)</sup>
Mechanically active substances	Conformity with EN 60721-3-3, Class 3S4 including conductive sand, dust <sup>2)</sup>
Air pressure (depending on the highest positive temperature range specified)	1080 ... 795 hPa (-1000 ... +2000 m) see ambient temperature range 795 ... 658 hPa (+2000 ... +3500 m), derating 10 K 658 ... 540 hPa (+3500 ... +5000 m), derating 20 K

1) ISA-S71.04 severity level GX: Long-term load: SO<sub>2</sub> < 4.8 ppm; H<sub>2</sub>S < 9.9 ppm; Cl < 0.2 ppm; HCl < 0.66 ppm; HF < 0.12 ppm; NH < 49 ppm; O<sub>3</sub> < 0.1 ppm; NO<sub>x</sub> < 5.2 ppm  
Limit value (max. 30 min/d): SO<sub>2</sub> < 17.8 ppm; H<sub>2</sub>S < 49.7 ppm; Cl < 1.0 ppm; HCl < 3.3 ppm; HF < 2.4 ppm; NH < 247 ppm; O<sub>3</sub> < 1.0 ppm; NO<sub>x</sub> < 10.4 ppm

2) The supplied plug covers must remain in place over the unused interface when operated in atmospheres containing corrosive gases!

Technical documentation for SIPLUS is available at:

<http://www.siemens.com/siplus-extreme>

### Application

The Y-Link is a transceiver for the transition from a redundant PROFIBUS master system to a single-channel PROFIBUS DP master system. It is used to connect devices with a single PROFIBUS DP interface as switched I/O to S7-400H.

### Design

The Y-Link comprises:

- Two IM 153-2 interface modules
- One Y-Coupler
- One BM IM/IM bus module
- One BM Y-Coupler bus module

Snapped on mounting rails for setup with active bus modules.

### Configuration options and limitations

A redundant PROFIBUS DP master system can be extended by means of Y-Links in the following way:

- The number of Y-Links on a redundant DP master system is only limited by the maximum number of stations. The maximum number of connectable slaves depends on the length of the user data and configuration message frames. The total length of each may not exceed 244 byte (see slave technical specifications). Generally, the following applies:
  - max. 64 stations in the lower-level DP master system
  - max. 236 slots in the lower-level DP master system
- Y-Link configuration and user data message frames comprise message frame contents of the lower-level slaves. Therefore, the maximum message frame length is 244 byte.
- Direct communication and equidistance not possible in the lower-level master system

### Function

#### Y-Link

- Transmission rates for the redundant master system: 9.6 Kbit/s to 12 Mbit/s.
- Bumpless switchover of the redundant PROFIBUS DP master system's active channel.
- Supports system changes on a SIMATIC S7-400H during operation.
- Diagnostics using LEDs and the user program

#### Y-Coupler

- Transmission rates for the lower-level master system (independent of redundant DP master system): 187.5 Kbit/s to 12 Mbit/s.
- Electrical isolation between lower-level DP master system and power supply via the coupler.
- Degree of protection IP20

### Principle of operation

The Y-Link maps the lower-level DP master system on the redundant PROFIBUS DP master system as a switched PROFIBUS DP slave .

The Y-Coupler and the lower-level DP master system form an independent bus system and operate decoupled from the redundant bus system.

The Y-Link as a DP slave on the redundant DP master system acts as a proxy for the stations on the lower-level DP master system with regard to data.

### Configuration

The Y-Link can be configured with STEP 7 as of Version 5.2. It is not necessary to configure the Y-Coupler.



# Fault-tolerant automation with SIMATIC

## CPUs for process automation

### Y-link for S7-400H

When STEP 7 calculates the bus parameters, the stations connected on the lower-level DP master system as well as the Y-Link itself are taken into account.

#### Parameter assignment for the DP slaves

The redundant DP master system assigns the parameters for the DP slaves in the lower-level DP master system via the Y-Link.

#### Technical specifications

IM 153-2 High Feature	6ES7 153-2BA02-0XB0
<b>Power supply</b>	
Input current	
• Rated value at 24 V DC	650 mA
Output voltage	
• Rated value, 5 V DC	Yes
Output current	
• for backplane bus (5 V DC), max.	1.5 A
<b>Supply voltages</b>	
Rated value	
• 24 V DC	Yes
• permissible range (ripple included), lower limit (DC)	20.4 V
• permissible range (ripple included), upper limit (DC)	28.8 V
external protection for supply cables (recommendation)	2.5 A
Mains buffering	
• Mains/voltage failure stored energy time	5 ms
<b>Current consumption</b>	
Current consumption, max.	600 mA
Inrush current, typ.	3 A
$I^2t$	0.1 A <sup>2</sup> ·s
<b>Power losses</b>	
Power loss, typ.	5.5 W
<b>Address area</b>	
Addressing volume	
• Outputs	244 byte
• Inputs	244 byte
<b>Hardware configuration</b>	
Number of modules per DP slave interface, max.	12
<b>Communication functions</b>	
Bus protocol/transmission protocol	PROFIBUS DP to EN 50170
<b>Interfaces</b>	
PROFIBUS DP, output current, max.	70 mA
Interface physics, RS 485	Yes
Interface physics, FOC	No
<b>Connection method</b>	
PROFIBUS DP	9-pin sub D
<b>PROFIBUS DP</b>	
Transmission procedure	RS 485
Transmission rate, max.	12 Mbit/s
Node addresses	1 to 125 permitted
Automatic detection of transmission speed	Yes
SYNC capability	Yes
FREECE capability	Yes
Direct data exchange (slave-to-slave communication)	Yes; Sender
<b>1st interface</b>	
DP slave	
• GSD file	SI04801.GSD

IM 153-2 High Feature	6ES7 153-2BA02-0XB0
• Automatic baud rate search	Yes
<b>programming</b>	
Configuration software	
• STEP 7	Yes; STEP 7 / COM PROFIBUS / non-Siemens tools via GSD file
<b>Time stamping</b>	
Accuracy	1 ms; 1ms at up to 8 modules; 10ms at up to 12 modules
Number of message buffers	15
Messages per message buffer	20
Number of stampable digital inputs, max.	128; max. 128 signals/station; max. 32 signals/slot
Time format	RFC 1119
Time resolution	0.466 ns
Time interval for transmitting the message buffer if a message is present	1 000 ms
Time stamp on signal change	rising / falling edge as signal entering or exiting
<b>Isolation</b>	
Isolation checked with	Isolation voltage 500 V
<b>Environmental requirements</b>	
Operating temperature	
• Min.	0 °C
• max.	60 °C
Air pressure	
• Operating altitude above sea level, max.	3 000 m
<b>Degree of protection</b>	
IP20	Yes
<b>General information</b>	
Vendor identification (VendorID)	801Eh
<b>Dimensions and weight</b>	
Dimensions	
• Width	40 mm
• Height	125 mm
• Depth	117 mm
Weight	
• Weight, approx.	360 g

Y-Coupler	6ES7 197-1LB00-0XA0
<b>Product type designation</b>	
Requirements for DP master system	
• Length of parameter assignment message	244 byte
<b>Supply voltages</b>	
Description	via bus module
Rated value	
• permissible range, lower limit (DC)	20.4 V
• permissible range, upper limit (DC)	28.8 V
<b>Protocols</b>	
PROFIBUS DP protocol	Yes

# Fault-tolerant automation with SIMATIC

## CPUs for process automation

### Y-link for S7-400H

Y-Coupler	6ES7 197-1LB00-0XA0
<b>PROFIBUS DP</b>	
Properties of the lower-level DP master systems	
<ul style="list-style-type: none"> <li>• Transmission rate, max.</li> </ul>	12 Mbit/s; 45.45 Kbit/s to 12 Mbit/s
<ul style="list-style-type: none"> <li>• Termination of lower-level DP master system</li> </ul>	Active terminating resistor (Bus Terminator)
<ul style="list-style-type: none"> <li>• Use of OLM/OBT</li> </ul>	Yes
<ul style="list-style-type: none"> <li>• Use of RS 485 repeaters, max.</li> </ul>	9
<ul style="list-style-type: none"> <li>• Number of DP slaves, max.</li> </ul>	31; 64 when using RS 485 repeaters or OLM/OBT
<b>Interrupts/diagnostics/status information</b>	
Status indicator	No
<b>Alarms</b>	
<ul style="list-style-type: none"> <li>• Alarms</li> </ul>	No
<b>Diagnoses</b>	
<ul style="list-style-type: none"> <li>• Diagnostic functions</li> </ul>	Yes
<b>Galvanic isolation</b>	
to lower-level DP master system	Yes
<b>Dimensions and weight</b>	
Dimensions	
<ul style="list-style-type: none"> <li>• Width</li> </ul>	40 mm
<ul style="list-style-type: none"> <li>• Height</li> </ul>	125 mm
<ul style="list-style-type: none"> <li>• Depth</li> </ul>	130 mm
Weight	
<ul style="list-style-type: none"> <li>• Weight, approx.</li> </ul>	200 g

### Selection and ordering data

	Order No.
For use with STEP 7 from V5.4 or PCS 7 from V7.0:	
<b>Y link for S7-400H</b>	<b>6ES7 197-1LA04-0XA0</b>
For connecting single-channel DP slaves to SIMATIC S7-400H; consisting of 2 IM 153 interface modules (6ES7 153-2BA02-0XB0), 1 Y coupler (6ES7 197-1LB00-0XA0), 1 BM IM/IM bus module (6ES7 195-7HD80-0XA0), 1 BM Y coupler bus module (6ES7 654-7HY00-0XA0)	
For use with PCS 7 V6.0 or higher:	
<b>Y link for S7-400H</b>	<b>6ES7 197-1LA11-0XA0</b>
For connecting single-channel DP slaves to SIMATIC S7-400H; consisting of 2 IM 153 interface modules (6ES7 153-2BA82-0XB0), 1 Y coupler (6ES7 197-1LB00-0XA0), 1 BM IM/IM bus module (6ES7 195-7HD80-0XA0), 1 BM Y coupler bus module (6ES7 654-7HY00-0XA0)	
<b>SIPLUS Y-Link for S7-400H</b>	<b>6AG1 197-1LA11-4XA0</b>
SIPLUS version of above Y-Link module. Suitable for exceptional medial exposure.	
<b>Accessories</b>	
<b>Mounting rail</b>	
For assembling the Y link with active bus modules	
<ul style="list-style-type: none"> <li>• Length 483 mm</li> </ul>	<b>6ES7 195-1GA00-0XA0</b>
<ul style="list-style-type: none"> <li>• Length 530 mm</li> </ul>	<b>6ES7 195-1GF30-0XA0</b>
<b>Bus module for Y-coupler</b>	<b>6ES7 654-7HY00-0XA0</b>
for housing a Y-link, incl. bus module cover	
<b>SIPLUS bus module for Y-coupler</b>	<b>6AG1 654-7HY00-7XA0</b>
for housing a Y-link, incl. bus module cover, suitable for temperatures -25 °C to +70 °C, based on 6ES7 654-7HY00-0XA0	

## Distributed safety software

**Overview**

- For creating safety-oriented automation applications with SIMATIC S7 in LAD or FBD (STEP 7 required)
- Implementation of safety functions by making simple connections between function blocks
- With preconfigured function block library
- User-defined blocks can be created
- Optimum embedding in the automation world due to guaranteed integration with STEP 7 tools
- Scope of supply:
  - Distributed Safety editor
  - Code generator
  - Debugger
  - Libraries of standard blocks

**Benefits**

Technological requirements can be quickly and easily converted into finished executable process automation programs. The outlay for creating programs in LAD or FBD only changes slightly:

- The automation problem can already be solved by configuring. Implementation of the configuring data is made automatically.
- Safety functions are programmed by interconnecting function blocks (AND, OR, etc.). Time-consuming programming is no longer necessary. Of course, FBs created with other STEP 7 programming languages can also be integrated.
- Optimal embedding into the world of automation through guaranteed continuity with the STEP 7 tools (also to the HMI tools), automatic expansion of STEP 7 project management, sharing of signal data with STEP 7, and integration with classical programming languages, e.g. through the import of standard function blocks and FCs written in LAD.
- An executable code is generated virtually at the push of a button and transmitted online into the automation system. To generate codes, STEP 7 needs to be installed on the programming device.

**Application**

The Distributed Safety engineering tool can be used to generate safety-related automation applications with SIMATIC S7 in LAD or FBD. A library of prefabricated blocks is available for this purpose. Users can also program their own blocks and add them to the library.

**Design**

The scope of supply of Distributed Safety includes:

- Distributed Safety editor
- Code generator
- Debugger
- Standard function block libraries

**Function**

- Catalog containing an extensive set of standard blocks, including:
  - Logic blocks
  - Pulse blocks
  - Counter
  - Timers

- Facilitation of test and startup through integral online monitoring and debugging.
- The CPU status is displayed in test mode. The display encompasses the statements online/offline and RUN and STOP online.
- Added documentation options: Linking to project-wide documentation system DOCPRO.
- Message configuring for WinCC.

**Expandable libraries:**

The standard libraries can be expanded by means of separate application/technology-oriented blocks in the STL, LAD, FBD, S7-GRAPH and S7-HiGraph programming languages (for SIMATIC S7 in each case). Blocks can have as many as 160 inputs/outputs.

The F standard libraries can be expanded in the F-LAD and F-FBD programming languages by means of separate application-specific or technology-related blocks. The F blocks are called up and processed in a dedicated F runtime group using the F call function. The maximum interval between two calls can be parameterized in this case.

- Syntax check: To detect program errors already when creating blocks.
- Display and operation attributes optimize the handling of the blocks.

**Test and debug functions**

In test and debug mode, all STEP 7 test functions are available.

**Password protection**

Distributed Safety V5.1 and higher completely supports password protection of the CPU.

**Software requirements**

- Distributed Safety V5.2 runs with STEP 7 V5.1 SP6 and higher.
- Distributed Safety V5.4 runs with STEP 7 V5.3 SP3 and higher.

**Selection and ordering data**

	Order No.
<b>Distributed Safety V5.4 programming tool</b> Task: Software for configuring fail-safe user programs for SIMATIC S7-300F, S7-400F, ET 200S Requirement: STEP 7 V5.3 SP3 and higher Floating license Software Update Service (requires current software version)	<b>6ES7 833-1FC02-0YA5</b> <b>6ES7 833-1FC00-0YX2</b>
<b>Distributed Safety Upgrade</b> From V5.x to V5.4; Floating license for 1 user	<b>6ES7 833-1FC02-0YE5</b>
<b>Single license for "fail-safe function blocks for burner systems" V 5.4</b> License for one controller	<b>9AL3 100-1AD54</b>

# Software for fail-safe/fault-tolerant automation with SIMATIC

## Configuring

### S7 F/FH systems

#### Overview

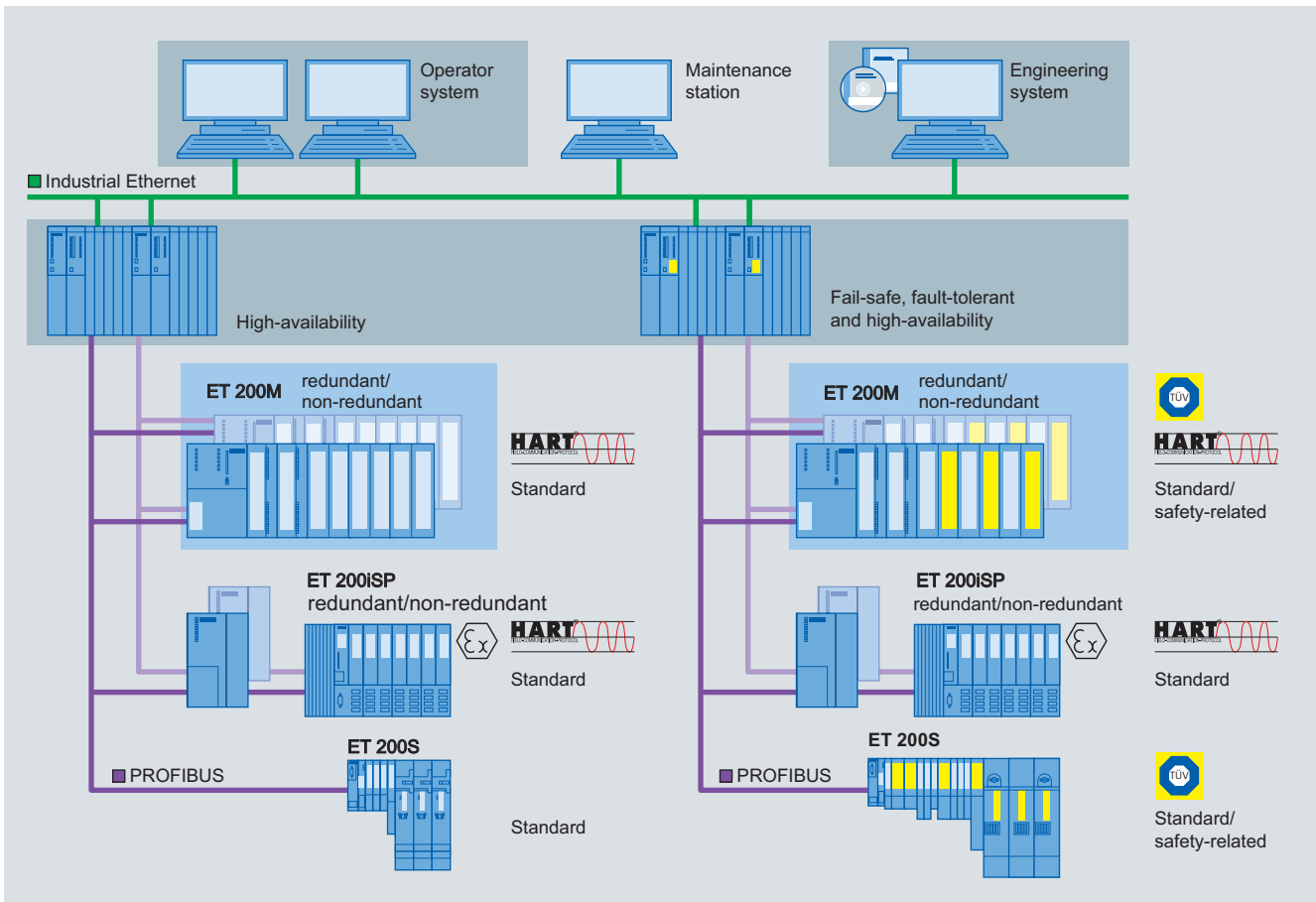

Common engineering system for basic process control system and safety instrumented system

The process industry frequently features complex technological sequences with high safety demands, and faults and failures in the process automation could have fatal consequences for personnel, machines, plants and the environment. Therefore process safety is of particular significance. The safety technology used must reliably detect errors in the process and also its own internal errors, and automatically set the plant/application to a safe state if an error is detected.

S7 F/FH Systems is the comprehensive range of products and services from Siemens for safe, fault-tolerant applications in the process industry. This is characterized by:

- Safe communication via PROFIBUS with PROFIsafe
- Safe communication also via PROFIBUS PA with PROFIsafe
- ET 200 distributed I/O systems with safety-related I/O modules
- User-friendly process visualization, including safety-relevant fault messages, via the optional operator system
- Engineering system with S7 F Systems software package and SIMATIC Safety Matrix
- AS 412F/FH, AS 414F/FH and AS 417F/FH safety-related automation systems. The safety-related automation systems of the S7 F/FH-System are based on the hardware of the CPU 412H, CPU 414H or CPU 417H automation systems that are extended with the S7 F Systems software package to include safety functions. All F/FH systems listed are TÜV-certified and comply with the safety requirements up to SIL 3 according to IEC 61508. There are two design variants:
  - Single-channel (with one CPU, safety-related)
  - High-availability (with redundant CPUs, safety-related and fault-tolerant)

#### Benefits

S7 F/FH Systems permits complete integration of safety engineering into the SIMATIC PCS 7 process control system. The Basic Process Control System (BPCS) and Safety Instrumented System fuse together to form a uniform and innovative complete system. The advantages of this fusion are quite clear:

- One common controller platform
- One common engineering system
- No separate safety bus – standard and safety-related communication take place on the same fieldbus (PROFIBUS with PROFIsafe)
- Mixed operation of standard and safety-related I/O modules in remote I/O stations
- Uniform data management – no complex data exchange between BPCS and safety system
- Integration of safety-related applications into process visualization on the operator station
- Automatic integration of safety-related fault messages with time tagging into the process control system
- Integration of safety-related hardware into the SIMATIC PCS 7 asset management for diagnostics and preventive maintenance

# Software for fail-safe/fault-tolerant automation with SIMATIC

## Configuring

### S7 F/FH systems

Using the S7 F Systems engineering tool, you can parameterize the AS 412F/FH, AS 414F/FH and AS 417F/FH automation systems as well as the safety-related F-modules of the ET 200 I/O systems.

Alternatively, the S7 F Systems engineering tool can also be used with STEP 7 incl. the CFC option package.

Using Continuous Function Charts (CFC) and predefined function blocks from the F-block library of S7 F Systems, you can configure safety-related applications simply, efficiently and without any time-consuming familiarization.

However, this is even simpler, more convenient and faster using the SIMATIC Safety Matrix based on CFC. The configuration tool functioning according to the principle of a Cause&Effect matrix automatically creates complex safety programs once you have assigned the events (causes) occurring during a process to exactly defined reactions (effects).

## Configuring

## S7 F Systems

## Overview

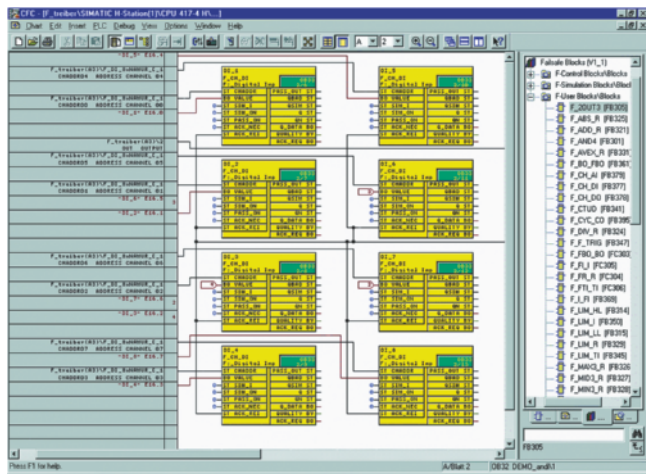

The S7 F Systems engineering tool integrated in the SIMATIC Manager can be used to configure an S7 F/FH System. With this tool you can:

- Parameterize CPU and F-signal modules
- Create safety-related applications in the CFC.

Predefined, TÜV-approved blocks are available for this purpose. The safety-related blocks save the user having to perform redundant programming for detecting and reacting to errors.

## Configuration

S7 F Systems supports configuration by means of functions for

- Comparison of safety-oriented F programs
- Recognition of changes in the F program using the checksum
- Separation of safety-related and standard functions

Access to the F functions can be password-protected.

The F-block library integrated in S7 F Systems contains predefined function blocks for generation of safety-related applications with the CFC or the SIMATIC Safety Matrix based on it. The certified F blocks are extremely robust and intercept programming errors such as division by zero or out-of-range values. They avoid the need for diverse programming tasks for detecting and reacting to errors.

## Selection and ordering data

	Order No.
<b>S7 F Systems RT license</b> For processing safety-related application programs, for one AS 412F/FH, AS 414F/FH or AS 417F/FH	<b>6ES7 833-1CC00-6YX0</b>
<b>S7 F Systems V6.1</b> Programming and configuring environment for creating and operating safety-related STEP 7 programs for an S7 400H-based target system, floating license for 1 user, executable under Windows XP Prof SP2/SP3, Windows Server 2003 SP2 2 languages (German, English) Type of supply: Certificate of license as well as software and electronic documentation on CD	<b>6ES7 833-1CC02-0YA5</b>
<b>S7 F systems upgrade from V5.x/V6.0 to V6.1</b> 2 languages (German, English), floating license for 1 user Type of supply: Certificate of license as well as software and electronic documentation on CD	<b>6ES7 833-1CC02-0YE5</b>

## Note:

In the case of an S7 F Systems Upgrade from V5.x to V6.1, the type of S7 F Systems license changes from single license to floating license.

## Options

When using the safety-related SM 326F/336F I/O modules (AI, DI, DO) as standard I/Os (without F-functionality), an S7 F ConfigurationPack is required for engineering. This is included in S7 F Systems V6.0 and is also available in the Internet for downloading.

Additional information is available in the Internet under:

<http://support.automation.siemens.com/WW/view/en/15208817>

## Overview

Input Tag	Func	Limit/Trip	EngUnit	Cause Description	Action	1	2	3	4	5	6	7	8	9	10	11	12	13	14
PS_100		FALSE		Feed Pump High Pressure Switch	Shut down	1	N												
LSL_100		TRUE		Tank_100 Level switch high	Shut down	2	S	S	R				2N						
LSL_200		TRUE		Hopper_200 Level switch Low	Shut down	3	N	N											
PSH_200		TRUE		Hopper_200 High Pressure	Shut down	4	N	N											
PT_100		H 35.00	PSIG	Feed pressure	Shut down	5	S	S	S										
ILT_100		H 50.00	Feet	Tank Level	Shut down	6	S	S	N				2N						
PT_101		H 25.00		Tank Pressure	Shut down	7													
PT_102	Vote	D 3.0	in_H20	Tank Pressure	Shut down														
PT_103					Shut down														
ILT_200		H 50.00	ft	Hopper Level	Shut down	8													
TS_101		FALSE			Shut down														
TS_102	AND	FALSE		Tank_100 High Temperature switch	Shut down	9													
TS_103		FALSE			Shut down														

The SIMATIC Safety Matrix which can be used in addition to the CFC is an innovative safety lifecycle tool from Siemens that can be used not only for user-friendly configuration of safety applications, but also for their operation and service. The tool, which is based on the proven principle of a cause & effect matrix, is ideally suited to processes where defined statuses require specific safety reactions.

## System requirements

	Hardware requirement	Software requirement
SIMATIC Safety Matrix Tool	Automation system 412F/FH, 414F/FH or 417F/FH	<ul style="list-style-type: none"> <li>• S7 F Systems V5.2 SP1 or higher</li> <li>• F-library Fail-safe Blocks (V1.2) or S7 F Systems Lib V1.3</li> </ul>
SIMATIC Safety Matrix Editor		<ul style="list-style-type: none"> <li>• Windows XP SP2 or SP3</li> <li>• Windows 2003 Server SP1 or SP2</li> </ul>
SIMATIC Safety Matrix Viewer	Automation system 412F/FH, 414F/FH or 417F/FH	<ul style="list-style-type: none"> <li>• PCS 7 V6.1 SP3, or</li> <li>• PCS 7 V7.0 SP3 or higher or</li> <li>• PCS 7 V7.1 HF1 or higher</li> </ul>

The SIMATIC Safety Matrix Editor offers the advantage that the Safety Matrix can also be created, processed further and debugged outside the SIMATIC PCS 7 engineering system. The SIMATIC Safety Matrix Editor can be used on a computer with Windows 2000 Professional SP2 or higher or Windows XP Professional. However, generation of the safety-related CFC program as well as compilation and downloading to the automation system are only possible by means of the SIMATIC engineering system with the SIMATIC Safety Matrix Tool.

The SIMATIC Safety Matrix not only means that programming of the safety logic is significantly simpler and more convenient, but also much faster than in the conventional manner. During the risk analysis of a plant, the configuration engineer can assign exactly defined reactions (effects) to events (causes) which may occur during a process.

## Benefits

The advantages of the SIMATIC Safety Matrix in the implementation phase:

- Simple programming using Cause&Effect method
- No programming knowledge required
- Automatic generation of CFCs including driver blocks
- Automatic version tracking
- Integrated change tracking
- 1-to-1 printout of Cause&Effect matrix

## Design

In the context of SIMATIC PCS 7, the following individual products are offered for the SIMATIC Safety Matrix:

- SIMATIC Safety Matrix Tool for configuration of safety functions on the SIMATIC PCS 7 engineering system
- SIMATIC Safety Matrix Editor for creating and debugging the Safety Matrix logic in an external computer, independent of the engineering system (can be optionally used additive to the SIMATIC Safety Matrix Tool)
- SIMATIC Safety Matrix Viewer for SIMATIC PCS 7 for operation and monitoring of the SIMATIC Safety Matrix using the SIMATIC PCS 7 operator system

# Software for fail-safe/fault-tolerant automation with SIMATIC

## Configuring

### SIMATIC Safety Matrix

#### Function

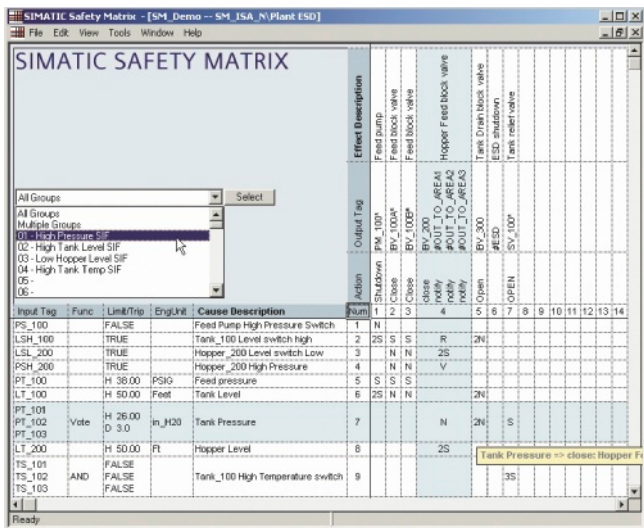

Safety Matrix: intersections define the linking of causes and effects

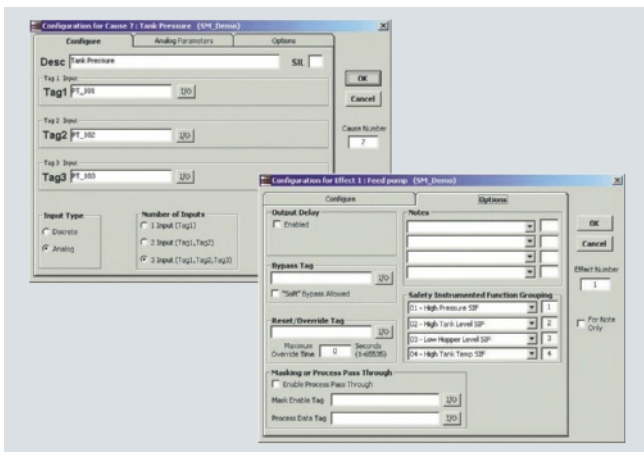

Configuration of analog or digital causes and their digital effects

The matrix table is comparable with a spreadsheet program, and the configuration engineer first enters the possible process events (inputs) in the horizontal lines, and then configures their type and number, logical links, possible delays and interlocks, and any tolerable faults. In the vertical columns, he subsequently defines the reactions (outputs) to a particular event.

Events and reactions are linked simply by clicking the cell at the intersection of the row and column. Using these data, the SIMATIC Safety Matrix automatically generates complex, safety-related CFC programs. No special programming knowledge is required of the configuration engineer, and he can completely concentrate on the safety requirements of the plant.

#### Selection and ordering data

	Order No.
<p><b>SIMATIC Safety Matrix Tool V6.2</b>                      Creation, configuration, compilation, loading and online monitoring of the Safety Matrix in a SIMATIC PCS 7 environment                      Including SIMATIC Safety Matrix Viewer for SIMATIC PCS 7, for operation and monitoring of the Safety Matrix in a SIMATIC PCS 7 environment with several operator control levels                      1 language (English), executes with Windows XP Professional,                      Type of supply: Certificate of License and authorization diskette for Safety Matrix Tool and Safety Matrix Viewer; software and electronic documentation on CD</p> <p>Floating License for 1 installation                      Floating License upgrade from V5.x/V6.x to V6.2</p>	<p><b>6ES7 833-1SM02-0YA5</b>  <b>6ES7 833-1SM02-0YE5</b></p>
<p><b>SIMATIC Safety Matrix Editor V6.2</b>                      Creation and checking of the Safety Matrix logic on an external computer without a SIMATIC PCS 7 or STEP 7 environment                      1 language (English), executes with Windows 2000 Professional or Windows XP Professional, single license for 1 installation                      Type of supply: Certificate of License and authorization diskette; software and electronic documentation on CD</p>	<p><b>6ES7 833-1SM42-0YA5</b></p>
<p><b>SIMATIC Safety Matrix Viewer V6.2 for SIMATIC PCS 7</b>                      Operation and monitoring of the Safety Matrix in the SIMATIC PCS 7 environment with several operating levels                      Bilingual (English/German), runs on Windows 2000 Professional or Windows XP Professional, Windows 2003 Server                      Type of supply: Certificate of License and authorization diskette; software and electronic documentation on CD</p> <p>Floating License for 1 installation                      Floating License upgrade from V6.x to V6.2</p>	<p><b>6ES7 833-1SM62-0YA5</b>  <b>6ES7 833-1SM62-0YE5</b></p>

3



## Overview

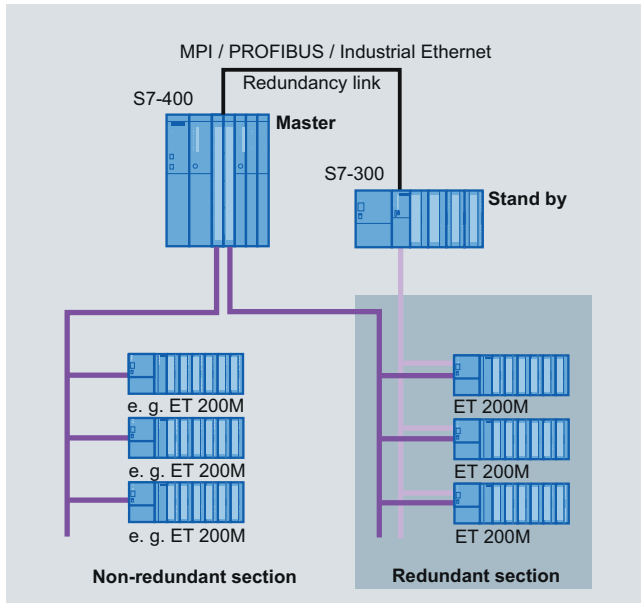

- Software package for assembling fault-tolerant control systems based on software
- Designed for control systems with single-channel distributed I/O
- For use in applications with low demands on changeover speed, such as the control of hydroelectric power plants, cooling circuits, traffic flows, level control, measured data acquisition
- Inexpensive thanks to the use of standard S7-300 and S7-400 components
- I/O linking with PROFIBUS DP in redundant configuration
- Optional control via WinCC operator station

## Application

With the "Software Redundancy" software package, fault-tolerant control systems can be assembled at low cost with standard hardware components of the S7-300 and S7-400.

Software redundancy can be used for applications which do not make high demands for changeover speed, such as:

- Control of waterworks or water treatment plants
- Control of cooling circuits
- Monitoring and control of traffic flows
- Monitoring/control of temperature or levels

Depending on the application, the entire process or only parts of it can be redundantly designed.

The following failures are controlled:

- The failure of redundant components (PROFIBUS DP master interface, power supply) in a central controller
- The failure of a CPU on account of hardware faults or software errors
- Interruption of the redundancy link between both central controllers
- Interruption of one of the redundant PROFIBUS DP links to distributed I/O

## Design

A control system with redundancy is assembled as follows using the Software Redundancy package:

- Two S7-300 (CPU 313C-2 DP, CPU 314C-2 DP, CPU 315-2 DP, CPU 316-2 DP, CPU 318-2 DP or higher) or S7-400 (master and reserve, all CPUs) central controllers, can also be used in combination.  
User program and software redundancy program package on both devices
- Single-channel distributed I/O, switched, comprising ET 200M distributed I/O devices with two IM 153-2
- Redundant linking of the central controllers:  
Via MPI, PROFIBUS DP or Industrial Ethernet; existing communication links can be used.
- Optional:  
Non-redundant I/O, central or distributed
- Optional:  
WinCC operator station for user-friendly operator control and monitoring of the redundancy functions (WinCC picture block included in the supply)

## Function

### Software redundancy:

- Automatic switchover from failed central controller (master) to standby central controller.

### Operation with WinCC operator station:

- Request switchover
- Switch redundancy on/off (activate/disable switchover)
- Display status of redundant coupling
- Display status of ET 200M slaves

### Mode of operation

In the event of a fault, the "software redundancy" package initiates a switchover from the master central controller to the standby:

- During switchover:  
No effect on process since the controller outputs remain frozen
- Following switchover:  
Continuation of process based on last data received. Data may be several cycles old, therefore only useable for slower processes.

The switchover time between failure of the master and continuation of the process on the standby controller depends on several factors:

- Communication performance of the CPUs used
- Communication medium for master/standby coupling, type of connection and transmission rate
- Quantity of data to be transmitted
- Cause of fault
- Transmission rate of redundant PROFIBUS DP
- Number of slaves on the redundant PROFIBUS DP

For example, the following switchover times result for a system comprising two 414-2 DP CPUs and four ET 200 stations with 4 KB data to be transmitted:

- If the CPUs are coupled via PROFIBUS DP: 1.2 s.
- If the CPUs are coupled via MPI: 1.5 s.

# Software for fail-safe/fault-tolerant automation with SIMATIC

## Configuring

### Software redundancy

#### Technical specifications

Software redundancy	
<b>Hardware requirements</b>	
CPU	S7-300: CPU 313C-2 DP, 314C-2 DP, 315-2 DP, 316-2 DP, 318-2 DP S7-400: all CPUs
Redundancy link of the CPUs	MPI, PROFIBUS, Industrial Ethernet; existing connections can also be used.
Suitable modules for ET 200M	IM 153-2; all DI/O, AI/O for ET 200M; FM 350-1 counter module CP 341
<b>Software requirements</b>	
Configuring/programming	STEP 7 V4.0
Communication configuration for redundant PROFIBUS DP	NCM S7 for PROFIBUS

#### Selection and ordering data

	Order No.
<b>Program package software redundancy V1.2</b>	
Task: Configuring a redundant control. Target system: SIMATIC S7-300, S7-400 Requirement: STEP 7 V5.2, NCM S7 for PROFIBUS Delivery package: incl. electronic documentation (English, German, French, Spanish, Italian), 4 application examples and faceplate for WinCC on CD-ROM	
Single license (for 2 CPUs)	<b>6ES7 862-0AC01-0YA0</b>
Single license, without software and documentation	<b>6ES7 862-0AC01-0YA1</b>
<b>SIMATIC Manual Collection</b>	<b>6ES7 998-8XC01-8YE0</b>
Electronic manuals on DVD, multilingual: LOGO!, SIMADYN, SIMATIC bus components, SIMATIC C7, SIMATIC distributed I/O, SIMATIC HMI, SIMATIC Sensors, SIMATIC NET, SIMATIC PC Based Automation, SIMATIC PCS 7, SIMATIC PG/PC, SIMATIC S7, SIMATIC Software, SIMATIC TDC	
<b>SIMATIC Manual Collection update service for 1 year</b>	<b>6ES7 998-8XC01-8YE2</b>
Current "Manual Collection" DVD and the three subsequent updates	

3

## Overview



- SIMATIC WinAC RTX F: Optimized for applications that demand a high degree of flexibility and integration capability and that must also satisfy safety requirements up to SIL 3 (IEC 61508).
- The software solution for tasks that require hard deterministic behavior and high performance.
- With real-time expansion for assuring deterministic behavior for the control section.
- Distributed I/O can be connected over PROFIBUS and/or PROFINET, also safety-related over PROFIsafe.

## Benefits

- Hard real-time and maximum performance up to SIL 3 according to IEC 61508/62061 or according to EN ISO 13849-1 up to PL e
- Implementation of fast, S7-compatible control solutions with low processor loading. Alongside the control task, sufficient processor capability is available for processing complex, demanding PC applications in parallel.

## Application

WinAC RTX F is a fail-safe software controller approved by the German Technical Inspectorate for standard and safety-related applications. The STEP 7 option package "S7 Distributed Safety" is used for programming the safety-related (F) program part. SIMATIC WinAC RTX F is particularly suited to tasks requiring a high level of flexibility and effective integration in the overall solution. This also includes close interlinking with data processing systems or logistics systems and integration in the safety control.

WinAC RTX F is equally suited to implementation on cost-effective PC platforms with single-core processors and on high-end PCs, e.g. with QuadCore processors. WinAC RTX F is optimized for operation on embedded PC platforms such as the S7-modular Embedded Controller, the SIMATIC IPC427C, or the SIMATIC HMI IPC477C. These platforms offer, with their diskless and fanless design, significantly enhanced ruggedness for an automation task. Non-volatile memory is also available which permits storage of up to 512 KB retentive data (S7-mEX, EC31) on a voltage dip, independently of the file system. The I/O is connected via the leading fieldbus standards of PROFINET or PROFIBUS. With the S7-mEC, EC31, operation is also possible with the central signal modules (SM) of S7-300. The support of the integral PROFINET or PROFIBUS interfaces of the SIMATIC IPCs, as well as the excellent performance result in an excellent price/performance ratio for the PC-based automation.

The WinAC ODK is used for expansion of the PLC functionality with application specific C/C++ applications. In the standard program part, it supports:

- Integration of complex high-level language algorithms in the control program
  - Access to the Windows API or Windows system resources
  - Access to external HW and software components
- Read-only access is permitted in the safety program part.

## Design

SIMATIC WinAC RTX F comprises the following components:

- Windows Fail-safe Logic Controller (WinLC RTX F V4.6)
- WinAC TimeSynchronization
- SIMATIC NET SOFTNET-S7 Lean
- Real-time driver for PROFINET and PROFIBUS interfaces
- IntervalZero RTX real-time core for ensuring real-time and a deterministic response

Optional:

- Interfaces for connection to PROFIBUS DP:
  - CP 5611 A2 or the integral PROFIBUS interface of the SIMATIC IPC
  - CP 5621
  - CP 5613 A2
  - CP 5603
  - CP 5623
- Interfaces for connection to PROFINET:
  - CP 1616 (HW version 8 and above) or integral CP 161 onboard interface of the SIMATIC IPC
  - CP 1604 (HW version 7 and above)
  - Integral CP 1616 onboard interfaces of the SIMATIC IPC
  - Integrated standard Ethernet interfaces of selected SIMATIC IPCs (e.g. SIMATIC IPC427C and HMI IPC477C)
- WinAC Open Development Kit (ODK):
  - For integrating C/C++ code in WinAC RTX
  - Integration of external software (technology programs) or PC components (e.g. barcode scanner, PC cards for measured value acquisition)

## Function

### Windows Fail-safe Logic Controller (WinLC RTX F)

The Windows Fail-safe Logic Controller is responsible for the actual control job and execution of the control program. It coordinates the associated input and output of process values via the lower-level PROFINET or PROFIBUS fieldbus system and makes the process values available for visualization and data processing tasks.

Fail-safe programs are created with the STEP 7 option package S7 Distributed Safety.

A safety control can be built up using fail-safe signal modules. This opens up

- Classical safety applications in the field of machine safety and press automation as well as
- Applications in process engineering and chemicals.

The I/O can be connected over PROFINET IO or PROFIBUS DP. The PROFIsafe profile supports fail-safe communication over the fieldbuses for this purpose.

The functional safety is implemented by means of targeted safety functions in the software. Safety functions are implemented with S7 Distributed Safety, to place the plant in a safe state or to hold it in a safe state. The safety functions are mainly contained within the following components:

- In the safety-related user program (safety program) in WinLC RTX F
- In the fail-safe inputs and outputs (F I/O).

The F I/O ensures safety-related processing of the field information (emergency stop pushbutton, light barriers, motor pre-control). It features all the hardware and software components

# PC-based Control

## SIMATIC WinAC RTX F

required for reliable processing, according to the required safety class.

The user only programs the user safety functions. The safety functions for the process can be implemented with a user safety function or a system-internal fault reaction function. If the F system is unable to execute the actual user safety function, it will execute the fault response function: e.g. deactivation of the associated outputs and, if appropriate, F-CPU in STOP.

Also see [www.siemens.com/simatic-winac](http://www.siemens.com/simatic-winac)

### Interface to visualization

SIMATIC WinAC RTX F is easy to use with the SIMATIC HMI systems SIMATIC WinCC flexible or SIMATIC WinCC.

Visualization systems from third-party suppliers can be connected via the included SIMATIC NET OPC server.

### Communication

The programming of the Windows Logic Controller with STEP 7 and also the visualization with SIMATIC HMI can be implemented both locally in the same PC and remotely using the standard SIMATIC networks Ethernet or PROFIBUS.

WinAC RTX F can exchange data via these networks:

- With additional WinAC stations
- With S7 controllers as well as
- With safety-oriented S7 controllers (safe PLC-to-PLC communication)

A SOFTNET S7 Lean license is included for Industrial Ethernet communication over the integral Ethernet interfaces of the SIMATIC PC.

### Technical specifications

Order No.	6ES7 671-1RC08-0YA0
<b>Product type designation</b>	SIMATIC WinAC RTX F 2010
<b>Product version</b>	
Hardware product version	-
Firmware version	V4.6
associated programming package	STEP7 as of V5.5 + HW update / iMap V3.0 SP1 / option package S7 Distributed Safety V5.4 + SP5 / S7 F Configuration Pack V5.5 + SP6 + HF1
<b>Main Memory</b>	
• integrated (for program)	4 Mbyte; Adjustable; depends on Non Paged Memory Pool
• integrated (for data)	4 Mbyte; Adjustable; depends on Non Paged Memory Pool
<b>Isochronous mode</b>	
Isochronous mode	Yes
<b>Hardware requirements</b>	
Hardware required	PC with color monitor, keyboard, mouse or pointing device for Windows
Required memory on hard disk	min. 100 Mbyte
Main memory, min.	1 Gbyte
Processor	Intel Celeron M 900 MHz or compatible (older PC systems with Programmable Interrupt Controllers (PIC) are not suitable for WinAC RTX F 2010.)
• Multi-processor system	No
• Hyper-threading	Yes
<b>Operating systems</b>	
• Windows NT 4.0	No
• Windows 2000	No
• Windows XP	Yes; Professional, SP2 and SP3
• Windows XP embedded	Yes; With the delivery image of the SIMATIC PC

Order No.	6ES7 671-1RC08-0YA0
- Supported HAL types under Windows XP	ACPI uniprocessor PC, ACPI multi-processor PC, MPS multiprocessor PC
• Windows embedded Standard 7	No
• Windows 7	Yes; Professional, Enterprise, Ultimate (only 32 bits)
• Windows Vista	No
<b>Dimensions and weight</b>	
Weight	
• Weight, approx.	100 g; with packaging

### Selection and ordering data

	Order No.
<b>SIMATIC WinAC RTX F 2010</b>	<b>6ES7 671-1RC08-0YA0</b>
<b>SIMATIC WinAC RTX F 2010 upgrade</b>	<b>6ES7 671-1RC08-0YE0</b>
<b>CP 5611 A2 communications processor</b>	<b>6GK1 561-1AA01</b>
PCI card (32 bit) for connection of a programming device or PC to PROFIBUS	
<b>CP 5621 communications processor</b>	
PCI Express x1 card (32 bit) for connection of a programming device or PC to PROFIBUS	<b>6GK1 562-1AA00</b>
PCI Express x1 card (32 bit) CP 5621 and MPI cable, 5 m	<b>6GK1 562-1AM00</b>
<b>CP 5603 Microbox Package</b>	<b>6GK1 560-3AU00</b>
Comprising CP 5603 module and Microbox expansion rack	
<b>CP 5613 A2 communications processor</b>	<b>6GK1 561-3AA01</b>
PCI card (32 bit; 3.3 V/5 V) for connection to PROFIBUS incl. DP-Base software with NCM PC; DP-RAM interface for DP master, incl. PG and FDL protocol; single license for 1 installation, runtime software, software and electronic manual on CD-ROM, Class A, for 32 bit Windows 2000 Professional/Server, Windows XP Professional, German/English	
<b>CP 5623 communications processor</b>	<b>6GK1 562-3AA00</b>
PCI Express x1 card (32 bit) for connection to PROFIBUS incl. DP-Base software with NCM PC; DP-RAM interface for DP master or DP slave, incl. PG and FDL protocols; single license for 1 installation, runtime software, software and electronic manual on CD-ROM, Class A, for operating system support see SIMATIC NET software; German/English	
<b>CP 1616 communications processor</b>	<b>6GK1 161-6AA01</b>
PCI Card (32 bit; 3.3/5 V universal key) with ASIC ERTEC 400 for connecting PCs to PROFINET IO with 4-port real-time switch (RJ45); incl. IO-Base software for PROFINET IO controller (RT operation) and NCM PC; single license for one installation, runtime software, software and electronic manual on CD-ROM, Class A, for 32 bit Windows XP Professional; German/English	
<b>CP 1604 Microbox Package</b>	<b>6GK1 160-4AU00</b>
Package for implementing the CP 1604 in the SIMATIC Microbox PC; comprising the CP 1604, connection board, power supply and expansion rack for Microbox PC; for use with Development Kit DK-16xx PN IO; NCM PC	

# SIMATIC ET 200 fail-safe distributed IO

## SIMATIC ET 200S - Interface modules with integrated CPU

IM 151-7 F-CPU

### Overview



- Interface module with integrated fail-safe CPU for SIMATIC ET 200S
- With DP/MPI interface
- For design of a fail-safe automation system for plants with increased safety requirements
- Complies with safety requirements up to SIL 3 according to IEC 61508, IEC 62061 and Cat. 4 according to EN 954-1
- Fail-safe I/O modules can be connected in a distributed configuration through DP master modules (PROFIsafe)
- The fail-safe I/O modules of ET200S PROFIsafe can be connected in a centralized configuration
- Standard modules can be used for non-safety-relevant applications

Note:  
Micro Memory Card required for operation of CPU.

#### SIPLUS Version

A SIPLUS version of this module is also available.

SIPLUS IM 151-7 F-CPU interface module	
Order No.	6AG1 151-7FA20-2AB0
Order No. based on	6ES7 151-7FA20-0AB0
Permitted ambient temperature	-25 ... +60 °C
Permitted relative humidity	5 ... 100 %, condensation is allowed
Conformal coating	Coating material of circuit boards and of electronic circuitry
Technical data	The technical data are identical with those of the based-on module, except for the ambient conditions.

Technical documentation for SIPLUS is available at:  
<http://www.siemens.com/siplus-extreme>

### Application

- The IM 151-7 F-CPU supports setting up a fail-safe automation system for plant with stringent safety requirements, particularly in production engineering.
- The intelligent ET 200S station can also be implemented standalone.
- As a PROFIBUS DP slave they can be used for distributed, fail-safe expansion of both the fail-safe and the standard versions of PROFIBUS DP masters.

### Design

The CPU IM 151-7 F is equipped with the following:

- Microprocessor; execution time 100 ns per binary instruction
- 128 KB RAM
- Bit-modular expandability for maximum flexibility; up to 63 I/O modules (power, electronic, technology, and motor starter modules) in any combination
- Integrated multi-port interface PG, OP/DP, in RS 485 (Cu, 9-pin Sub-D socket), configurable as DP slave or MPI
- Password concept protects the user program from unauthorized access
- Diagnostics buffer for the last 100 errors and interrupt events
- SIMATIC MMC
  - For maintenance-free data backup without battery
  - Program backup (load memory)
  - Firmware update using MMC
  - External load memory on MMC
- Update using MMC
- Hardware clock; date and time can be appended to diagnostic messages of the CPU
- Integrated communications functions:
  - PG/OP communication
  - PROFIBUS DP slave/MPI
- Basic communication as server (access from S7-CPU's via PROFIBUS with I-Put/I-Get to IM 151-7 F CPU data)
- TeleService

### Function

#### Configurable and parameterizable attributes

- I/O configuration: Type and scope
- Startup and scan cycle response: Definition of maximum scan time and loading, in addition to self-test functions
- Definition of the number of retentive bit memories, counters, timers and data blocks
- Clock memory flag: Address settings
- Protective stage: Definition of access authorizations to programs and data
- Definition of the handling and scope of diagnostic messages
- Timed interrupts: Setting of periodic occurrence
- Schedulers: Start date, start time and periodicity settings

#### Mode of operation

The safety functions of the IM 151-7 F-CPU are present in the F program of the CPU and in the fail-safe signal modules. The signal modules monitor the output and input signals by means of discrepancy analyses and test signal injections.

The CPU checks proper operation of the PLC by performing regular self-tests, instruction tests and logic and sequential program flow control. In addition, the I/O is checked by requesting signs of life.

If an error is diagnosed on the system, the latter is moved to a safe state.

An F runtime license is not required for operation of the IM 151-7 F-CPU.

# SIMATIC ET 200 fail-safe distributed IO

## SIMATIC ET 200S - Interface modules with integrated CPU

### IM 151-7 F-CPU

#### Display and information functions

- Status and error functions; LEDs indicate, for example, hardware, programming, time or I/O errors and the modes RUN, STOP, restart, etc.
- Test functions; the PG can be used to display signal states in program execution, modify process tags irrespective of the user program, and read out the contents of stack memories
- Information functions; you can use the PG to obtain information about the storage capacity and operating mode of the CPU as well as the current loading of work and load memories, current scan times and diagnostic buffer contents in plaintext

#### Programming

The IM 151-7 F-CPU is programmed in the same manner as the other SIMATIC S7 systems. The user program for non-fail-safe plant sections is created with the proven programming tools such as STEP 7.

#### SIMATIC S7 Distributed Safety option package

The STEP 7 option package "SIMATIC S7 Distributed Safety" is required to program the safety-relevant parts of the program. The package contains all the functions and blocks required to create the F program.

The F program with the safety functions is linked in the F-FBD or F-LAD or using special function blocks from the F library. Use of F-FBD or F-LAD simplifies plant planning and programming and, because of the uniform and cross-vendor presentation, the acceptance test. Programmers can concentrate completely on configuration of the safety-relevant application without having to use additional tools.

#### Technical specifications

Order no.	6ES7 151-7FA20-0AB0
<b>Product version</b>	
associated programming package	STEP 7 V5.2 + SP1 or higher with HW update
<b>Supply voltages</b>	
Load voltage L+	
• Rated value (DC)	24 V
• permissible range, lower limit (DC)	20.4 V
• permissible range, upper limit (DC)	28.8 V
• Short-circuit protection	Yes
• Reverse polarity protection	Yes
<b>Current consumption</b>	
Current output to backplane bus (DC 5 V), max.	700 mA
from supply voltage 1L+, max.	250 mA; 280 mA with DP master module
<b>Power losses</b>	
Power loss, typ.	3.3 W
<b>Memory</b>	
Work memory	
• integrated	128 Kbyte; for program and data
• expandable	No
Load memory	
• pluggable (MMC)	Yes
• pluggable (MMC), max.	8 Mbyte
<b>CPU-blocks</b>	
Number of blocks (total)	1 024; (DBs, FCs, FBs); the maximum number of loadable blocks can be reduced by the MMC used.
DB	
• Number, max.	511; Number range: 1 to 511
• Size, max.	16 Kbyte

Order no.	6ES7 151-7FA20-0AB0
FB	
• Number, max.	1 024; Number range: 0 to 2047
• Size, max.	16 Kbyte
FC	
• Number, max.	1 024; Number range: 0 to 2047
• Size, max.	16 Kbyte
OB	
• Size, max.	16 Kbyte
Nesting depth	
• per priority class	8
• additional within an error OB	4
<b>CPU processing times</b>	
for bit operations, min.	0.1 µs
for word operations, min.	0.2 µs
for fixed point arithmetic, min.	2 µs
for floating point arithmetic, min.	3 µs
<b>Counters, timers and their retentivity</b>	
S7 counter	
• Number	256
• Retentivity	
- can be set	Yes
- lower limit	0
- upper limit	255
- preset	Z 0 to Z 7
• Counting range	
- can be set	Yes
- lower limit	0
- upper limit	999
IEC counter	
• Type	SFB
• Number	Unlimited (limited only by RAM capacity)
S7 times	
• Number	256
• Retentivity	
- can be set	Yes
- lower limit	0
- upper limit	255
- preset	No retentivity
• Time range	
- lower limit	10 ms
- upper limit	9 990 s
IEC timer	
• Type	SFB
• Number	Unlimited (limited only by RAM capacity)
<b>Data areas and their retentivity</b>	
retentive data area in total (incl. times, counters, flags), max.	64 Kbyte
Flag	
• Number, max.	256 byte
• Retentivity available	Yes
• Retentivity preset	MB 0 to MB 15
• Number of clock memories	8; 1 memory byte
Data blocks	
• Number, max.	511; Number range: 1 to 511
• Size, max.	16 Kbyte
Local data	
• per priority class, max.	510 byte

# SIMATIC ET 200 fail-safe distributed IO

## SIMATIC ET 200S - Interface modules with integrated CPU

IM 151-7 F-CPU

Order no.	6ES7 151-7FA20-0AB0
<b>Address area</b>	
I/O address area	
• overall	2 048 byte
• Outputs	2 048 byte
<b>Process image</b>	
• Inputs	128 byte; Not adjustable
• Outputs	128 byte; Not adjustable
<b>Digital channels</b>	
• Inputs	16 336
• Outputs	16 336
• Inputs, of which central	248
• Outputs, of which central	248
<b>Analog channels</b>	
• Inputs	1 021
• Outputs	1 021
• Inputs, of which central	124
• Outputs, of which central	124
<b>Hardware configuration</b>	
Number of modules per system, max.	63; Centralized
<b>Time of day</b>	
Clock	
• Hardware clock (real-time clock)	Yes
• battery-backed and synchronizable	Yes
• Backup time	6 wk; At 40 °C ambient temperature, typically
• Deviation per day, max.	10 s
<b>Runtime meter</b>	
• Number	1
• Number/Number range	0
• Range of values	0 to 2 <sup>31</sup> hours (when using SFC 101)
• Granularity	1 hour
• retentive	Yes; must be restarted at each restart
<b>Clock synchronization</b>	
• supported	Yes
• to MPI, master	Yes
• to MPI, slave	Yes
• in AS, master	No
• in AS, slave	No
<b>S7 message functions</b>	
Number of login stations for message functions, max.	12; Depending on the configured connections for PG/OP and S7 basic communication
<b>Process diagnostic messages</b>	
	Yes; ALARM_S, ALARM_SC, ALARM_SQ, ALARM_D, ALARM_DQ
simultaneously active Alarm-S blocks, max.	40
<b>Test commissioning functions</b>	
Status/control	
• Status/control variable	Yes
• Variables	Inputs, outputs, memory bits, DB, times, counters
• Number of variables, max.	30
• of which status variables, max.	30
• of which control variables, max.	14
<b>Forcing</b>	
• Forcing	Yes
<b>Status block</b>	
	Yes
<b>Single step</b>	
	Yes
<b>Number of breakpoints</b>	
	2

Order no.	6ES7 151-7FA20-0AB0
<b>Diagnostic buffer</b>	
• present	Yes
• Number of entries, max.	100
- can be set	No
<b>Communication functions</b>	
PG/OP communication	Yes
<b>Global data communication</b>	
• supported	Yes
• Number of GD packets, max.	4
• Number of GD packets, transmitter, max.	4
• Number of GD packets, receiver, max.	4
• Size of GD packets, max.	22 byte
• Size of GD packet (of which consistent), max.	22 byte
<b>S7 basic communication</b>	
• supported	Yes
• User data per job, max.	76 byte
• User data per job (of which consistent), max.	76 byte; 76 bytes (with X_SEND or X_RCV); 64 bytes (with X_PUT or X_GET as server)
<b>S7 communication</b>	
• supported	Yes
• as server	Yes
• as client	No
• User data per job, max.	180 byte
• User data per job (of which consistent), max.	64 byte
<b>S5-compatible communication</b>	
• supported	No
<b>Standard communication (FMS)</b>	
• supported	No
<b>Number of connections</b>	
• overall	12
• usable for PG communication	11
- reserved for PG communication	1
• usable for OP communication	11
- reserved for OP communication	1
• usable for S7 basic communication	10
- Reserved for S7 basic communication	0
• usable for routing	4; As slave only with active interface, with IM 151-7 CPU as DP master
<b>1st interface</b>	
Type of interface	Integrated RS 485 interface
<b>Physics</b>	
	RS 485
<b>Isolated</b>	
	Yes
<b>Power supply to interface (15 to 30 V DC), max.</b>	
	80 mA
<b>Functionality</b>	
• MPI	Yes
• DP master	No
• DP slave	Yes; active / passive
• Point-to-point connection	No
<b>MPI</b>	
• Number of connections	12; Notice: 12 connections per CPU, not per interface
<b>Services</b>	
- PG/OP communication	Yes
- Routing	Yes; With master module
- Global data communication	Yes
- S7 basic communication	Yes

3

# SIMATIC ET 200 fail-safe distributed IO

## SIMATIC ET 200S - Interface modules with integrated CPU

### IM 151-7 F-CPU

Order no.	6ES7 151-7FA20-0AB0
- S7 communication	Yes
- S7 communication, as client	No
- S7 communication, as server	Yes
• Transmission rate, max.	12 Mbit/s
DP slave	
• Number of connections	12; Notice: 12 connections per CPU, not per interface
• Services	
- Routing	Yes; Only when interface active and in master mode
- Direct data exchange (slave-to-slave communication)	Yes
- DPV1	No
• GSD file	<a href="http://www.siemens.com/profibus-gsd">http://www.siemens.com/profibus-gsd</a>
• Transmission rate, max.	12 Mbit/s
• Automatic baud rate search	Yes; only with passive interface
• Transfer memory	
- Inputs	244 byte
- Outputs	244 byte
• Address area, max.	32
• User data per address area, max.	32 byte; up to max. size of the transfer memory
<b>2nd interface</b>	
Type of interface	External interface via master module 6ES7138-4HA00-0AB0
Physics	RS 485
Isolated	Yes
Power supply to interface (15 to 30 V DC), max.	No
Functionality	
• MPI	No
• DP master	Yes
• Local Operating Network	No
DP master	
• Number of connections, max.	12; Notice: 12 connections per CPU, not per interface
• Services	
- PG/OP communication	Yes
- Routing	Yes
- Global data communication	No
- S7 basic communication	Yes; I blocks only
- S7 communication	Yes
- S7 communication, as client	No
- S7 communication, as server	Yes
- Equidistance mode support	Yes
- SYNC/FREEZE	Yes
- Activation/deactivation of DP slaves	Yes
- Direct data exchange (slave-to-slave communication)	Yes
- DPV1	Yes
• Transmission rate, max.	12 Mbit/s
• Number of DP slaves, max.	32; per station
• Address area	
- Inputs, max.	2 Kbyte
- Outputs, max.	2 Kbyte
• User data per DP slave	
- Inputs, max.	244 byte
- Outputs, max.	244 byte

Order no.	6ES7 151-7FA20-0AB0
<b>Isochronous mode</b>	
Isochronous mode	No
<b>Programming</b>	
Configuration rules	max. 63 peripheral modules per station; station width < 1 m or < 2 m; max. 10 A per load group (power module); master interface module on right next to IM 151-7 CPU (X2 interface)
Programming language	
• STEP 7	Yes
• LAD	Yes
• FBD	Yes
• STL	Yes
• SCL	Yes; Optional
• GRAPH	Yes; Optional
Command set	See instruction list
Nesting levels	8
Know-how protection	
• User program protection/password protection	Yes
System functions (SFC)	See instruction list
System function blocks (SFB)	See instruction list
<b>Isolation</b>	
Isolation checked with	500 VDC
<b>Galvanic isolation</b>	
between load voltage and all other switching components	Yes
between PROFIBUS DP and all other circuit components	Yes
<b>Permissible potential difference</b>	
between different circuits	75 VDC / 60 VAC
<b>Dimensions and weight</b>	
Dimensions	
• Width	60 mm; DP master module: 35 mm
• Height	119.5 mm
• Depth	75 mm
Weight	
• Weight, approx.	200 g; DP master module: Approx. 100 g



# SIMATIC ET 200 fail-safe distributed IO

## SIMATIC ET 200S - Interface modules with integrated CPU

IM 151-7 F-CPU

### Selection and ordering data

	Order No.
<b>IM151-7 F-CPU interface module</b> For configuring a fail-safe automation system	<b>6ES7 151-7FA20-0AB0</b>
<b>SIPLUS IM 151-7 CPU interface module</b> SIPLUS version is suitable for extended temperature range and demanding medial exposure	<b>6AG1 151-7FA20-2AB0</b>
<b>Accessories</b> <b>Distributed Safety V5.4 programming tool</b> Task: Software for configuring fail-safe user programs for SIMATIC S7-300F, S7-400F, ET 200S Requirement: STEP 7 V5.3 SP3 and higher Floating license Software Update Service	<b>6ES7 833-1FC02-0YA5</b> <b>6ES7 833-1FC00-0YX2</b>
<b>Distributed Safety Upgrade</b> From V5.x to V5.3; Floating license for 1 user	<b>6ES7 833-1FC02-0YE5</b>
<b>MMC 64 kByte</b> for program backup	<b>6ES7 953-8LF20-0AA0</b>
<b>MMC 128 kByte</b> for program backup	<b>6ES7 953-8LG20-0AA0</b>
<b>MMC 512 kByte</b> for program backup	<b>6ES7 953-8LJ20-0AA0</b>
<b>MMC 2 MByte</b> For program backup and/or firmware update	<b>6ES7 953-8LL20-0AA0</b>
<b>MMC 4 MByte</b> for program backup	<b>6ES7 953-8LM20-0AA0</b>
<b>External prommer</b> for MMC with USB interface	<b>6ES7 792-0AA00-0XA0</b>
<b>Termination module</b> as spare part for ET 200S	<b>6ES7 193-4JA00-0AA0</b>
<b>SIMATIC S5, 35 mm DIN rail</b> <ul style="list-style-type: none"> <li>• Length: 483 mm for 19" cabinets</li> <li>• Length: 530 mm for 600 mm cabinets</li> <li>• Length: 830 mm for 900 mm cabinets</li> <li>• 2 m long</li> </ul>	<b>6ES5 710-8MA11</b> <b>6ES5 710-8MA21</b> <b>6ES5 710-8MA31</b> <b>6ES5 710-8MA41</b>

### Additional Information

#### Brochures

You can download information material in the Internet:

<http://www.siemens.com/simatic/printmaterial>

# SIMATIC ET 200 fail-safe distributed IO

## SIMATIC ET 200S - Interface modules with integrated CPU

### IM 151-8 F PN/DP CPU

#### Overview



- Interface module for SIMATIC ET 200S with integrated fail-safe CPU
- For constructing a fail-safe automation system for plants with increased safety requirements
- Complies with safety requirements up to SIL 3 according to IEC 61508, IEC 62061, up to PLe according to ISO 13849-1:2006 and Cat. 4 according to EN 954-1
- For high-performance control solutions in ET 200S
- Increase of the availability of systems and machines
- PROFINET IO-Controller for up to 128 IO-Devices
- PROFINET interface with integrated 3-port switch
- With many communication options: PG/OP communication, PROFINET IO, PROFINET CBA, open IE communication (TCP, ISO-on-TCP and UDP), web server and S7-communication (with loadable FBs)
- Fast, simple and end-to-end programming of a system with modular programs via STEP 7
- Compact SIMATIC Micro Memory Card (MMC)
- Optional PROFIBUS master for 32 PROFIBUS DP slaves (with master interface 6ES7138-4HA00-0AB0)

Note:  
SIMATIC Micro Memory Card required for operation of CPU.

#### SIPLUS Version

A SIPLUS version of this module is also available.

SIPLUS IM 151-8 F PN/DP CPU interface module	
Order No.	6AG1 151-8FB01-2AB0
Order No. based on	6ES7 151-8FB01-0AB0
Permitted ambient temperature	-25 ... +60 °C
Permitted relative humidity	5 ... 100 %, condensation is allowed
Conformal coating	Coating material of circuit boards and of electronic circuitry
Technical data	The technical data are identical with those of the based-on module, except for the ambient conditions.

Technical documentation for SIPLUS is available at:  
<http://www.siemens.com/siplus-extreme>

#### Application

The IM 151-8F PN/DP CPU can be used for remote, distributed automation solutions with average programming complexity. It enables remote preprocessing of the process data on site and

only transmits required data to the higher-level control unit. This results in the following advantages:

- Relieves the central control unit
- Short response times to critical signals on site
- Low data volume relieves bus system
- Pretested units and parallel commissioning enable faster set-up
- Autonomous machine units increase availability and flexibility
- Clear configuration processes

The IM 151-8F PN/DP CPU operates completely independent of the central control unit. If it fails, the IM 151-8F PN/DP CPU simply continues to run.

The bit-modular design of the ET 200S I/O system together with the IM 151-8F PN/DP CPU enable functionally oriented station design.

#### Design

The IM 151-8F PN/DP CPU features the following:

- Microprocessor; execution time 100 ns per binary instruction
- 256 KB main memory
- Bit-modular expandability for maximum flexibility; up to 63 I/O modules (power, electronic, technology and motor starter modules) in any combination
- PROFINET interface with 3 integrated switch ports (RJ45)
- A password concept protects the user program from unauthorized access
- Diagnostics buffer for the last 500 errors and interrupt events (the last 100 entries are retentive)
- SIMATIC MMC; for maintenance-free data backup without battery
  - Program backup (load memory)
  - Firmware update using MMC
  - External load memory on MMC
- Update via MMC or online update via networks
- Hardware clock; date and time can be appended to diagnostic messages of the CPU
- Integrated communication functions:
  - PG/OP communication
  - PROFINET IO
  - Open IE communication (TCP, ISO-on-TCP and UDP)
  - Web server
  - PROFINET CBA
  - S7 communication (with loadable FBs)
- Alarm response time (OB40) less than 10 ms

#### Function

##### Configurable and programmable properties

- I/O setup: Type and scope
- Startup and cycle behavior: Stipulation of maximum cycle time and loading as well as self-test functions
- Definition of the number of retentive bit memories, counters, timers and data blocks
- Clock memory: Address setting
- Protection level: Specifying the access rights to programs and data
- Definition of the handling and scope of diagnostic messages
- Watchdog interrupts: Setting of periodicity
- Time-of-day interrupts: Setting of date and time of start and periodicity

# SIMATIC ET 200 fail-safe distributed IO

## SIMATIC ET 200S - Interface modules with integrated CPU

### IM 151-8 F PN/DP CPU

#### Information and display functions

- Status and error functions; LEDs indicate, for example, hardware, programming, time or I/O errors, as well as operating states such as RUN, STOP, restart, etc.
- Test functions; the PG is used to indicate signal status during program execution, to modify process variables independently of the user program and to output the contents of stack memories
- Information functions; you can use the programming device to obtain information about the storage capacity and operating mode of the CPU as well as the current utilization of the main and load memories, current cycle times and diagnostic buffer contents in plain text

#### Programming, parameterization

The ET 200S with IM 151-8 PN/DP CPU can be universally programmed, configured and diagnosed from any point in the network. STEP 7, V5.4 SP4 or higher, is used for this.

#### SIMATIC S7 Distributed Safety option package

The STEP 7 option package "SIMATIC S7 Distributed Safety" is required to program the safety-related program components. The package includes all required functions and modules to create the F program.

The F program with safety functions is connected in F-FBD or F-LAD or with special function blocks from the F library. Using F-FBD or F-LAD simplifies system configuration and programming and, due to the universal and uniform display, also the acceptance. The programmer can concentrate completely on configuring the safety-related application without the need to use additional tools.

#### Technical specifications

Order No.	6ES7 151-8FB01-0AB0
<b>Product version</b> associated programming package	STEP 7 V 5.5 or higher, Distributed Safety V 5.4 SP4
<b>Supply voltages</b> Rated value	
• permissible range, lower limit (DC)	20.4 V
external protection for supply cables (recommendation)	24 V DC/16 A miniature circuit breaker with type B and C tripping characteristics. Note: A 24 V DC/16 A miniature circuit breaker with type B tripping characteristics trips before and with type C tripping characteristic after the device protection fuse.
Mains buffering	
• Mains/voltage failure stored energy time	5 ms
<b>Current consumption</b>	
Inrush current, max.	1.8 A; typ.
$I^2t$	0.13 A <sup>2</sup> ·s
Current output to backplane bus (DC 5 V), max.	700 mA
from supply voltage 1L+, max.	352 mA; 426 mA with DP master module
<b>Power losses</b>	
Power loss, typ.	5.5 W
<b>Memory</b>	
Work memory	
• integrated	256 Kbyte; for program and data
• expandable	No
• Size of retentive memory for retentive data blocks	64 kbyte

Order No.	6ES7 151-8FB01-0AB0
Load memory	
• pluggable (MMC)	Yes
• pluggable (MMC), max.	8 Mbyte
<b>CPU-blocks</b>	
Number of blocks (total)	1 024; (DBs, FCs, FBs); the maximum number of loadable blocks can be reduced by the MMC used.
DB	
• Number, max.	1 024; Number range: 1 to 16,000
• Size, max.	64 Kbyte
FB	
• Number, max.	1 024; Number range: 0 to 7,999
• Size, max.	64 Kbyte
FC	
• Number, max.	1 024; Number range: 0 to 7,999
• Size, max.	64 Kbyte
OB	
• Size, max.	64 Kbyte
Nesting depth	
• per priority class	16
• additional within an error OB	4
<b>CPU processing times</b>	
for bit operations, min.	0.06 µs
for word operations, min.	0.12 µs
for fixed point arithmetic, min.	0.16 µs
for floating point arithmetic, min.	0.59 µs
<b>Counters, timers and their retentivity</b>	
S7 counter	
• Number	256
• Retentivity	
- can be set	Yes
- lower limit	0
- upper limit	255
- preset	Z 0 to Z 7
• Counting range	
- can be set	Yes
- lower limit	0
- upper limit	999
IEC counter	
• Type	SFB
• Number	Unlimited (limited only by RAM capacity)
S7 times	
• Number	256
• Retentivity	
- can be set	Yes
- lower limit	0
- upper limit	255
- preset	No retentivity
• Time range	
- lower limit	10 ms
- upper limit	9 990 s
IEC timer	
• Type	SFB
• Number	Unlimited (limited only by RAM capacity)

# SIMATIC ET 200 fail-safe distributed IO

## SIMATIC ET 200S - Interface modules with integrated CPU

### IM 151-8 F PN/DP CPU

Order No.	6ES7 151-8FB01-0AB0
<b>Data areas and their retentivity</b>	
Flag	
• Number, max.	256 byte
• Retentivity available	Yes
• Retentivity preset	MB 0 to MB 15
• Number of clock memories	8; 1 memory byte
<b>Data blocks</b>	
• Number, max.	1 024; Number range: 1 to 16,000
• Size, max.	64 Kbyte
• Retentivity adjustable	Yes; via non-retain property on DB
• Retentivity preset	Yes
<b>Local data</b>	
• per priority class, max.	32 768 byte; 2048 bytes max. per block
<b>Address area</b>	
I/O address area	
• overall	2 048 byte
• Outputs	2 048 byte
• of which, distributed	
- Inputs	2 048 byte
- Outputs	2 048 byte
<b>Process image</b>	
• Inputs, adjustable	2 048 byte
• Outputs, adjustable	2 048 byte
• Inputs, default	128 byte
• Outputs, default	128 byte
<b>Subprocess images</b>	
• Number of subprocess images, max.	1; With PROFINET IO, the length of the user data is limited to 1600 bytes
<b>Digital channels</b>	
• Inputs	16 336
• Outputs	16 336
• Inputs, of which central	496
• Outputs, of which central	496
<b>Analog channels</b>	
• Inputs	1 021
• Outputs	1 021
• Inputs, of which central	124
• Outputs, of which central	124
<b>Hardware configuration</b>	
Number of mounting rails that can be used	1
Max. length of mounting rail	Station width: ≤ 1 m or < 2 m
Number of modules per system, max.	63; Centralized
<b>Time of day</b>	
Clock	
• Hardware clock (real-time clock)	Yes
• battery-backed and synchronizable	Yes
• Backup time	6 wk; At 40 °C ambient temperature, typically
• Behavior of the clock following POWER-ON	Clock continues running after POWER OFF
• Behavior of the clock following expiry of backup period	Clock continues to run with the time at which the power failure occurred
• Deviation per day, max.	10 s; typ.: 2 s

Order No.	6ES7 151-8FB01-0AB0
<b>Runtime meter</b>	
• Number	1
• Number/Number range	0
• Range of values	0 to 2 <sup>31</sup> hours (when using SFC 101)
• Granularity	1 hour
• retentive	Yes; must be restarted at each restart
<b>Clock synchronization</b>	
• supported	Yes
• to MPI, master	No
• to MPI, slave	No
• to DP, master	Yes; with DP master module
• to DP, slave	Yes; with DP master module
• in AS, master	No
• in AS, slave	No
• on Ethernet via NTP	Yes; as client
<b>S7 message functions</b>	
Number of login stations for message functions, max.	12; Depending on the configured connections for PG/OP and S7 basic communication
<b>Process diagnostic messages</b>	
	Yes; ALARM_S, ALARM_SC, ALARM_SQ, ALARM_D, ALARM_DQ
simultaneously active alarm-S blocks, max.	300
<b>Test commissioning functions</b>	
Status/control	
• Status/control variable	Yes
• Variables	Inputs, outputs, memory bits, DB, times, counters
• Number of variables, max.	30
• of which status variables, max.	30
• of which control variables, max.	14
<b>Forcing</b>	
• Forcing	Yes
Status block	Yes; up to 2 simultaneously
Single step	Yes
Number of breakpoints	4
<b>Diagnostic buffer</b>	
• present	Yes
• Number of entries, max.	500
- can be set	No
- Of which powerfail-proof	100; Only the last 100 entries are retained
<b>Monitoring functions</b>	
Status LEDs	Yes
<b>Communication functions</b>	
PG/OP communication	Yes
Data record routing	Yes; with DP master module
Routing	Yes; with DP master module
<b>Global data communication</b>	
• supported	No
<b>S7 basic communication</b>	
• supported	Yes; I blocks
• User data per job, max.	76 byte
• User data per job (of which consistent), max.	76 byte

# SIMATIC ET 200 fail-safe distributed IO

## SIMATIC ET 200S - Interface modules with integrated CPU

### IM 151-8 F PN/DP CPU

Order No.	6ES7 151-8FB01-0AB0
S7 communication	
• supported	Yes
• as server	Yes
• as client	Yes; via integrated PN interface and loadable FBs
• User data per job, max.	See online help of STEP 7 (shared parameters of the SFBs/FBs and of the SFCs/FCs of S7 Communication)
Web server	
• supported	Yes
• Number of HTTP clients	5
• User-defined websites	Yes
Open IE communication	
• TCP/IP	Yes; via integrated PROFINET interface and loadable FBs
- Number of connections, max.	8
- Data length for connection type 01H, max.	1 460 byte
- Data length for connection type 11H, max.	32 768 byte
- Several passive connections per port, supported	Yes
• ISO-on-TCP (RFC1006)	Yes; via integrated PROFINET interface and loadable FBs
- Number of connections, max.	8
- Data length, max.	32 768 byte
• UDP	Yes; via integrated PROFINET interface and loadable FBs
- Number of connections, max.	8
- Data length, max.	1 472 byte
Number of connections	
• overall	12
• usable for PG communication	11
- reserved for PG communication	1
- Adjustable for PG communication, min.	1
• usable for OP communication	11
- reserved for OP communication	1
- adjustable for OP communication, min.	1
• usable for S7 basic communication	10
- Reserved for S7 basic communication	0
- adjustable for S7 basic communication, min.	0
• usable for S7 communication	10; with loadable FBs
- Adjustable for S7 communication, max.	10
• Max. total number of instances	32
• usable for routing	4; max.
PROFINET CBA (at set setpoint communication load)	
• Setpoint for the CPU communication load	50 %
• Number of remote interconnection partners	32
• Number of functions, master/slave	30
• Total of all Master/Slave connections	1 000
• Data length of all incoming connections master/slave, max.	4 000 byte
• Data length of all outgoing connections master/slave, max.	4 000 byte
• Number of device-internal and PROFIBUS interconnections	500
• Data length of device-internal und PROFIBUS interconnections, max.	4 000 byte

Order No.	6ES7 151-8FB01-0AB0
• Data length per connection, max.	1 400 byte
• Remote interconnections with acyclic transmission	
- Sampling frequency: Sampling time, min.	500 ms
- Number of incoming interconnections	100
- Number of outgoing interconnections	100
- Data length of all incoming interconnections, max.	2 000 byte
- Data length of all outgoing interconnections, max.	2 000 byte
- Data length per connection, max.	1 400 byte
• Remote interconnections with cyclic transmission	
- Transmission frequency: Transmission interval, min.	1 ms
- Number of incoming interconnections	200
- Number of outgoing interconnections	200
- Data length of all incoming interconnections, max.	2 000 byte
- Data length of all outgoing interconnections, max.	2 000 byte
- Data length per connection, max.	450 byte
• HMI variables via PROFINET (acyclic)	
- Number of stations that can log on for HMI variables (PN OPC/iMap)	3; 2x PN OPC/1x iMap
- HMI variable updating	500 ms
- Number of HMI variables	200
- Data length of all HMI variables, max.	2 000 byte
• PROFIBUS proxy functionality	
- supported	Yes
- Number of linked PROFIBUS devices	16
- Data length per connection, max.	240 byte; slave-dependent
<b>1st interface</b>	
Type of interface	PROFINET
Physics	Ethernet
Isolated	Yes
Integrated switch	Yes
Number of ports	3; RJ45
automatic detection of transmission speed	Yes
Autonegotiation	Yes
Autocrossing	Yes
Media redundancy	
• supported	Yes
• Switchover time on line break, typically	200 ms; PROFINET MRP
• Number of stations in the ring, max.	50
Change of IP address at runtime, supported	Yes
Functionality	
• MPI	No
• DP master	No
• DP slave	No
• PROFINET IO Device	Yes; Also simultaneously with IO Controller functionality

# SIMATIC ET 200 fail-safe distributed IO

## SIMATIC ET 200S - Interface modules with integrated CPU

### IM 151-8 F PN/DP CPU

Order No.	6ES7 151-8FB01-0AB0
• PROFINET IO Controller	Yes; also simultaneously with IO Device functionality
• PROFINET CBA	Yes
• Open IE communication	Yes
• Web server	Yes
- Number of HTTP clients	5
• Point-to-point connection	No
PROFINET IO Controller	
• Services	
- PG/OP communication	Yes
- Routing	Yes; with DP master module
- S7 communication	Yes; with loadable FBs
- Isochronous mode	Yes; OB 61; only for PROFINET IO
- Open IE communication	Yes; Via TCP/IP, ISO on TCP, and UDP
• Transmission rate, max.	100 Mbit/s; full duplex
• Number of connectable IO devices, max.	128
• Max. number of connectable IO devices for RT	128
- of which in line, max.	128
• Number of IO devices with IRT and the option "high flexibility"	128
- of which in line, max.	61
• Number of IO Devices with IRT and the option "high performance", max.	64
- of which in line, max.	64
• IRT, supported	Yes
- Shared device, supported	Yes
• Prioritized startup supported	Yes
- Number of IO Devices, max.	32
• Activation/deactivation of IO Devices	Yes
- Number of IO Devices that can be simultaneously activated/deactivated, max.	8
• IO Devices changing during operation (partner ports), supported	Yes
- Max. number of IO devices per tool	8
• Device replacement without swap medium	Yes
• Send cycles	250 µs, 500 µs, 1 ms; 2 ms, 4 ms (not in the case of IRT with "high flexibility" option)
• Updating time	Minimum value depends on communication share set for PROFINET I/O, on the number of I/O devices, and on the number of configured user data items.
• Updating times	250 µs to 512 ms (depends on operating mode; for more details, refer to Operating Instructions, "Interface Module IM151-8 PN/DP CPU")
• Address area	
- Inputs, max.	2 kbyte
- Outputs, max.	2 kbyte
• User data per address area, max.	
- User data consistency, max.	1 024 byte; with PROFINET I/O
PROFINET IO device	
• Services	
- PG/OP communication	Yes
- Routing	Yes
- S7 communication	Yes; With loadable FBs
- Isochronous mode	No
- Open IE communication	Yes; Via TCP/IP, ISO on TCP, UDP
- IRT, supported	Yes

Order No.	6ES7 151-8FB01-0AB0
- PROFlenergy, supported	Yes; With SFB 73 / 74 prepared for loadable PROFlenergy standard FB for I-Device
- Shared device, supported	Yes
- Number of IO controllers with shared device, max.	2
• Transfer memory	
- Inputs, max.	1 440 byte; per IO Controller with shared device
- Outputs, max.	1 440 byte; per IO Controller with shared device
• Submodules	
- Number, max.	64
- User data per submodule, max.	1 024 byte
PROFINET CBA	
• acyclic transmission	Yes
• cyclic transmission	Yes
Open IE communication	
• Open IE communication, supported	Yes; Via TCP/IP, ISO on TCP, and UDP
• Number of connections, max.	8
• Local port numbers used at the system end	0, 20, 21, 23, 25, 80, 102, 135, 161, 8080, 34962, 34963, 34964, 65532, 65533, 65534, 65535
<b>2nd interface</b>	
Type of interface	External interface via master module 6ES7138-4HA00-0AB0
Physics	RS 485
Isolated	Yes
Power supply to interface (15 to 30 V DC), max.	No
Functionality	
• MPI	No
• DP master	Yes
• DP slave	No
• PROFINET IO Controller	No
• PROFINET IO Device	No
• PROFINET CBA	No
• Open IE communication	No
• Web server	No
DP master	
• Services	
- PG/OP communication	Yes
- Routing	Yes
- Global data communication	No
- S7 basic communication	Yes; I blocks only
- S7 communication	Yes
- S7 communication, as client	No
- S7 communication, as server	Yes
- Equidistance mode support	Yes
- Isochronous mode	No
- SYNC/FREEZE	Yes
- Activation/deactivation of DP slaves	Yes
- Number of DP slaves that can be simultaneously activated/deactivated, max.	8
- Direct data exchange (slave-to-slave communication)	Yes
- DPV1	Yes
• Transmission rate, max.	12 Mbit/s
• Number of DP slaves, max.	32; per station
• Address area	
- Inputs, max.	2 048 byte
- Outputs, max.	2 048 byte
• User data per DP slave	
- Inputs, max.	244 byte
- Outputs, max.	244 byte

# SIMATIC ET 200 fail-safe distributed IO

## SIMATIC ET 200S - Interface modules with integrated CPU

IM 151-8 F PN/DP CPU

Order No.	6ES7 151-8FB01-0AB0
<b>Isochronous mode</b>	
Isochronous mode	No
<b>Programming</b>	
Programming language	
• STEP 7	Yes; V5.5 or higher
• LAD	Yes
• FBD	Yes
• STL	Yes
• SCL	Yes; Optional
• CFC	Yes; optional
• GRAPH	Yes; Optional
• HiGraph®	Yes; optional
Command set	See instruction list
Nesting levels	8
Know-how protection	
• User program protection/password protection	Yes
• Block encryption	Yes; With S7 block Privacy
System functions (SFC)	See instruction list
System function blocks (SFB)	See instruction list
<b>Interrupts/diagnostics/status information</b>	
Alarms	
• Alarms	Yes
Diagnoses	
• Diagnostic functions	Yes
Diagnostics indication LED	
• Bus activity PROFINET P1-LINK (green)	Yes
• Bus activity PROFINET P2-LINK (green)	Yes
• Bus activity PROFINET P3-LINK (green)	Yes
• Bus error (red)	Yes
• Maintenance information <sup>1</sup>	Yes
• MT (yellow)	Yes
• Group error SF (red)	Yes
• Monitoring 24 V voltage supply ON (green)	Yes
<b>Isolation</b>	
Isolation checked with	500 VDC
<b>Galvanic isolation</b>	
between PROFIBUS DP and all other circuit components	Yes
<b>Permissible potential difference</b>	
between different circuits	75 VDC / 60 VAC
<b>Dimensions and weight</b>	
Dimensions	
• Width	120 mm; DP master module: 35 mm
• Height	119.5 mm
• Depth	75 mm
Weight	
• Weight, approx.	320 g; DP master module: Approx. 100 g

# SIMATIC ET 200 fail-safe distributed IO

## SIMATIC ET 200S - Interface modules with integrated CPU

### IM 151-8 F PN/DP CPU

#### Selection and ordering data

	Order No.
<b>IM 151-8F PN/DP CPU interface module (256 K)</b> Including termination module	<b>6ES7 151-8FB01-0AB0</b>
<b>SIPLUS 151-8F PN/DP CPU interface module</b> SIPLUS version is suitable for extended temperature range and demanding medial exposure	<b>6AG1 151-8FB00-2AB0</b>
<b>Distributed Safety V5.4 programming tool</b> Task: Software for configuring fail-safe application programs for SIMATIC S7-300F, S7-400F, ET 200S Requirement: STEP 7 V5.3 SP3 and higher Floating license Software Update Service	<b>6ES7 833-1FC02-0YA5</b> <b>6ES7 833-1FC00-0YX2</b>
<b>Distributed Safety Upgrade</b> From V5.3 to V5.4; Floating license for 1 user	<b>6ES7 833-1FC02-0YE5</b>
<b>Accessories</b>	
<b>MMC 64 KB <sup>1)</sup></b> for program backup	<b>6ES7 953-8LF20-0AA0</b>
<b>MMC 128 KB <sup>1)</sup></b> for program backup	<b>6ES7 953-8LG20-0AA0</b>
<b>MMC 512 KB <sup>1)</sup></b> for program backup	<b>6ES7 953-8LJ20-0AA0</b>
<b>MMC 2 MB <sup>1)</sup></b> for program backup and/or firmware update	<b>6ES7 953-8LL20-0AA0</b>
<b>MMC 4 MB <sup>1)</sup></b> for program backup	<b>6ES7 953-8LM20-0AA0</b>
<b>MMC 8 MB <sup>1)</sup></b> for program backup	<b>6ES7 953-8LP20-0AA0</b>
<b>External prommer</b> e.g. for MMC with USB interface	<b>6ES7 792-0AA00-0XA0</b>
<b>PG</b> with integrated MMC interface	<b>on request</b>
<b>Label sheets DIN A4 (10 units)</b> Each sheet contains 60 labeling strips for peripheral modules and 20 labeling strips for interface modules • petrol • red • yellow • light beige	<b>6ES7 193-4BH00-0AA0</b> <b>6ES7 193-4BD00-0AA0</b> <b>6ES7 193-4BB00-0AA0</b> <b>6ES7 193-4BA00-0AA0</b>
<b>ET 200S distributed I/O system manuals</b> are available on the Internet as PDF files: <a href="http://www.siemens.com/simatic-docu">http://www.siemens.com/simatic-docu</a>	
<b>Termination module</b> as spare part for ET 200S	<b>6ES7 193-4JA00-0AA0</b>

	Order No.
<b>SIMATIC S5, 35 mm DIN rail</b> • Length: 483 mm for 19" cabinets • Length: 530 mm for 600 mm cabinets • Length: 830 mm for 900 mm cabinets • 2 m long	<b>6ES5 710-8MA11</b> <b>6ES5 710-8MA21</b> <b>6ES5 710-8MA31</b> <b>6ES5 710-8MA41</b>
<b>Industrial Ethernet FC RJ45 Plug 180</b> RJ45 plug connector for Industrial Ethernet with a rugged metal enclosure and integrated insulation displacement contacts for connecting Industrial Ethernet FC installation cables; with 180° cable outlet • 1 unit • 10 units • 50 units	<b>6GK1 901-1BB10-2AA0</b> <b>6GK1 901-1BB10-2AB0</b> <b>6GK1 901-1BB10-2AE0</b>
<b>Industrial Ethernet FastConnect installation cables</b> • Fast Connect standard cable • Fast Connect trailing cable • Fast Connect marine cable	<b>6XV1 840-2AH10</b> <b>6XV1 840-3AH10</b> <b>6XV1 840-4AH10</b>
<b>Industrial Ethernet FastConnect stripping tool</b>	<b>6GK1 901-1GA00</b>

1) An MMC is essential for operating the CPU



# SIMATIC ET 200 fail-safe distributed IO

## SIMATIC ET 200S - Interface modules with integrated CPU

### Master interface module for IM 151-7F CPU and IM 151-8F PN/DP CPU

#### Overview



PROFIBUS DP master interface module for IM 151-7(F) CPU/ IM 151-8(F) PN/DP CPU interface modules

- Integrated 12 Mbit/s PROFIBUS DP master interface in copper design
- Facilitates parallel operation of two PROFIBUS DP interfaces on one IM 151-7 CPU
- Enables operation of a PROFIBUS DP interface on an IM 151-8(F) PN/DP CPU
- Increases the availability of plants and machinery
- Functionality corresponds to the interface of an S7-300 CPU 314-2 DP configured as DP master

Programming is with STEP7 from Version V5.2 with Service Pack 1.

#### SIPLUS Version

A SIPLUS version of this module is also available.

SIPLUS CPU 315F-2 DP	
<b>Order No.</b>	<b>6AG1 138-4HA00-7AB0</b>
<b>Order No. based on</b>	<b>6ES7 138-4HA00-0AB0</b>
Permitted ambient temperature	-25 ... +70 °C
Permitted relative humidity	5 ... 100 %, condensation is allowed
Conformal coating	Coating material of circuit boards and of electronic circuitry in accordance with EN 60721
Technical data	The technical data are identical with those of the based-on module, except for the ambient conditions.
Biologically, chemically and mechanically active substances	Conformity with EN 60721-3-3
Air pressure (depending on the highest positive temperature range specified)	1080 ... 795 hPa (-1000 ... +2000 m) see ambient temperature range 795 ... 658 hPa (+2000 ... +3500 m), derating 10 K 658 ... 540 hPa (+3500 ... +5000 m), derating 20 K

Technical documentation for SIPLUS is available at:

<http://www.siemens.com/siplus-extreme>

- Offloading of the central controller by means of distributed preprocessing
- IM 151-7(F) CPU/IM 151-8(F) PN/DP CPU possible as PROFIBUS DP master in stand-alone mode
- Use of the CPU in hierarchical networks, e.g. with IE/PB Link also on Ethernet (CBA, etc.)

#### Design

The master interface module has a 9-pin Sub-D connector (socket) for connecting to PROFIBUS DP. The master interface module is to be plugged in to the right of the IM 151-7(F) CPU/IM 151-8(F) PN/DP CPU.

#### Function

The master interface module adds a DP master interface to the IM 151-7(F) CPU/IM 151-8(F) PN/DP CPU. The functionality and quantity structures are defined by the IM 151-7(F) CPU/IM 151-8(F) PN/DP CPU.

The master interface module also enables connection of a programming device to its interface. This makes routing to bus nodes possible on the integral CPU interface possible if it is operated in active mode.

#### Technical specifications

6ES7 138-4HA00-0AB0	
<b>Hardware configuration</b>	
Number of modules per CPU	1
<b>Dimensions and weight</b>	
• Width/Height/Depth	35 mm/119.5 mm/75 mm
• Weight, approx.	100 g

#### Selection and ordering data

Order No.	
<b>Master interface module</b>	<b>6ES7 138-4HA00-0AB0</b>
for interface modules IM 151-7 CPU IM 151-7 F-CPU IM 151-8 PN/DP CPU IM 151-8 F PN/DP CPU	
<b>SIPLUS master interface module for IM 151 CPU</b>	<b>6AG1 138-4HA00-7AB0</b>
Suitable for extended temperature range and medial exposure	
<b>Accessories</b>	
<b>Label sheets DIN A4 (10 pieces)</b>	
Each sheet contains 60 label strips for peripheral modules and 20 label strips for interface modules	
• petrol • red • yellow • light beige	<b>6ES7 193-4BH00-0AA0</b> <b>6ES7 193-4BD00-0AA0</b> <b>6ES7 193-4BB00-0AA0</b> <b>6ES7 193-4BA00-0AA0</b>
<b>ET 200S distributed I/O system manuals</b>	
are available in the Internet as PDF files	See <a href="http://www.siemens.com/simatic-docu">http://www.siemens.com/simatic-docu</a>

#### Application

The master interface module adds a DP master interface to the IM 151-7(F) CPU/IM 151-8(F) PN/DP CPU. A lower-level PROFIBUS DP line can thus be established. This results in the following advantages:

#### Additional Information

You can download a brochure in the Internet:

<http://www.siemens.com/simatic/printmaterial>

# SIMATIC ET 200 fail-safe distributed IO

## SIMATIC ET 200S fail-safe modules

### SIMATIC ET 200S fail-safe distributed IO PM-E F PROFIsafe F-power module

#### Overview ET 200S fail-safe distributed IO

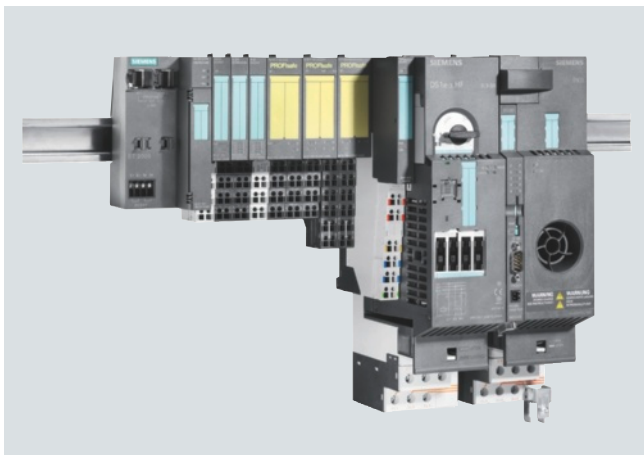

The fail-safe SIMATIC S7 CPUs, plus the fail-safe signal modules of SIMATIC ET 200S / ET200 / 200pro/ ET200eco and ET200M have been specially developed for distributed applications in manufacturing systems. Thanks to the discrete structure of the F I/Os, safety technology is only applied where actually required. The new system replaces conventional electromechanical components, such as:

- Freely programmable safe linking of sensors to actuators;
- Selective safe shutdown of actuators;
- Hybrid configurations of F modules (F stands for fail-safe) and standard modules in a station;
- Single-bus concept, F signals and standard signals are transferred over one bus medium (PROFIBUS DP, PROFINET).

#### Totally Integrated Automation (TIA)

Safety technology (Safety Integrated) is a component of Totally Integrated Automation resulting in the total integration of safety and standard automation (SIMATIC S7).

Whereas today, standard automation (conventional PLCs) and safety automation (electromechanics) are still separate, these two worlds are growing closer together to form one uniform, integrated overall system.

Siemens can therefore present itself as a complete supplier for automation engineering for which safety technology is part of the standard automation and uniformity exists throughout the complete system.

#### Additional Information

##### Brochures

You can download information material in the Internet:

<http://www.siemens.com/simatic/printmaterial>

#### Overview PM-E PROFIsafe F-power module



Fail-safe PM-E F PROFIsafe power modules for safety shutdown of standard digital output modules.

- Up to 2 fail-safe digital outputs onboard (source/sink outputs, up to 2A, up to SIL3/Cat. 4)
- The standard digital output modules can be shut down up to Cat.3 (EN 954) and SIL 2 (IEC61508) up to 10 A. The following modules can be used down-circuit of the power modules.
  - 2DO / 0.5 A ST 6ES7 132-4BB01-0AA0
  - 2 DO / 2 A ST 6ES7 132-4BB31-0AA0
  - 2 DO / 0.5 A HF 6ES7 132-4BB01-0AB0
  - 2 DO / 2 A HF 6ES7 132-4BB31-0AB0
  - 4 DO / 0.5 A ST 6ES7 132-4BD01-0AA0
  - 4 DO / 2 A ST 6ES7 132-4BD31-0AA0

The modules support PROFIsafe, both in PROFIBUS, and in PROFINET configurations. They can be used with all fail-safe SIMATIC S7-CPU.

#### Application

Fail-safe PM-E F PROFIsafe power modules for safety shutdown of standard digital output modules.

The standard digital output modules are supplied over PM-E PROFIsafe and can be shut down with fail-safety using relay contacts according to Cat. 3/ SIL2.

The PM-E F pm PROFIsafe power module can be used for loads configured without a ground connection and has 2 additional fail-safe digital outputs onboard. These are source/sink outputs and can be used for safety circuits up to Cat. 4/ SIL 3.

The PM-E F pp PROFIsafe power modules can be used for loads that are connected to ground, e.g. for actuators that have to be connected to a central mass.

The modules can be operated both down-circuit of the IM151-7 F-CPU in a central configuration and down-circuit of the IM 151 High Feature and IM151-3 PROFINET High Feature in a distributed configuration.

#### Design

PM-E F PROFIsafe power modules are plugged into the TM-P terminal modules provided.

The first module after the IM 151 must be a power module.

### Technical specifications

Order No.	6ES7 138-4CF03-0AB0	6ES7 138-4CF42-0AB0
<b>Power supply</b>		
Current carrying capacity		
• Current carrying capacity up to 30 °C, max.		10 A
• Current carrying capacity up to 40 °C, max.	10 A	8 A
• Current carrying capacity up to 60 °C, max.	6 A	7 A
<b>Supply voltages</b>		
Load voltage L+		
• Rated value (DC)	24 V	24 V
• Reverse polarity protection	No	No
<b>Current consumption</b>		
from load voltage L+ (without load), max.	Typ. 100 mA	Typ. 100 mA
from backplane bus 24 V DC, max.	28 mA	28 mA
<b>Power losses</b>		
Power loss, typ.	4 W	4 W
<b>Address area</b>		
Address space per module		
• without packing	5 byte; Input and output in each case	5 byte; Input and output in each case
<b>Digital inputs</b>		
Cable length		
• Cable length, shielded, max.	200 m	200 m
• Cable length unshielded, max.	200 m	200 m
<b>Digital outputs</b>		
Number of digital outputs	2	1; Relays
Short-circuit protection	Yes; Electronic	No
• Response threshold, typ.	Response threshold (short-circuit): 5 to 12 A; response threshold (external short-circuit to ground): 5 to 12 A; response threshold (external short-circuit to P potential): 25 to 45 A	
Limitation of inductive shutdown voltage to	L+ (-2x 47 V)	
Lamp load, max.	10 W	100 W
Controlling a digital input	No	Yes
<b>Output voltage</b>		
• for signal "1", min.	L+ (-2,0 V), current-sourcing switch: L+ (-1.5 V), voltage drop at current-sinking switch: Max. 0.5 V	
<b>Output current</b>		
• for signal "1" rated value	2 A	
• for signal "1" permissible range for 0 to 60 °C, min.	20 mA	
• for signal "1" permissible range for 0 to 60 °C, max.	2.4 A	
• for signal "0" residual current, max.	0.5 mA	
<b>Parallel switching of 2 outputs</b>		
• for increased power	No	
• for redundant control of a load	No	
<b>Switching frequency</b>		
• with resistive load, max.	30 Hz	2 Hz
• with inductive load, max.	0.1 Hz	0.1 Hz; With inductive load according to IEC 947-5-1, 13 DC/15 AC
• on lamp load, max.	10 Hz	2 Hz
<b>Aggregate current of outputs (per group)</b>		
• horizontal installation		
- up to 40 °C, max.	10 A	10 A
- up to 55 °C, max.	7 A	8 A
- up to 60 °C, max.	6 A	7 A
• vertical installation		
- up to 40 °C, max.	6 A	8 A
<b>Load resistance range</b>		
• lower limit	12 Ω	
• upper limit	1 kΩ	
<b>Cable length</b>		
• Cable length, shielded, max.	200 m	

# SIMATIC ET 200 fail-safe distributed IO

## SIMATIC ET 200S fail-safe modules

### PM-E F PROFIsafe F-power module

Order No.	6ES7 138-4CF03-0AB0	6ES7 138-4CF42-0AB0
- Cable length unshielded, max.	200 m	
<b>Relay outputs</b>		
Switching capacity of contacts		
• at ohmic load, up to 50 °C, max.	10 A	10 A
<b>Interrupts/diagnostics/status information</b>		
Diagnoses		
• Diagnostic functions	Yes	Yes
• Diagnostic information readable	Yes	Yes
• Diagnostics	Yes	
• Wire break	Yes	No
• Short circuit	Yes	Yes
• Missing load voltage	Yes	Yes
Diagnostics indication LED		
• Rated load voltage PWR (green)	Yes	Yes
• Group error SF (red)	Yes	Yes
• Status indicator digital output (green)	Yes	Yes
<b>Isolation</b>		
Isolation checked with	500 V DC	500 V DC
tested with		
• Channels against backplane bus and load voltage L+	500 V DC	500 V DC
<b>Galvanic isolation</b>		
Galvanic isolation digital outputs		
• between the channels	No	No
• between the channels and the backplane bus	Yes	Yes
• between the channels and the load voltage L+	No	No
<b>Standards, approvals, certificates</b>		
Highest safety class achievable in safety mode		
• acc. to EN 954	Up to Cat. 4	With Std-DO: max. Cat.3, without Std-DO max. Cat.4 depending on configuration
• acc. to IEC 61508	Up to SIL 3	With Std-DO: max. SIL 2, without Std-DO max. SIL 3 depending on configuration
<b>Dimensions and weight</b>		
Dimensions		
• Width	30 mm	30 mm
• Height	81 mm	81 mm
• Depth	52 mm	52 mm
Weight		
• Weight, approx.	88 g	80 g

# SIMATIC ET 200 fail-safe distributed IO

## SIMATIC ET 200S fail-safe modules

### PM-E F PROFIsafe F-power module

#### Selection and ordering data

	Order No.
<b>Power module PM-E F pm PROFIsafe, 24 V DC</b> for safe shutdown of digital output modules	<b>6ES7 138-4CF03-0AB0</b>
<b>Power module PM-E F pp PROFIsafe, 24 V DC</b> for safe shutdown of digital output modules	<b>6ES7 138-4CF42-0AB0</b>
<b>Accessories</b>	
<b>IM 151-1 High Feature Interface module</b> for ET 200S; transfer rate up to 12 Mbit/s; data volumes 244 byte each for I/O, up to 63 modules can be connected; connection of PROFIsafe modules, isochronous mode; bus connection via 9-pin Sub-D incl. terminating module	<b>6ES7151-1BA02-0AB0</b>
<b>IM 151-3 PN HF interface module</b> for ET 200S; transfer rate up to 100 Mbit/s; max. 63 I/O modules up to 2 m wide can be connected; 2 x bus connection via RJ45 connector, incl. terminating module	<b>6ES7 151-3BA23-0AB0</b>
<b>IM 151-3 PN FO interface module</b> for ET 200S; 2 PROFINET FO interfaces, integrated 2-port switch, max. 63 I/O modules up to 2 m wide can be connected, incl. terminating module	<b>6ES7 151-3BB23-0AB0</b>
<b>Terminal modules for power modules</b>	
<b>TM-P30S44-A0</b> Ordering unit 1 item 7 x 2 terminals, terminal access to AUX1 bus, AUX1 interrupted to the left, screw-type terminals for PM-E F PROFIsafe	<b>6ES7 193-4CK20-0AA0</b>
<b>TM-P30C44-A0</b> Ordering unit 1 item 7 x 2 terminals, terminal access to AUX1 bus, AUX1 interrupted to the left, spring-loaded terminals for PM-E F PROFIsafe	<b>6ES7 193-4CK30-0AA0</b>
<b>Distributed Safety V5.4 programming tool</b>	
Task: Software for configuring fail-safe user programs for SIMATIC S7-300F, S7-400F, ET 200S Requirement: STEP 7 V5.3 SP3 and higher  Floating license	<b>6ES7 833-1FC02-0YA5</b>
Software Update Service	<b>6ES7 833-1FC00-0YX2</b>
<b>Distributed Safety Upgrade</b> from V5.x to V5.3; Floating license for 1 user	<b>6ES7 833-1FC02-0YE5</b>

	Order No.
<b>SIMATIC Manual Collection</b> Electronic manuals on DVD, five languages: S7-200/300/400, C7, LOGO!, SIMATIC DP, PC, PG, STEP 7, engineering software, runtime software, PCS 7, SIMATIC HMI, SIMATIC NET	<b>6ES7 998-8XC01-8YE0</b>
<b>SIMATIC Manual Collection update service for 1 year</b>	<b>6ES7 998-8XC01-8YE2</b>

#### Additional Information

##### Brochures

You can download information material in the Internet:

<http://www.siemens.com/simatic/printmaterial>

# SIMATIC ET 200 fail-safe distributed IO

## SIMATIC ET 200S fail-safe modules

### F electronic modules

#### Overview



Digital inputs/outputs for the fail-safe SIMATIC S7 systems

Fail-safe digital input module

- For fail-safe reading of sensor information (1 or 2 channels)
- Provides integral discrepancy evaluation for 2-out-of-2 signals
- 2 internal sensor supplies (incl. test function) onboard
- Certified up to Cat. 4 (EN954-1), SIL 3 (IEC 61508), PL e (ISO 13849)

Fail-safe digital output module

- Fail-safe 2-channel activation (sink/source output) by actuators
- Actuators can be driven by up to 2 A
- Certified up to Cat. 4 (EN954-1), SIL 3 (IEC 61508), PL e (ISO 13849)

Fail-safe digital hybrid module

- 4 fail-safe inputs/3 fail-safe outputs
- Certified up to Cat. 3 (EN954-1), SIL 2 (IEC 61508), PL d (ISO 13849)

The modules support PROFIsafe, both in PROFIBUS, and in PROFINET configurations. They can be used with all fail-safe SIMATIC S7 CPUs.

#### SIPLUS versions

SIPLUS versions are also available:

	SIPLUS electronic module 4/8 F-DI, PROFIsafe 24 V DC	SIPLUS electronic module 4 F-DO, PROFIsafe 24 V DC/2 A
Order number	6AG1 138-4FA04-2AB0	6AG1 138-4FB03-2AB0
Order No. based on	6ES7 138-4FA04-0AB0	6ES7 138-4FB03-0AB0
Ambient temperature range	-25 ... +60 °C	
Conformal coating	Coating of the printed circuit boards and the electronic components	
Technical data	The technical data of the standard product applies except for the environmental conditions.	
Relative humidity	5 ... 100%, condensation allowed	

The technical documentation on SIPLUS can be found here:

<http://www.siemens.com/siplus-extreme>

#### Application

The fail-safe modules of ET 200S can be used to implement the safety-related application requirements as an integral part of the overall automation. The safety functions required for fail-safe operation are integrated in the modules. The modules can be used for safety circuits up to Cat. 4/ SIL 3.

Communication to fail-safe SIMATIC S7 CPUs is performed by means of PROFIsafe.

The modules can be operated both down-circuit of the IM151-7 F-CPU in a central configuration and down-circuit of the IM 151 High Feature and IM151-3 PROFINET High Feature in a distributed configuration.

A standard power module is required to supply the modules.

#### Design

Digital input/output modules have the following features:

##### Compact design

The rugged plastic casing contains

- Green LEDs to display the signal states at the inputs/outputs
- Plug option for the front connector, protected behind the front door
- Labeling strip on the front door (yellow for fail-safe modules).

##### Simple connection

The modules are mounted on the standard rail and connected to neighboring modules via the bus connector. There are no slot rules and the addresses of the inputs are assigned via the slot.

By using them in the distributed I/O station ET 200M in combination with active bus modules, the modules can be replaced during operation with the equipment live. The remaining modules continue to operate.

##### User-friendly wiring

The modules are wired up via a front connector. When it is plugged in for the first time, a coding device latches in the connector so that the connector will only fit onto modules of this type. When the module is replaced, the fully wired front connector can be plugged into the new module of the same type.

In the case of fail-safe input modules, the necessary encoder power supply (test outputs) are provided. These test outputs can be activated via parameterization.

### Technical specifications

Order No.	6ES7 138-4FA04-0AB0
<b>Supply voltages</b>	
Rated value	
• 24 V DC	Yes
• permissible range, lower limit (DC)	20.4 V
• permissible range, upper limit (DC)	28.8 V
• Reverse polarity protection	No
<b>Power losses</b>	
Power loss, typ.	4 W
<b>Address area</b>	
Occupied address area	
• Outputs	4 byte
• Inputs	6 byte
<b>Digital inputs</b>	
Number of digital inputs	8; 8 single channel, 4 two-channel
Number of simultaneously controllable inputs	8
Input characteristic curve acc. to IEC 1131, Type 1	Yes
Input voltage	
• Rated value, DC	24 V
• for signal "0"	-30 to +5 V
• for signal "1"	15 to 30 V
Input current	
• for signal "1", typ.	3.7 mA
Input delay (for rated value of input voltage)	
• for standard inputs	Yes
- parameterizable	0.3 ms
- at "0" to "1", min.	17 ms
- at "0" to "1", max.	0.3 ms
- at "1" to "0", min.	17 ms
- at "1" to "0", max.	
Cable length	
• Cable length, shielded, max.	200 m
• Cable length unshielded, max.	200 m
<b>Encoder supply</b>	
Number of outputs	2
Output voltage	min. L+ (-1.5 V)
Output current, rated value	300 mA
Output current, permissible range	0 to 300 mA
Short-circuit protection	Yes; Electronic (response threshold 0.7 A to 1.8 A)
<b>Encoder</b>	
Connectable encoders	
• 2-wire BERS	No
<b>Interrupts/diagnostics/status information</b>	
Alarms	
• Diagnostic alarm	Yes
Diagnoses	
• Diagnostic functions	Yes
• Diagnostic information readable	Yes
• Short circuit	Yes
Diagnostics indication LED	
• Group error SF (red)	Yes
• Status indicator digital input (green)	Yes

Order No.	6ES7 138-4FA04-0AB0
<b>Isolation</b>	
Isolation checked with	500 VDC
<b>Galvanic isolation</b>	
Galvanic isolation digital inputs	
• between the channels	No
• between the channels and the backplane bus	Yes
• between the channels and the load voltage L+	No
<b>Permissible potential difference</b>	
between M internally and the inputs	75 V DC/60 V AC
<b>Standards, approvals, certificates</b>	
Highest safety class achievable in safety mode	
• acc. to EN 954	Cat. 3 (single-channel), Cat. 4 (two-channel)
• acc. to IEC 61508	SIL 2 (single-channel), SIL 3 (two-channel)
<b>Dimensions and weight</b>	
Dimensions	
• Width	30 mm
• Height	81 mm
• Depth	52 mm
Weight	
• Weight, approx.	78 g

Order No.	6ES7 138-4FB03-0AB0
<b>Supply voltages</b>	
Load voltage L+	
• Rated value (DC)	24 V
• Reverse polarity protection	No
<b>Current consumption</b>	
from load voltage L+ (without load), max.	typ. 100 mA
from backplane bus 3.3 V DC, max.	28 mA
<b>Power losses</b>	
Power loss, typ.	3.5 W
<b>Digital outputs</b>	
Number of digital outputs	4
Short-circuit protection	Yes; Electronic
Limitation of inductive shutdown voltage to	Typ. (2L+) -47 V
Lamp load, max.	10 W
Controlling a digital input	No
Output voltage	
• for signal "1", min.	L+ (-2,0 V), current sourcing switch: L+ (-1,5 V), voltage drop on current sinking switch: max. 0.5 V
Output current	
• for signal "1" rated value	2 A
• for signal "1" permissible range for 0 to 60 °C, min.	20 mA
• for signal "1" permissible range for 0 to 60 °C, max.	2.4 A
• for signal "0" residual current, max.	0.5 mA; Current sourcing switch: max. 0.5 mA; current sinking switch: max. 4 mA

# SIMATIC ET 200 fail-safe distributed IO

## SIMATIC ET 200S fail-safe modules

### F electronic modules

Order No.	6ES7 138-4FB03-0AB0
Parallel switching of 2 outputs	
• for increased power	No
• for redundant control of a load	No
Switching frequency	
• with resistive load, max.	30 Hz
• with inductive load, max.	0.1 Hz
• on lamp load, max.	10 Hz
Aggregate current of outputs (per group)	
• horizontal installation	
- up to 40 °C, max.	6 A
- up to 55 °C, max.	5 A
- up to 60 °C, max.	4 A
• vertical installation	
- up to 40 °C, max.	4 A
Load resistance range	
• lower limit	12 Ω
• upper limit	1 kΩ
Cable length	
• Cable length, shielded, max.	200 m
• Cable length unshielded, max.	200 m
<b>Interrupts/diagnostics/status information</b>	
Diagnoses	
• Diagnostic functions	Yes
• Wire break	Yes
• Short circuit	Yes
Diagnostics indication LED	
• Group error SF (red)	Yes
• Status indicator digital output (green)	Yes
<b>Isolation</b>	
Isolation checked with	500 VDC
tested with	
• Channels against backplane bus and load voltage L+	1500 V AC
<b>Galvanic isolation</b>	
Galvanic isolation digital outputs	
• between the channels	No
• between the channels and the backplane bus	Yes
• between the channels and the load voltage L+	No
<b>Standards, approvals, certificates</b>	
Highest safety class achievable in safety mode	
• acc. to EN 954	Cat. 4
• acc. to IEC 61508	SIL 3
<b>Dimensions and weight</b>	
Dimensions	
• Width	30 mm
• Height	81 mm
• Depth	52 mm
Weight	
• Weight, approx.	85 g



# SIMATIC ET 200 fail-safe distributed IO

## SIMATIC ET 200S fail-safe modules

F electronic modules

### Selection and ordering data

	Order No.
<b>Electronic module 4/8 F-DI PROFIsafe 24 V DC</b> 30 mm construction width, up to Category 4 (EN954-1)	<b>6ES7 138-4FA04-0AB0</b>
<b>SIPLUS 4/8 F DI electronic module, PROFIsafe 24 V DC,</b> Same as based-on module (see above), but suitable for extended temperature range and medial exposure	<b>6AG1 138-4FA04-2AB0</b>
<b>Electronic module 4 F-DO PROFIsafe 24 V DC/2A</b> 30 mm construction width, up to Category 4 (EN954-1)	<b>6ES7 138-4FB03-0AB0</b>
<b>SIPLUS4 F-DO electronic module, PROFIsafe 24 V DC/2 A,</b> Same as based-on module (see above), but suitable for extended temperature range and medial exposure	<b>6AG1 138-4FB03-2AB0</b>
<b>Fail-safe digital hybrid module 4 F-DI / 3 F-DO PROFIsafe 24 V DC/2A</b> 30 mm construction width, up to Category 3 (EN954-1) / SIL 2 (IEC 62061)	<b>6ES7 138-4FC01-0AB0</b>
<b>Accessories</b>	
<b>Terminal modules for electronic modules</b>	See F terminal modules
<b>IM 151-1 High Feature interface module</b> for ET 200S; transmission rate up to 12 Mbit/s; max. 63 modules can be connected, with isochronous mode, bus connection via 9-pin Sub-D connector incl. terminating module	<b>6ES7 151-1BA02-0AB0</b>
<b>IM 151-3 PN HF interface module</b> for ET 200S; transfer rate up to 100 Mbit/s; max. 63 I/O modules up to 2 m wide can be connected; 2 x bus connection via RJ45 connector, incl. terminating module	<b>6ES7 151-3BA23-0AB0</b>
<b>IM 151-3 PN FO interface module</b> for ET 200S; 2 PROFINET FO interfaces, integrated 2-port switch, max. 63 I/O modules up to 2 m wide can be connected, incl. terminating module	<b>6ES7 151-3BB23-0AB0</b>
<b>Distributed Safety V5.4 programming tool</b> Task: Software for configuring fail-safe user programs for SIMATIC S7-300F, S7-400F, ET 200S Requirement: STEP 7 V5.3 SP3 and higher Floating license Software Update Service	<b>6ES7 833-1FC02-0YA5</b> <b>6ES7 833-1FC00-0YX2</b>
<b>Distributed Safety Upgrade</b> from V5.x to V5.3; Floating license for 1 user	<b>6ES7 833-1FC02-0YE5</b>

	Order No.
<b>SIMATIC Manual Collection</b> Electronic manuals on DVD, multi-language: S7-200, TD 200, S7-300, M7-300, C7, S7-400, M7-400, STEP 7, Engineering Tools, Runtime Software, SIMATIC DP (Distributed I/O), SIMATIC HMI (Human Machine Interface), SIMATIC NET (Industrial Communication)	<b>6ES7 998-8XC01-8YE0</b>
<b>SIMATIC Manual Collection – Update service for 1 year</b> Scope of delivery: Current DVD "S7 Manual Collection" and the three subsequent updates	<b>6ES7 998-8XC01-8YE2</b>

### Additional Information

#### Brochures

You can download information material in the Internet:

<http://www.siemens.com/simatic/printmaterial>

# SIMATIC ET 200 fail-safe distributed IO

## SIMATIC ET 200S fail-safe modules

### F-electronic modules relays

#### Overview



The digital electronics module 1 F-RO 24 V DC/5A 24 to 230 V AC/5A has the following characteristics

- 1 relay output (2 NO contacts)
- Output current 5 A.
- Rated load voltage 24 V DC and 24 to 230 V AC
- The control circuit of the two safety relays must be routed from the outside to the respective terminals.

The attainable safety integrity level is SIL3 (IEC61508), when the control of the F-RO module is implemented via a fail-safe output (e.g. EM 4F-DO 24 V DC/2A PROFIsafe).

#### Application

The 1 F-RO module can be used in multiple ways, e.g.

- For switching of external voltages
- When floating signals are needed
- For controller enables
- When higher switching capacities (> 2 A) are needed

#### Design

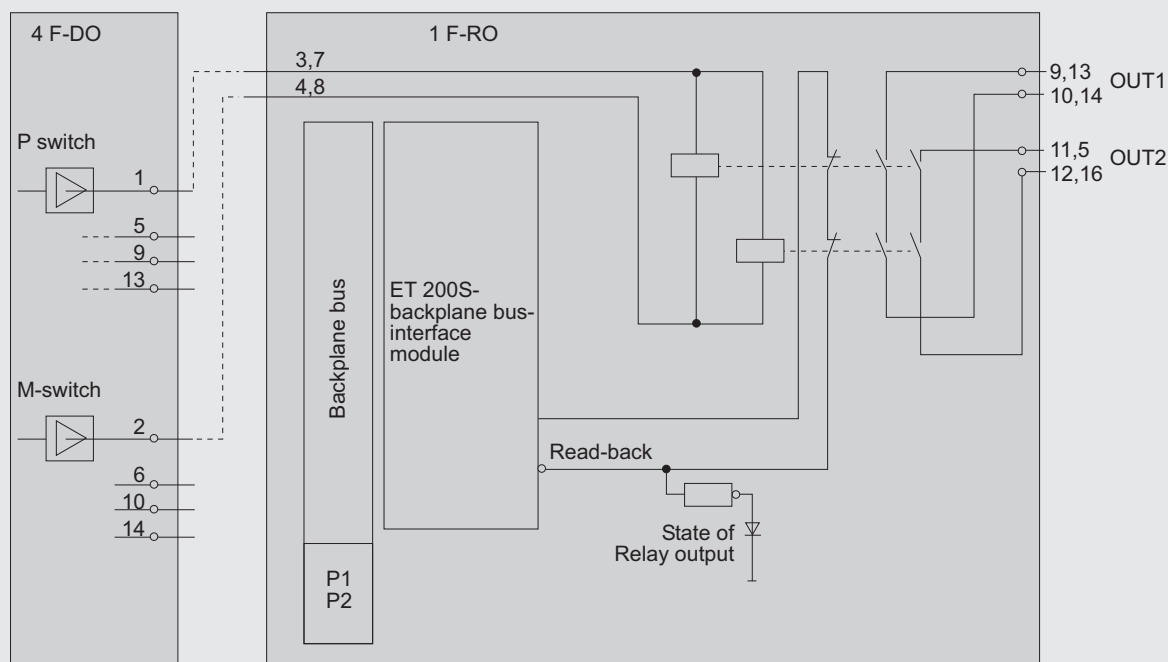

The block diagram shows the control via 4F-DO 24 V DC/2A PROFIsafe (6ES7138-4FB02-0AB0). The control circuit must be routed to the terminals 3, 4 or 7, 8. One channel of the F-DO can also be used for control of multiple F-RO modules (group shutdown).

G\_STT0\_XX\_00035

# SIMATIC ET 200 fail-safe distributed IO

## SIMATIC ET 200S fail-safe modules

### F-electronic modules relays

#### Technical specifications

Order No.	6ES7 138-4FR00-0AA0
<b>Supply voltages</b>	
Load voltage L+	
• Rated value (DC)	24 V; Supply via fail-safe output, e.g. of an F-DO
<b>Current consumption</b>	
from load voltage L+ (without load), max.	100 mA; from control voltage
from backplane bus 3.3 V DC, max.	10 mA
<b>Power losses</b>	
Power loss, typ.	2.1 W
<b>Address area</b>	
Address space per module	
• with packing	2 bit
• without packing	1 byte
<b>Digital inputs</b>	
Cable length	
• Cable length unshielded, max.	10 m; control cable
<b>Digital outputs</b>	
Number of digital outputs	1
Short-circuit protection	No; 6 A external fuse of duty category gL/gG
Controlling a digital input	Yes
Output current	
• for signal "1" rated value	5 A
• for signal "1" minimum load current	5 mA
Switching frequency	
• with resistive load, max.	2 Hz
• with inductive load, max.	0.1 Hz
Aggregate current of outputs (per group)	
• horizontal installation	
- up to 40 °C, max.	8 A
- up to 55 °C, max.	6 A; at 50°C
- up to 60 °C, max.	5 A; up to max. 24.8 V
• vertical installation	
- up to 40 °C, max.	6 A
Cable length	
• Cable length, shielded, max.	200 m
• Cable length unshielded, max.	200 m
<b>Relay outputs</b>	
Switching capacity of contacts	
• Thermal continuous current, max.	5 A
<b>Interrupts/diagnostics/status information</b>	
Diagnostics indication LED	
• Status indicator digital output (green)	Yes
<b>Galvanic isolation</b>	
Galvanic isolation digital outputs	
• between the channels	Yes
• between the channels and the backplane bus	Yes
• between the channels and the load voltage L+	Yes; between channels and control voltage
<b>Standards, approvals, certificates</b>	
Highest safety class achievable in safety mode	
• acc. to EN 954	to Cat. 4
• acc. to IEC 61508	up to SIL 3

Order No.	6ES7 138-4FR00-0AA0
<b>Dimensions and weight</b>	
Dimensions	
• Width	30 mm
• Height	81 mm
• Depth	52 mm
Weight	
• Weight, approx.	90 g

# SIMATIC ET 200 fail-safe distributed IO

## SIMATIC ET 200S fail-safe modules

### F-electronic modules relays

#### Selection and ordering data

	Order No.
<b>Electronics module 1 F-RO</b> 24 V DC/5A 24 ... 230 V AC/5A	<b>6ES7 138-4FR00-0AA0</b>
<i>Accessories</i>	
<b>Terminal modules for electronic modules</b>	See F terminal modules
<b>IM 151-1 High Feature interface module</b>  for ET 200S; transmission rate up to 12 Mbit/s; max. 63 modules can be connected, with isochronous mode, bus connection via 9-pin Sub-D connector incl. terminating module	<b>6ES7 151-1BA02-0AB0</b>
<b>IM 151-3 PN HF interface module</b>  for ET 200S; transfer rate up to 100 Mbit/s; max. 63 I/O modules up to 2 m wide can be connected; 2 x bus connection via RJ45 connector, incl. terminating module	<b>6ES7 151-3BA23-0AB0</b>
<b>IM 151-3 PN FO interface module</b>  for ET 200S; 2 PROFINET FO interfaces, integrated 2-port switch, max. 63 I/O modules up to 2 m wide can be connected, incl. terminating module	<b>6ES7 151-3BB23-0AB0</b>
<b>Distributed Safety V5.4 programming tool</b>  Task: Software for configuring of fail-safe user programs for SIMATIC S7-300F, S7-400F, ET 200S Requirement: STEP 7 V5.3 SP3 and higher  Floating license	<b>6ES7 833-1FC02-0YA5</b>
Software Update Service	<b>6ES7 833-1FC00-0YX2</b>
<b>Distributed Safety Upgrade</b>  from V5.x to V5.3; Floating license for 1 user	<b>6ES7 833-1FC02-0YE5</b>
<b>SIMATIC Manual Collection</b>  Electronic manuals on DVD, multi-language: S7-200, TD 200, S7-300, M7-300, C7, S7-400, M7-400, STEP 7, Engineering Tools, Runtime Software, SIMATIC DP (Distributed I/O), SIMATIC HMI (Human Machine Interface), SIMATIC NET (Industrial Communication)	<b>6ES7 998-8XC01-8YE0</b>
<b>SIMATIC Manual Collection – Update service for 1 year</b>  Scope of delivery: Current DVD S7 Manual Collection* and the three subsequent updates	<b>6ES7 998-8XC01-8YE2</b>

#### Additional Information

##### Brochures

You can download information material in the Internet:

<http://www.siemens.com/simatic/printmaterial>

# SIMATIC ET 200 fail-safe distributed IO

## SIMATIC ET 200S fail-safe modules

### F terminal modules

#### Overview

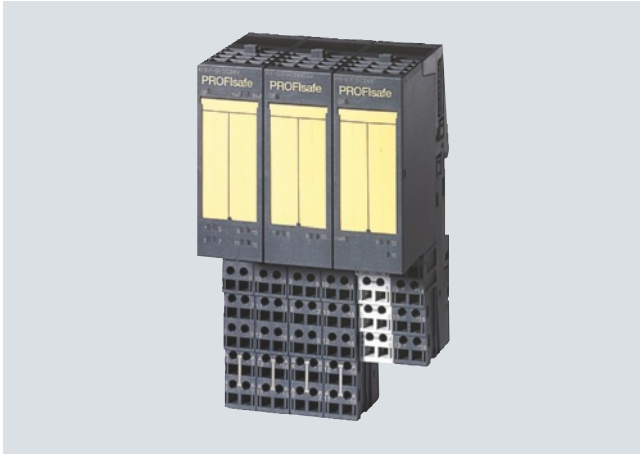

- Mechanical modules as receptacles for the electronic modules
- For setting up permanent wiring through self-configuring voltage buses
- Keyed connection technology to ensure an enhanced vibration resistance of up to 5 g
- Different versions to accommodate power modules and electronic modules
- Replaceable terminal box (even within the station network)
- Automatic coding of the electronic modules
- Self-shielding of the backplane bus for high data security
- Color coding facility for the terminals and for identifying the slot numbers
- Alternatively available with screw-type or spring-loaded terminals
- For up to 60 % faster processafe wiring also with FastConnect connection method (av. soon)

#### Application

Terminal modules are purely mechanical components for configuring the ET 200S. They accommodate the electronic modules and motor starter. The modules are automatically coded.

In the terminal modules, integral, self-configuring voltage buses, communications-capable motor starter and its self-configuring 40 A power bus considerably reduce wiring and control cabinet space requirements. The self-assembling shielding of the backplane bus increases data security.

Rugged construction and molded connections support use in a harsh industrial environment (e.g. vibration resistance up to 5 g).

Terminal modules are available in different versions:

- Terminal modules for power modules TM-P:  
To supply load/encoder voltage on two self-configuring potential buses. A third potential bus (AUX1, max. 230 V) can be used user-specifically, e.g. for continuous supply of light barriers or protective conductors. Power modules are plugged onto TP-M modules for the purpose of voltage monitoring and fusing. Power modules are plugged onto TP-M modules for the purpose of voltage monitoring and fusing. TM-P modules can be used as often as required at any location in the ET 200S. This means that the size of a voltage group can be determined individually. The first module behind the IM151 is always a TM-P with a connected power module

- Terminal modules for electronic modules (TM-E); TM-E modules accept electronic modules (inputs/outputs, technology modules). The unused signal lines of exclusive OR sensors can also be connected. Dedicated double-width terminal modules accept safety-related PROFIsafe electronic modules (F-DI, F-DO and PM E-F).

#### Design

##### TM-P

- Connection through screw-type or spring-loaded terminals
- With or without terminal access to AUX1 rail
- With or without interruption of the AUX1 rail
- Light casing color to allow better differentiation

##### TM-E

- Connection through screw-type or spring-loaded terminals
- With or without terminal access to AUX1 rail
- Connection in 2, 3 or 4-wire technology
- Direct connection of non-equivalent sensors without additional terminal blocks

# SIMATIC ET 200 fail-safe distributed IO

## SIMATIC ET 200S fail-safe modules

### F terminal modules

#### Selection and ordering data

	Order No.
<b>Terminal modules for power modules</b>	
<b>TM-P15S23-A1</b> Ordering unit 1 item 2 x 3 terminals, terminal access to AUX1 bus, AUX1 interconnected to the left, screw-type terminals	<b>6ES7 193-4CC20-0AA0</b>
<b>TM-P15C23-A1</b> Ordering unit 1 item 2 x 3 terminals, terminal access to AUX1 bus, AUX1 interconnected to the left, spring-loaded terminals	<b>6ES7 193-4CC30-0AA0</b>
<b>TM-P15S23-A0</b> Ordering unit 1 item 2 x 3 terminals, terminal access to AUX1 bus, AUX1 interrupted to the left, screw-type terminals	<b>6ES7 193-4CD20-0AA0</b>
<b>TM-P15C23-A0</b> Ordering unit 1 item 2 x 3 terminals, terminal access to AUX1 bus, AUX1 interrupted to the left, spring-loaded terminals	<b>6ES7 193-4CD30-0AA0</b>
<b>TM-P15S22-01</b> Ordering unit 1 item 2 x 2 terminals, no terminal access to AUX1 bus, AUX1 interconnected to the left, screw-type terminals	<b>6ES7 193-4CE00-0AA0</b>
<b>TM-P15C22-01</b> Ordering unit 1 item 2 x 2 terminals, no terminal access to AUX1 bus, AUX1 interconnected to the left, spring-loaded terminals	<b>6ES7 193-4CE10-0AA0</b>
<b>TM-P30S44-A0</b> Ordering unit 1 item 7 x 2 terminals, terminal access to AUX1 bus, AUX1 interrupted to the left, screw-type terminals for PM-E F PROFIsafe	<b>6ES7 193-4CK20-0AA0</b>
<b>TM-P30C44-A0</b> Ordering unit 1 item 7 x 2 terminals, terminal access to AUX1 bus, AUX1 interrupted to the left, spring-loaded terminals for PM-E F PROFIsafe	<b>6ES7 193-4CK30-0AA0</b>
<b>Terminal modules for electronic modules</b>	
<b>TM-E30S44-01</b> Ordering unit 1 item 4 x 4 terminals, no terminal access to AUX1 bus, AUX1 interconnected to the left, screw-type terminals	<b>6ES7 193-4CG20-0AA0</b>
<b>TM-E30C44-01</b> Ordering unit 1 item 4 x 4 terminals, no terminal access to AUX1 bus, AUX1 interconnected to the left, spring-loaded terminals	<b>6ES7 193-4CG30-0AA0</b>
<b>TM-E30S46-A1</b> Ordering unit 1 item 4 x 6 terminals, terminal access to AUX1 bus, AUX1 interconnected to the left, screw-type terminals	<b>6ES7 193-4CF40-0AA0</b>

	Order No.
<b>TM-E30C46-A1</b> Ordering unit 1 item 4 x 6 terminals, terminal access to AUX1 bus, AUX1 interconnected to the left, spring-loaded terminals	<b>6ES7 193-4CF50-0AA0</b>
<b>Accessories</b>	
<b>Color coding plates</b> Ordering unit 200 items for TM-P, TM-E	
<ul style="list-style-type: none"> <li>• white</li> <li>• yellow</li> <li>• yellow/green</li> <li>• red</li> <li>• blue</li> <li>• brown</li> <li>• turquoise</li> </ul>	<ul style="list-style-type: none"> <li><b>6ES7 193-4LA20-0AA0</b></li> <li><b>6ES7 193-4LB20-0AA0</b></li> <li><b>6ES7 193-4LC20-0AA0</b></li> <li><b>6ES7 193-4LD20-0AA0</b></li> <li><b>6ES7 193-4LF20-0AA0</b></li> <li><b>6ES7 193-4LG20-0AA0</b></li> <li><b>6ES7 193-4LH20-0AA0</b></li> </ul>
<b>Grounding terminal</b> Ordering unit 1 item For cable cross-sections up to 25 mm <sup>2</sup>	<b>8WA2 868</b>
<b>3 x 10 mm busbars</b> Ordering unit 1 item	<b>8WA2 842</b>
<b>Labels, inscribed</b> Ordering unit 1 set	
<ul style="list-style-type: none"> <li>• 200 units for slot numbering (1 to 20) 10 x</li> <li>• 200 units for slot numbering (1 to 40) 5 x</li> <li>• 200 units for slot numbering (1 to 64) 1 x, (1 to 68) 2 x</li> </ul>	<ul style="list-style-type: none"> <li><b>8WA8 861-0AB</b></li> <li><b>8WA8 861-0AC</b></li> <li><b>8WA8 861-0DA</b></li> </ul>
<b>Labels, blank</b> 200 units for slot numbering	<b>8WA8 848-2AY</b>

#### Additional Information

##### Brochures

You can download information material in the Internet:

<http://www.siemens.com/simatic/printmaterial>

# SIMATIC ET 200 fail-safe distributed IO

## SIMATIC ET 200pro fail-safe distributed IO

ET 200pro

### Overview

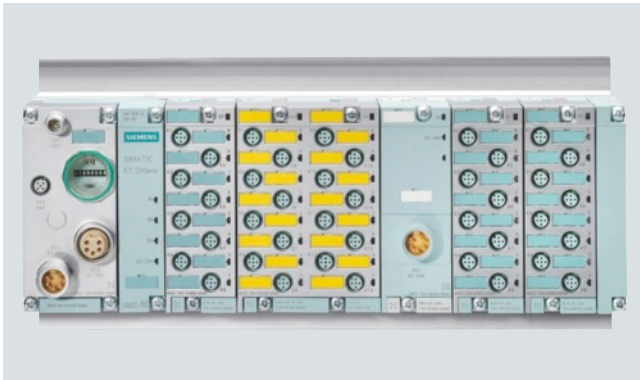

- Distributed I/O system with degree of protection IP65/67 for cabinet-free use at the machine.
- Small, multifunctional complete solution: Digital inputs/outputs, fail-safe modules, motor starters up to 5.5 kW, etc.
- Communication over PROFIBUS or PROFINET
- Mixed arrangement of fail-safe and standard modules in the same station
- Freely selectable connection technique: Direct, ECOFAST or M12 7/8"
- Power module for easy implementation of load groups
- Module replacement during operation (hot swapping)
- Easy installation as well as permanent wiring
- Data transmission rates of up to 12 Mbit/s
- Extensive diagnostics: Module-specific or channel-specific
- Intelligent motor starters for starting and protection of motors and loads up to 5.5 kW
  - Versions: Direct and reversing starters - Standard and High-Feature
- Fail-safe modules with safety-related signal processing according to PROFIsafe

### Application

SIMATIC ET 200pro is the new modular I/O system with high degree of protection IP65/66/67 for local, cabinetless applications. ET 200pro distinguishes itself through a small frame size and an innovative installation concept. ET 200pro can be optimized and very flexibly adapted to the requirements of the corresponding automation task with respect to the connection method, required I/Os and fieldbus connection. New features such as the integrated PROFIsafe safety technology, the PROFINET interface and the ability to hotswap modules permit it to be used for a wide range of applications.

With the integrated motor starters, conveyor applications can be implemented optimally, or drives of up to 5.5 kW can be controlled without control cabinet.

### Design

The tried and tested separation of module and bus/power connection technology, which has already been used for the ET 200eco, is now also used for the digital and analog expansion modules of the ET 200pro. For the interface module this allows use of the T-functionality for the bus and 24 V power supply, and for the expansion modules it permits pre-wiring of sensor/actuator connections. This permanent wiring allows exactly one electronics module to be hot-swapped in the event of a fault without having to switch off the whole station. It can continue to operate fault-free while the module is being replaced. This ensures very high plant availability. When an electronics component is replaced, the whole I/O wiring can

remain on the connecting module and does not have to be marked or removed.

### Modules

The modules of the ET 200pro usually have two or three components. Interface and power modules as well as digital and analog expansion modules comprise:

- one bus connector which constitutes the backplane bus of the system
- one electronics module or interface module
- one connecting module

A backplane bus module is required for operation of motor starters.

A station is constructed from:

- one rack
- one interface module for PROFIBUS DP
- one connecting module for the interface module for PROFIBUS DP
  - CM IM DP direct with up to six M20 screwed cable glands
  - CM IM DP ECOFAST Cu
  - CM IM DP M12 7/8"

Or optionally

- each with an interface module for PROFINET IO
- a terminal module for the PROFINET IO interface module:
  - CM IM PN M12 7/8"
  - CM IM PN 2 x RJ45
  - CM IM PN 2 x SCRJ FO
- max. 16 expansion modules that can be mounted in stations up to 1 m in width

### Expansion modules

The following expansion modules are available:

- Digital I/Os
- Analog inputs
- Analog outputs
- Connecting modules IO
  - CM IO 8 x M8 for digital electronic modules
  - CM IO 4 x M12 inverse for digital electronic modules
  - CM IO 4x M12 for digital or analog electronic modules
  - CM IO 8x M12 for digital electronic modules
- Power module electronics
- Connecting modules for power modules
  - CM PM-E PP (Push Pull)
  - CM PM-E directly with up to two M20 screwed cable glands
  - CM PM-E ECOFAST Cu
  - CM PM-E 7/8"
- Motor starter

3

# SIMATIC ET 200 fail-safe distributed IO

## SIMATIC ET 200pro fail-safe distributed IO

### ET 200pro

#### Rack

Two different racks are available for mounting the ET 200pro:

- **Narrow rack** The narrow rack supports complete pre-assembly on the workbench by means of two mounting flanges outside of the ET 200pro station.



- **Compact rack** When the compact rack is used, the small footprint of the ET 200pro system can be used to best advantage.



#### Function

The SIMATIC ET 200pro is easily configured with STEP 7. A GSD file is available for interfacing with systems of other manufacturers.

#### Technical specifications

General technical specifications	ET 200pro
Electronic modules	<ul style="list-style-type: none"> <li>• Digital inputs/outputs</li> <li>• Analog inputs</li> <li>• Analog outputs</li> </ul>
<b>Motor starter</b>	
Cables and connections	M12 and M8 round connector with standard assignment for actuator/sensor
Transmission rate, max.	12 Mbit/s (PROFIBUS DP), 100 Mbit/s (PROFINET IO)
Supply voltage	24 V DC
Current consumption of one ET 200pro (internal and encoder supply, non-switched voltage), up to 55 °C, max.	≤ 5 A
Current consumption of one ET 200pro per infeed (IM, PM, switched voltage, up to 55 °C, max.)	10 A
For overall configuration with looping through (several ET 200pro), up to 55 °C, max.	16 A (with connecting module, directly)
Degree of protection	IP65/66/IP67 for interface, digital and analog modules
Material	Thermoplastic (reinforced with glass fiber)
<b>Ambient conditions</b>	
Temperature	from 0 ... 55 °C (-25 °C on request)
Relative humidity	from 5 ... 100%
Atmospheric pressure	from 795 ... 1080 hPa
<b>Mechanical stress</b>	
• Vibrations	Vibration test conforming to IEC 60068, Part 2-6 (sinusoidal) <ul style="list-style-type: none"> <li>• Constant acceleration 5 g, occasionally 10 g for interface, digital and analog modules</li> <li>• 2 g motor starters</li> </ul>
• Shock	Shock test according to IEC 680068 Part 2 - 27, half-sine, 30 g, 18 ms duration for interface, digital and analog modules <ul style="list-style-type: none"> <li>• 15 g, 11 ms duration for motor starters</li> </ul>
Approvals	UL, CSA or cULus



# SIMATIC ET 200 fail-safe distributed IO

## SIMATIC ET 200pro fail-safe distributed IO

### IM154-2 High Feature interface module

#### Overview



Interface modules for handling communication between the ET 200pro and the higher-level master over PROFIBUS DP.

#### Application

The IM 154-1 DP and IM 154-2 DP High Feature interface modules handle the communication between the ET 200pro and higher-level masters over PROFIBUS DP.

#### Design

Connecting modules for DP interface modules (must be ordered separately):

- CM IM DP direct
- CM IM DP ECOFAST Cu
- CM IM DP M12 7/8"

All connecting modules contain a PROFIBUS address adjuster that is visible and adjustable from the outside as well as a selectable, segmenting terminating resistor.

The IM 154-2 DP High Feature interface module must be implemented in PROFIsafe applications.

#### Function

The IM 154-2 DP High Feature interface module is configured using STEP 7 V5.3 SP3. A hardware support package is available for STEP 7 V5.3 SP2 and higher.

Integration into older versions is possible via GSD.

#### Technical specifications

Order no.	6ES7 154-2AA01-0AB0
<b>Supply voltages</b>	
Supply voltage of electronics 1L+	24 V
• Rated value (DC)	Yes; over exchangeable fuses
• Short-circuit protection	Yes; against destruction
• Reverse polarity protection	
Rated value	
• 24 V DC	Yes
• permissible range, lower limit (DC)	20.4 V
• permissible range, upper limit (DC)	28.8 V
<b>Current consumption</b>	
from supply voltage 1L+, max.	200 mA
<b>Power losses</b>	
Power loss, typ.	5 W

Order no.	6ES7 154-2AA01-0AB0
<b>Address area</b>	
Addressing volume	
• Outputs	244 byte
• Inputs	244 byte
<b>PROFIBUS DP</b>	
Automatic detection of transmission speed	Yes
<b>1st interface</b>	
Type of interface	PROFIBUS DP
Physics	RS 485
Functionality	
• DP slave	Yes
DP slave	
• Services	
- SYNC/FREEZE	Yes
- Direct data exchange (slave-to-slave communication)	Yes
• Transmission rate, min.	9.6 kbit/s
• Transmission rate, max.	12 Mbit/s
<b>Parameter</b>	
DPV1 operation	possible
Process alarm	parameterizable
Swapping interrupt	parameterizable
Startup if setpoint not equal to actual configuration	parameterizable
<b>Interrupts/diagnostics/status information</b>	
Diagnostics indication LED	
• Bus fault BF (red)	Yes
• Group error SF (red)	Yes
• Monitoring 24 V voltage supply ON (green)	Yes
• Load voltage monitoring DC 24 V (green)	Yes
<b>Isolation</b>	
Isolation checked with	500 VDC
<b>Galvanic isolation</b>	
between supply voltage and electronics	Yes
<b>Environmental requirements</b>	
Operating temperature	
• Min.	-25 °C
• max.	55 °C
Storage/transport temperature	
• Min.	-40 °C
• max.	70 °C
<b>Degree of protection</b>	
IP67	Yes
<b>General information</b>	
Vendor identification (VendorID)	8119H
<b>Dimensions and weight</b>	
Dimensions	
• Width	90 mm
• Height	130 mm
• Depth	59.3 mm
Weight	
• Weight, approx.	375 g

# SIMATIC ET 200 fail-safe distributed IO

## SIMATIC ET 200pro fail-safe distributed IO

### IM154-2 High Feature interface module

#### Selection and ordering data

	Order No.
<b>IM154-2 High Feature interface module</b> For ET 200pro; for communication between ET 200pro and higher-level masters over PROFIBUS DP; support of PROFIsafe	<b>6ES7 154-2AA01-0AB0</b>
<i>Accessories</i>	
<b>CM IM DP ECOFAST connection module</b> For connecting PROFIBUS DP and the 24 V power supply to PROFIBUS interface modules, 2 ECOFAST Cu connections	<b>6ES7 194-4AA00-0AA0</b>
<b>CM IM DP direct connection module</b> For connecting PROFIBUS DP and the 24 V power supply directly to the PROFIBUS interface modules, up to six M20 screwed cable glands	<b>6ES7 194-4AC00-0AA0</b>
<b>CM IM DP M12, 7/8" connection module</b> For connecting PROFIBUS DP and the 24 V power supply to PROFIBUS interface modules, 2 x M12 and 2 x 7/8"	<b>6ES7 194-4AD00-0AA0</b>
<i>Zubehör für CM IM DP ECOFAST</i>	
<b>PROFIBUS ECOFAST hybrid cable, preassembled</b> With 2 ECOFAST connectors, trailing-type cable 2 x CU 0.64 mm <sup>2</sup> and 4 x Cu 1.5 mm <sup>2</sup> <ul style="list-style-type: none"> <li>• 1.5 m long</li> <li>• 3.0 m long</li> <li>• 5.0 m long</li> <li>• 10 m long</li> <li>• 15 m long</li> <li>• 20 m long</li> <li>• 25 m long</li> <li>• 30 m long</li> <li>• 35 m long</li> <li>• 40 m long</li> <li>• 45 m long</li> <li>• 50 m long</li> </ul>	<b>6XV1 830-7BH15</b> <b>6XV1 830-7BH30</b> <b>6XV1 830-7BH50</b> <b>6XV1 830-7BN10</b> <b>6XV1 830-7BN15</b> <b>6XV1 830-7BN20</b> <b>6XV1 830-7BN25</b> <b>6XV1 830-7BN30</b> <b>6XV1 830-7BN35</b> <b>6XV1 830-7BN40</b> <b>6XV1 830-7BN45</b> <b>6XV1 830-7BN50</b>
<b>PROFIBUS ECOFAST hybrid cable GP, preassembled</b> With 2 ECOFAST connectors, trailing-type cable 2 x CU 0.64 mm <sup>2</sup> and 4 x Cu 1.5 mm <sup>2</sup> <ul style="list-style-type: none"> <li>• 1.5 m long</li> <li>• 3.0 m long</li> <li>• 5.0 m long</li> <li>• 10 m long</li> <li>• 15 m long</li> <li>• 20 m long</li> <li>• 25 m long</li> <li>• 30 m long</li> <li>• 35 m long</li> <li>• 40 m long</li> <li>• 45 m long</li> <li>• 50 m long</li> </ul>	<b>6XV1 860-3PH15</b> <b>6XV1 860-3PH30</b> <b>6XV1 860-3PH50</b> <b>6XV1 860-3PN10</b> <b>6XV1 860-3PN15</b> <b>6XV1 860-3PN20</b> <b>6XV1 860-3PN25</b> <b>6XV1 860-3PN30</b> <b>6XV1 860-3PN35</b> <b>6XV1 860-3PN40</b> <b>6XV1 860-3PN45</b> <b>6XV1 860-3PN50</b>

	Order No.
<b>PROFIBUS ECOFAST hybrid cable, non-assembled</b> Trailing-type cable 2 x CU 0.64 mm <sup>2</sup> and 4 x Cu 1.5 mm <sup>2</sup> <ul style="list-style-type: none"> <li>• 50 m long</li> <li>• 100 m long</li> </ul>	<b>6XV1 830-7AN50</b> <b>6XV1 830-7AT10</b>
<b>PROFIBUS ECOFAST hybrid cable GP, non-assembled</b> Trailing-type cable 2 x CU 0.64 mm <sup>2</sup> and 4 x Cu 1.5 mm <sup>2</sup> <ul style="list-style-type: none"> <li>• 50 m long</li> <li>• 100 m long</li> </ul>	<b>6XV1 860-4PN50</b> <b>6XV1 860-4PT10</b>
<b>PROFIBUS ECOFAST hybrid connector 180</b> ECOFAST Cu, 2 x Cu, 4 x 1.5 mm <sup>2</sup> , HANBRID connector <ul style="list-style-type: none"> <li>• with male insert, 5 per pack</li> <li>• with female insert, 5 per pack</li> </ul>	<b>6GK1 905-0CA00</b> <b>6GK1 905-0CB00</b>
<b>PROFIBUS ECOFAST hybrid connector angular</b> ECOFAST Cu, 2 x Cu, 4 x 1.5 mm <sup>2</sup> , HANBRID connector <ul style="list-style-type: none"> <li>• with male insert, 5 per pack</li> <li>• with female insert, 5 per pack</li> </ul>	<b>6GK1 905-0CC00</b> <b>6GK1 905-0CD00</b>
<i>Accessories for CM IM DP direct</i>	
<b>PROFIBUS trailing cable</b> Max. acceleration 4 m/s <sup>2</sup> , at least 3,000,000 bending cycles, bending radius 60 mm, 2-core shielded, sold by the meter, minimum order quantity 20 m, maximum order quantity 1,000 m	<b>6XV1 830-3EH10</b>
<b>PROFIBUS FC Food bus cable</b> With PE sheath for use in the food and beverages industry, 2-core, shielded, sold by the meter, minimum order quantity 20 m, maximum order quantity 1,000 m	<b>6XV1 830-0GH10</b>
<b>PROFIBUS FC Robust bus cable</b> With PUR sheath for use under conditions of extreme mechanical stress and aggressive chemicals, 2-core, shielded, sold by the meter, minimum order quantity 20 m, maximum order quantity 1,000 m	<b>6XV1 830-0JH10</b>
<b>Power line</b> 5-core, 5 x 1.5 mm <sup>2</sup> , trailing type, sold by the meter, minimum order quantity 20 m, maximum order quantity 1,000 m	<b>6XV1 830-8AH10</b>
<i>Accessories for CM IM DP M12, 7/8"</i>	
<b>PROFIBUS M12 connecting cable</b> Preassembled with two M12 connectors, 5-pin <ul style="list-style-type: none"> <li>• 1.5 m long</li> <li>• 2.0 m long</li> <li>• 3.0 m long</li> <li>• 5.0 m long</li> <li>• 10 m long</li> <li>• 15 m long</li> </ul>	<b>6XV1 830-3DH15</b> <b>6XV1 830-3DH20</b> <b>6XV1 830-3DH30</b> <b>6XV1 830-3DH50</b> <b>6XV1 830-3DN10</b> <b>6XV1 830-3DN15</b>

# SIMATIC ET 200 fail-safe distributed IO

## SIMATIC ET 200pro fail-safe distributed IO

### IM154-2 High Feature interface module

	Order No.
<b>7/8" connecting cable to power supply</b> 5-core, 5 x 1.5 mm <sup>2</sup> , trailing type, preassembled with two 7/8" connectors, 5-pin <ul style="list-style-type: none"> <li>• 1.5 m long</li> <li>• 2.0 m long</li> <li>• 3.0 m long</li> <li>• 5.0 m long</li> <li>• 10 m long</li> <li>• 15 m long</li> </ul>	<b>6XV1 822-5BH15</b> <b>6XV1 822-5BH20</b> <b>6XV1 822-5BH30</b> <b>6XV1 822-5BH50</b> <b>6XV1 822-5BN10</b> <b>6XV1 822-5BN15</b>
<b>M12 cable connector</b> For ET 200eco, with axial cable outlet <ul style="list-style-type: none"> <li>• with male insert, 5 per pack</li> <li>• with female insert, 5 per pack</li> </ul>	<b>6GK1 905-0EA00</b> <b>6GK1 905-0EB00</b>
<b>PROFIBUS M12 bus termination connector</b> with pin insert	<b>6GK1 905-0EC00</b>
<b>7/8" cable connector</b> For ET 200eco, with axial cable outlet <ul style="list-style-type: none"> <li>• with male insert, 5 per pack</li> <li>• with female insert, 5 per pack</li> </ul>	<b>6GK1 905-0FA00</b> <b>6GK1 905-0FB00</b>
<b>M12 sealing cap</b> For protection of unused M12 connections with ET 200pro	<b>3RX9 802-0AA00</b>
<b>Sealing cap 7/8"</b> For protecting unused 7/8" connections for ET 200pro; 10 items per pack	<b>6ES7 194-3JA00-0AA0</b>
<b>General accessories</b>	
<b>ET 200pro rack</b> <ul style="list-style-type: none"> <li>• Narrow, for interface, electronics and power modules               <ul style="list-style-type: none"> <li>- 500 mm</li> <li>- 1000 mm</li> <li>- 2000 mm, can be cut to length</li> </ul> </li> <li>• Compact, for interface, electronics and power modules               <ul style="list-style-type: none"> <li>- 500 mm</li> <li>- 1000 mm</li> <li>- 2000 mm, can be cut to length</li> </ul> </li> <li>• Wide, for interface, electronics, power modules and motor starters               <ul style="list-style-type: none"> <li>- 500 mm</li> <li>- 1000 mm</li> <li>- 2000 mm, can be cut to length</li> </ul> </li> <li>• Wide, for I/O modules and motor starters               <ul style="list-style-type: none"> <li>- 500 mm</li> <li>- 1000 mm</li> <li>- 2000 mm</li> </ul> </li> </ul>	<b>6ES7 194-4GA00-0AA0</b> <b>6ES7 194-4GA60-0AA0</b> <b>6ES7 194-4GA20-0AA0</b>  <b>6ES7 194-4GC70-0AA0</b> <b>6ES7 194-4GC60-0AA0</b> <b>6ES7 194-4GC20-0AA0</b>  <b>6ES7 194-4GB00-0AA0</b> <b>6ES7 194-4GB60-0AA0</b> <b>6ES7 194-4GB20-0AA0</b>  <b>6ES7 194-4GD00-0AA0</b> <b>6ES7 194-4GD10-0AA0</b> <b>6ES7 194-4GD20-0AA0</b>
<b>Spare fuse</b> 12.5 A quick-response, for interface and power modules, 10 items per package unit	<b>6ES7 194-4HB00-0AA0</b>
<b>PROFIBUS Fast Connect bus cable</b> Standard type with special design for fast assembly, 2-core, shielded, sold by the meter; max. length that can be supplied 1000 m, minimum order quantity 20 m	<b>6XV1 830-0EH10</b>

	Order No.
<b>PROFIBUS Hybrid Standard Cable GP</b> Standard PROFIBUS hybrid cable with 2 energy cables (1.5 mm <sup>2</sup> ) for supplying data and energy for ET 200pro	<b>6XV1 860-2R</b>
<b>Technical product data</b> For CAX applications, one-off license	<b>6ES7 991-0CD01-0YX0</b>
<b>SIMATIC Manual Collection</b> Electronic manuals on DVD, multi-language: S7-200, TD 200, S7-300, M7-300, C7, S7-400, M7-400, STEP 7, Engineering Tools, Runtime Software, SIMATIC DP (Distributed I/O), SIMATIC HMI (Human Machine Interface), SIMATIC NET (Industrial Communication)	<b>6ES7 998-8XC01-8YE0</b>
<b>SIMATIC Manual Collection – Update service for 1 year</b> Scope of delivery: Current DVD "S7 Manual Collection" and the three subsequent updates	<b>6ES7 998-8XC01-8YE2</b>

# SIMATIC ET 200 fail-safe distributed IO

## SIMATIC ET 200pro fail-safe distributed IO

### IM 154-4 PN High Feature interface module

#### Overview



Interface module for processing the communication between ET 200pro and a higher-level controller over PROFINET IO.

#### Application

The IM 154-4 PN High Feature interface module handles the communication between ET 200pro and the higher-level PLC over PROFINET IO.

#### Design

The interface module contains a 2-port switch required for linear bus topologies and for communication. PROFIsafe applications are also possible in combination with this module.

Connection modules for the IM 154-4 PN interface module (to be ordered separately):

- CM IM PN M12, 7/8"
- CM IM PN 2XRJ45
- CM IM PN 2XSCRJ FO

#### Function

The IM 154-4 PN High Feature interface modules are configured using STEP 7 V5.4. The module can be configured using a hardware support package from STEP 7 V5.3 SP3. A GSD file allows it to be integrated into older versions of STEP 7.

#### Technical specifications

Order No.	6ES7 154-4AB10-0AB0
<b>Supply voltages</b>	
Supply voltage of electronics 1L+	
• Rated value (DC)	24 V
• Short-circuit protection	Yes; Fuse in lower part is exchangeable, the fuse on the IM-LP is not
• Reverse polarity protection	Yes; against destruction
Rated value	
• 24 V DC	Yes
• permissible range, lower limit (DC)	20.4 V; Unit [V]
• permissible range, upper limit (DC)	28.8 V; Unit [V]
<b>Current consumption</b>	
from backplane bus 3.3 V DC, max.	Not applicable
from supply voltage 1L+, max.	400 mA; Dependent on terminal module, typ. maximum value for FO connection method, full load on RWB and 20.4 V input voltage

Order No.	6ES7 154-4AB10-0AB0
<b>Power losses</b>	
Power loss, typ.	6 W; Dependent on terminal module, typ. maximum value for CU connection method, full load on RWB, for FO the value is approx. 0.7 W higher
<b>Memory</b>	
Micro Memory Card	No; Internal memory medium
<b>Address area</b>	
Addressing volume	
• Outputs	256 byte
• Inputs	256 byte
<b>Interfaces</b>	
automatic detection of transmission speed	Yes
<b>Protocols</b>	
PROFINET IO	Yes
<b>PROFINET IO</b>	
Transmission rate, max.	100 Mbit/s
Services	ARP, PING, SNMP
<b>Parameter</b>	
Diagnostic alarm	1
Process alarm	1
Swapping interrupt	1
identifier-related diagnostic data	1
Module status	1
Channel-related diagnostics	1
Startup if setpoint not equal to actual configuration	1
Hot swapping of modules	1
<b>Interrupts/diagnostics/status information</b>	
Diagnostics indication LED	
• Bus fault BF (red)	Yes; Additional LEDs (MAINT, P1/2 LINK, P1/2 RX/TX) available
• Group error SF (red)	Yes
• Monitoring 24 V voltage supply ON (green)	Yes
• Load voltage monitoring DC 24 V (green)	Yes
<b>Isolation</b>	
Isolation checked with	500 VDC
<b>Galvanic isolation</b>	
between backplane bus and electronics	No
between supply voltage and electronics	Yes
<b>Environmental requirements</b>	
Operating temperature	
• Min.	-25 °C
• max.	55 °C
Storage/transport temperature	
• Min.	-40 °C
• max.	70 °C
<b>Degree of protection</b>	
IP65	Yes
IP66	Yes
IP67	Yes
<b>General information</b>	
Vendor identification (VendorID)	0x002A
Device identifier (DeviceID)	0x0305

# SIMATIC ET 200 fail-safe distributed IO

## SIMATIC ET 200pro fail-safe distributed IO

### IM 154-4 PN High Feature interface module

Order No.	6ES7 154-4AB10-0AB0
<b>Dimensions and weight</b>	
Dimensions	
• Width	90 mm
• Height	130 mm
• Depth	59.3 mm
Weight	
• Weight, approx.	490 g

#### Selection and ordering data

	Order No.
<b>IM 154-4 PN High Feature interface module</b>	<b>6ES7 154-4AB10-0AB0</b>
For communication between ET 200pro and higher-level controllers over PROFINET IO; support of PROFIsafe	
<b>Accessories</b>	
<b>CM IM PN connection module M12, 7/8"</b>	<b>6ES7 194-4AJ00-0AA0</b>
For connecting PROFINET PN and 24 V power supply to PROFINET interface modules, 2 x M12 and 2 x 7/8"	
<b>CM IM PN connection module 2xRJ45</b>	<b>6ES7 194-4AF00-0AA0</b>
For connecting PROFINET PN and 24 V power supply to PROFINET interface modules, 2 x RJ45 and 2 x push-pull power connector	
<b>CM IM PN 2xSCRJ FO connection module</b>	<b>6ES7 194-4AG00-0AA0</b>
For connecting PROFINET PN and 24 V power supply to PROFINET interface modules, 2 x SCRJ FO and 2 x push-pull power connector	
<b>M12 sealing cap</b>	<b>3RX9 802-0AA00</b>
For protection of unused M12 connections with ET 200pro	
<b>IE M12 connecting cables</b>	
Preassembled, with two M12 connectors, up to 85 m	
• 0.3 m long	<b>6XV1 870-8AE30</b>
• 0.5 m long	<b>6XV1 870-8AE50</b>
• 1.0 m long	<b>6XV1 870-8AH10</b>
• 1.5 m long	<b>6XV1 870-8AH15</b>
• 2.0 m long	<b>6XV1 870-8AH20</b>
• 3.0 m long	<b>6XV1 870-8AH30</b>
• 5.0 m long	<b>6XV1 870-8AH50</b>
• 10 m long	<b>6XV1 870-8AN10</b>
• 15 m long	<b>6XV1 870-8AN15</b>
• Other special lengths with 90° or 180° cable outlet	See <a href="http://support.automation.siemens.com/WWW/view/en/26999294">http://support.automation.siemens.com/WWW/view/en/26999294</a>
<b>7/8" sealing caps</b>	<b>6ES7 194-3JA00-0AA0</b>
1 pack = 10 units	

	Order No.
<b>7/8" connecting cable to power supply</b>	
5-core, 5 x 1.5 mm <sup>2</sup> , trailing type, preassembled with two 7/8" connectors, 5-pin, up to 50 m	
• 1.5 m long	<b>6XV1 822-5BH15</b>
• 2.0 m long	<b>6XV1 822-5BH20</b>
• 3.0 m long	<b>6XV1 822-5BH30</b>
• 5.0 m long	<b>6XV1 822-5BH50</b>
• 10 m long	<b>6XV1 822-5BN10</b>
• 15 m long	<b>6XV1 822-5BN15</b>
• Other special lengths with 90° or 180° cable outlet	See <a href="http://support.automation.siemens.com/WWW/view/en/26999294">http://support.automation.siemens.com/WWW/view/en/26999294</a>
<b>Power line</b>	<b>6XV1 830-8AH10</b>
5-core, 5 x 1.5 mm <sup>2</sup> , trailing type, sold by the meter, minimum order quantity 20 m, maximum order quantity 1,000 m	
<b>7/8" cable connector</b>	
For ET 200eco, with axial cable outlet	
• with male insert, 5 per pack	<b>6GK1 905-0FA00</b>
• with female insert, 5 per pack	<b>6GK1 905-0FB00</b>
<b>Industrial Ethernet FastConnect installation cables</b>	
• <b>IE FC TP Standard Cable GP 2 x 2:</b>	<b>6XV1 840-2AH10</b>
Sold by the meter, max. order quantity 1000 m; Minimum order quantity 20 m	
• <b>IE FC TP Trailing Cable 2 x 2:</b>	<b>6XV1 840-3AH10</b>
Sold by the meter, max. order quantity 1000 m; Minimum order quantity 20 m	
• <b>IE FC TP Trailing Cable GP 2 x 2:</b>	<b>6XV1 870-2D</b>
Sold by the meter, max. order quantity 1000 m; Minimum order quantity 20 m	
• <b>IE TP Torsion Cable GP 2 x 2:</b>	<b>6XV1 870-2F</b>
Sold by the meter, max. order quantity 1000 m; Minimum order quantity 20 m	
• <b>IE FC TP Marine Cable 2 x 2:</b>	<b>6XV1 840-4AH10</b>
Sold by the meter, max. order quantity 1000 m; Minimum order quantity 20 m	
<b>IE RJ45 Plug PRO</b>	<b>6GK1901-1BB10-6AA0</b>
RJ45 plug in IP65/67-rated design for on-site assembly, plastic housing, insulation/displacement connection system, for SCALANCE X-200IRT PRO and ET200pro: 1 pack = 1 unit	
<b>IE SC RJ POF Plug PRO</b>	<b>6GK1900-0MB00-6AA0</b>
SC RJ plug for POF fibers in IP65/67-rated design for on-site assembly, plastic housing, for SCALANCE X-200IRT PRO and ET200pro 1 pack = 1 unit	
<b>IE SC RJ PCF Plug PRO</b>	<b>6GK1900-0NB00-6AA0</b>
SC RJ plug for PCF fibers in IP65/67-rated design for on-site assembly, plastic housing, for SCALANCE X-200IRT PRO 1 pack = 1 unit	

# SIMATIC ET 200 fail-safe distributed IO

## SIMATIC ET 200pro fail-safe distributed IO

### IM 154-4 PN High Feature interface module

	Order No.
<b>Power Plug PRO</b> 5-pole power plug for 2 x 24 V power supply in IP65/67-rated design, for on-site assembly, plastic housing, for SCALANCE X-200IRT and ET200 pro 1 pack = 1 unit	<b>6GK1907-0AB10-6AA0</b>
<b>IE panel feedthrough</b> Control cabinet feedthrough for converting M12 D-coded connection system (IP65) to RJ45 connection system (IP20) • 1 pack = 5 units	<b>6GK1 901-0DM20-2AA5</b>
<b>Push-Pull cable connector</b> For 1L+/ 2L+, unassembled	<b>6GK1 907-0AB10-6AA0</b>
<b>Cover caps for Push-Pull RJ45 female connectors</b> 5 items per pack	<b>6ES7 194-4JD50-0AA0</b>
<i>General accessories</i>	
<b>ET 200pro rack</b> • Narrow, for interface, electronics and power modules - 500 mm - 1000 mm - 2000 mm, can be cut to length • Compact, for interface, electronics and power modules - 500 mm - 1000 mm - 2000 mm, can be cut to length • Wide, for interface, electronics, power modules and motor starters - 500 mm - 1000 mm - 2000 mm, can be cut to length • Wide, for I/O modules and motor starters - 500 mm - 1000 mm - 2000 mm	<b>6ES7 194-4GA00-0AA0</b> <b>6ES7 194-4GA60-0AA0</b> <b>6ES7 194-4GA20-0AA0</b>  <b>6ES7 194-4GC70-0AA0</b> <b>6ES7 194-4GC60-0AA0</b> <b>6ES7 194-4GC20-0AA0</b>  <b>6ES7 194-4GB00-0AA0</b> <b>6ES7 194-4GB60-0AA0</b> <b>6ES7 194-4GB20-0AA0</b>  <b>6ES7 194-4GD00-0AA0</b> <b>6ES7 194-4GD10-0AA0</b> <b>6ES7 194-4GD20-0AA0</b>
<b>Spare fuse</b> 12.5 A quick-response, for interface and power modules, 10 items per package unit	<b>6ES7 194-4HB00-0AA0</b>
<b>SIMATIC Manual Collection</b> Electronic manuals on DVD, multi-language: S7-200, TD 200, S7-300, M7-300, C7, S7-400, M7-400, STEP 7, Engineering Tools, Runtime Software, SIMATIC DP (Distributed I/O), SIMATIC HMI (Human Machine Interface), SIMATIC NET (Industrial Communication)	<b>6ES7 998-8XC01-8YE0</b>
<b>SIMATIC Manual Collection – Update service for 1 year</b> Scope of delivery: Current DVD "S7 Manual Collection" and the three subsequent updates	<b>6ES7 998-8XC01-8YE2</b>

# SIMATIC ET 200 fail-safe distributed IO

## SIMATIC ET 200pro fail-safe distributed IO

IM 154-6 PN IWLAN

### Overview



Interface module for handling communication between ET 200pro and host PROFINET IO controllers over Industrial Wireless LAN (IWLAN) radio networks for 2.4 GHz or 5 GHz with data transfer rates up to 54 Mbit/s.

- Protection against illegal access, espionage, tapping and falsification through use of effective encryption mechanisms
- Fast exchange of devices through use of interchangeable medium MICRO MEMORY CARD

### Application

The IM 154-6 PN HF IWLAN interface module handles communication between ET 200pro and host PROFINET IO controllers over Industrial Wireless LAN (IWLAN) radio networks for 2.4 GHz or 5 GHz.

It permits the use of an ET 200pro for applications in which a cabled solution can only be implemented at high cost (wear, distance, inaccessible terrain).

Possible fields of application include:

- Automatic guided vehicle systems
- Escalators
- Warehouse logistics
- Goods transportation
- Electric overhead conveyors
- Building management
- Service applications

The IM 154-6 PN HF IWLAN interface module communicates via Industrial Wireless LAN Access Points with PROFINET IO controllers which respond in accordance with the IEC 61158 standard.

### Design

The IM 154-6 PN HF interface module IWLAN consists of:

- an interface unit (IWLAN radio card; compatible with IEEE 802.11a/h/b/g and IEEE 802.11e/i) and
- a connection unit

The interface unit and the connection unit are supplied together with the terminating module.

By means of a screw connection (R-SMA), antennas can be connected directly or also remotely to the interface module.

Device names as well as the user and configuration data can be saved on a SIMATIC Micro Memory Card.

### Function

The IM 154-6 PN HF IWLAN interface module communicates with host systems. It is an IWLAN station, and exchanges data via access points. It can move freely within the radio field.

In addition to a reliable radio link, the IM 154-6 PN HF IWLAN interface module has the following features:

- IEEE 802.11b/ g/ a for different frequency bands
- IEEE 802.11h for different frequency bands 1)
- IEEE 802.11e for multimedia, wireless multimedia (WMM)
- IEEE 802.11i for security
- Maximum transmission rate (gross data transfer rate) 54 Mbit/s
- Transmission methods (physical layer)
  - Direct Sequence Spread Spectrum (DSSS)
  - Complementary Code Keying (CCK)
  - Orthogonal Frequency Division Multiplexing (OFDM)
- Frequency bands / channels
  - 2.4 – 2.4835 GHz / 13 or 11
  - 5.15 – 5.25 GHz / 4
  - 5.25 – 5.35 GHz / 4 <sup>1)</sup>
  - 5.47 – 5.725 GHz / 11 <sup>1)</sup>
  - 5.745 – 5.825 GHz / 5
- Supported Industrial Wireless LAN services
  - Optimized media access with Industrial Point Coordination Function (iPCF)
  - Interruption-free swapping of radio cell with Rapid Roaming (RR)
  - Fault suppression mechanisms with Dynamic Frequency Selection (DFS) <sup>1)</sup> and Transmission Power Control (TPC)
- Use of two antennas for optimization of data transmission

### Security

A high degree of data security is achieved using the WPA2/IEEE 802.11i mechanisms. Modern procedures are defined here which control the regular replacement of the complete 128-bit keys and also provide access control (authentication) for a participant. Data encryption is carried out in accordance with the Advanced Encryption Standard (AES).

1) Not valid for 6ES7 154-6AB50-0AB0

### Technical specifications

IM 154-6 PN IWLAN interface module	6ES7 154-6AB00-0AB0 6ES7 154-6AB50-0AB0
Supply voltage for electronic components 1L+	
• Rated value	24 V DC
• Valid range, lower limit	20.4 V DC
• Valid range, upper limit	28.8 V DC
• Short-circuit protection	Yes; replaceable fuse
• Reverse polarity protection	Yes; against destruction
• Max. infeed current	5 A
Load voltage 2L+	
• Rated value (DC)	24 V DC
• Lower limit of permissible range (DC)	20.4 V DC
• Upper limit of permissible range (DC)	28.8 V DC
• Short-circuit protection	Yes, for potential group
• Reverse polarity protection	Yes; against destruction
• Max. infeed current	8 A
Current consumption from supply voltage 1L+, typ.	335 mA
Power loss, typ.	8.5 W
Memory type	Micro Memory Card, is required

# SIMATIC ET 200 fail-safe distributed IO

## SIMATIC ET 200pro fail-safe distributed IO

### IM 154-6 PN IWLAN

IM 154-6 PN IWLAN interface module	6ES7 154-6AB00-0AB0 6ES7 154-6AB50-0AB0
Address range/address volume	
• Outputs	256 byte
• Inputs	256 byte
Reports	
• PROFINET IO	Yes
• Industrial Wireless LAN	Yes
PROFINET IO services	ARP, PING, SNMP
Industrial Wireless LAN	
• Transmission rate, max.	54 Mbit/s
• Standards for wireless communication	IEEE 802.11a IEEE 802.11b IEEE 802.11g IEEE 802.11h (not valid for 6ES7 154-6AB50-0AB0) IEEE 802.11e IEEE 802.11i
• Radio frequency for WLAN in 2.4 GHz frequency band	2,4 ... 2.4835 GHz
• Radio frequency for WLAN in 5 GHz frequency band	5,15 ... 5.825 GHz
• Transmission method	Direct Sequence Spread Spectrum (DSSS) Complementary Code Keying (CCK) Orthogonal Frequency Division Multiplexing (OFDM)
• Supported IWLAN services	Current approvals can be found in the Internet at <a href="http://support.automation.siemens.com/WW/view/com/19812553">http://support.automation.siemens.com/WW/view/com/19812553</a>
• Connection for external antenna	
Parameters	
• Diagnostic interrupt	Yes
• Maintenance alarm	Yes
• Hardware interrupt	Yes
• Swapping interrupt	Yes
• Identifier-related diagnostic data	Yes
• Module status	Yes
• Channel-specific diagnostics	Yes
• Start-up if preset configuration is not equal to actual configuration	Yes
• Module replacement during operation	Yes
Diagnostics indication (LED)	Yes
• Group fault (red)	Yes
• Bus fault (red)	Yes
• Maintenance information (yellow)	Yes
• Monitoring 24 V power supply ON (green)	Yes
• Load voltage monitoring 24 V DC (green)	Yes
• Connection to an Access Point R1 LINK (green)	Yes
• Data exchange R1 RX/TX (yellow)	Yes
• Connection to a PG/PC (green)	Yes
• Data exchange with a PG/PC (yellow)	Yes
Insulation tested at	500 V DC
Isolation	
• Between the backplane bus and supply voltage 1L+ and 2L+	Yes
• Between Ethernet and supply voltage 1L+ and 2L+	Yes
• Between the supply voltage and electronic components	Yes

IM 154-6 PN IWLAN interface module	6ES7 154-6AB00-0AB0 6ES7 154-6AB50-0AB0
Operating temperature	
• Minimum	-25 °C
• Maximum	55 °C
Storage/transport temperature	
• Minimum	-40 °C
• Maximum	70 °C
Degree of protection	IP65, IP66, IP67
General information	
• Manufacturer's code (VendorID)	0x002A
• Device ID	0x0305
Dimensions	
• Width	135 mm
• Height	130 mm
• Depth	60 mm
Weight, approx.	1085 g

### Selection and ordering data

	Order No.
<b>IM 154-6 PN HF IWLAN interface module</b>	
For communication between ET 200pro and host controllers over Industrial Wireless LAN (IWLAN) radio networks; support of PROFIsafe	
With various national approvals; refer to the current list of approvals	<b>6ES7 154-6AB00-0AB0</b>
With approval for USA	<b>6ES7 154-6AB50-0AB0</b>
<b>Antennas with omnidirectional characteristic</b>	
Mounting directly on IM154-6 PN HF IWLAN	
• ANT IM 154-6 IWLAN; 2 units	<b>6ES7 194-4MA00-0AA0</b>
For wall or pipe mounting	
• ANT 792-6MN; rod antenna N-Connect female 2.4 GHz; 1 unit	<b>6GK5 792-6MN00-0AA6</b>
• ANT793-6MN; rod antenna N-Connect female 5 GHz; 1 unit	<b>6GK5 793-6MN00-0AA6</b>
For use with the RCoax antenna system	
• ANT 792-4DN; RCoax N-Connect female 2.4 GHz; 1 unit	<b>6GK5 792-4DN00-0AA6</b>
• ANT793-4MN; RCoax N-Connect female 5 GHz; 1 unit	<b>6GK 5793-4MN00-0AA6</b>
<b>Antenna cables IWLAN RCoax; N-Connect / R-SMA</b>	
1 m long	<b>6XV1 875-5CH10</b>
2 m long	<b>6XV1 875-5CH20</b>
5 m long	<b>6XV1 875-5CH50</b>
10 m long	<b>6XV1 875-5CN10</b>
IWLAN terminating resistor 50 Ohm for second R-SMA antenna socket, 3 units	<b>6GK5 795-1TR10-0AA6</b>
<b>Accessories</b>	
<b>7/8" connecting cable to power supply</b>	
5-core, 5 x 1.5 mm <sup>2</sup> , trailing type, pre-assembled with two 7/8" connectors	
1.5 m long	<b>6XV1 822-5BH15</b>



# SIMATIC ET 200 fail-safe distributed IO

## SIMATIC ET 200pro fail-safe distributed IO

IM 154-6 PN IWLAN

	Order No.
2.0 m long	<b>6XV1 822-5BH20</b>
3.0 m long	<b>6XV1 822-5BH30</b>
5.0 m long	<b>6XV1 822-5BH50</b>
10 m long	<b>6XV1 822-5BN10</b>
15 m long	<b>6XV1 822-5BN15</b>
• Other special lengths with 90° or 180° cable outlet	See <a href="http://support.automation.siemens.com/WW/view/en/26999294">http://support.automation.siemens.com/WW/view/en/26999294</a>
<b>Power line</b>	<b>6XV1 830-8AH10</b>
5-core, 5 x 1.5 mm <sup>2</sup> , trailing type, sold by the meter, minimum order quantity 20 m, maximum order quantity 1,000 m	
<b>7/8" cable connector</b>	<b>6GK1 905-0FB00</b>
For ET 200eco, with axial cable outlet; with socket insert, pack of 5	
<b>Twisted Pair cables 4x2 with RJ45 connectors</b>	
0.5 m long	<b>6XV1 870-3QE50</b>
1 m long	<b>6XV1 870-3QH10</b>
2 m long	<b>6XV1 870-3QH20</b>
6 m long	<b>6XV1 870-3QH60</b>
10 m long	<b>6XV1 870-3QN10</b>
<b>Crossed Twisted Pair cables 4x2 with RJ45 connectors</b>	
0.5 m long	<b>6XV1 870-3RE50</b>
1 m long	<b>6XV1 870-3RH10</b>
2 m long	<b>6XV1 870-3RH20</b>
6 m long	<b>6XV1 870-3RH60</b>
10 m long	<b>6XV1 870-3RN10</b>
<b>IE FC RJ45 Plug 180</b>	
180° cable outlet; for line components and CPs/CPUs with Industrial Ethernet interface	
• 1 pack = 1 unit	<b>6GK1 901-1BB10-2AA0</b>
• 1 pack = 10 units	<b>6GK1 901-1BB10-2AB0</b>
<b>IE FC RJ45 Plug 90</b>	
90° cable outlet; e.g. for ET 200S	
• 1 pack = 1 unit	<b>6GK1 901-1BB20-2AA0</b>
• 1 pack = 10 units	<b>6GK1 901-1BB20-2AB0</b>
<b>General accessories</b>	
<b>ET 200pro rack</b>	
• Narrow, for interface, electronics and power modules	
- 500 mm	<b>6ES7 194-4GA00-0AA0</b>
- 1000 mm	<b>6ES7 194-4GA60-0AA0</b>
- 2000 mm, can be cut to length	<b>6ES7 194-4GA20-0AA0</b>
• Compact, for interface, electronics and power modules	
- 500 mm	<b>6ES7 194-4GC70-0AA0</b>
- 1000 mm	<b>6ES7 194-4GC60-0AA0</b>
- 2000 mm, can be cut to length	<b>6ES7 194-4GC20-0AA0</b>
• Wide, for interface, electronics, power modules and motor starters	
- 500 mm	<b>6ES7 194-4GB00-0AA0</b>
- 1000 mm	<b>6ES7 194-4GB60-0AA0</b>
- 2000 mm, can be cut to length	<b>6ES7 194-4GB20-0AA0</b>

	Order No.
• Wide, for I/O modules and motor starters	
- 500 mm	<b>6ES7 194-4GD00-0AA0</b>
- 1000 mm	<b>6ES7 194-4GD10-0AA0</b>
- 2000 mm	<b>6ES7 194-4GD20-0AA0</b>
<b>Spare fuse</b>	<b>6ES7 194-4HB00-0AA0</b>
12.5 A quick-response, for interface and power modules, 10 items per package unit	
<b>Labels</b>	<b>3RT1 900-1SB20</b>
20 x 7 mm, pale turquoise, 340 units per pack	
<b>SIMATIC Micro Memory Card</b>	
• 64 KB	<b>6ES7 953-8LF20-0AA0</b>
• 128 KB	<b>6ES7 953-8LG20-0AA0</b>
• 512 KB	<b>6ES7 953-8LJ20-0AA0</b>
<b>SIMATIC Manual Collection</b>	<b>6ES7 998-8XC01-8YE0</b>
Electronic manuals on DVD, multi-language: S7-200, TD 200, S7-300, M7-300, C7, S7-400, M7-400, STEP 7, Engineering Tools, Runtime Software, SIMATIC DP (Distributed I/O), SIMATIC HMI (Human Machine Interface), SIMATIC NET (Industrial Communication)	
<b>SIMATIC Manual Collection – Update service for 1 year</b>	<b>6ES7 998-8XC01-8YE2</b>
Scope of delivery: Current DVD "S7 Manual Collection" and the three subsequent updates	
∅	

### Additional information

#### Radio approvals

Current approvals are available in the Internet.

#### In Germany

<http://www.siemens.com/funkzulassungen>

#### Outside Germany:

<http://www.siemens.com/wireless-approvals>

# SIMATIC ET 200 fail-safe distributed IO

## SIMATIC ET 200pro fail-safe distributed IO

### IM 154-8 F PN/DP CPU

#### Overview



- Interface module for SIMATIC ET 200pro with integrated fail-safe CPU
- CPU with PLC functionality equivalent to CPU S7-315F PN/DP; with distributed intelligence for preprocessing
- For constructing a fail-safe automation system for plants with increased safety requirements
- Complies with safety requirements up to SIL 3 according to IEC 61508, IEC 62061, up to PLe according to ISO 13849-1:2006 and Cat. 4 according to EN 954-1
- For high-performance control solutions in ET 200pro
- Increase of the availability of systems and machines
- Integral Web server with the option of creating user-defined Web sites
- Isochronous mode on PROFIBUS or PROFINET
- PROFINET IO Controller for up to 128 IO Devices
- PROFINET interface with integrated 3-port switch
- With many communication options: PG/OP communication, PROFINET IO, PROFINET CBA, open IE communication (TCP, ISO-on-TCP and UDP), web server and S7-communication (with loadable FBs)
- Fast, simple and end-to-end programming of a system with modular programs via STEP 7
- Compact SIMATIC Micro Memory Card (MMC)

#### Note:

SIMATIC Micro Memory Card required for operation of CPU.

#### Application

The intelligent interface module IM 154-8 F PN/DP CPU features integrated PLC functionality. The functions included correspond to those of the S7-300 CPU 315F PN/DP.

The IM 154-8 F PN/DP CPU can be used simultaneously as an IO Controller and as an I-Device on PROFINET via the integral PROFINET interface.

The ET 200pro can use this interface module to control autonomous technological functional units, e.g.:

- Conveyor systems, switches
- Lifting stations
- Positioning tasks

Further distributed I/Os can be connected via the additionally available PROFIBUS interface. In doing so, the IM 154-8 F PN/DP CPU can be used as master or slave on PROFIBUS.

In this way, applications in extensive manufacturing cells are possible with preprocessing; stand-alone operation is also possible. Cabinet-free installations are possible due to the high IP67 rating.

#### Design

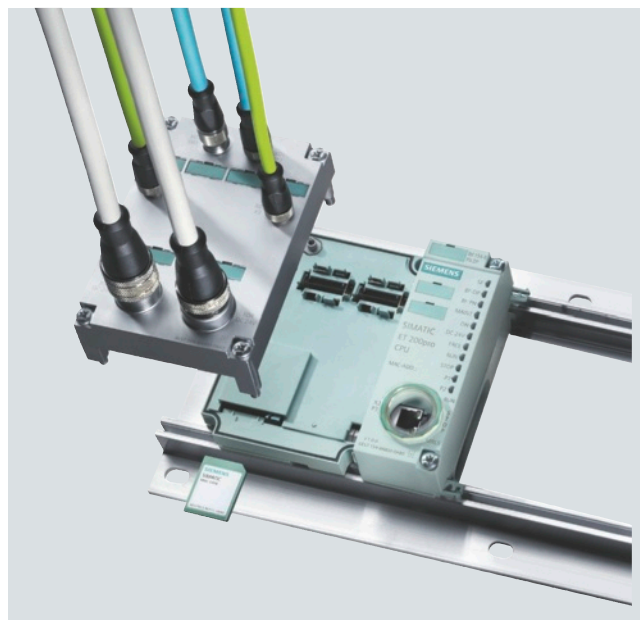

Interface module and connection module

The IM 154-8 F PN/DP CPU intelligent interface module consists of two components:

- IM 154-8 F PN/DP CPU (6ES7 154-8FB01-0AB0) and
- CM IM PN DP M12 7/8" connection module (6ES7 194-4AN00-0AA0)

Both components are sold separately.

The IM 154-8 F PN/DP CPU interface module features the following:

- 3 PROFINET ports (2 x M12, 1 x RJ45)
- 2 MPI/PROFIBUS connections (input and output, M12)
- Integral CPU with the performance power of an S7-300-CPU 315F PN/DP
- RUN/STOP switch and RJ45 PROFINET port behind a sealed cover
- Micro Memory Card below the connection module

#### Function

##### Configurable and programmable properties

- I/O setup: Type and scope
- Startup and cycle behavior: Stipulation of maximum cycle time and loading as well as self-test functions
- Definition of the number of retentive bit memories, counters, timers and data blocks
- Clock memory: Address setting
- Protection level: Specifying the access rights to programs and data
- Definition of the handling and scope of diagnostic messages
- Cyclic interrupts: Setting of periodicity
- Time-of-day interrupts: Setting of date and time of start and periodicity

# SIMATIC ET 200 fail-safe distributed IO

## SIMATIC ET 200pro fail-safe distributed IO

### IM 154-8 F PN/DP CPU

#### Display and information functions

- Status and error functions; LEDs indicate, for example, hardware, programming, time or I/O errors, as well as operating states such as RUN, STOP, restart, etc.
- Test functions; the PG is used to indicate signal statuses during program execution, to modify process variables independently of the user program and to output the contents of stack memories
- Information functions; you can use the programming device to obtain information about the storage capacity and operating mode of the CPU as well as the current utilization of the main and load memories, current cycle times and diagnostic buffer contents in plain text

#### Programming, parameterization

The ET 200pro with IM 154-8 F PN/DP CPU can be universally programmed, configured and diagnosed from any point in the network. STEP 7, V5.5 or higher, is used for this.

#### SIMATIC S7 Distributed Safety option package

The STEP 7 option package "SIMATIC S7 Distributed Safety" is required for programming the safety-related program components. The package contains all the necessary functions and blocks for creating the F program.

The F program with the safety functions is connected in F FBD or F LAD or using special function blocks from the F library. Use of F FBD or F LAD simplifies configuration and programming of the system and also acceptance testing thanks to the cross-system uniform presentation form. Programmers can concentrate fully on the safety-related application without having to use additional tools.

#### Technical specifications

Order No.	6ES7 154-8FB01-0AB0
<b>Product version</b>	
associated programming package	STEP 7 V 5.5 or higher, Distributed Safety V 5.4 SP4
<b>Supply voltages</b>	
external protection for supply cables (recommendation)	MCB 24V DC / 16A with tripping characteristic Type B and C (see ET 200pro manual)
<b>Current consumption</b>	
Current consumption (rated value)	350 mA; typical
Current consumption (in no-load operation), typ.	250 mA; typical, current consumption for CPU in STOP state
Inrush current, typ.	2 A; typical
$I^2t$	0.25 A <sup>2</sup> -s; typical
<b>Power losses</b>	
Power loss, typ.	8.5 W; typical
<b>Memory</b>	
Work memory	
• integrated	512 Kbyte
• expandable	No
Load memory	
• pluggable (MMC)	Yes
• pluggable (MMC), max.	8 Mbyte
Backup	
• present	Yes; Ensured by MMC (maintenance-free)
• without battery	Yes; Program and data
<b>CPU-blocks</b>	
DB	
• Number, max.	1 024; Number range: 1 to 16,000
• Size, max.	64 Kbyte

Order No.	6ES7 154-8FB01-0AB0
FB	
• Number, max.	1 024; Number range: 0 to 7,999
• Size, max.	64 Kbyte
FC	
• Number, max.	1 024; Number range: 0 to 7,999
• Size, max.	64 Kbyte
OB	
• Size, max.	64 Kbyte
Nesting depth	
• per priority class	16
• additional within an error OB	4
<b>CPU processing times</b>	
for bit operations, min.	0.05 µs
for word operations, min.	0.09 µs
for fixed point arithmetic, min.	0.12 µs
for floating point arithmetic, min.	0.45 µs
<b>Counters, timers and their retentivity</b>	
S7 counter	
• Number	256
• Retentivity	
- can be set	Yes
- lower limit	0
- upper limit	255
• Counting range	
- can be set	Yes
- lower limit	0
- upper limit	999
IEC counter	
• present	Yes
• Type	SFB
S7 times	
• Number	256
• Retentivity	
- can be set	Yes
- lower limit	0
- upper limit	255
- preset	No retentivity
• Time range	
- lower limit	10 ms
- upper limit	9 990 s
IEC timer	
• present	Yes
• Type	SFB
• Number	Unlimited (limited only by RAM capacity)
<b>Data areas and their retentivity</b>	
Flag	
• Number, max.	2 048 byte
• Retentivity available	Yes; MB 0 to MB 2047
• Number of clock memories	8
Data blocks	
• Number, max.	1 024; Number range: 1 to 16,000
• Size, max.	64 Kbyte
• Retentivity adjustable	Yes; via non-retain property on DB yes
• Retentivity preset	
Local data	
• per priority class, max.	32 768 byte; 2048 bytes max. per block

# SIMATIC ET 200 fail-safe distributed IO

## SIMATIC ET 200pro fail-safe distributed IO

### IM 154-8 F PN/DP CPU

Order No.	6ES7 154-8FB01-0AB0
<b>Address area</b>	
I/O address area	
• overall	2 048 byte
• Outputs	2 048 byte
• of which, distributed	
- Inputs	2 048 byte
- Outputs	2 048 byte
<b>Process image</b>	
• Inputs, adjustable	2 048 byte
• Outputs, adjustable	2 048 byte
• Inputs, default	128 byte
• Outputs, default	128 byte
<b>Subprocess images</b>	
• Number of subprocess images, max.	1; With PROFINET IO, the length of the user data is limited to 1600 bytes
<b>Digital channels</b>	
• Inputs	16 384
• Outputs	16 384
• Inputs, of which central	128
• Outputs, of which central	64
<b>Analog channels</b>	
• Inputs	1 024
• Outputs	1 024
• Inputs, of which central	64
• Outputs, of which central	64
<b>Hardware configuration</b>	
Racks, max.	1
Modules per rack, max.	16; Expansion width max. 1m
Number of DP masters	
• integrated	1
<b>Time of day</b>	
Clock	
• Hardware clock (real-time clock)	Yes
• battery-backed and synchronizable	Yes
• Deviation per day, max.	10 s; typ.: 2 s
Runtime meter	
• Number	1
• Number/Number range	0
• Range of values	0 to 2 <sup>31</sup> hours (when using SFC 101)
• Granularity	1 h
• retentive	Yes; must be restarted at each restart
Clock synchronization	
• supported	Yes
• to MPI, master	Yes
• to MPI, slave	Yes
• to DP, master	Yes; With DP slave only slave clock
• to DP, slave	Yes
• on Ethernet via NTP	Yes; as client
<b>S7 message functions</b>	
Number of login stations for message functions, max.	16; Depending on the connections configured for PG/OP and S7 basic communication
Process diagnostic messages	
simultaneously active Alarm-S blocks, max.	300
<b>Test commissioning functions</b>	
Status/control	
• Status/control variable	Yes
• Variables	Inputs, outputs, memory bits, DB, times, counters

Order No.	6ES7 154-8FB01-0AB0
• Number of variables, max.	30
• of which status variables, max.	30
• of which control variables, max.	14
<b>Forcing</b>	
• Forcing	Yes
<b>Status block</b>	
Single step	Yes
<b>Number of breakpoints</b>	
Diagnostic buffer	4
• present	Yes
• Number of entries, max.	500; Only the last 100 entries are retentive at power on/off
- can be set	No
- preset	10
<b>Monitoring functions</b>	
Status LEDs	Yes
<b>Communication functions</b>	
PG/OP communication	Yes
<b>Routing</b>	
Global data communication	Yes
• supported	Yes
• Size of GD packets, max.	22 byte
<b>S7 basic communication</b>	
• supported	Yes
<b>S7 communication</b>	
• supported	Yes
<b>Web server</b>	
• supported	Yes
• Number of HTTP clients	5
• User-defined websites	Yes
<b>Open IE communication</b>	
• TCP/IP	Yes; Via integrated PROFINET interface and loadable FBs
- Number of connections, max.	8
- Data length, max.	32 768 byte; 1460 bytes with connection type 01H; 32768 bytes with connection type 11H
- Several passive connections per port, supported	Yes
• ISO-on-TCP (RFC1006)	Yes
- Number of connections, max.	8
- Data length, max.	32 768 byte
• UDP	Yes
- Number of connections, max.	8
- Data length, max.	1 472 byte
<b>Number of connections</b>	
• overall	16
• usable for PG communication	15
• usable for OP communication	15
• usable for S7 basic communication	14
• usable for routing	X1 as MPI: max. 10; X1 as DP master: max. 24; X1 as DP slave (active): max. 14; X2 as PROFINET: 24 max.
<b>PROFINET CBA (at set setpoint communication load)</b>	
• Setpoint for the CPU communication load	50 %
• Number of remote interconnection partners	32
• Number of functions, master/slave	30
• Total of all Master/Slave connections	1 000

# SIMATIC ET 200 fail-safe distributed IO

## SIMATIC ET 200pro fail-safe distributed IO

### IM 154-8 F PN/DP CPU

Order No.	6ES7 154-8FB01-0AB0
• Data length of all incoming connections master/slave, max.	4 000 byte
• Data length of all outgoing connections master/slave, max.	4 000 byte
• Number of device-internal and PROFIBUS interconnections	500
• Data length of device-internal und PROFIBUS interconnections, max.	4 000 byte
• Data length per connection, max.	1 400 byte
• Remote interconnections with acyclic transmission	
- Sampling frequency: Sampling time, min.	500 ms
- Number of incoming interconnections	100
- Number of outgoing interconnections	100
- Data length of all incoming interconnections, max.	2 000 byte
- Data length of all outgoing interconnections, max.	2 000 byte
- Data length per connection, max.	1 400 byte
• Remote interconnections with cyclic transmission	
- Transmission frequency: Transmission interval, min.	1 ms
- Number of incoming interconnections	200
- Number of outgoing interconnections	200
- Data length of all incoming interconnections, max.	2 000 byte
- Data length of all outgoing interconnections, max.	2 000 byte
- Data length per connection, max.	450 byte
• HMI variables via PROFINET (acyclic)	
- Number of stations that can log on for HMI variables (PN OPC/iMap)	3; 2x PN OPC/1x iMap
- HMI variable updating	500 ms
- Number of HMI variables	200
- Data length of all HMI variables, max.	2 000 byte
• PROFIBUS proxy functionality	
- supported	Yes
- Number of linked PROFIBUS devices	16
- Data length per connection, max.	240 byte; slave-dependent
<b>1st interface</b>	
Type of interface	Integrated RS 485 interface
Physics	RS 485/connection: 2 x M12 b-coded
Isolated	Yes
Power supply to interface (15 to 30 V DC), max.	May only be used for external terminating resistor
Functionality	
• MPI	Yes
• DP master	Yes
• DP slave	Yes
• Point-to-point connection	No
MPI	
• Services	
- PG/OP communication	Yes
- Routing	Yes
- Global data communication	Yes
- S7 basic communication	Yes
- S7 communication	Yes

Order No.	6ES7 154-8FB01-0AB0
- S7 communication, as client	No
- S7 communication, as server	Yes
• Transmission rate, max.	12 Mbit/s
DP master	
• Services	
- PG/OP communication	Yes
- Routing	Yes
- Global data communication	No
- S7 basic communication	Yes; I blocks only
- S7 communication	Yes
- S7 communication, as client	No
- S7 communication, as server	Yes; connection configured on one side only
- Equidistance mode support	Yes
- Isochronous mode	Yes; OB 61 - isochronous mode is possible either on DP or PROFINET IO (not simultaneously)
- SYNC/FREEZE	Yes
- Activation/deactivation of DP slaves	Yes
- Direct data exchange (slave-to-slave communication)	Yes; As subscriber
- DPV1	Yes
• Transmission rate, max.	12 Mbit/s
• Number of DP slaves, max.	124
• Address area	
- Inputs, max.	2 048 byte
- Outputs, max.	2 048 byte
• User data per DP slave	
- Inputs, max.	244 byte
- Outputs, max.	244 byte
DP slave	
• Services	
- Routing	Yes; With active interface
- Global data communication	No
- S7 basic communication	No
- S7 communication	Yes
- S7 communication, as client	No
- S7 communication, as server	Yes; connection configured on one side only
- Direct data exchange (slave-to-slave communication)	Yes
- DPV1	No
• Transmission rate, max.	12 Mbit/s
• Transfer memory	
- Inputs	244 byte
- Outputs	244 byte
• Address area, max.	32
• User data per address area, max.	32 byte
<b>2nd interface</b>	
Type of interface	PROFINET
Physics	Ethernet (2 x M12 d-coded; 1 x RJ45)
Isolated	Yes; Galvanic isolation for P3 is implemented in IM154-8, for P1 and P2 in CM
Integrated switch	Yes
Number of ports	3
automatic detection of transmission speed	Yes; 10/100 Mbit/s
Autonegotiation	Yes
Autocrossing	Yes
Media redundancy	
• supported	Yes
• Switchover time on line break, typically	200 ms; PROFINET MRP

# SIMATIC ET 200 fail-safe distributed IO

## SIMATIC ET 200pro fail-safe distributed IO

### IM 154-8 F PN/DP CPU

Order No.	6ES7 154-8FB01-0AB0
• Number of stations in the ring, max.	50
Change of IP address at runtime, supported	Yes
Functionality	
• MPI	No
• DP master	No
• DP slave	No
• PROFINET IO Controller	Yes; also simultaneously with IO Device functionality
• PROFINET IO Device	Yes; Also simultaneously with IO Controller functionality
• PROFINET CBA	Yes
• Open IE communication	Yes; Via TCP/IP, ISO on TCP, UDP
• Web server	Yes
PROFINET IO Controller	
• Services	
- PG/OP communication	Yes
- Routing	Yes
- S7 communication	Yes; With loadable FBs, max. configurable connections: 14, max. number of instances: 32
- Isochronous mode	Yes; OB 61 - isochronous mode is possible either on DP or PROFINET IO (not simultaneously)
- Open IE communication	Yes; Via TCP/IP, ISO on TCP, UDP
• Transmission rate, max.	100 Mbit/s
• Number of connectable IO devices, max.	128
• Max. number of connectable IO devices for RT	128
- of which in line, max.	128
• Number of IO Devices with IRT and the option "high flexibility"	128
- of which in line, max.	61
• Number of IO Devices with IRT and the option "high performance", max.	64
- of which in line, max.	64
• IRT, supported	Yes
• Prioritized startup supported	Yes
- Number of IO Devices, max.	32
• Activation/deactivation of IO Devices	Yes
- Number of IO Devices that can be simultaneously activated/deactivated, max.	8
• IO Devices changing during operation (partner ports), supported	Yes
- Max. number of IO devices per tool	8
• Device replacement without swap medium	Yes
• Send clock times	250 µs, 500 µs, 1 ms; 2 ms, 4 ms (not in the case of IRT with "high flexibility" option)
• Updating time	250 µs to 512 ms (depending on the operating mode, see "IM 154-8 CPU Interface Module" operating instructions for more details)
• Address area	
- Inputs, max.	2 048 byte
- Outputs, max.	2 048 byte
• User data per address area, max.	
- User data consistency, max.	1 024 byte
PROFINET IO device	
• Services	
- PG/OP communication	Yes
- Routing	Yes

Order No.	6ES7 154-8FB01-0AB0
- S7 routing	Yes
- S7 communication	Yes; With loadable FBs, max. configurable connections: 14, max. number of instances: 32
- Isochronous mode	No
- Open IE communication	Yes; Via TCP/IP, ISO on TCP, UDP
- IRT, supported	Yes
- PROFlenergy, supported	Yes; With SFB 73 / 74 prepared for loadable PROFlenergy standard FB for I-Device
- Shared device, supported	Yes
- Number of IO controllers with shared device, max.	2
• Transfer memory	
- Inputs, max.	1 440 byte; per IO Controller with shared device
- Outputs, max.	1 440 byte; per IO Controller with shared device
• Submodules	
- Number, max.	64
- User data per submodule, max.	1 024 byte
PROFINET CBA	
• acyclic transmission	Yes
• cyclic transmission	Yes
Open IE communication	
• Open IE communication, supported	Yes
• Number of connections, max.	8
• Local port numbers used at the system end	0, 20, 21, 23, 25, 80, 102, 135, 161, 8080, 34962, 34963, 34964, 65532, 65533, 65534, 65535
• Keep-alive function, supported	Yes
<b>Isochronous mode</b>	
Isochronous mode	Yes; Via PROFIBUS DP or PROFINET interface
<b>programming</b>	
Programming language	
• STEP 7	Yes; V5.5 or higher
• LAD	Yes
• FBD	Yes
• STL	Yes
• SCL	Yes
• CFC	Yes
• GRAPH	Yes
• HiGraph®	Yes
Command set	see instruction list
Nesting levels	8
Know-how protection	
• User program protection/password protection	Yes
• Block encryption	Yes; With S7 block Privacy
System functions (SFC)	See instruction list
System function blocks (SFB)	See instruction list
<b>Galvanic isolation</b>	
between backplane bus and electronics	No
between backplane bus and all other circuit components	Yes
between supply and all other circuits	Yes

# SIMATIC ET 200 fail-safe distributed IO

## SIMATIC ET 200pro fail-safe distributed IO

IM 154-8 F PN/DP CPU

<b>Order No.</b>	<b>6ES7 154-8FB01-0AB0</b>
<b>Standards, approvals, certificates</b>	
CE mark	Yes
CSA approval	No
C-TICK	Yes
cULus	Yes
FM approval	No
<b>Dimensions and weight</b>	
Dimensions	
• Width	135 mm
• Height	130 mm
• Depth	65 mm; 60 mm without cover for RJ45 socket; 65 mm with cover for RJ45 socket
Weight	
• Weight, approx.	720 g

# SIMATIC ET 200 fail-safe distributed IO

## SIMATIC ET 200pro fail-safe distributed IO

### IM 154-8 F PN/DP CPU

#### Selection and ordering data

	Order No.		Order No.
<b>IM 154-8 F PN/DP CPU interface module, V3.2</b> Fail-safe PROFINET IO Controller to operate distributed I/Os on PROFINET, with integrated PLC functionality	<b>6ES7 154-8FB01-0AB0</b>	<b>Industrial Ethernet FC RJ45 Plug 180</b> RJ45 plug connector for Industrial Ethernet with a rugged metal enclosure and integrated insulation displacement contacts for connecting Industrial Ethernet FC installation cables; with 180° cable outlet 1 unit 10 units 50 units	<b>6GK1 901-1BB10-2AA0</b> <b>6GK1 901-1BB10-2AB0</b> <b>6GK1 901-1BB10-2AE0</b>
<b>Distributed Safety V5.4 programming tool</b> Task: Software for configuring fail-safe application programs for SIMATIC S7-300F, S7-400F, ET 200S Requirement: STEP 7 V5.3 SP3 and higher Floating license		<b>Industrial Ethernet Fast Connect installation cables</b> <ul style="list-style-type: none"> <li>Fast Connect standard cable</li> <li>Fast Connect trailing cable</li> <li>Fast Connect marine cable</li> </ul>	<b>6XV1 840-2AH10</b> <b>6XV1 840-3AH10</b> <b>6XV1 840-4AH10</b>
<b>Distributed Safety Upgrade</b> From V5.3 to V5.4; Floating license for 1 user	<b>6ES7 833-1FC02-0YA5</b> <b>6ES7 833-1FC00-0YX2</b> <b>6ES7 833-1FC02-0YE5</b>	<b>Industrial Ethernet FastConnect installation cables</b> <ul style="list-style-type: none"> <li><b>IE FC TP Trailing Cable GP 2 x 2;</b>                Sold by the meter, max. order quantity 1000 m;                Minimum order quantity 20 m</li> <li><b>IE TP Torsion Cable GP 2 x 2;</b>                Sold by the meter, max. order quantity 1000 m;                Minimum order quantity 20 m</li> </ul>	<b>6XV1 870-2D</b> <b>6XV1 870-2F</b>
<b>Accessories</b> <b>MMC 64 KB <sup>1)</sup></b> for program backup	<b>6ES7 953-8LF20-0AA0</b>	<b>Industrial Ethernet Fast Connect</b> Stripping Tool	<b>6GK1 901-1GA00</b>
<b>MMC 128 KB <sup>1)</sup></b> for program backup	<b>6ES7 953-8LG20-0AA0</b>	<b>IE Connecting Cable M12-180/M12-180</b> Preassembled IE FC TP Trailing Cable GP 2 x 2 (PROFINET Type C) with two 4-pin M12 plugs (4-pin, D-coded), degree of protection IP65/IP67, length:	
<b>MMC 512 KB <sup>1)</sup></b> for program backup	<b>6ES7 953-8LJ20-0AA0</b>	0.3 m	<b>6XV1 870-8AE30</b>
<b>MMC 2 MB <sup>1)</sup></b> for program backup and/or firmware updates	<b>6ES7 953-8LL20-0AA0</b>	0.5 m	<b>6XV1 870-8AE50</b>
<b>MMC 4 MB <sup>1)</sup></b> for program backup	<b>6ES7 953-8LM20-0AA0</b>	1.0 m	<b>6XV1 870-8AH10</b>
<b>MMC 8 MB <sup>1)</sup></b> for program backup	<b>6ES7 953-8LP20-0AA0</b>	1.5 m	<b>6XV1 870-8AH15</b>
<b>Connection module</b> For CPU IM154-8 PN/DP, with 4 x M12 and 2 x 7/8", to connect PROFINET and PROFIBUS DP	<b>6ES7 194-4AN00-0AA0</b>	2.0 m	<b>6XV1 870-8AH20</b>
<b>SCALANCE X-200 Industrial Ethernet Switches</b> With integral SNMP access, Web diagnostics, copper cable diagnostics and PROFINET diagnostics, for setting up linear, star and ring structures SCALANCE X208PRO, in degree of protection IP65, with eight 10/100 Mbit/s M12 ports, incl. eleven M12 dust caps	<b>6GK5 208-0HA00-2AA6</b>	3.0 m	<b>6XV1 870-8AH30</b>
<b>Industrial Ethernet FC RJ45 Plug 90</b> RJ45 plug connector for Industrial Ethernet with a rugged metal enclosure and integrated insulation displacement contacts for connecting Industrial Ethernet FC installation cables; with 90° cable outlet 1 unit 10 units	<b>6GK1 901-1BB20-2AA0</b> <b>6GK1 901-1BB20-2AB0</b>	5.0 m	<b>6XV1 870-8AH50</b>
		10 m	<b>6XV1 870-8AN10</b>
		15 m	<b>6XV1 870-8AN15</b>
		PROFINET M12 connecting cable, trailing cable preassembled at both ends with angled M12 connectors (male insert)	
		3.0 m	<b>3RK1 902-2NB30</b>
		5.0 m	<b>3RK1 902-2NB50</b>
		10 m	<b>3RK1 902-2NC10</b>
		PROFINET M12 connecting cable, trailing cable preassembled at one end with angled M12 connector (male insert at one end, other end unconnected)	
		3.0 m	<b>3RK1 902-2HB30</b>
		5.0 m	<b>3RK1 902-2HB50</b>
		10 m	<b>3RK1 902-2HC10</b>



# SIMATIC ET 200 fail-safe distributed IO

## SIMATIC ET 200pro fail-safe distributed IO

IM 154-8 F PN/DP CPU

	Order No.
<b>IE FC M12 Plug PRO</b> PROFINET M12 plug connector, D-coded with fast connection system, axial cable outlet 1 unit 8 units PROFINET M12 plug connector, D-coded, angled	<b>6GK1 901-0DB20-6AA0</b> <b>6GK1 901-0DB20-6AA8</b> <b>3RK1 902-2DA00</b>
<b>IE panel feedthrough</b> Cabinet feedthrough for converting from the M12 connection system (D-coded, IP65/IP67) to the RJ45 connection system (IP20), 1 pack = 5 units	<b>6GK1 901-0DM20-2AA5</b>
<b>7/8" connecting cable to power supply</b> 5-core, 5 x 1.5 mm <sup>2</sup> , trailing type, preassembled with two 7/8" connectors (axial cable outlet), 5-pin, up to 50 m • 1.5 m long • 2.0 m long • 3.0 m long • 5.0 m long • 10 m long • 15 m long • Other special lengths with 90° or 180° cable outlet  power cable, can be trailed, 5 x 1.5 mm <sup>2</sup> , preassembled at both ends with 7/8" angled connectors (female insert at one end, male insert at the other end) • 3.0 m long • 5.0 m long • 10 m long • Power cable, can be trailed, 5 x 1.5 mm <sup>2</sup> , preassembled at one end with 7/8" angled connector with female insert (female insert at one end, other end unconnected) • 3.0 m long • 5.0 m long • 10 m long	<b>6XV1 822-5BH15</b> <b>6XV1 822-5BH20</b> <b>6XV1 822-5BH30</b> <b>6XV1 822-5BH50</b> <b>6XV1 822-5BN10</b> <b>6XV1 822-5BN15</b> See <a href="http://support.automation.siemens.com/WWW/view/en/26999294">http://support.automation.siemens.com/WWW/view/en/26999294</a>  <b>3RK1 902-3NB30</b> <b>3RK1 902-3NB50</b> <b>3RK1 902-3NC10</b>  <b>3RK1 902-3GB30</b> <b>3RK1 902-3GB50</b> <b>3RK1 902-3GC10</b>
<b>Power line</b>	<b>6XV1 830-8AH10</b>
5-core, 5 x 1.5 mm <sup>2</sup> , trailing type, sold by the meter, minimum order quantity 20 m, maximum order quantity 1,000 m	
<b>7/8" cable connector</b> For ET 200eco, with axial cable outlet • with male insert, 5 per pack • with female insert, 5 per pack • angled, with female insert, 1 unit • angled, with male insert, 1 unit 7/8" cover cap, 10 per pack	<b>6GK1 905-0FA00</b> <b>6GK1 905-0FB00</b> <b>3RK1 902-3DA00</b> <b>3RK1 902-3BA00</b> <b>6ES7 194-3JA00-0AA0</b>
<b>Twisted Pair cables 4x2 with RJ45 connectors</b> 0.5 m long 1 m long 2 m long 6 m long 10 m long	<b>6XV1 870-3QE50</b> <b>6XV1 870-3QH10</b> <b>6XV1 870-3QH20</b> <b>6XV1 870-3QH60</b> <b>6XV1 870-3QN10</b>

	Order No.
<b>Crossed Twisted Pair cables 4x2 with RJ45 connectors</b> 0.5 m 1 m 2 m 6 m 10 m	<b>6XV1 870-3RE50</b> <b>6XV1 870-3RH10</b> <b>6XV1 870-3RH20</b> <b>6XV1 870-3RH60</b> <b>6XV1 870-3RN10</b>
<b>M12 sealing cap</b> For protection of unused M12 connections with ET 200pro	<b>3RX9 802-0AA00</b>
<b>M12 sealing caps with female thread</b> 5 units	<b>6ES7 194-4JD60-0AA0</b>
<b>PROFIBUS M12 connecting cable</b> Preassembled, with two 5-pole M12 connectors/sockets, up to 100 m; length: 1.5 m 2.0 m 3.0 m 5.0 m 10 m 15 m  Other special lengths with 90° or 180° cable outlet  M12 bus termination connector for PROFIBUS, female insert  M12 bus termination connector for PROFIBUS, male insert  M12 plug connector, axial outlet, with male insert	<b>6XV1 830-3DH15</b> <b>6XV1 830-3DH20</b> <b>6XV1 830-3DH30</b> <b>6XV1 830-3DH50</b> <b>6XV1 830-3DN10</b> <b>6XV1 830-3DN15</b>  See <a href="http://support.automation.siemens.com/WWW/view/en/26999294">http://support.automation.siemens.com/WWW/view/en/26999294</a>  <b>6GK1 905-0ED00</b> <b>6GK1 905-0EC00</b> <b>6GK1 905-0EA00</b>
<b>PROFIBUS FC Standard Cable GP</b> Standard type specially designed for fast assembly, 2-core, shielded,  Sold by the meter; Max. delivery unit 1000 m, Minimum order quantity 20 m	<b>6XV1 830-0EH10</b>
<b>PROFIBUS FC Trailing Cable</b> 2-core, shielded	<b>6XV1 830-3EH10</b>
<b>PROFIBUS FC Food Cable</b> 2-core, shielded  Sold by the meter; Max. delivery unit 1000 m, Minimum order quantity 20 m	<b>6XV1 830-0GH10</b>
<b>PROFIBUS FC Robust Cable</b> 2-core, shielded  Sold by the meter; Max. delivery unit 1000 m, Minimum order quantity 20 m	<b>6XV1 830-0JH10</b>
<b>PROFIBUS M12 cable connector</b> 5-pole, B-coded, metal casing, 1 pack = 5 units • Female insert	<b>6GK1 905-0EB00</b>

1) An MMC is essential for operating the CPU

# SIMATIC ET 200 fail-safe distributed IO

## SIMATIC ET 200pro fail-safe distributed IO

### Fail-safe digital expansion modules

#### Overview



Fail-safe digital inputs/outputs with degree of protection IP65/66/67 for application on the machine level without control cabinet

#### Fail-safe digital inputs

- For fail-safe reading of sensor information (1 or 2 channels)
- Provide integral discrepancy evaluation for 2-out-of-2 signals
- Internal sensor supplies (incl. test function) available

#### Fail-safe digital outputs

- Fail-safe 2-channel activation (sink/source output) by actuators
- Actuators can be driven by up to 2 A

All modules are certified up to Cat. 4 (EN954-1) and up to SIL 3 (IEC 61508) and feature detailed diagnostics.

The modules support PROFIsafe, both in PROFIBUS, and in PROFINET configurations. They can be used with IM 151-7 F-CPU, CPU31xF-2 DP, CPU31xF-2 PN/DP and CPU416F-2.

#### Application

The fail-safe modules of ET200pro can be used to implement the safety-related application requirements as an integral part of the overall automation. The safety functions required for fail-safe operation are integrated in the modules. The modules can be used for safety circuits up to Cat. 4/ SIL 3.

Communication to fail-safe SIMATIC S7 CPUs is performed by means of PROFIsafe.

The modules can be operated in a distributed configuration down-circuit of the IM 154-2 High Feature and IM154-4 PROFINET High Feature interface modules.

A standard power module is required to supply the modules.

#### Technical specifications

Order No.	6ES7 148-4FA00-0AB0	6ES7 148-4FC00-0AB0
<b>Supply voltages</b>		
Rated value		
• permissible range, lower limit (DC)	20.4 V	20.4 V
• permissible range, upper limit (DC)	28.8 V	28.8 V
<b>Digital inputs</b>		
Number of digital inputs	16	8
<b>Dimensions and weight</b>		
Dimensions		
• Width	90 mm	90 mm
• Height	130 mm	130 mm
• Depth	65 mm	65 mm

#### Selection and ordering data

	Order No.
<b>Fail-safe digital input module 8/16 F-DI PROFIsafe</b> 24 V DC, including bus module Connection module must be ordered separately	<b>6ES7 148-4FA00-0AB0</b>
<b>Fail-safe digital input/output module 4/8 F-DI, 4 F-DO 2 A</b> 24 V DC, including bus module Connection module must be ordered separately	<b>6ES7 148-4FC00-0AB0</b>
<b>Fail-safe electronic module F-Switch PROFIsafe</b> Three fail-safe PP-switching outputs for safe switching of the rear panel busbar (2L+, F0, F1); two fail-safe digital inputs, 45 mm; usable up to cat. 4 (EN 954)/SIL3 (IEC 61508)	<b>6ES7 148-4FS00-0AB0</b>
<b>Accessories</b>	
<b>Connection module</b> For the fail-safe electronic module F-switch PROFIsafe	<b>6ES7 194-4DA00-0AA0</b>
<b>Connection module</b> For the fail-safe electronic module 4/8 F-DI/4 F DO, 24 V DC/2 A	<b>6ES7 194-4DC00-0AA0</b>

	Order No.
<b>Connection module</b> For the fail-safe electronic module 8/16 F-DI, 24 V DC/2 A	<b>6ES7 194-4DD00-0AA0</b>
<b>PROFIBUS DP interface module IM154-2</b> Including termination module	<b>6ES7 154-2AA01-0AB0</b>
<b>PROFINET interface module IM154-4 PN</b> Including termination module	<b>6ES7 154-4AB10-0AB0</b>
<b>M12 sealing cap</b> For protection of unused M12 connections with ET 200pro	<b>3RX9 802-0AA00</b>

# SIMATIC ET 200 fail-safe distributed IO

## SIMATIC ET 200M fail-safe distributed IO

ET 200M

### Application



- Modular I/O system with degree of protection IP20, particularly suitable for user-specific and complex automation tasks
- **Fail-safe digital in/outputs as well as analog inputs for safety-oriented signal processing in accordance with PROFIsafe**
- Can be expanded with S7-300 automation system signal, communication and function modules
- Applicable Ex analog input or output modules with HART optimize the ET 200M for use in process engineering
- Can be used in redundant systems (S7-400H, S7-400F/FH)
- Consists of a PROFIBUS DP IM 153 connection, up to eight or twelve I/O modules of the S7-300 automation system (assembly with bus connections or active bus modules) and if required a power supply
- Modules can be replaced during operation (hot swapping) with the bus modules active
- Can be supplied with integrated fiber optic interface if required
- Transmission rates up to 12 Mbit/s
- Ex approval to Cat. 3 for Zone 2 acc. to ATEX100 a
- Support of modules with expanded user data, e.g. HART modules with HART minor variables

### Design

The ET 200M modular I/O station comprises:

- One IM 153 interface
- Up to 12 I/O modules of the S7-300 automation system and
- If required, one power supply.

There are no slot rules for the I/O modules. Any combination is permissible.

ET 200M is connected with PROFIBUS DP through an IM 153 interface. A fiber-optic connection to PROFIBUS DP is possible via integral interfaces on the IM 153-2 FO, via an additional OLM (Optical Link Module) or via an optical bus terminal (OBT).

Depending on the quantity structure of the master module, different types of I/O modules can be inserted.

The full address space of the ET 200M can only be used with a suitable master.

IM 153-2 FO (High Feature)	
<b>S7 master module</b>	
Function	<ul style="list-style-type: none"> <li>• PROFIBUS DP standard slave with full S7 functionality for FM/CP</li> <li>• Redundancy through 2 x IM 153-2</li> <li>• Time stamp function and time-of-day synchronization</li> <li>• Routing of parameter settings to intelligent field devices</li> <li>• Isochronous mode</li> <li>• Configuration changes in RUN in the non-redundant system</li> <li>• Identification functions</li> <li>• Firmware update via bus / Micro Memory Card</li> </ul>
Modules that can be used	SM/FM/CP
Function	PROFIBUS DP standard slave, DP V1 slave
Modules that can be used	All digital and analog S7-300 signal modules

### Configuration using bus connectors

Easy assembly using SIMATIC S7-300 bus connectors makes ET 200M flexible and service-friendly:

- Module assembly; simply locate the modules on the mounting rail, pivot them and screw them down.
- Integral backplane bus; the backplane bus is integrated into the modules. The modules are connected through bus connectors that are plugged into the back of the housings.

### Assembly using active bus modules

The active bus modules allow modules to be swapped during operation:

- Time-saving module replacement; operation is not interrupted on module replacement, it continues with the remaining modules. When the new module is inserted, it is automatically brought into operation again. When an S7-400 is used as a master, swapping of a distributed module is handled in the same manner as swapping of a central module. The relevant interrupt is generated in the CPU. For all other DP standard masters, a signal is sent to the master via DP diagnostics. With an S7-300 as master, hot swapping of modules is not supported.

Various modules are available for assembling the ET 200M that are mounted on a special mounting rail.

- BM PS/IM bus module to hold the power supply and IM 153
- BM IM 153/IM 153 bus module to hold two IM 153-2 (FO) for redundant operation
- BM 2x40 bus module to hold 2 I/O modules of 40 mm in width
- BM 1x80 bus module to hold 1 I/O module of 80 mm in width

To achieve the specified thread length, an explosion-proof partition is available as spare part; it can be inserted between two bus modules.

- Easy assembly; the bus modules are pivoted in the mounting rail, arranged end-to-end and fixed using side connectors. The modules can then be inserted in the bus modules and screwed down so that they contact the bus module connector. Connectors of unused slots must be protected with backplane bus covers. A bus module cover must be plugged into the side of the last bus module.

### Power supply

For ET 200M, single-phase power supplies are available with 2 A, 5 A and 10 A as special variants.

# SIMATIC ET 200 fail-safe distributed IO

## SIMATIC ET 200M fail-safe distributed IO

### ET 200M

#### Function

##### Operating mode

The inputs and outputs of the modular ET 200M I/O station can be accessed from the user program in the PLC in the same manner as the inputs and outputs of the central controller.

Communication through the bus system is handled completely by the master interface module in the central controller and the IM 153 interface module.

Proper operation of the ET 200M is verified by way of diagnostic functions.

The ET 200M diagnoses:

- Module faults
- Short circuits (outputs)
- Bus errors, i.e. faulty data transfer
- 24 V DC load voltage supply
- Plugging and removal of I/O modules

The diagnostic data are analyzed as follows:

- Remotely through diagnostic LEDs on the ET 200M
- Centrally via the CPU in the programmable controller

##### Configuration and parameterization

	Configuration message frame	Parameter assignment frame
Length	15 byte + 5 byte per S7-300 I/O module	10 byte + 20 byte per parameterizable S7-300 I/O module

Calculating the frame length required for the configuration and parameter assignment frame

The DP master must provide the required quantity of configuration and parameterization data. A few masters have a restricted configuration and parameterization frame length. On the S5-95U/DP, for example, the maximum length of the configuration and parameterization frame is 32 byte. This means that in this example up to 3 modules, one of which may be parameterizable, can be plugged into the ET 200M.

When the station is connected to master modules which are not parameterized with COM PROFIBUS or STEP 7 (operation on third-party master modules), a fixed preassigned GSD file can be created with COM PROFIBUS from Version 3. This file is then loaded into the configuration tool of the third-party manufacturer and can be used for simple parameter assignment of the station.

This allows the use of the user-friendly plain-text parameterization feature of COM PROFIBUS; there is no need for hexadecimal code inputs in the third-party configuring tool.

To be able to use the entire address area of the IM 153, a suitable master is required.

#### Technical specifications

##### General technical data ET 200M

Cables and connections	Screw connection, spring-loaded connection and FastConnect with permanent wiring
Degree of protection	IP20
Ambient temperature on vertical wall (preferred mounting position)	<ul style="list-style-type: none"> <li>• with horizontal assembly 0 ... +60 °C</li> <li>• with other assembly 0 ... +40 °C</li> </ul>
Relative humidity	5 ... 95% (RH stress level 2 according to IEC 1131-2)
Atmospheric pressure	795 ... 1080 hPa
Mechanical stress	<ul style="list-style-type: none"> <li>• Vibrations IEC 68, parts 2 - 6: 10 ... 57 Hz (constant amplitude 0.075 mm) 57 ... 150 Hz (constant acceleration 1 g)</li> <li>• Shock IEC 68, parts 2 - 27 half-sine, 15 g, 11 ms</li> </ul>

#### Additional Information

##### Brochures

You can download information material in the Internet:

<http://www.siemens.com/simatic/printmaterial>

### Overview

The fail-safe CPUs of SIMATIC S7 and the fail-safe signal modules of SIMATIC ET 200S, ET 200pro, ET 200eco and ET 200M have been specially developed for distributed safety-related applications in production engineering. Thanks to the discreetly modular structure of the fail-safe I/OS, safety technology is only applied where actually required. The new system replaces conventional electromechanical components, such as:

- Freely programmable, safe linking of sensors to actuators
- Selective safe shutdown of actuators
- Mixed configuration of fail-safe modules and standard modules in a station
- Single-bus concept; fail-safe signals and standard signals are transferred over a single bus medium (PROFIBUS DP, PROFINET)

#### *Totally Integrated Automation (TIA)*

Safety technology (Safety Integrated) is a component of Totally Integrated Automation which provides total integration of safety automation and standard automation (SIMATIC S7).

Where standard automation (classical PLC) and safety automation (electro-mechanics) are still separate today, these two worlds are growing together into a uniform, integrated overall system.

Siemens can therefore present itself as a complete supplier for automation technology in which safety engineering is part of the standard automation and system-wide integration exists.

### Additional Information

#### *Brochures*

You can download information material in the Internet:

<http://www.siemens.com/simatic/printmaterial>

# SIMATIC ET 200 fail-safe distributed IO

## SIMATIC ET 200M fail-safe distributed IO

### IM 153-2 High Feature interface module

#### Overview



The ET 200M system with various interface modules is available for the decentralized use of S7-300 I/O modules. Depending on the application purpose, the best suited IM in terms of costs and functions can be selected:

#### IM 153-2 High Feature

For higher requirements in manufacturing technology, such as the **use of F-technology** or the highest performance in conjunction with clock synchronization, the IM 153-2 High Feature is available. This IM is also designed for use with the PCS 7 in the field of manufacturing applications. This IM can be redundantly used and supports typical functions as they are required in the control field. These include, for example, clock synchronization or time stamping with an accuracy of up to 1ms.

#### SIPLUS Version

A SIPLUS version of this module is also available.

Interface module SIPLUS IM 153-2 High Feature	
<b>Order No.</b>	<b>6AG1 153-2BA02-7XB0</b>
<b>Order No. based on</b>	<b>6ES7 153-2BA02-0XB0</b>
Conformal coating	Coating material of circuit boards and of electronic circuitry in accordance with EN 60721
Technical data	The technical data are identical with those of the based-on module, except for the ambient conditions.
Permitted ambient temperature range	-40 ... +70 °C Startup temperature -25 °C
Permitted relative humidity	5 ... 100 %, condensation is allowed
Biologically active substances	Conformity with EN 60721-3-3, Class 3B2 mold and fungal spores (except fauna)
Chemically active substances	Conformity with EN 60721-3-3, Class 3C4 incl. salt mist and ISA-S71_04 severity level G1; G2; G3; GX <sup>1)2)</sup>
Mechanically active substances	Conformity with EN 60721-3-3, Class 3S4 including conductive sand, dust <sup>2)</sup>
Air pressure (depending on the highest positive temperature range specified)	1080 ... 795 hPa (-1000 ... +2000 m) see ambient temperature range 795 ... 658 hPa (+2000 ... +3500 m), derating 10 K 658 ... 540 hPa (+3500 ... +5000 m), derating 20 K

- ISA-S71.04 severity level GX: Long-term load: SO<sub>2</sub> < 4.8 ppm; H<sub>2</sub>S < 9.9 ppm; Cl < 0.2 ppm; HCl < 0.66 ppm; HF < 0.12 ppm; NH < 49 ppm; O<sub>3</sub> < 0.1 ppm; NO<sub>x</sub> < 5.2 ppm  
Limit value (max. 30 min/d): SO<sub>2</sub> < 17.8 ppm; H<sub>2</sub>S < 49.7 ppm; Cl < 1.0 ppm; HCl < 3.3 ppm; HF < 2.4 ppm; NH < 247 ppm; O<sub>3</sub> < 1.0 ppm; NO<sub>x</sub> < 10.4 ppm
- The supplied plug covers must remain in place over the unused interface when operated in atmospheres containing corrosive gases!

Bus modules are also available as SIPLUS versions:

SIPLUS bus module	For accommodating an 80 mm module	For accommodating two IM 153-2
<b>Order No.</b>	<b>6AG1 195-7HC00-2XA0</b>	<b>6AG1 195-7HD10-2XA0</b>
<b>Order No. based on</b>	<b>6ES7 195-7HC00-0XA0</b>	<b>6ES7 195-7HD10-0XA0</b>
Ambient temperature range	-25 ... +70 °C	
Suits standard for "Electronic equipment used on rolling stock" (EN 50155, temperature T1, category 1).	No	Yes
Conformal coating	Coating of the printed circuit boards and the electronic components	
Technical data	The technical data of the standard product applies except for the environmental conditions.	

SIPLUS bus module	For accommodating a PS and an IM 153	For accommodating two 40 mm wide I/O modules
<b>Order No.</b>	<b>6AG1 195-7HA00-2XA0</b>	<b>6AG1 195-7HB00-7XA0</b>
<b>Order No. based on</b>	<b>6ES7 195-7HA00-0XA0</b>	<b>6ES7 195-7HB00-0XA0</b>
Ambient temperature range	-25 ... +70 °C	-25 ... +70 °C
Suits standard for "Electronic equipment used on rolling stock" (EN 50155, temperature T1, category 1).	No	Yes
Conformal coating	Coating of the printed circuit boards and the electronic components	
Technical data	The technical data of the standard product applies except for the environmental conditions.	

Technical documentation for SIPLUS is available at:  
<http://www.siemens.com/siplus-extreme>

#### Application

The IM 153-2 HF interface module is required to connect the modular I/O device ET 200M to the PROFIBUS DP fieldbus.

These heads can be used in many different applications.

#### Special functions and modules for PCS 7

The IM 153-2 (copper) is equipped with special functions, such as clock synchronization, time stamping or I&M functions. In addition, special modules are available that take into account the increased diagnosis requirements in process engineering. For example, digital input modules allow for the connection of NAMUR sensors, have wire-break detectors at "0" and "1" signals and functions such as flatter monitoring or pulse stretching. In order to obtain a reasonable channel price, 8-channel HART modules may be used.

#### Fault-tolerant systems

High availability systems are used in all cases where no system outage is permitted or the system restart after an unscheduled

# SIMATIC ET 200 fail-safe distributed IO

## SIMATIC ET 200M fail-safe distributed IO

### IM 153-2 High Feature interface module

outage is tied to very high costs. Typical applications include, for example, power generation, power distribution, tunnel systems, baggage conveyor systems at airports, oil platforms, oil refineries, the manufacture of special glass, the semiconductor industry, etc.

In conjunction with the high-availability S7-400H (redundant CPUs), the ET 200M can be connected one-way (normal availability) or switched (increased availability).

Furthermore, the IM 153-2 can also be used in applications with S5-155H, with S7-300 / S7-400 with software redundancy as well as with the normal redundancy standardized in the PNO.

#### Area subject to explosion hazard

Various digital and analog modules exist as intrinsically safe versions for the Ex area. This means the modules themselves are installed in Zone 2 cost effectively; however, they can reach the sensors and actuators to be connected up to Zone 1. They are used, for example, in the chemical and pharmaceutical industry, on oil rigs or also in classic manufacturing plants, such as the printing industry or in paint shops in the automobile industry. They allow channel-wise, isolated processing of signals from the Ex zone 1. For use in the non-Ex area, the isolation from channel to channel for these modules is 250 V AC. In addition, there are still HART-capable analog modules.

#### Fail-safe systems

Fail-safe controllers switch to a safe state when a fault occurs and thus protect operators, machines, and the environment, e.g. for presses, robots or passenger transportation. For the connection of fail-safe signals to S7-300F or S7-400F/FH, several signal modules are available that provide SIL 2 or SIL 3 depending on the type of connection.

For the application of safety-related I/O modules, the IM 153-2 HF interface module must be used.

#### Highly dynamic production processes

Distributed solutions for the control of high-speed machines for production and machining processes with high accuracy are becoming increasingly important, e.g. for drive controls. For this reason, the time from the acquisition of a signal by the distributed I/O through to the appropriate response of the actuator must be kept as short and as accurately reproducible as possible. Synchronous coupling of a SIMATIC automation solution to the equidistant PROFIBUS is called "isochronous mode" and is supported by various signal modules of the ET 200M.

#### Design

- The IM 153-1/153-2 interface module serves as the head module (IM; Interface Module) of the ET 200M. Up to 8 or 12 I/O modules from the module product range of the S7-300 automation system can be connected to the interface module.
- The interface module and the necessary I/O modules are assembled on a profile rail for the S7-300. During assembly, the I/O modules are connected to one another using bus connectors and using the IM 153 interface modules.
- For redundant operation, two IM 153-2 are mounted onto the BM IM/IM bus module. Special profile rails are available to accommodate the bus modules.
- When equipping the IM153 with S7-300 modules, slot rules do not have to be taken into account.

#### Function

Features	IM153-2 High Feature 6ES7 153-2BA02-0XB0 6ES7 153-2BA82-0XB0
<b>Mechanical data</b>	
Dimensions (W x H x D)	40 x 125 x 117 mm

Features	IM153-2 High Feature 6ES7 153-2BA02-0XB0 6ES7 153-2BA82-0XB0
<b>PROFIBUS-DP interface</b>	
Physics	RS485 (copper)
PROFIBUS addresses	1 ... 125 (via DIP switch)
Baud rates	9.6 kBd ... 12 MBd
Autom. baud rate search	yes
SYNC / FREEZE capable	yes
<b>Specifications</b>	
Number of insertable modules	12
Number of E / A bytes (user data specifications)	244 / 244
Parameterized data	244
Diagnosis data	96
<b>Module range</b>	
Digital IO / Analog IO	unrestricted / unrestricted
FM	unrestricted
CP	Restricted
F modules	unrestricted
HART modules	unrestricted
IQ Sense	unrestricted
<b>Functionality</b>	
FW update	Yes (PROFIBUS)
I&M data <sup>1)</sup>	yes
Clock synchronization	yes
Module change during operation	yes, with active backplane bus
Clock synchronization	Yes
• Time stamping <sup>2)</sup>	yes
Accuracy class	10 ms / 1 ms
Number of signals/station	128
Redundancy	
• System redundancy with S7-400H	Yes
• Software redundancy	Yes
• S5 redundancy with PLC155H	Yes
• Normal redundancy according to PNO <sup>3)</sup>	yes
Direct data exchange with F modules	yes
Forwards parameterized data from PG / PC ("C2 channel")	yes
Extended range of environmental conditions (outdoors)	Yes (only -2BA82-)
Configuration change in RUN <sup>4)</sup>	
• in the redundant system (H-Cir)	Yes
• In the non-redundant system (Cir)	Yes

- 1) I&M data: Set-up and data access in accordance with the provisions in the PROFIBUS Guideline – Order No. 3.502, Version 1.1 of May 2003
- 2) Changes to digital inputs are tagged with a time stamp locally (in the IM 153 of the ET 200M) and transferred to the CPU by means of a process interrupt. If you want to achieve high-precision time stamping of 1ms with the IM153-2BAx2, a max. of 8 modules per IM can remain plugged in.
- 3) Normal redundancy according to PNO: "Flying Redundancy" according to standard Slave Redundancy Specification V1.2, Nov. 2004 of PROFIBUS International; Order No 2.212.
- 4) Changing the configuration in RUN means that changes to the hardware configuration, e.g. reparameterization or the addition of modules, can be performed during normal operation without any adverse effects.

# SIMATIC ET 200 fail-safe distributed IO

## SIMATIC ET 200M fail-safe distributed IO

### IM 153-2 High Feature interface module

#### How they work

The IM 153 interface module completely handles communication of the modular ET 200M I/O device with the host master device on the PROFIBUS DP.

The inputs and outputs are assigned to the respective master during configuration.

The IM 153-2 interface module allows the design of redundant PROFIBUS DP systems. On failure of the active branch, the passive IM 153-2 takes over the corresponding functions without interruption.

#### Parameterization

##### STEP 7

Configuration is carried out using HW Config by selecting the respective headend from the corresponding HW catalog. The configuration with modules is also carried out from the corresponding HW catalog.

##### Third-party tools

Interfacing to third-party masters and configuration using third-party tools is carried out using the GSD file.

#### Technical specifications

Order No.	6ES7 153-2BA02-0XB0	6ES7 153-2BA82-0XB0
<b>Product type</b>	<b>IM 153-2 High Feature</b>	<b>IM 153-2 High Feature with expanded temperature range</b>
<b>Power supply</b>		
Input voltage		
• Rated value, 24 V DC		
• permissible range, lower limit (DC)		
• permissible range, upper limit (DC)		
Input current		
• Rated value at 24 V DC	650 mA	650 mA
Output voltage		
• Rated value, 5 V DC	Yes	Yes
Output current		
• for backplane bus (5 V DC), max.	1.5 A	1.5 A
<b>Supply voltages</b>		
Rated value		
• 24 V DC	Yes	Yes
• permissible range (ripple included), lower limit (DC)	20.4 V	20.4 V
• permissible range (ripple included), upper limit (DC)	28.8 V	28.8 V
external protection for supply cables (recommendation)	2.5 A	2.5 A
Mains buffering		
• Mains/voltage failure stored energy time	5 ms	5 ms
<b>Current consumption</b>		
Current consumption, max.	600 mA	600 mA
Inrush current, typ.	3 A	3 A
$I^2t$	0.1 A <sup>2</sup> ·s	0.1 A <sup>2</sup> ·s
<b>Power losses</b>		
Power loss, typ.	5.5 W	5.5 W
<b>Address area</b>		

Order No.	6ES7 153-2BA02-0XB0	6ES7 153-2BA82-0XB0
Addressing volume		
• Outputs	244 byte	244 byte
• Inputs	244 byte	244 byte
<b>Hardware configuration</b>		
Number of modules per DP slave interface, max.	12	12
<b>Communication functions</b>		
Bus protocol/transmission protocol	PROFIBUS DP to EN 50170	PROFIBUS DP to EN 50170
<b>Interfaces</b>		
PROFIBUS DP, output current, max.	70 mA	70 mA
Interface physics, RS 485	Yes	Yes
Interface physics, FOC	No	No
<b>Connection method</b>		
PROFIBUS DP	9-pin sub D	9-pin sub D
<b>PROFIBUS DP</b>		
Transmission procedure	RS 485	RS 485
Transmission rate, max.	12 Mbit/s	12 Mbit/s
Node addresses	1 to 125 permitted	1 to 125 permitted
Automatic detection of transmission speed	Yes	Yes
SYNC capability	Yes	Yes
FREECE capability	Yes	Yes
Direct data exchange (slave-to-slave communication)	Yes; Sender	Yes; Sender
<b>1st interface</b>		
DP slave		
• GSD file	SI04801.GSG	SI0480E.GSG
• Automatic baud rate search	Yes	Yes
<b>Programming</b>		
Configuration software		
• STEP 7	Yes; STEP 7 / COM PROFIBUS / non-Siemens tools via GSD file	Yes; STEP 7 / COM PROFIBUS / non-Siemens tools via GSD file
<b>Time stamping</b>		
Accuracy	1 ms; 1ms at up to 8 modules; 10 ms at up to 12 modules	1 ms; 1ms at up to 8 modules; 10 ms at up to 12 modules
Number of message buffers	15	15
Messages per message buffer	20	20
Number of stampable digital inputs, max.	128; max. 128 signals/station; max. 32 signals/slot	128; max. 128 signals/station; max. 32 signals/slot
Time format	RFC 1119	RFC 1119
Time resolution	0.466 ns	0.466 ns
Time interval for transmitting the message buffer if a message is present	1 000 ms	1 000 ms
Time stamp on signal change	rising / falling edge as signal entering or exiting	rising / falling edge as signal entering or exiting



# SIMATIC ET 200 fail-safe distributed IO

## SIMATIC ET 200M fail-safe distributed IO

### IM 153-2 High Feature interface module

Order No.	6ES7 153-2BA02-0XB0	6ES7 153-2BA82-0XB0
<b>Isolation</b>		
Isolation checked with	Isolation voltage 500 V	Isolation voltage 500 V
<b>Environmental requirements</b>		
Operating temperature		
• Min.	0 °C	-25 °C
• max.	60 °C	60 °C
Air pressure		
• Operating altitude above sea level, max.	3 000 m	3 000 m
<b>Degree of protection</b>		
IP20	Yes	Yes
<b>General information</b>		
Vendor identification (VendorID)	801Eh	801Eh
<b>Dimensions and weight</b>		
Dimensions		
• Width	40 mm	40 mm
• Height	125 mm	125 mm
• Depth	117 mm	117 mm
Weight		
• Weight, approx.	360 g	360 g

Active bus module	6ES7 195-7HD10-0XA0
<b>Dimensions and weight</b>	
Dimensions	
• Width	97 mm
• Height	92 mm
• Depth	30 mm
Weight	
• Weight, approx.	133 g

Bus modules	6ES7 195-7HA00-0XA0	6ES7 195-7HB00-0XA0	6ES7 195-7HC00-0XA0
<b>Dimensions and weight</b>			
Dimensions			
• Width	97 mm	97 mm	97 mm
• Height	92 mm	92 mm	92 mm
• Depth	30 mm	30 mm	30 mm
Weight			
• Weight, approx.	111 g	140 g	127 g

#### Selection and ordering data

	Order No.
<b>IM 153-2 interface module</b>	
Slave interface for connecting an ET 200M to PROFIBUS DP; also for use in redundant systems	
• High Feature	<b>6ES7 153-2BA02-0XB0</b>
• High Feature with extended temperature range	<b>6ES7 153-2BA82-0XB0</b>
<b>SIPLUS IM 153-2 interface module</b>	
Same as based-on module 6ES7 153-2BA02-0XB0 (see above), but suitable for extended temperature range and medial exposure	
• High Feature	<b>6AG1 153-2BA02-7XB0</b>
<b>Active IM 153 /IM 153 bus module</b>	<b>6ES7 195-7HD10-0XA0</b>
For two IM 153-2 High Feature modules, for designing redundant systems	
<b>SIPLUS IM 153 /IM 153 bus module</b>	<b>6 AG1 195-7HD10-2XA0</b>
Same as based-on bus module (see above), but suitable for extended temperature range and medial exposure	
<b>Bus module for ET 200M</b>	
• To accommodate a power supply and an IM 153 module for the hot-swapping function during RUN time, incl. bus module cover	<b>6ES7 195-7HA00-0XA0</b>
• SIPLUS version of above bus module	<b>6AG1 195-7HA00-2XA0</b>
• To accommodate two 40-mm wide I/O modules for the hot-swapping function	<b>6ES7 195-7HB00-0XA0</b>
• SIPLUS version of above bus module	<b>6AG1 195-7HB00-7XA0</b>
• To accommodate one 80-mm wide I/O module for the hot-swapping function	<b>6ES7 195-7HC00-0XA0</b>
• SIPLUS version of above bus module	<b>6AG1 195-7HC00-2XA0</b>
<b>ET 200M redundancy bundle</b>	<b>6ES7 153-2AR03-0XA0</b>
Comprising two IM 153-2 High Feature modules and one IM 153/IM 153 bus module	
<b>Accessories</b>	
<b>PROFIBUS bus connector</b>	
90° outgoing cable, terminating resistor with disconnecting function, up to 12 Mbit/s, FastConnect	
Without PG interface:	
• 1 unit	<b>6ES7 972-0BA52-0XA0</b>
• 100 units	<b>6ES7 972-0BA52-0XB0</b>
With PG interface:	
• 1 unit	<b>6ES7 972-0BB52-0XA0</b>
• 100 units	<b>6ES7 972-0BB52-0XB0</b>

# SIMATIC ET 200 fail-safe distributed IO

## SIMATIC ET 200M fail-safe distributed IO

### IM 153-2 High Feature interface module

	Order No.
<b>SIMATIC DP DIN rail for ET 200M</b> Accommodates up to 5 bus modules; for hot-swapping function <ul style="list-style-type: none"> <li>• Length: 483 mm (19")</li> <li>• Length: 530 mm</li> <li>• Length: 620 mm</li> <li>• Length: 2000 mm</li> </ul>	<b>6ES7 195-1GA00-0XA0</b> <b>6ES7 195-1GF30-0XA0</b> <b>6ES7 195-1GG30-0XA0</b> <b>6ES7 195-1GC00-0XA0</b>
<b>SIMATIC S7-300 DIN rail</b> <ul style="list-style-type: none"> <li>• Length: 160 mm</li> <li>• Length: 480 mm (19")</li> <li>• Length: 530 mm</li> <li>• Length: 830 mm</li> <li>• Length: 2000 mm</li> </ul>	<b>6ES7 390-1AB60-0AA0</b> <b>6ES7 390-1AE80-0AA0</b> <b>6ES7 390-1AF30-0AA0</b> <b>6ES7 390-1AJ30-0AA0</b> <b>6ES7 390-1BC00-0AA0</b>
<b>S7 Manual Collection</b> Electronic manuals on DVD, multi-language: S7-200, TD 200, S7-300, M7-300, C7, S7-400, M7-400, STEP 7, Engineering Tools, Runtime Software, SIMATIC DP (Distributed I/O), SIMATIC HMI (Human Machine Interface), SIMATIC NET (Industrial Communication)	<b>6ES7 998-8XC01-8YE0</b>
<b>S7 Manual Collection, update service for 1 year</b> Scope of delivery: Current DVD "S7 Manual Collection" and the three subsequent updates	<b>6ES7 998-8XC01-8YE2</b>

### Additional Information

#### Brochures

You can download information material in the Internet:

<http://www.siemens.com/simatic/printmaterial>

# SIMATIC ET 200 fail-safe distributed IO

## SIMATIC ET 200M fail-safe distributed IO

### IM 154-4 PN High Feature interface module

#### Overview



- To connect ET 200M to PROFINET IO (via copper line, RJ45) as an IO device
- IM 153-4 PN HIGH FEATURE supports the operation of PROFI-safe F and HART modules
- Integrated 2-port switch
- 12 modules per station
- Usable I/O capacity: 192 bytes each
- Active bus backplane to hot-swap modules available as an option
- Baud rate 10 Mbit/s / 100 Mbit/s (autonegotiation / full duplex)
- I&M functions in accordance with PROFIBUS International guideline order no. 3.502, Version V1.1

#### Note:

Micro Memory Card with at least 64 KB required if not all the stations in the network support LLDP (Link Layer Discovery Protocol; proximity detection).

#### Application

The IM 153-4 PN High Feature interface module is used to connect the modular ET 200M I/O device via copper line to the PROFINET fieldbus. It handles communication between the modules and the higher-level PROFINET I/O controller autonomously.

The interface module complements the existing ET 200M PROFIBUS interface product range.

#### Design

- The IM 153-4 PN interface module is used as a header module of the ET 200M. Up to 12 I/O modules from the S7-300 range of programmable controllers can be connected to the interface module. No slot rules apply.
- The interface module and the required I/O modules are mounted on a S7-300 DIN rail. This connects I/O modules with bus connectors and with the IM 153 interface module.
- The IM 153-4 PN is 40 mm wide. The display elements are located at the front along with a slot for the SIMATIC Micro Memory Card (MMC).
- A SIMATIC MMC with at least 64 KB is required for operation.

#### Function

##### Mode of operation

The IM 153-4 PN interface module handles all communication between the modular ET 200M I/O device and the higher-level IO controller via PROFINET.

The inputs and outputs are assigned to the respective IO controller during configuration.

##### Parameterization

- STEP 7; configuration is carried out in HW Config; the respective header module is selected from the corresponding HW catalog. The modules are also configured using the corresponding hardware catalog. As of STEP 7 V5.4, SP2 (HSP138)
- External tools; connection to external masters and configuration with external tools is completed using the GSDML file.

# SIMATIC ET 200 fail-safe distributed IO

## SIMATIC ET 200M fail-safe distributed IO

### IM 154-4 PN High Feature interface module

#### Technical specifications

Order No.	6ES7 153-4BA00-0XB0
<b>Power supply</b>	
Output voltage	
• Rated value, 5 V DC	Yes
Output current	
• for backplane bus (5 V DC), max.	1.5 A
<b>Supply voltages</b>	
Rated value	
• 24 V DC	Yes
• permissible range (ripple included), lower limit (DC)	18.5 V
• permissible range (ripple included), upper limit (DC)	30.2 V
external protection for supply cables (recommendation)	In a construction with grounded reference potential, a fuse is necessary for redundant interface modules (Recommendation: 2.5 A)
Mains buffering	
• Mains/voltage failure stored energy time	5 ms
<b>Current consumption</b>	
Current consumption, max.	600 mA
Inrush current, typ.	4 A
$I^2t$	0.09 A <sup>2</sup> ·s
<b>Power losses</b>	
Power loss, typ.	6 W; typical
<b>Address area</b>	
Addressing volume	
• Outputs	192 byte
• Inputs	672 byte; Extended HART user data
<b>Hardware configuration</b>	
Number of modules per DP slave interface, max.	12
<b>Communication functions</b>	
Bus protocol/transmission protocol	PN IO
<b>Interrupts/diagnostics/status information</b>	
Diagnostics indication LED	
• Connection to network LINK (green)	Yes
• Transmit/receive RX/TX (yellow)	Yes
<b>Isolation</b>	
Isolation checked with	Between Profinet and 24 V supply: 1500 V AC Between functional grounding and 24 V supply: 500 V DC
<b>Environmental requirements</b>	
Operating temperature	
• Min.	0 °C
• max.	60 °C
Air pressure	
• Operating altitude above sea level, max.	2 000 m
<b>Degree of protection</b>	
IP20	Yes
<b>General information</b>	
Vendor identification (VendorID)	002AH
Device identifier (DeviceID)	0302H

Order No.	6ES7 153-4BA00-0XB0
<b>Dimensions and weight</b>	
Dimensions	
• Width	40 mm
• Height	125 mm
• Depth	118 mm
Weight	
• Weight, approx.	215 g

# SIMATIC ET 200 fail-safe distributed IO

## SIMATIC ET 200M fail-safe distributed IO

### IM 154-4 PN High Feature interface module

#### Selection and ordering Data

	Order No.
<b>IM 153-4 PN interface module</b>	
I/O device to connect an ET 200M to PROFINET	
High Feature	<b>6ES7 153-4BA00-0XB0</b>
<b>Accessories</b>	
<b>Bus modules for ET 200M</b>	
<ul style="list-style-type: none"> <li>To accommodate a power supply and an IM 153 for the hot-swapping function during RUN, incl. bus module cover</li> </ul>	<b>6ES7 195-7HA00-0XA0</b>
<ul style="list-style-type: none"> <li>To accommodate two 40-mm wide I/O modules for the hot-swapping function</li> </ul>	<b>6ES7 195-7HB00-0XA0</b>
<ul style="list-style-type: none"> <li>To accommodate one 80-mm wide I/O module for the hot-swapping function</li> </ul>	<b>6ES7 195-7HC00-0XA0</b>
<b>SIMATIC Micro Memory Card</b>	
64 KB <sup>1)</sup>	<b>6ES7 953-8LF20-0AA0</b>
<b>SIMATIC DP DIN rail for ET 200M</b>	
Accommodates up to 5 bus modules; for hot-swapping function	
<ul style="list-style-type: none"> <li>Length: 483 mm (19")</li> <li>Length: 530 mm</li> <li>Length: 620 mm</li> <li>Length: 2000 mm</li> </ul>	<b>6ES7 195-1GA00-0XA0</b> <b>6ES7 195-1GF30-0XA0</b> <b>6ES7 195-1GG30-0XA0</b> <b>6ES7 195-1GC00-0XA0</b>
<b>SIMATIC S7-300 DIN rail</b>	
Length: 160 mm	<b>6ES7 390-1AB60-0AA0</b>
Length: 480 mm (19")	<b>6ES7 390-1AE80-0AA0</b>
Length: 530 mm	<b>6ES7 390-1AF30-0AA0</b>
Length: 830 mm	<b>6ES7 390-1AJ30-0AA0</b>
Length: 2,000 mm	<b>6ES7 390-1BC00-0AA0</b>
<b>S7 Manual Collection</b>	<b>6ES7 998-8XC01-8YE0</b>
Electronic manuals on DVD, multi-language: S7-200, TD 200, S7-300, M7-300, C7, S7-400, M7-400, STEP 7, Engineering Tools, Runtime Software, SIMATIC DP (Distributed I/O), SIMATIC HMI (Human Machine Interface), SIMATIC NET (Industrial Communication)	
<b>S7 Manual Collection update service for 1 year</b>	<b>6ES7 998-8XC01-8YE2</b>
Scope of delivery: Current DVD "S7 Manual Collection" and the three subsequent updates	
<b>Industrial Ethernet FC RJ45 Plug 180</b>	
RJ45 plug connector for Industrial Ethernet with a rugged metal housing and integrated insulation displacement contacts for connecting Industrial Ethernet FC installation cables; with 180° cable outlet	
1 unit	<b>6GK1 901-1BB10-2AA0</b>
10 units	<b>6GK1 901-1BB10-2AB0</b>
50 units	<b>6GK1 901-1BB10-2AE0</b>

	Order No.
<b>Industrial Ethernet Fast Connect installation cables</b>	
<ul style="list-style-type: none"> <li>Fast Connect standard cable</li> <li>Fast Connect trailing cable</li> <li>Fast Connect marine cable</li> </ul>	<b>6XV1 840-2AH10</b> <b>6XV1 840-3AH10</b> <b>6XV1 840-4AH10</b>
<b>Industrial Ethernet Fast Connect</b>	
Stripping Tool	<b>6GK1 901-1GA00</b>

1) To operate the IM153-4, an MMC is required with at least 64 KB memory. Cards with higher memory capacity may also be used.

# SIMATIC ET 200 fail-safe distributed IO

## SIMATIC ET 200M fail-safe distributed IO

### SM 326 F-digital input module - Safety Integrated

#### Overview



- Digital inputs for the fail-safe SIMATIC S7 systems
- For connecting:
  - Switches and 2-wire proximity switches
  - Sensors according to NAMUR and mechanical contacts, also for signals from hazardous areas
- With integral safety functions for fail-safe operation
- Can be used in fail-safe operation
  - Centrally: with S7-31xF-2 DP
  - Distributed in ET 200M: with SIMATIC IM 151-7 F-CPU, S7-31xF-2 DP, S7-416F-2 and S7-400F/FH
- In standard operation can be used in the same way as S7-300 modules

#### SIPLUS Version

SIPLUS versions of this module are also available.

SIPLUS SM 326 F digital input modules		
Order No.	<b>6AG1 326-1BK02-2AB0</b>	<b>6AG1 326-1RF00-4AB0</b>
Order No. based on	<b>6ES7 326-1BK02-0AB0</b>	<b>6ES7 326-1RF00-0AB0</b>
Permitted ambient temperature	-25 ... +60 °C	0 ... +60 °C
Permitted relative humidity	5 ... 100 %, condensation is allowed	
Conformal coating	Coating material of circuit boards and of electronic circuitry in accordance with EN 60721	
Technical data	The technical data are identical with those of the based-on module, except for the ambient conditions.	

Technical documentation for SIPLUS is available at:

<http://www.siemens.com/siplus-extreme>

#### Application

Fail-safe digital input modules are suitable for connecting

- Switches and 2-wire proximity switches (BEROs)
- Sensors according to NAMUR and mechanical contacts, also for signals from hazardous areas

The modules are implemented centrally with SIMATIC S7-31xF-2 DP and in the ET 200M distributed I/O station in combination with SIMATIC IM 151-7 F-CPU, S7-31xF-2 DP, S7-416F-2 and S7-400F/FH. They can also be used in non-safety-relevant standard mode and then respond like standard S7-300 modules.

#### Design

Fail-safe digital input modules have the following mechanical features:

- Compact configuration:
  - The rugged plastic housing contains
  - Green input signal status LEDs
  - Green LED for indicating safety mode
  - Red group fault LED
  - Slot for front connector protected by the front cover
  - Labeling area on the front cover
- Easy installation:
  - Installed in the same way as the other ET 200M I/O modules
- User-friendly wiring via front connector

#### Note:

Cable guide 6ES7 393-4AA10-0AA0 is required in order to operate 6ES7 326-1RF00-0AB0 fail-safe digital input modules in hazardous areas.

#### Function

Fail-safe digital input modules convert the levels of the external digital signals from the process into the internal signal level of the fail-safe SIMATIC S7 CPUs.

The safety functions required for fail-safe operation are integrated in the modules.

#### Technical specifications

Order No.	<b>6ES7 326-1BK02-0AB0</b>	<b>6ES7 326-1RF00-0AB0</b>
Product type	<b>SM 326, 24F-DI, DC 24 V</b>	<b>SM 326, 8F-DI, Namur, Ex</b>
<b>Supply voltages</b>		
Supply voltage of electronics and encoders 1L+/2L+		
• Rated value (DC)	24 V	24 V
<b>Current consumption</b>		
from load voltage L+ (without load), max.	450 mA	160 mA
from backplane bus 5 V DC, max.	100 mA	90 mA
<b>Power losses</b>		
Power loss, typ.	10 W	4.5 W
<b>Connection method</b>		
required front connector	40-pin	40-pin
<b>Digital inputs</b>		
Number of digital inputs	24	8; 8 (one-channel); 4 (two-channel)
Number of simultaneously controllable inputs		
• all mounting positions		
- Concurrently controllable inputs, up to 40 °C	24	8; vertical setup
- Concurrently controllable inputs, up to 60 °C	24; (at 24 V) or 18 (at 28.8 V)	8; horizontal set up
Input voltage		
• Rated value, DC	24 V	in accordance with DIN 19234 or NAMUR
• for signal "0"	-30 to +5 V	

## SM 326 F-digital input module - Safety Integrated

Order No.	6ES7 326-1BK02-0AB0	6ES7 326-1RF00-0AB0
<b>Product type</b>	<b>SM 326, 24F-DI, DC 24 V</b>	<b>SM 326, 8F-DI, Namur, Ex</b>
• for signal "1"	11 to 30 V	
Input current		
• for signal "0", max. (permissible quiescent current)	2 mA	0.35 to 1.2 mA
• for signal "1", typ.	10 mA	2.1 to 7 mA
Input delay (for rated value of input voltage)		
• for standard inputs		
- at "0" to "1", max.	3.4 ms	
- at "1" to "0", max.	3.4 ms	
• for NAMUR inputs		
- at "0" to "1", max.		1.2 to 3 ms
- at "1" to "0", max.		1.2 to 3 ms
Cable length		
• Cable length, shielded, max.	200 m	200 m
• Cable length unshielded, max.	100 m	100 m
<b>Encoder supply</b>		
Number of outputs	4; Isolated	8
Output voltage		8.2 V DC
Output current, rated value	400 mA	
<b>Encoder</b>		
Connectable encoders		
• 2-wire Beros	Yes; if short-circuit test is deactivated	
- permissible quiescent current (2-wire Beros), max.	2 mA	
<b>Ex(i) characteristics</b>		
Module for Ex(i) protection		Yes
Max. values of input circuits (per channel)		
• Co (permissible external capacity), max.		3 µF
• Io (short-circuit current), max.		13.9 mA
• Lo (permissible external inductivity), max.		80 mH
• Po (power of load), max.		33.1 mW
• Uo (output no-load voltage), max.		10 V
• Um (fault voltage), max.		60 V DC/ 30 V AC
• Ta (permissible ambient temperature), max.	60 °C	60 °C
<b>Interrupts/diagnostics/status information</b>		
Alarms		
• Diagnostic alarm	Yes	Yes
Diagnoses		
• Diagnostic information readable	Yes	Yes

Order No.	6ES7 326-1BK02-0AB0	6ES7 326-1RF00-0AB0
<b>Product type</b>	<b>SM 326, 24F-DI, DC 24 V</b>	<b>SM 326, 8F-DI, Namur, Ex</b>
<b>Isolation</b>		
Isolation checked with	500 V DC / 350 V AC	500 VDC
<b>Galvanic isolation</b>		
Galvanic isolation digital inputs		
• between the channels	Yes	Yes
• between the channels, in groups of 12	Yes	Yes
• between the channels and the backplane bus	Yes	Yes
<b>Standards, approvals, certificates</b>		
Test number KEMA		99 ATEX 2671 X
Highest safety class achievable in safety mode		
• acc. to EN 954	Cat. 4	Cat. 3 (single-channel), Cat. 4 (two-channel)
• acc. to IEC 61508	SIL 3	SIL 2 (single-channel), SIL 3 (two-channel)
<b>Dimensions and weight</b>		
Dimensions		
• Width	80 mm	80 mm
• Height	125 mm	125 mm
• Depth	120 mm	120 mm
Weight		
• Weight, approx.	442 g	482 g

## Selection and ordering data

	Order No.
<b>SM 326 F digital input module</b>	
24 inputs, 24 V DC	<b>6ES7 326-1BK02-0AB0</b>
8 inputs, 24 V DC, NAMUR	<b>6ES7 326-1RF00-0AB0</b>
<b>SIPLUS SM 326 F digital input module</b>	
Same as based-on modules (see above), but suitable for extended temperature range and medial exposure	
24 inputs, 24 V DC	<b>6AG1 326-1BK02-2AB0</b>
8 inputs, 24 V DC, NAMUR	<b>6AG1 326-1RF00-4AB0</b>
<b>Distributed Safety V5.4 programming tool</b>	
Task: Software for configuring fail-safe user programs for SIMATIC S7-300F, S7-400F, ET 200S Requirement: STEP 7 V5.3 SP3 and higher	
Floating License	<b>6ES7 833-1FC02-0YA5</b>
Software Update Service	<b>6ES7 833-1FC00-0YX2</b>

# SIMATIC ET 200 fail-safe distributed IO

## SIMATIC ET 200M fail-safe distributed IO

### SM 326 F-digital input module - Safety Integrated

	Order No.
<b>Distributed Safety Upgrade</b> From V5.x to V5.4; Floating license for 1 user	<b>6ES7 833-1FC02-0YE5</b>
<b>Labeling sheet with strips for 10 electronic blocks</b> <ul style="list-style-type: none"> <li>For 16-channel electronic blocks incl. add-on terminals</li> <li>For 32-channel electronic blocks incl. add-on terminals</li> </ul>	<b>6ES7 193-1BH00-0XA0</b> <b>6ES7 193-1BL00-0XA0</b>
<b>Connecting cable for PROFIBUS</b> 12 Mbit/s, for connecting PG to PROFIBUS DP, pre-assembled with 2 x 9-pin Sub-D connector, 3 m	<b>6ES7 901-4BD00-0XA0</b>
<b>PROFIBUS bus connector</b> <ul style="list-style-type: none"> <li>90° cable outlet, terminating resistor with isolating function, without PG socket, up to 12 Mbit/s</li> <li>90° cable outlet, terminating resistor with isolating function, without PG socket, up to 12 Mbit/s</li> <li>90° cable outlet, FastConnect terminating resistor with isolating function, without PG socket, up to 12 Mbit/s; 1 unit - 1 unit - 100 units</li> <li>90° cable outlet, FastConnect terminating resistor with isolating function, with PG socket, up to 12 Mbit/s; 1 unit - 1 unit - 100 units</li> </ul>	<b>6ES7 972-0BA12-0XA0</b> <b>6ES7 972-0BB12-0XA0</b>  <b>6ES7 972-0BA52-0XA0</b> <b>6ES7 972-0BA52-0XB0</b>  <b>6ES7 972-0BB52-0XA0</b> <b>6ES7 972-0BB52-0XB0</b>
<b>DIN rail for active bus modules</b> for max. 5 active bus modules for hot swapping function <ul style="list-style-type: none"> <li>483 mm (19") long</li> <li>530 mm long</li> <li>620 mm long</li> <li>2000 mm long</li> </ul>	<b>6ES7 195-1GA00-0XA0</b> <b>6ES7 195-1GF30-0XA0</b> <b>6ES7 195-1GG30-0XA0</b> <b>6ES7 195-1GC00-0XA0</b>
<b>Active bus module</b> BM 1 x 80 for 1 module with 80 mm width	<b>6ES7 195-7HC00-0XA0</b>
<b>SITOP power supply module</b> for ET 200M; 120/230 V AC, 24 V DC, 5 A; type PS 307-1E	<b>6ES7 307-1EA01-0AA0</b>
<b>Front connectors</b> 40-pin, with screw contacts <ul style="list-style-type: none"> <li>1 unit</li> <li>100 units</li> </ul> 40-pin with spring-loaded contacts <ul style="list-style-type: none"> <li>1 unit</li> <li>100 units</li> </ul> 40-pin, with FastConnect <ul style="list-style-type: none"> <li>1 unit</li> </ul>	<b>6ES7 392-1AM00-0AA0</b> <b>6ES7 392-1AM00-1AB0</b>  <b>6ES7 392-1BM01-0AA0</b> <b>6ES7 392-1BM01-1AB0</b>  <b>6ES7 392-1CM00-0AA0</b>
<b>Labeling strips</b> For fail-safe modules (spare part); 10 units	<b>6ES7 392-2XX20-0AA0</b>

	Order No.
<b>Label cover</b> For fail-safe modules (spare part); 10 units	<b>6ES7 392-2XY20-0AA0</b>
<b>LK 393 cable guide</b> For F modules; L+ and M connections; 5 units	<b>6ES7 393-4AA10-0AA0</b>
<b>S7-300 manual</b> Design, CPU data, module data, instruction list  German English French Spanish Italian	<b>6ES7 398-8FA10-8AA0</b> <b>6ES7 398-8FA10-8BA0</b> <b>6ES7 398-8FA10-8CA0</b> <b>6ES7 398-8FA10-8DA0</b> <b>6ES7 398-8FA10-8EA0</b>
<b>SIMATIC Manual Collection</b> Electronic manuals on DVD, multi-lingual: LOGO!, SIMADYN, SIMATIC bus components, SIMATIC C7, SIMATIC distributed I/O, SIMATIC HMI, SIMATIC Sensors, SIMATIC NET, SIMATIC PC Based Automation, SIMATIC PCS 7, SIMATIC PG/PC, SIMATIC S7, SIMATIC Software, SIMATIC TDC	<b>6ES7 998-8XC01-8YE0</b>
<b>SIMATIC Manual Collection update service for 1 year</b> Current "Manual Collection" DVD and the three subsequent updates	<b>6ES7 998-8XC01-8YE2</b>



# SIMATIC ET 200 fail-safe distributed IO

## SIMATIC ET 200M fail-safe distributed IO

### SM 326 F-digital output module - Safety Integrated

#### Overview



6ES7 326-2BF41-0AB0 (left), 6ES7 326-2BF10-0AB0 (right)

- Digital outputs for the fail-safe SIMATIC S7 systems
- Two versions (1 x current sourcing, 1 x current sinking)
- For connecting solenoid valves, DC contactors and indicator lights
- With integral safety functions for fail-safe operation
- Can be used in fail-safe operation
  - Centrally: with S7-31xF DP, S7-31xF PN/DP
  - Distributed in ET 200M: with SIMATIC IM 151-7 F-CPU, S7-31xF-2 DP, S7-41xF-2 and S7-400F/FH

#### SIPLUS Versions

SIPLUS versions of this module are also available.

SIPLUS SM 326 F-digital output module			
Order No.	6AG1 326-2BF10-2AB0	6AG1 326-2BF41-2AB0	6AG1 326-2BF41-2AY0
Order No. based on	6ES7 326-2BF10-0AB0	6ES7 326-2BF41-2AB0	6ES7 326-2BF41-2AB0
Permitted ambient temperature	-25 ... +60 °C		
Permitted relative humidity	5 ... 100 %, condensation is allowed		
Suits standard for "Electronic equipment used on rolling stock" (EN 50155, temperature T1, category 1).	Yes	No	Yes
Conformal coating	Coating material of circuit boards and of electronic circuitry in accordance with EN 60721		
Technical data	The technical data are identical with those of the based-on module, except for the ambient conditions.		

Technical documentation for SIPLUS is available at:  
<http://www.siemens.com/siplus-extreme>

#### Application

Fail-safe digital output modules are used centrally with SIMATIC S7-31xF-2 DP, and in the ET 200M distributed I/O device together with SIMATIC IM 151-7 F-CPU, S7-31xF-2 DP, S7-416F-2 and S7-400F/FH.

The modules are, for example, suitable for connecting solenoid valves, DC contactors and indicator lights.

In the case of the SM 326 F-DO 10 x DC 24V/2A PP (6ES7 326-2BF10-0AB0), the function "Keep last valid value" can be used optionally in safety mode too. Together with the diagnostics capability of the module, this can be used for cost-optimized implementation of applications in, for example, the area of fire and gas alarm systems (in accordance with EN 54-2/-4 or NFPA72).

#### Design

Fail-safe digital output modules have the following mechanical features:

- Compact design:
  - 2 connections per output for single-channel or redundant actuator control
  - Green LEDs for indicating signal states at the outputs
  - Green LED for indicating safety operation
  - Red LED for group error display
  - Connection options for the front connector, protected behind the front door
  - Labeling field on the front door
- Simple installation: installation is the same as for the other I/O modules of the ET 200M
- User-friendly wiring via the front connector
- Module width:
  - SM 326 F-DO 10 x DC 24V/2A PP (6ES7 326-2BF10-0AB0) single-width (40mm)
  - SM 326 F-DO 8 x DC 24V/2A PM (6ES7 326-2BF41-0AB0) double-width (80 mm)

#### Function

Fail-safe digital output modules convert the internal signal level of the fail-safe SIMATIC S7 CPUs into the external signal levels required for the process. The safety functions required for fail-safe operation are integrated in the modules.

# SIMATIC ET 200 fail-safe distributed IO

## SIMATIC ET 200M fail-safe distributed IO

### SM 326 F-digital output module - Safety Integrated

#### Technical specifications

Order No.	6ES7 326-2BF10-0AB0	6ES7 326-2BF41-0AB0
<b>Product type</b>	<b>SM 326, 10F-DO, DC 24 V, 2 A</b>	<b>SM 326, 8F-DO, DC 24 V, 2 A PM</b>
<b>Supply voltages</b>		
Load voltage L+		
• Rated value (DC)	24 V; 1L+, 2L+, 3L+	24 V; 1L+, 2L+, 3L+
<b>Current consumption</b>		
from load voltage 1L+, max.	100 mA; from supply voltage	75 mA; from supply voltage
from load voltage 2L+ (without load), max.	100 mA	100 mA
from load voltage 3L+ (without load), max.	100 mA	100 mA
from backplane bus 5 V DC, max.	100 mA	100 mA
<b>Power losses</b>		
Power loss, typ.	6 W	12 W
<b>Connection method</b>		
required front connector	40-pin	40-pin
<b>Digital outputs</b>		
Number of digital outputs	10	8
Short-circuit protection	Yes; Electronic	Yes; Electronic
Limitation of inductive shutdown voltage to		L+ (-33 V)
Lamp load, max.	5 W	5 W
<b>Output voltage</b>		
• for signal "1" without series diode, min.		L+ (-1.0 V)
<b>Output current</b>		
• for signal "1" rated value	2 A	2 A
• for signal "1" permissible range for 0 to 40 °C, min.	7 mA	7 mA
• for signal "1" permissible range for 0 to 40 °C, max.		2 A; 2 A for horizontal installation, 1 A for vertical installation
• for signal "1" permissible range for 40 to 60 °C, min.	7 mA	7 mA
• for signal "1" permissible range for 40 to 60 °C, max.		1 A; for horizontal installation
• for signal "0" residual current, max.	0.5 mA	0.5 mA
<b>Switching frequency</b>		
• with resistive load, max.	25 Hz	30 Hz
• with inductive load, max.	25 Hz	2 Hz
• on lamp load, max.	10 Hz	10 Hz
<b>Aggregate current of outputs (per group)</b>		
• horizontal installation		
- up to 40 °C, max.	10 A	7.5 A
- up to 60 °C, max.	6 A	5 A
• vertical installation		
- up to 40 °C, max.	5 A	5 A
<b>Cable length</b>		
• Cable length, shielded, max.	1 000 m	200 m; 200 m for SIL3, AK 6, Cat 4
• Cable length unshielded, max.	600 m	

Order No.	6ES7 326-2BF10-0AB0	6ES7 326-2BF41-0AB0
<b>Product type</b>	<b>SM 326, 10F-DO, DC 24 V, 2 A</b>	<b>SM 326, 8F-DO, DC 24 V, 2 A PM</b>
<b>Interrupts/diagnostics /status information</b>		
Alarms		
• Diagnostic alarm	Yes	Yes; Parameterizable
Diagnoses		
• Diagnostic information readable	Yes	Yes
<b>Isolation</b>		
Isolation checked with	370 V for 1 min	500 V DC / 350 V AC
<b>Galvanic isolation</b>		
Galvanic isolation digital outputs		
• between the channels	Yes	Yes
• between the channels, in groups of 5	5	4
• between the channels and the backplane bus	Yes	Yes
• between the channels and the power supply of the electronics	Yes	Yes
<b>Standards, approvals, certificates</b>		
Highest safety class achievable in safety mode		
• to ISO 13849-1	PL e	
• acc. to EN 954	Cat. 4	Cat. 4
• acc. to IEC 61508	SIL 3	SIL 3
<b>Dimensions and weight</b>		
Dimensions		
• Width	40 mm	80 mm
• Height	125 mm	125 mm
• Depth	120 mm	120 mm
Weight		
• Weight, approx.	330 g	465 g

# SIMATIC ET 200 fail-safe distributed IO

## SIMATIC ET 200M fail-safe distributed IO

### SM 326 F-digital output module - Safety Integrated

#### Selection and ordering data

	Order No.		Order No.
<b>F digital output module SM 326</b>		<b>DIN rail for active bus modules</b>	
10 outputs, 24 V DC, 2 A PP; width 40 mm	<b>6ES7 326-2BF10-0AB0</b>	for max. 5 active bus modules, for function "Insertion and removal"	
8 outputs, 24 V DC, 2 A PM; width 80 mm	<b>6ES7 326-2BF41-0AB0</b>	<ul style="list-style-type: none"> <li>• 483 mm (19") long</li> <li>• 530 mm long</li> <li>• 620 mm long</li> <li>• 2000 mm long</li> </ul>	<b>6ES7 195-1GA00-0XA0</b> <b>6ES7 195-1GF30-0XA0</b> <b>6ES7 195-1GG30-0XA0</b> <b>6ES7 195-1GC00-0XA0</b>
<b>SIPLUS F digital output module SM 326</b>		<b>Active bus modules</b>	
Same as based-on modules (see above), but suitable for extended temperature range and medial exposure		BM 2 x 40 for accepting 2 IO modules each 40 mm wide	<b>6ES7 195-7HB00-0XA0</b>
10 outputs, 24 V DC, 2 A PP; width 40 mm	<b>6AG1 326-2BF10-2AB0</b>	BM 1 x 80 for accepting 1 IO module 80 mm wide	<b>6ES7 195-7HC00-0XA0</b>
8 outputs, 24 V DC, 2 A PM; width 80 mm	<b>6AG1 326-2BF41-2AB0</b>	<b>SITOP power supply module</b>	<b>6ES7 307-1EA01-0AA0</b>
8 outputs, 24 V DC, 2 A PM; width 80 mm, and suitable for rolling stock applications	<b>6AG1 326-2BF41-2AY0</b>	for ET 200M; 120/230 V AC, 24 V DC, 5 A; type PS 307-1E	
<b>Distributed Safety V5.4 programming tool</b>		<b>Front connectors</b>	
Task: Software for configuring fail-safe user programs for SIMATIC S7-300F, S7-400F, ET 200S Requirement: STEP 7 V5.3 SP3 and higher		40-pin, with screw contacts	
Floating License	<b>6ES7 833-1FC02-0YA5</b>	<ul style="list-style-type: none"> <li>• 1 unit</li> <li>• 100 units</li> </ul>	<b>6ES7 392-1AM00-0AA0</b> <b>6ES7 392-1AM00-1AB0</b>
Software Update Service	<b>6ES7 833-1FC00-0YX2</b>	40-pin with spring-loaded contacts	
<b>Distributed Safety Upgrade</b>		<ul style="list-style-type: none"> <li>• 1 unit</li> <li>• 100 units</li> </ul>	<b>6ES7 392-1BM01-0AA0</b> <b>6ES7 392-1BM01-1AB0</b>
From V5.x to V5.4; Floating license for 1 user	<b>6ES7 833-1FC02-0YE5</b>	40-pin, with FastConnect	
<b>Labeling sheet with strips for 10 electronic blocks</b>		<ul style="list-style-type: none"> <li>• 1 unit</li> </ul>	<b>6ES7 392-1CM00-0AA0</b>
<ul style="list-style-type: none"> <li>• For 16-channel electronic blocks incl. add-on terminals</li> <li>• For 32-channel electronic blocks incl. add-on terminals</li> </ul>	<b>6ES7 193-1BH00-0XA0</b>	<b>Labeling strips</b>	<b>6ES7 392-2XX20-0AA0</b>
	<b>6ES7 193-1BL00-0XA0</b>	For fail-safe modules (spare part), 10 units	
<b>Connecting cable for PROFIBUS</b>	<b>6ES7 901-4BD00-0XA0</b>	<b>Label cover</b>	<b>6ES7 392-2XY20-0AA0</b>
12 Mbit/s, for connecting PG to PROFIBUS DP, pre-assembled with 2 x 9-pin Sub-D connector, 3 m		For fail-safe modules (spare part), 10 units	
<b>PROFIBUS bus connector</b>		<b>LK 393 cable guide</b>	<b>6ES7 393-4AA10-0AA0</b>
<ul style="list-style-type: none"> <li>• 90° cable outlet, terminating resistor with isolating function, without PG socket, up to 12 Mbit/s</li> <li>• 90° cable outlet, terminating resistor with isolating function, without PG socket, up to 12 Mbit/s</li> <li>• 90° cable outlet, FastConnect terminating resistor with isolating function, without PG socket, up to 12 Mbit/s; 1 unit <ul style="list-style-type: none"> <li>- 1 unit</li> <li>- 100 units</li> </ul> </li> <li>• 90° cable outlet, FastConnect terminating resistor with isolating function, with PG socket, up to 12 Mbit/s; 1 unit <ul style="list-style-type: none"> <li>- 1 unit</li> <li>- 100 units</li> </ul> </li> </ul>	<b>6ES7 972-0BA12-0XA0</b> <b>6ES7 972-0BB12-0XA0</b>  <b>6ES7 972-0BA52-0XA0</b> <b>6ES7 972-0BA52-0XB0</b>	<b>S7-300 manual</b>	
	<b>6ES7 972-0BB52-0XA0</b>	Design, CPU data, module data, instruction list	
	<b>6ES7 972-0BB52-0XB0</b>	German	<b>6ES7 398-8FA10-8AA0</b>
		English	<b>6ES7 398-8FA10-8BA0</b>
		French	<b>6ES7 398-8FA10-8CA0</b>
		Spanish	<b>6ES7 398-8FA10-8DA0</b>
		Italian	<b>6ES7 398-8FA10-8EA0</b>
		<b>SIMATIC Manual Collection</b>	<b>6ES7 998-8XC01-8YE0</b>
		Electronic manuals on DVD, multi-lingual: LOGO!, SIMADYN, SIMATIC bus components, SIMATIC C7, SIMATIC distributed I/O, SIMATIC HMI, SIMATIC Sensors, SIMATIC NET, SIMATIC PC Based Automation, SIMATIC PCS 7, SIMATIC PG/PC, SIMATIC S7, SIMATIC Software, SIMATIC TDC	
		<b>SIMATIC Manual Collection update service for 1 year</b>	<b>6ES7 998-8XC01-8YE2</b>
		Current "Manual Collection" DVD and the three subsequent updates	

# SIMATIC ET 200 fail-safe distributed IO

## SIMATIC ET 200M fail-safe distributed IO

### SM 336 F-analog input module - Safety Integrated

#### Overview



- Analog inputs for the fail-safe SIMATIC S7 systems
- Applicable in the ET 200M distributed I/O device with IM 153-2 HF as well as centrally with SIMATIC S7-31xF-2 DP
- Properties of the SM 336; F-AI 6 x 0/4 - 20 mA HART:
  - 6 analog inputs with galvanic isolation between channels and backplane bus
  - Input ranges: 0 to 20 mA, 4 to 20 mA
  - Short-circuit proof power supply from 2 or 4-wire transducer via the module
  - External encoder supply possible
  - Applicable in safety mode
  - HART communication
  - Firmware update using HW Config
  - Identification data

#### SIPLUS Version

A SIPLUS version of this module is also available.

SIPLUS SM 336 F-analog input module	
Order No.	6AG1 336-4GE00-4AB0
Order No. based on	6ES7 336-4GE00-0AB0
Permitted ambient temperature	0 ... +60 °C
Permitted relative humidity	5 ... 100 %, condensation is allowed
Conformal coating	Coating material of circuit boards and of electronic circuitry in accordance with EN 60721
Technical data	The technical data are identical with those of the based-on module, except for the ambient conditions.

Technical documentation for SIPLUS is available at: <http://www.siemens.com/siplus-extreme>

#### Application

The modules are used centrally with SIMATIC S7-31xF-2 DP and in the ET 200M distributed I/O device together with SIMATIC IM 151-7 F-CPU, S7-31xF-2 DP, S7-416F-2 and S7-400F/FH.

0 to 20 mA and 4 to 20 mA current transmitters (also HART) can be connected as encoders.

#### Design

- 6 inputs for current measurement.
- Compact design:
  - Group fault display (SF)
  - Safety mode display (SAFE)
  - Display for channel-specific faults (Fn)
  - Display for HART status (Hn)
  - Plug options for the 20-pin front connector, protected behind the front door.
  - Labeling field on the front door.
- Easy assembly:
  - Assembled like the other ET 200M I/O modules.
- User-friendly wiring with 20-pin front connector.

#### Function

The analog input module converts analog signals from the process to digital signals for internal processing by the fail-safe SIMATIC S7 CPUs.

The safety functions required for fail-safe operation are integrated in the module.

The following functions are available:

- Resolution 15 bits + sign.
- Measuring ranges:
  - 0 to 20 mA or
  - 4 to 20 mA or
  - 4 to 20 mA (HART)
- Interrupt capability; the module sends diagnostic interrupts to the CPU of the controller.
- Diagnostics; the module sends extensive diagnostic information to the CPU.

#### Technical specifications

Order No.	6ES7 336-4GE00-0AB0
Product type designation	SM 336 F-AI 6 x 0 / 4 to 20 mA HART
<b>Supply voltages</b>	
Load voltage L+	
• Rated value (DC)	24 V
• Reverse polarity protection	Yes
<b>Current consumption</b>	
from backplane bus 5 V DC, max.	90 mA
from supply voltage L+, max.	150 mA; typical
<b>Power losses</b>	
Power loss, typ.	4.5 W
<b>Connection method</b>	
required front connector	20-pin
<b>Analog inputs</b>	
Number of analog inputs	6
Cable length, shielded, max.	1 000 m
Input ranges (rated values), currents	
• 0 to 20 mA	Yes
• 4 to 20 mA	Yes
Current input	
• permissible input current for current input (destruction limit), max.	40 mA

# SIMATIC ET 200 fail-safe distributed IO

## SIMATIC ET 200M fail-safe distributed IO

### SM 336 F-analog input module - Safety Integrated

<b>Order No.</b>	<b>6ES7 336-4GE00-0AB0</b>
<b>Product type designation</b>	<b>SM 336 F-AI 6 x 0 / 4 to 20 mA HART</b>
<b>Analog value creation</b>	
Integrations and conversion time/resolution per channel	
<ul style="list-style-type: none"> <li>Resolution with overrange (bit including sign), max.</li> </ul>	16 bit; 15 bits + sign
<ul style="list-style-type: none"> <li>Integration time, ms</li> </ul>	20 at 50 Hz 16.7 at 60 Hz
<ul style="list-style-type: none"> <li>Interference voltage suppression for interference frequency f1 in Hz</li> </ul>	$f=n \times (f1 \pm 0.5\%)$
<b>Encoder</b>	
Connection of signal encoders	
<ul style="list-style-type: none"> <li>for current measurement as 2-wire transducer</li> </ul>	Yes
<ul style="list-style-type: none"> <li>for current measurement as 4-wire transducer</li> </ul>	Yes
<b>Errors/accuracies</b>	
Operational limit in overall temperature range	
<ul style="list-style-type: none"> <li>Current, relative to input area</li> </ul>	+/- 0,2 %; 40µA
Basic error limit (operational limit at 25 °C)	
<ul style="list-style-type: none"> <li>Current, relative to input area</li> </ul>	+/- 0,1 %
<b>Interrupts/diagnostics/status information</b>	
Alarms	
<ul style="list-style-type: none"> <li>Diagnostic alarm</li> </ul>	Yes
Diagnoses	
<ul style="list-style-type: none"> <li>Diagnostic information readable</li> </ul>	Yes
<b>Isolation</b>	
Isolation checked with	370 V for 1 min
<b>Galvanic isolation</b>	
Galvanic isolation analog inputs	
<ul style="list-style-type: none"> <li>between the channels</li> </ul>	Yes
<ul style="list-style-type: none"> <li>between the channels and the backplane bus</li> </ul>	Yes
<ul style="list-style-type: none"> <li>between the channels and the power supply of the electronics</li> </ul>	Yes
<b>Standards, approvals, certificates</b>	
Highest safety class achievable in safety mode	
<ul style="list-style-type: none"> <li>acc. to DIN V 19250</li> </ul>	old
<ul style="list-style-type: none"> <li>acc. to EN 954</li> </ul>	Cat. 4
<ul style="list-style-type: none"> <li>acc. to IEC 61508</li> </ul>	SIL 3
<b>Dimensions and weight</b>	
Dimensions	
<ul style="list-style-type: none"> <li>Width</li> </ul>	40 mm
<ul style="list-style-type: none"> <li>Height</li> </ul>	125 mm
<ul style="list-style-type: none"> <li>Depth</li> </ul>	120 mm
Weight	
<ul style="list-style-type: none"> <li>Weight, approx.</li> </ul>	350 g

### Selection and ordering data

	Order No.
<b>F analog input module SM 336</b>	
6 inputs, 15 bit, 0/4 - 20 mA HART	<b>6ES7 336-4GE00-0AB0</b>
<b>SIPLUS F analog input module SM 336</b>	
Same as based-on module (see above), but suitable for extended temperature range and medial exposure	<b>6AG1 336-4GE00-AAB0</b>
6 inputs, 15 bit, 0/4 - 20 mA HART	
<b>Distributed Safety V5.4 programming tool</b>	
Task: Software for configuring fail-safe user programs for SIMATIC S7-300F, S7-400F, ET 200S Requirement: STEP 7 V5.3 SP3 and higher	
Floating License	<b>6ES7 833-1FC02-0YA5</b>
Software Update Service	<b>6ES7 833-1FC00-0YX2</b>
<b>Distributed Safety Upgrade</b>	
From V5.x to V5.4; Floating license for 1 user	<b>6ES7 833-1FC02-0YE5</b>
<b>Labeling sheet with strips for 10 electronic blocks</b>	
<ul style="list-style-type: none"> <li>For 16-channel electronic blocks incl. add-on terminals</li> </ul>	<b>6ES7 193-1BH00-0XA0</b>
<ul style="list-style-type: none"> <li>For 32-channel electronic blocks incl. add-on terminals</li> </ul>	<b>6ES7 193-1BL00-0XA0</b>
<b>Connecting cable for PROFIBUS</b>	<b>6ES7 901-4BD00-0XA0</b>
12 Mbit/s, for connecting PG to PROFIBUS DP, pre-assembled with 2 x 9-pin Sub-D connector, 3 m	
<b>PROFIBUS bus connector</b>	
<ul style="list-style-type: none"> <li>90° cable outlet, terminating resistor with isolating function, without PG socket, up to 12 Mbit/s</li> </ul>	<b>6ES7 972-0BA12-0XA0</b>
<ul style="list-style-type: none"> <li>90° cable outlet, terminating resistor with isolating function, without PG socket, up to 12 Mbit/s</li> </ul>	<b>6ES7 972-0BB12-0XA0</b>
<ul style="list-style-type: none"> <li>90° cable outlet, FastConnect terminating resistor with isolating function, without PG socket, up to 12 Mbit/s; 1 unit</li> </ul>	
<ul style="list-style-type: none"> <li>- 1 unit</li> </ul>	<b>6ES7 972-0BA52-0XA0</b>
<ul style="list-style-type: none"> <li>- 100 units</li> </ul>	<b>6ES7 972-0BA52-0XB0</b>
<ul style="list-style-type: none"> <li>90° cable outlet, FastConnect terminating resistor with isolating function, with PG socket, up to 12 Mbit/s; 1 unit</li> </ul>	
<ul style="list-style-type: none"> <li>- 1 unit</li> </ul>	<b>6ES7 972-0BB52-0XA0</b>
<ul style="list-style-type: none"> <li>- 100 units</li> </ul>	<b>6ES7 972-0BB52-0XB0</b>
<b>DIN rail for active bus modules</b>	
for max. 5 active bus modules for hot swapping function	
<ul style="list-style-type: none"> <li>483 mm long</li> </ul>	<b>6ES7 195-1GA00-0XA0</b>
<ul style="list-style-type: none"> <li>530 mm long</li> </ul>	<b>6ES7 195-1GF30-0XA0</b>
<ul style="list-style-type: none"> <li>620 mm long</li> </ul>	<b>6ES7 195-1GG30-0XA0</b>
<ul style="list-style-type: none"> <li>2000 mm long</li> </ul>	<b>6ES7 195-1GC00-0XA0</b>
<b>Active bus module BM 2x40</b>	<b>6ES7 195-7HB00-0XA0</b>
Bus module for accepting 2 IO modules each 40 mm wide	

# SIMATIC ET 200 fail-safe distributed IO

## SIMATIC ET 200M fail-safe distributed IO

### SM 336 F-analog input module - Safety Integrated

	Order No.
<b>SITOP power supply module</b> for ET 200M; 120/230 V AC, 24 V DC, 5 A; type PS 307-1E	<b>6ES7 307-1EA01-0AA0</b>
<b>Front connectors</b> 20-pin, with screw contacts <ul style="list-style-type: none"> <li>• 1 unit</li> <li>• 100 units</li> </ul> 20-pin, with spring-loaded contacts <ul style="list-style-type: none"> <li>• 1 unit</li> <li>• 100 units</li> </ul> 20-pin, with FastConnect <ul style="list-style-type: none"> <li>• 1 unit</li> </ul>	<b>6ES7 392-1AJ00-0AA0</b> <b>6ES7 392-1AJ00-1AB0</b>  <b>6ES7 392-1BJ00-0AA0</b> <b>6ES7 392-1BJ00-1AB0</b>  <b>6ES7 392-1CJ00-0AA0</b>
<b>Labeling strips</b> For fail-safe modules (spare part), 10 units	<b>6ES7 392-2XX20-0AA0</b>
<b>Label cover</b> For fail-safe modules (spare part), 10 units	<b>6ES7 392-2XY20-0AA0</b>
<b>S7 SmartLabel V3.0</b> Software for automatic labeling of modules direct from the STEP 7 project Single license Upgrade single license	<b>2XV9 450-1SL03-0YX0</b> <b>2XV9 450-1SL03-0YX4</b>
<b>Labeling sheets for machine inscription</b> For 32-channel signal modules, DIN A4, for printing with laser printer; 10 units petrol light-beige yellow red	<b>6ES7 392-2AX10-0AA0</b> <b>6ES7 392-2BX10-0AA0</b> <b>6ES7 392-2CX10-0AA0</b> <b>6ES7 392-2DX10-0AA0</b>
<b>LK 393 cable guide</b> For F modules; L+ and M connections, 5 units	<b>6ES7 393-4AA10-0AA0</b>
<b>S7-300 manual</b> Design, CPU data, module data, instruction list German English French Spanish Italian	<b>6ES7 398-8FA10-8AA0</b> <b>6ES7 398-8FA10-8BA0</b> <b>6ES7 398-8FA10-8CA0</b> <b>6ES7 398-8FA10-8DA0</b> <b>6ES7 398-8FA10-8EA0</b>
<b>SIMATIC Manual Collection</b> Electronic manuals on DVD, multilingual: LOGO!, SIMADYN, SIMATIC bus components, SIMATIC C7, SIMATIC distributed I/O, SIMATIC HMI, SIMATIC Sensors, SIMATIC NET, SIMATIC PC Based Automation, SIMATIC PCS 7, SIMATIC PG/PC, SIMATIC S7, SIMATIC Software, SIMATIC TDC	<b>6ES7 998-8XC01-8YE0</b>
<b>SIMATIC Manual Collection update service for 1 year</b> Current "Manual Collection" DVD and the three subsequent updates	<b>6ES7 998-8XC01-8YE2</b>

# SIMATIC ET 200 fail-safe distributed IO

## SIMATIC ET 200M fail-safe distributed IO

### Isolation module

#### Overview



- Supports mixed operation of fail-safe signal modules in safety mode and S7-300 standard modules in an ET 200M when Cat. 4 or SIL 3 has to be achieved.
- The isolation module is not required if the safety class or safety category to be achieved is less than SIL 3 or Cat. 4, respectively.

#### SIPLUS Version

A SIPLUS version of this module is also available.

SIPLUS S7-300 isolation module	
Order No.	6AG1 195-7KF00-2XA0
Order No. based on	6ES7 195-7KF00-0XA0
Permitted ambient temperature	-25 ... +60 °C
Permitted relative humidity	5 ... 100 %, condensation is allowed
Conformal coating	Coating material of circuit boards and of electronic circuitry in accordance with EN 60721
Technical data	The technical data are identical with those of the based-on module, except for the ambient conditions.

Technical documentation for SIPLUS is available at: <http://www.siemens.com/siplus-extreme>

#### Applications

When Cat. 4/SIL 3 is required, the isolation module must be implemented in the following situations:

Application	Isolation module must be used?
<b>Central use after CPU 31xF-2 DP or CPU 31xF-2 PN/DP</b> <ul style="list-style-type: none"> <li>• Only fail-safe modules in the tier</li> <li>• Standard and fail-safe modules in the tier</li> </ul>	Yes, behind the CPU Yes, after the last standard module and before the first fail-safe module
<b>Central use after CPU 31xF-2 DP or CPU 31xF-2 PN/DP in an expansion rack</b> <ul style="list-style-type: none"> <li>• Only fail-safe modules in the tier</li> <li>• Standard and fail-safe modules in the tier</li> </ul>	Yes, after the IM 36x Yes, after the last standard module and before the first fail-safe module
<b>Distributed behind the IM 153-2 with copper connection</b> <ul style="list-style-type: none"> <li>• Only fail-safe modules in the station</li> <li>• Standard and fail-safe modules in the station</li> </ul>	Yes, after the IM 153-2 Yes, after the last standard module and before the first fail-safe module
<b>Distributed behind the IM 153-2 with fiber-optic connection</b> <ul style="list-style-type: none"> <li>• Only fail-safe modules in the station</li> <li>• Standard and fail-safe modules in the station</li> </ul>	No Yes, after the last standard module and before the first fail-safe module

#### Technical specifications

Order No.	6ES7 195-7KF00-0XA0
<b>Dimensions and weight</b>	
Weight	
• Weight, approx.	10 g

#### Selection and ordering data

	Order No.
<b>S7-300 isolation module</b> for simultaneous operation of fail-safe and standard modules in an ET 200M	6ES7 195-7KF00-0XA0
<b>SIPLUS S7-300 isolation module</b> for simultaneous operation of fail-safe and standard modules in an ET 200M Same as based-on module (see above), but suitable for extended temperature range and medial exposure	6AG1 195-7KF00-2XA0
<b>Isolation bus module</b> for accommodating the isolating module in an ET 200M	6ES7 195-7HG00-0XA0

# SIMATIC ET 200 fail-safe distributed IO

## ET 200eco

### ET 200eco

#### Overview



- Compact, cost-effective I/O devices for processing digital signals
- Design without control cabinet with degree of protection IP65/67 with flexible and fast connections
- Comprises a basic module and various connection blocks for application-specific implementation options:
  - ECOFAST: 2 x RS 485 hybrid fieldbus connection with identification plug for setting the PROFIBUS address
  - M12: 2 x M12 and 2 x 7/8" with 2 rotary coding switches for assigning the PROFIBUS address
- Connection block contains T-functionality for bus and power supply so that during commissioning and service, the modules can be disconnected from and reconnected to the PROFIBUS without interruption
- Module variance: 8DI, 16DI, 8DI/8DO (1.3 A), 8DI/8DO (2.0 A), 8DO (2.0 A), 16DO (0.5 A)
- Transmission rates up to 12 Mbit/s
- **Fail-safe DI modules 4/8 F-DI with safety-related signal processing according to PROFIsafe**

#### Application

ET 200eco is a distributed I/O device to the degree of protection IP65/67. ET 200eco stands for easy handling and installation.

#### Technical specifications

Order No.	6ES7 148-3FA00-0XB0
<b>Supply voltages</b>	
Supply voltage of electronics 1L+	
• Rated value (DC)	24 V
• Reverse polarity protection	No
<b>Current consumption</b>	
from supply voltage 1L+, max.	100 mA
<b>Power losses</b>	
Power loss, typ.	3 W
<b>FH technology</b>	
Module for fail-safe applications	Yes
<b>Protocols</b>	
PROFIBUS DP protocol	Yes
<b>PROFIBUS DP</b>	
Transmission rate, max.	12 Mbit/s
<b>Digital inputs</b>	
Number of digital inputs	8; 8 single channel, 4 two-channel

ET 200eco offers the user the option of low-cost processing of digital signals (also fail-safe) on PROFIBUS DP.

Its high degree of protection and its ruggedness make it particularly suitable for implementation in the machine environment.

The flexible connection blocks can be used to connect to PROFIBUS DP through M12 or through a standardized hybrid fieldbus interface (ECOFAST).

The compact ET 200eco block I/O offers a compatible extension for applications to a high degree of protection alongside the modular I/O product range ET 200X.

#### Function

##### Operating mode

Communication takes place exclusively via PROFIBUS DP.

There are diagnostics functions to monitor the functionality of the ET 200eco:

- BF (bus fault)
- SF (system fault)
- Power supply, encoder and load

The diagnostics data are indicated by LEDs on the module and can be evaluated via software on the programming device or PC or by the PLC

A short-circuit in the encoder supply or a missing load voltage is diagnosed module by module.

The connection block can be removed from the basic module and screwed on again with the equipment live, so PROFIBUS and the power supply remain permanently active in the application.

##### Configuration

A GSD file is available for parameterizing when connecting modules to master modules that are not parameterized with STEP 7. This can be loaded into the configuration tool of the master and provides all the information in plain text for parameterizing the ET 200eco.

For the 4/8F-DI, the F configuration tool that runs under STEP 7 is required for parameterization. This is a component part of S7 Distributed Safety and S7 F systems.

Order No.	6ES7 148-3FA00-0XB0
Number of simultaneously controllable inputs	8; 8 single channel, 4 two-channel
Input characteristic curve acc. to IEC 1131, Type 1	Yes
Input voltage	
• Rated value, DC	24 V
• for signal "0"	-30 to +5 V
• for signal "1"	15 to 30 V
Input current	
• for signal "1", typ.	3.7 mA
Input delay (for rated value of input voltage)	
• for standard inputs	
- at "0" to "1", max.	
- at "1" to "0", max.	
Cable length	
• Cable length unshielded, max.	30 m



Order No.	6ES7 148-3FA00-0XB0
<b>Encoder supply</b>	
Number of outputs	2
Output voltage	min. L+ (-1.5 V)
Output current, rated value	300 mA
Short-circuit protection	Yes
<b>Encoders</b>	
• 2-wire BEROs	Not connectable
<b>Interrupts/diagnostics/status information</b>	
Status indicator	
Alarms	
• Alarms	
Diagnoses	
• Diagnostics	
Diagnostics indication LED	
• Group error SF (red)	Yes
• Status indicator digital input (green)	Yes
• Channel error indicator F (red)	No
<b>Isolation</b>	
Isolation checked with	500 V AC for 1 min.

Order No.	6ES7 148-3FA00-0XB0
<b>Galvanic isolation</b>	
between PROFIBUS DP and all other circuit components	Yes
<b>Galvanic isolation digital inputs</b>	
• between the channels	No
<b>Permissible potential difference</b>	
between different circuits	75 VDC / 60 VAC
<b>Standards, approvals, certificates</b>	
Highest safety class achievable in safety mode	
• acc. to EN 954	Cat. 3 (single-channel), Cat. 4 (two-channel)
• acc. to IEC 61508	SIL 2 (single-channel), SIL 3 (two-channel)
<b>General information</b>	
Vendor identification (VendorID)	
<b>Dimensions and weight</b>	
Dimensions	
• Width	60 mm
• Height	210 mm
• Depth	28 mm
Weight	
• Weight, approx.	220 g

# SIMATIC ET 200 fail-safe distributed IO

## ET 200eco

### ET 200eco

#### Technical specifications of connection blocks

Order No.	6ES7 142-3BF00-0XA0	6ES7 142-3BH00-0XA0
<b>Supply voltages</b>		
Supply voltage of electronics 1L+		
• Rated value (DC)	24 V	24 V
• Reverse polarity protection	Yes	Yes
Load voltage 2L+		
• Rated value (DC)	24 V	24 V
• Reverse polarity protection	Yes	Yes
<b>Current consumption</b>		
from load voltage 2L+ (without load), max.	60 mA; typically	80 mA; typically
from supply voltage 1L+, max.	70 mA; typically	70 mA; typically
<b>Power losses</b>		
Power loss, typ.	4 W	4 W
<b>Protocols</b>		
PROFIBUS DP protocol	Yes	Yes
<b>PROFIBUS DP</b>		
Transmission rate, max.	12 Mbit/s; 9.6 / 19.2 / 45.45 / 93.75 / 187.5 / 500 Kbit/s; 1.5 / 3 / 6 / 12 Mbit/s	12 Mbit/s; 9.6 / 19.2 / 45.45 / 93.75 / 187.5 / 500 Kbit/s; 1.5 / 3 / 6 / 12 Mbit/s
<b>Digital outputs</b>		
Number of digital outputs	8	16
Short-circuit protection	Yes; Electronic	Yes; Electronic
• Response threshold, typ.	4 A per channel	1.4 A (per channel)
Limitation of inductive shutdown voltage to	2L+ (-44 V)	2L+ (-47 V)
Lamp load, max.	10 W	5 W
Controlling a digital input	Yes	Yes
Output voltage		
• for signal "1", min.	2L+ (-0.8 V)	2L+ (-0.8 V)
Output current		
• for signal "1" rated value	2 A	0.5 A
• for signal "1" permissible range for 0 to 55 °C, min.	5 mA	5 mA
• for signal "1" permissible range for 0 to 55 °C, max.	2.4 A	1 A
• for signal "0" residual current, max.	0.5 mA	0.1 mA
Parallel switching of 2 outputs		
• for increased power	No	No
• for redundant control of a load	Yes	Yes
Switching frequency		
• with resistive load, max.	100 Hz	100 Hz
• with inductive load, max.	0.5 Hz; to IEC 947-5-1, DC13	0.5 Hz; to IEC 947-5-1, DC13
• on lamp load, max.	1 Hz	1 Hz
Aggregate current of outputs (per group)		
• up to 55 °C, max.	4 A; 4 A each for sockets X1, X3, X5, X7 and 4 A each for sockets X2, X4, X6, X8; note the current carrying capacity of the cable	4 A; Please note the current carrying capacity of the cable!
Load resistance range		
• lower limit	12 Ω	12 Ω
• upper limit	4 kΩ	4 kΩ

Order No.	6ES7 142-3BF00-0XA0	6ES7 142-3BH00-0XA0
Cable length		
• Cable length unshielded, max.	30 m	30 m
<b>Interrupts/diagnostics/status information</b>		
Status indicator	Yes	Yes
Alarms		
• Alarms	No	No
Diagnoses		
• Diagnostics	Yes; Diagnostic information readable	Yes; Diagnostic information readable
Diagnoses indication LED		
• Group error SF (red)	Yes	Yes
• Status indicator digital output (green)	Yes	Yes
• Channel error indicator F (red)	No	No
<b>Isolation</b>		
Isolation checked with	500 VDC	500 VDC
<b>Galvanic isolation</b>		
between PROFIBUS DP and all other circuit components	Yes	Yes
Galvanic isolation digital outputs		
• between the channels	No	No
<b>Permissible potential difference</b>		
between different circuits	75 VDC / 60 VAC	75 VDC / 60 VAC
<b>General information</b>		
Vendor identification (VendorID)	80DDh	80FBh
<b>Dimensions and weight</b>		
Dimensions		
• Width	60 mm	60 mm
• Height	210 mm	210 mm
• Depth	28 mm	28 mm
Weight		
• Weight, approx.	210 g	210 g

Order No.	6ES7 143-3BH00-0XA0	6ES7 143-3BH10-0XA0
<b>Supply voltages</b>		
Supply voltage of electronics 1L+		
• Rated value (DC)	24 V	24 V
• Reverse polarity protection	No	Yes
Load voltage 2L+		
• Rated value (DC)	24 V	24 V
• Reverse polarity protection	No	Yes
<b>Current consumption</b>		
from load voltage 2L+ (without load), max.	60 mA; typically	60 mA; typically
from supply voltage 1L+, max.	70 mA; typically	70 mA; typically
<b>Power losses</b>		
Power loss, typ.	5 W	5 W
<b>Protocols</b>		
PROFIBUS DP protocol	Yes	Yes
<b>PROFIBUS DP</b>		
Transmission rate, max.	12 Mbit/s; 9.6 / 19.2 / 45.45 / 93.75 / 187.5 / 500 Kbit/s; 1.5 / 3 / 6 / 12 Mbit/s	12 Mbit/s; 9.6 / 19.2 / 45.45 / 93.75 / 187.5 / 500 Kbit/s; 1.5 / 3 / 6 / 12 Mbit/s
<b>Digital inputs</b>		
Number of digital inputs	8	8
Number of simultaneously controllable inputs	8; All mounting positions up to 55 °C	8; All mounting positions up to 55 °C
Input characteristic curve acc. to IEC 1131, Type 1	Yes	Yes
Input voltage		
• Rated value, DC	24 V	24 V
• for signal "0"	-3 to +5 V	-3 to +5 V
• for signal "1"	13 to 30 V	13 to 30 V
Input current		
• for signal "1", typ.	7 mA	7 mA
Input delay (for rated value of input voltage)		
• for standard inputs		
- at "0" to "1", max.	3 ms; typ.	3 ms; typ.
- at "1" to "0", max.	3 ms; typically	3 ms; typically
<b>Digital outputs</b>		
Number of digital outputs	8	8
Short-circuit protection	Yes; Electronic	Yes; Electronic
• Response threshold, typ.	4 A per channel	4 A per channel
Limitation of inductive shutdown voltage to	2L+ (-44 V)	2L+ (-44 V)
Lamp load, max.	10 W	10 W
Controlling a digital input	Yes	Yes
Output voltage		
• for signal "1", min.	2L+ (-0.8 V)	2L+ (-1.2 V)
Output current		
• for signal "1" rated value	2 A	1.3 A
• for signal "1" permissible range for 0 to 55 °C, min.	5 mA	5 mA
• for signal "1" permissible range for 0 to 55 °C, max.	2.4 A	1.8 A
• for signal "0" residual current, max.	0.5 mA	0.5 mA
Parallel switching of 2 outputs		
• for increased power	No	No
• for redundant control of a load	Yes	Yes
Switching frequency		
• with resistive load, max.	100 Hz	100 Hz

Order No.	6ES7 143-3BH00-0XA0	6ES7 143-3BH10-0XA0
• with inductive load, max.	0.5 Hz; to IEC 947-5-1, DC13	0.5 Hz; to IEC 947-5-1, DC13
• on lamp load, max.	1 Hz	1 Hz
Aggregate current of outputs (per group)		
• up to 55 °C, max.	4 A; 4 A each for sockets X1, X3, X5, X7 and 4 A each for sockets X2, X4, X6, X8; note the current carrying capacity of the cable	5.2 A; Please note the current carrying capacity of the cable!
Load resistance range		
• lower limit	12 Ω	12 Ω
• upper limit	4 kΩ	4 kΩ
Cable length		
• Cable length unshielded, max.	30 m	30 m
<b>Encoder supply</b>		
Number of outputs	8	8
Output voltage	24 V DC	
Output current, rated value	0.75 A; up to 55°C max. 0.75 A (summation current)	1 A; up to 55°C max. 1 A (summation current)
Short-circuit protection	Yes; electronic	Yes; electronic
<b>Encoder</b>		
Connectable encoders		
• 2-wire BEROS	Yes	Yes
- permissible quiescent current (2-wire BEROS), max.	1.5 mA	1.5 mA
<b>Interrupts/diagnostics/status information</b>		
Status indicator	Yes	Yes
Alarms		
• Alarms	No	No
Diagnoses		
• Diagnostics	Yes; diagnostic information readable	Yes; diagnostic information readable
Diagnoses indication LED		
• Group error SF (red)	Yes	Yes
• Status indicator digital output (green)	Yes	Yes
• Status indicator digital input (green)	Yes	Yes
• Channel error indicator F (red)	No	No
<b>Isolation</b>		
Isolation checked with	500 VDC	500 VDC
<b>Galvanic isolation</b>		
between PROFIBUS DP and all other circuit components	Yes	Yes
Galvanic isolation digital inputs		
• between the channels	No	No
Galvanic isolation digital outputs		
• between the channels	No	No
<b>Permissible potential difference</b>		
between different circuits	75 VDC / 60 VAC	75 VDC / 60 VAC

## SIMATIC ET 200 fail-safe distributed IO

## ET 200eco

## ET 200eco

Order No.	6ES7 143-3BH00-0XA0	6ES7 143-3BH10-0XA0
<b>General information</b>		
Vendor identification (VendorID)	80DCh	80FCh
<b>Dimensions and weight</b>		
Dimensions		
• Width	60 mm	60 mm
• Height	210 mm	210 mm
• Depth	28 mm	28 mm
Weight		
• Weight, approx.	210 g	210 g

Order No.	6ES7 194-3AA00-0AA0	6ES7 194-3AA00-0BA0
<b>Power losses</b>		
Power loss, typ.	2 W; the power loss depends on the current that you loop through via the connection block.	2 W; the power loss depends on the current that you loop through via the connection block.
<b>Dimensions and weight</b>		
Dimensions		
• Width	79 mm	79 mm
• Height	60 mm	60 mm
• Depth	30 mm	29 mm
Weight		
• Weight, approx.	313 g	392 g

## Selection and ordering data

	Order No.		Order No.
<b>ET 200eco basic module BM 142</b>		<b>PROFIBUS M12 connecting cable</b>	
<ul style="list-style-type: none"> <li>8 DO DC 24 V/1.2 A 8 x M12, individual assignment, IP65/67 connection block 6ES7 194-3AA00-0.A0 to be ordered separately</li> <li>16 DO DC 24 V/0.5 A 8 x M12, double assignment, IP65/67; connection block 6ES7 194-3AA00-0.A0 to be ordered separately</li> </ul>	<b>6ES7 142-3BF00-0XA0</b>  <b>6ES7 142-3BH00-0XA0</b>	Pre-assembled 2-wire (inverse coded) with M12 connectors (straight) in various lengths: <ul style="list-style-type: none"> <li>0.3 m</li> <li>0.5 m</li> <li>1.0 m</li> <li>1.5 m</li> <li>2.0 m</li> <li>3.0 m</li> <li>5.0 m</li> <li>10.0 m</li> <li>15.0 m</li> <li>Other special lengths with 90° or 180° cable outlet</li> </ul>	<b>6XV1 830-3DE30</b> <b>6XV1 830-3DE50</b> <b>6XV1 830-3DH10</b> <b>6XV1 830-3DH15</b> <b>6XV1 830-3DH20</b> <b>6XV1 830-3DH30</b> <b>6XV1 830-3DH50</b> <b>6XV1 830-3DN10</b> <b>6XV1 830-3DN15</b> see <a href="http://support.automation.siemens.com/WWW/view/en/26999294">http://support.automation.siemens.com/WWW/view/en/26999294</a>
<b>ET 200eco basic modules BM 143</b>		<b>7/8" connector</b>	
<ul style="list-style-type: none"> <li>8 DI/8 DO, 2 A 8 x M12, IP65/67 connection block 6ES7 194-3AA00-0.A0 to be ordered separately</li> <li>8 DI/8 DO, 1.3 A 8 x M12, double assignment, IP65/67 connection block 6ES7 194-3AA00-0.A0 to be ordered separately</li> </ul>	<b>6ES7 143-3BH00-0XA0</b>  <b>6ES7 143-3BH10-0XA0</b>	1 pack = 5 units <ul style="list-style-type: none"> <li>Male contact insert, straight</li> <li>Male contact insert, angled</li> <li>Female contact insert, straight</li> <li>Female contact insert, angled</li> </ul>	<b>6GK1 905-0FA00</b> <b>3RK1 902-3BA00</b> <b>6GK1 905-0FB00</b> <b>3RK1 902-3DA00</b>
<b>ET 200eco basic modules BM 148</b>		<b>7/8" covering caps</b>	
<ul style="list-style-type: none"> <li>4/8 F-DI, 8 x M12, connection block 6ES7 194-3AA00-0.A0 to be ordered separately</li> </ul>	<b>6ES7 148-3FA00-0XBO</b>	1 pack = 10 units	<b>6ES7 194-3JA00-0AA0</b>
<b>ECOFAST connection block</b>	<b>6ES7 194-3AA00-0AA0</b>	<b>SIMATIC NET energy cable</b>	
for ET 200eco, 2 x ECOFAST connection RS485 identification connector for PROFIBUS DP, address setting		5-wire energy cable, stranded 5 x 1.5 mm <sup>2</sup> , trailing-type <ul style="list-style-type: none"> <li>Sold by the meter, minimum order quantity = 20 m</li> </ul>	<b>6XV1 830-8AH10</b>
<b>M12 connection block, 7/8"</b>	<b>6ES7 194-3AA00-0BA0</b>	<b>7/8" connecting cable to power supply</b>	
for ET 200eco, 2 x M12 and 2 x 7/8" 2 rotary coding switch for PROFIBUS DP, address setting		Pre-assembled 5-wire cable with 7/8" connectors (straight) in various lengths: <ul style="list-style-type: none"> <li>0.3 m</li> <li>0.5 m</li> <li>1.0 m</li> <li>1.5 m</li> <li>2.0 m</li> <li>3.0 m</li> <li>5.0 m</li> <li>10.0 m</li> <li>15.0 m</li> </ul>	<b>6XV1 822-5BE30</b> <b>6XV1 822-5BE50</b> <b>6XV1 822-5BH10</b> <b>6XV1 822-5BH15</b> <b>6XV1 822-5BH20</b> <b>6XV1 822-5BH30</b> <b>6XV1 822-5BH50</b> <b>6XV1 822-5BN10</b> <b>6XV1 822-5BN15</b>
<b>Accessory for ECOFAST connection block</b>		<b>PROFIBUS ECOFAST terminating plug</b>	
<b>PROFIBUS ECOFAST hybrid plug</b>		ECOFAST terminating resistor for PROFIBUS DP <ul style="list-style-type: none"> <li>1 pack = 1 unit</li> <li>1 pack = 5 units</li> </ul>	<b>6GK1 905-0DA10</b> <b>6GK1 905-0DA00</b>
<ul style="list-style-type: none"> <li>Female contact insert, straight</li> <li>Female contact insert, angled</li> <li>Male contact insert, straight</li> <li>Male contact insert, angled</li> </ul>	<b>6GK1 905-0CB00</b> <b>6GK1 905-0CD00</b>  <b>6GK1 905-0CA00</b> <b>6GK1 905-0CC00</b>	<b>PROFIBUS ECOFAST</b>	See ECOFAST bus cables
<b>PROFIBUS ECOFAST hybrid plug</b>		Hybrid cable – Cu	
<b>PROFIBUS ECOFAST terminating plug</b>		<b>M12 connection block, 7/8" accessories</b>	
ECOFAST terminating resistor for PROFIBUS DP <ul style="list-style-type: none"> <li>1 pack = 1 unit</li> <li>1 pack = 5 units</li> </ul>	<b>6GK1 905-0DA10</b> <b>6GK1 905-0DA00</b>	<b>PROFIBUS M12 cable connector</b>	
<b>PROFIBUS ECOFAST</b>		1 pack = 5 units <ul style="list-style-type: none"> <li>Male insert</li> <li>Female insert</li> </ul>	<b>6GK1 905-0EA00</b> <b>6GK1 905-0EB00</b>
<b>PROFIBUS ECOFAST</b>		<b>PROFIBUS M12 connecting cable</b>	
Hybrid cable – Cu		for PROFIBUS DP, 1 pack = 5 units <ul style="list-style-type: none"> <li>Male insert</li> </ul>	<b>6GK1 905-0EC00</b>
<b>M12 connection block, 7/8" accessories</b>		<b>Other accessories</b>	
<b>PROFIBUS M12 cable connector</b>		<b>Identification connector</b>	
1 pack = 5 units <ul style="list-style-type: none"> <li>Male insert</li> <li>Female insert</li> </ul>	<b>6GK1 905-0EA00</b> <b>6GK1 905-0EB00</b>	for setting of the PROFIBUS node address	<b>6ES7 194-1KB00-0XA0</b>
<b>PROFIBUS M12 connecting cable</b>		<b>Y circular connector M12</b>	
for PROFIBUS DP, 1 pack = 5 units <ul style="list-style-type: none"> <li>Male insert</li> </ul>	<b>6GK1 905-0EC00</b>	For double connection of sensors via a single cable, 5-pole; cannot be used for F DI 4/8	<b>6ES7 194-1KA01-0XA0</b>

# SIMATIC ET 200 fail-safe distributed IO

## ET 200eco

### ET 200eco

	Order No.
<b>Y cable M12</b> For double connection of sensors via a single cable, 5-pole; cannot be used for F DI 4/8	<b>6ES7 194-6KA00-0XA0</b>
<b>M12 coupler plug</b> for connecting actuators or sensors, 5-pole	<b>3RK1 902-4BA00-5AA0</b>
<b>M12 covering caps</b> for sealing of unused I/O sockets	<b>3RX9 802-0AA00</b>
<b>Labels</b>	<b>3RT1 900-1SB20</b>
<b>Module description "Distributed I/O device ET 200eco" excluding F-DI</b> <ul style="list-style-type: none"> <li>• paper version, German</li> <li>• paper version, English</li> <li>• paper version, French</li> </ul>	<b>6ES7 198-8GA00-8AA0</b> <b>6ES7 198-8GA00-8BA0</b> <b>6ES7 198-8GA00-8CA0</b>
<b>"Distributed Safety" V5.4 F programming tool</b> Floating License for 1 user, with documentation, 3 languages (German, English, French), on CD, runs on STEP 7 V5.3 SP3 or higher	<b>6ES7 833-1FC02-0YA5</b>
<b>"Distributed Safety" F programming tool</b> Upgrade from V5.x to V5.4	<b>6ES7 833-1FC02-0YE5</b>
<b>"Distributed Safety" F programming tool</b> Software Update Service for 1 year, with automatic extension; latest software version required	<b>6ES7 833-1FC00-0YX2</b>
<b>S7 Manual Collection</b> Electronic manuals on DVD, multi-language: S7-200, TD 200, S7-300, M7-300, C7, S7-400, M7-400, STEP 7, Engineering Tools, Runtime Software, SIMATIC DP (Distributed I/O), SIMATIC HMI (Human Machine Interface), SIMATIC NET (Industrial Communication)	<b>6ES7 998-8XC01-8YE0</b>
<b>S7 Manual Collection update service for 1 year</b> Scope of delivery: Current DVD "S7 Manual Collection" and the three subsequent updates	<b>6ES7 998-8XC01-8YE2</b>

3

## Overview

AS-Interface: ASIsafe		Order No.	Page
	<p>ASIsafe enables the integration of safety-oriented components in an AS-Interface network, for example:</p> <ul style="list-style-type: none"> <li>• EMERGENCY-STOP pushbuttons</li> <li>• Protective door switches</li> <li>• Safety light arrays</li> </ul> <p>The simple wiring of AS-Interface, which is a major advantage, is maintained.</p> <p><b>AS-Interface safety monitors</b></p> <ul style="list-style-type: none"> <li>• Key element of ASIsafe</li> <li>• For monitoring safe stations and for linking AS-Interface inputs and outputs</li> <li>• Ensures safe disconnection</li> <li>• Available with one or two release circuits with 2-channel configuration</li> <li>• All versions with removable screw terminals or spring-type terminals</li> <li>• All safety monitors in revised Version 3 with additional options</li> <li>• Filtering out of brief single-channel interruptions in the sensor circuit with the expanded safety monitor Version 3</li> <li>• Expanded safety monitor with integrated safe slave for controlling a distributed safe AS-i output or for safe coupling a safe signal from one AS-i network to another AS-i network</li> <li>• Configuration software ASIMON V3 with graphic function diagram presentation</li> </ul> <p><b>Your advantage:</b> <a href="#">Easy to configure safety functions up to Category 4, PL e, SIL 3.</a></p>	<b>3RK1</b>	3/175
	<p><b>AS-Interface safety modules</b></p> <ul style="list-style-type: none"> <li>• Complete portfolio of ASIsafe modules</li> <li>• For connection of safety switches with contacts (position switches etc.) as well as solid-state safety sensors (BWS)</li> <li>• Degree of protection IP65/IP67 or IP20</li> <li>• Very compact dimensions, from 20 mm width</li> <li>• Up to four safe inputs per module</li> <li>• Up to one safe output per module</li> <li>• Standard outputs are available on the module in addition</li> <li>• Up to Category 4, PL e, SIL 3</li> </ul> <p><b>Your advantage:</b> <a href="#">Easy integration of safe signals, in the control cabinet or in the field.</a></p>	<b>3RK1</b>	3/178
	<p><b>SIRIUS 3SF1, 3SF3 position switches for AS-Interface</b></p> <ul style="list-style-type: none"> <li>• Plastic with degree of protection IP65 and metal with degree of protection IP66/IP67</li> <li>• ASIsafe Electronics integrated in the enclosure, with low power consumption &lt; 60 mA</li> <li>• Available with separate actuator and tumbler</li> </ul> <p><b>Your advantage:</b> <a href="#">Conventional wiring of safety safety functions required no longer required.</a></p>	<b>3SF1, 3SF3</b>	Ch. 2
	<p><b>SIRIUS 3SF2 cable-operated switches for AS-Interface</b></p> <ul style="list-style-type: none"> <li>• Degree of protection IP65</li> <li>• Direct connection of cable-operated switches for detection of signals</li> <li>• Metal enclosures</li> </ul>	<b>3SF2</b>	Ch. 2
	<p><b>SIRIUS EMERGENCY-STOP mushroom pushbuttons for AS-Interface</b></p> <ul style="list-style-type: none"> <li>• Degree of protection IP65/IP67</li> <li>• EMERGENCY-STOP directly on AS-Interface using integrated modules</li> <li>• Metal or plastic version</li> </ul> <p><b>Your advantage:</b> <a href="#">Easy direct connection of service-proven control elements to ASIsafe.</a></p>	<b>3SF5</b>	Ch. 2
	<p><b>AS-Interface F adapters for EMERGENCY-STOP devices</b></p> <ul style="list-style-type: none"> <li>• Connection of an EMERGENCY-STOP device according to ISO 13850 to AS-Interface</li> <li>• Is snap-mounted from behind onto the EMERGENCY-STOP device (actuator)</li> <li>• Safety category 4 (SIL 3)</li> </ul> <p><b>Your advantage:</b> <a href="#">Easy direct connection of service-proven control elements to ASIsafe.</a></p>	<b>3SF5</b>	Ch. 2

## Introduction

Order No. Page

## AS-Interface: Masters

The AS-Interface master connects SIMATIC control systems to AS-Interface. It automatically organizes the data traffic on the AS-Interface cable and sees not only to querying the signals but also to performing the parameter setting, monitoring and diagnostics functions.

**Masters for SIMATIC**

- Connection of up to 62 AS-Interface slaves
- Connection of up to 496 digital inputs and 496 outputs per master or AS-Interface network
- Integrated analog value transmission
- Simple configuration by adopting the actual configuration on the AS-Interface network at the press of a button
- Easy operation in the input/output address area of the SIMATIC S7 comparable to standard I/O modules
- Monitoring of the supply voltage on the AS-Interface shaped cable

Your advantage: [Easy connection to SIMATIC S7-300, ET 200 M or SIMATIC S7-200.](#)

6GK7

3/181

CP 343-2, CP 343-2P  
for SIMATIC S7-300CP 243-2 for  
SIMATIC S7-200

## AS-Interface: Routers

As an alternative to the CPs, which are plugged directly in the controller it is also possible to use a link as AS-Interface master – at any position beneath the PROFIBUS DP or PROFINET IO.

**Routers**

- Degree of protection IP20
- PROFIBUS slave or PROFINET IO device and AS-Interface master (single or double master in case of DP/AS-i LINK Advanced and IE/AS-i LINK PN IO)
- Connection of up to 62 AS-Interface slaves
- Connection of up to 496 digital inputs and 496 outputs per AS-i network, with doubling of the project data volume for double master versions
- Integrated ground-fault monitoring (in case of DP/AS-i LINK Advanced and IE/AS-i LINK PN IO)
- User-friendly local diagnostics and local start-up by means of a full graphic display and control keys or through a web interface with a standard browser (in case of DP/AS-i LINK Advanced and IE/AS-i LINK PN IO)
- Integrated analog value transmission
- Configuring and uploading of AS-Interface configuration in STEP 7 possible
- User-friendly selection of AS-Interface slaves
- Safety-orientated transition from ASIsafe to PROFIsafe also available as DP/AS-i F-Link

Your advantage: [Optimum transition to PROFIBUS or PROFINET, integrated in STEP 7.](#)

3RK3  
6GK13/188  
3/183, 3/186,  
3/191

DP/AS-i LINK Advanced



DP/AS-Interface Link 20E



DP/AS-i F-Link



IE/AS-i LINK PN IO

Note:

- Screw terminals
- Spring-type terminals
- Combicon connectors (plug-in screw terminals)
- Fast Connect

The terminals are indicated in the selection and ordering data by orange backgrounds.



## Overview

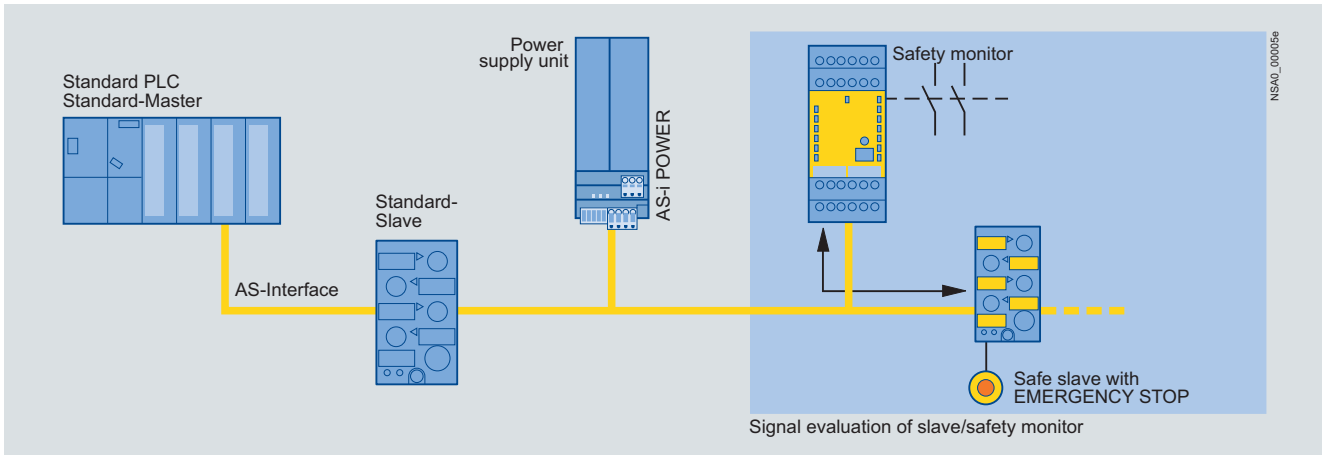

Secure communication and standard communication on AS-Interface

### Safety is included

The ASIsafe concept supports the integration of safety-related components, such as EMERGENCY-STOP switches, protective door switches or safety light arrays, in the AS-Interface network. These are fully compatible with the familiar AS-Interface components (masters, slaves, power supplies, repeaters, etc.) in accordance to IEC 62062/EN 50295 and are operated in conjunction with them on the yellow AS-Interface cable.

A fail-safe controller or a special master is not required. The master regards safety slaves like all other slaves and receives the safety data solely for information purposes. All existing AS-Interface networks can thus be expanded. ASIsafe makes sure that a maximum response time of 40 ms can be achieved. This is the time between the signal being applied to the input of the safe slave and the output on the safety monitor being switched off. With distributed disconnection through a safe AS-i output, the response time is extended by the time (30 ms) which the safe AS-i output requires in addition to the disconnection to a total of 70 ms (worst case).

### Tested safety

The system was tested and approved by TÜV (Germany), NRTL (USA) and INRS (France). The transmission procedure for safety-oriented signals is configured for implementing applications up to Category 4 according to EN 954-1, up to PL e according to EN ISO 13849-1 and up to SIL 3 according to IEC 61508.

### Design

The design of the safety systems is identical to the wiring of AS-Interface as it is known today.

The family of safe AS-Interface products includes the safety monitor which monitors or disconnects the safe stations. The range of safe stations comprises the safety modules and the safety-related sensors with integrated interface. Sensors, monitors and safe AS-i outputs can be connected to any points of the AS-Interface network. Also, several monitors can be used on one network.

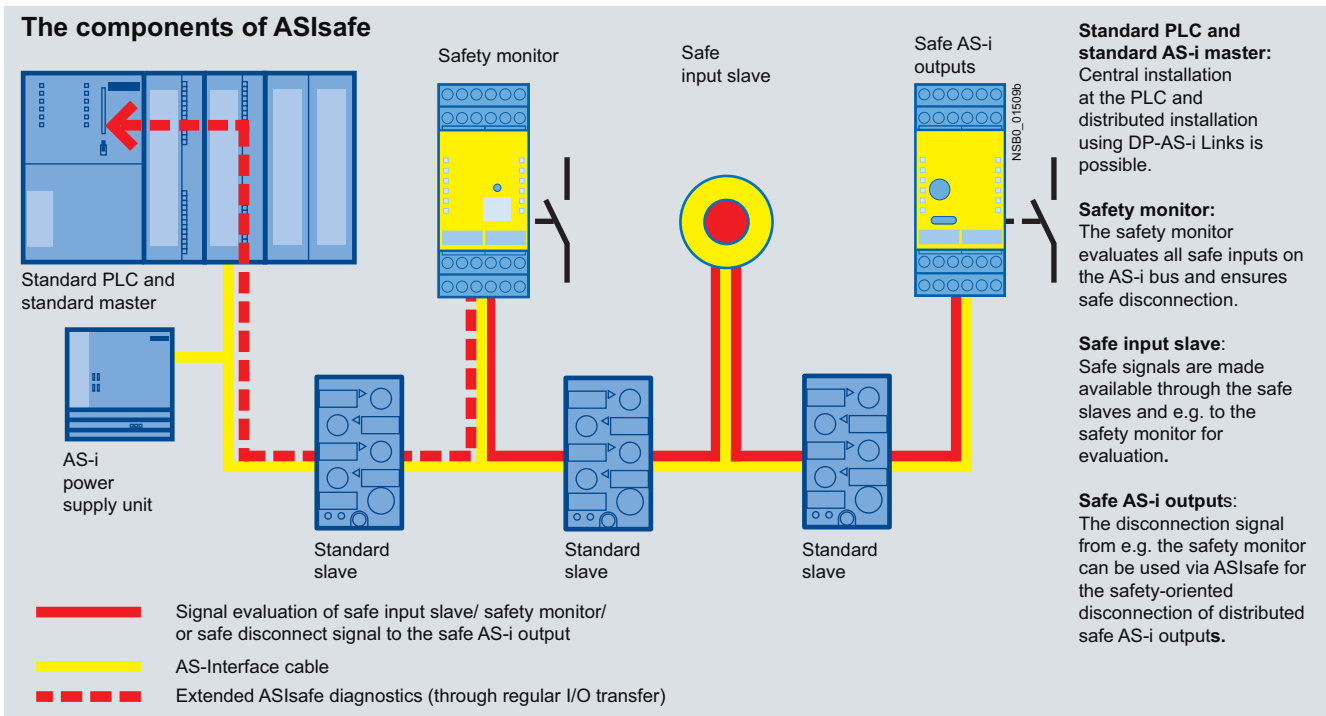

The ASIsafe components and their signal flows

# AS-Interface

## ASIsafe

### Introduction

#### Function

Like the standard stations, the safe stations send their information to the master after master calls.

The safety monitor monitors this transmission from the safe stations to the master and switches to the safe state or sends a disconnect signal to one or more distributed safe AS-i outputs which switch in turn to the safe state.

The safety monitor provides OR logic, AND logic, timer functions, buffer storage, etc.

#### Software

With the ASIMON configuration software you can configure safety-oriented applications and transfer them into the monitor. The configuration comprises the input signals of the safe stations and the internal functions of the safety monitor.

The software also enables online diagnostics.

#### Integration

The existing infrastructure such as the master and the power supply unit can be used as before for integrating the safety systems in AS-Interface. For the safety systems the safety monitor is integrated as monitoring element and the safe stations as interface between the safe sensors and the system. The safe sensors can be used as before.

Integration within TIA is performed using function blocks which are offered on the ASIsafe CD-ROM for S7-200 and S7-300. These function blocks enable detailed diagnostics of all parameterized modules. This requires an AS-i address to be issued to the safety monitor by means of the configuration software. Evaluation is performed by means of function blocks in the PLC. With the help of prefabricated WinCC flexible modules this evaluation can then be visualized system-wide on existing HMI devices (OP/TP 270 and higher).

**Permanent Fenster (Header)**

Anwahl ASI Monitor: Monitor 2

**Master Status**

Monitor: Schutzbetrieb, alles ok  
LED Kreis 1: grün, eingeschaltet  
LED Kreis 2: grün, eingeschaltet

Kreis 1, Device Status										Kreis 2, Device Status									
32	33	34	35	36	37	38	39	40	41	32	33	34	35	36	37	38	39	40	41
42	43	44	45	46	47	48	49	50	51	42	43	44	45	46	47	48	49	50	51
52	53	54	55	56	57	58	59	60	61	52	53	54	55	56	57	58	59	60	61
62	63	64	65	66	67	68	69	70	71	62	63	64	65	66	67	68	69	70	71
72	73	74	75	76	77	78	79			72	73	74	75	76	77	78	79		

XX eingeschaltet      XX eingeschaltet, Abschalttimer läuft      XX Test (aus->ein) erforderlich      XX keine Kommunikation  
XX bereit, warte auf Quitterung      XX ausgeschaltet      XX Fehler      XX Konfigurationsbetrieb  
XX unbekannt / nicht benutzt

AS-I Diagnose      Hauptmenü

Diagnostics interface for ASIsafe components via S7-200 or S7-300

#### Benefits

- No fail-safe PLC or special master is required for the ASIsafe Solution local (safety monitor)
- Alternatively integration in SIMATIC / SINUMERIK safety architectures with the help of DP/AS-i F-Link (ASIsafe Solution PROFIsafe)
- Simple system structure thanks to standardized AS-Interface technique
- Safety-related and standard data on the same bus
- Existing systems can be expanded quickly and easily
- Optimum integration in TIA (Safety Diagnostics) and Safety Integrated
- Safe signals can be combined in groups
- Inclusion of the safety signals in the plant diagnostics, also on existing HMI panels
- Approved to Category 4 according to EN 954-1 or PL e according to EN ISO 13849-1 or SIL 3 according to IEC 61508
- ASIsafe is certified by TÜV (Germany), NRTL (USA) and INRS (France)

#### Application

Integrated safety technology in the AS-Interface system is used wherever EMERGENCY-STOP pushbuttons, protective door interlocks, stop Category 0 and 1, two-hand operator controls and light arrays now installed.

#### More information

More information and circuit examples for safety systems with AS-Interface Safety Monitor and DP/AS-i F-Link can be found on the Internet at

<http://support.automation.siemens.com/WW/view/en/24509484>

**Overview**

Safety monitor with screw terminals (removable terminals)

The safety monitor is the centerpiece of ASIsafe Solution local. It enables safety-orientated responding to signals from the ASIsafe (input) slaves on the same AS-i network and has 1 or 2 enabling circuits. A safe application is configured using a PC. Various application-specific operating modes can be selected for this. They include, for example, an EMERGENCY-STOP function, door tumbler and selection of stop Category 0 or Category 1.

To be able to make full use of the AS-Interface diagnostics options, the monitor can also be operated with an AS interface address if required. With the help of the diagnostics module for STEP 7, which is included on the ASIsafe CD, the full diagnostics spectrum can be processed further in the higher-level PLC.

The AS-Interface safety monitor is currently offered in the latest Version 3 (Firmware V3.x) and is available in three expansion levels.

Both basic/expanded expansion levels are available with one or two-channeled configured enabling circuits.

The expanded safety monitor is also available as a version with integrated safe slave which can be used for the control of a safe AS-i output or for safe coupling of a switch signal on another safety monitor or F-Link.

The safety monitor is used in an AS-Interface bus system to monitor protective devices, e. g. protective doors, EMERGENCY-STOP switches, etc.

The safety monitor can be used up to Category 4 according to EN 954-1, to PL e according to EN ISO 13849-1 and to SIL 3 according to IEC 61508.

Note:

*Depending on the choice of safety components used, the complete safety system may also be classified in a lower safety category.*

The safety monitor is mounted on the standard mounting rail. Disassembly from the standard mounting rail is quick and easy and requires no tools. With an additional accessory (push-in lugs), the safety monitor can also be screwed on.

**Application**

The safety monitor acts as a "bus-based safety relay". It provides a user-friendly introduction to safety-orientated communication over fieldbuses thanks to its simple configuration using the graphic PC software ASIMON. The standard infrastructure of the AS-i network (AS-i master under standard PLC, AS-i power supply unit) can still be used without restriction.

The monitor comes in three expansion levels:

- Basic safety monitor with starter set of modules and basic functionality
- Expanded safety monitor with expanded features and functionality
- The expanded safety monitor is also available as a version with integrated safe slave which can be used for the control of a distributed safe AS-i output or for safe coupling of a switch signal on another safety monitor or F-Link.

**Basic safety monitor versus expanded safety monitor**

	Basic	Expanded
Number of monitoring modules	32	48
Number of OR gates (inputs)	2	6
Number of AND gates (inputs)	--	6
Wildcards for monitoring modules	✓	✓
Deactivating of monitoring modules	✓	✓
Fault release	✓	✓
Diagnostics hold	✓	✓
A/B slaves for acknowledgment	✓	✓
Safe time functions	--	✓
"Button" function	--	✓
Debouncing of contacts	--	✓
Filtering out of brief disconnections	--	✓ (as of version 3)
Control of safe AS-i output/safe coupling	--	✓ (in version with integrated safe slave)

✓ Available  
-- Not available

Number of monitoring modules

The number of devices which the safety monitor can process is increased with the expanded safety monitor from 32 to 48. Applications of greater complexity and size can thus be simulated in the safety monitor.

Logic OR operation

At the logic operation level two elements can be linked by OR operations in the basic version and up to six in the expanded version.

Logic AND operation

In addition to the standard AND operation in the main path of an enabling circuit, an AND operation can also be inserted in an OR operation on the expanded safety monitor. More than two elements can be linked in this AND.

# AS-Interface ASIsafe

## AS-Interface safety monitors

### Features of the basic safety monitor

- Wildcards and deactivating of monitoring modules  
Wildcards are available for the configuration. They are integrated in the configuration and diagnostics and can be easily activated if required. User-friendly configuring is thus possible even when system configurations change.
- Fault release:  
If a module detects a fault, the AS-Interface safety monitor goes into fault status. A differentiated fault release (reset) is now possible for this scenario. The fault release can be activated by an AS-Interface standard slave, e. g. a pushbutton, and is effective only on module level. The great advantage of this is that the entire safety monitor is no longer reset but only the module which is locked in the fault.
- Diagnostics hold:  
Disconnections can be "frozen" until an acknowledgment comes through a standard slave. This function provides valuable help in the event of short-time causes of disconnection.
- Also from Version 3 upwards:  
The standard output data bits of safe input slaves can be processed for acknowledgment, fault release and other non-safety-oriented signals.

### Additional features of the expanded safety monitor

The following additional features are provided by only the expanded safety monitor:

- Safe time functions:  
Timers with the following functions are available:
  - ON-delay
  - OFF-delay and
  - Pulse
- "Button" function:  
Additional acknowledgment option for restarting the system using an additional button. The button function can be assigned to any input or output signal of a standard slave through configuration in the ASIMON software.
- Debouncing of contacts:  
For debouncing the contacts it is possible to set a bounce time after which a system restart takes place.
- Also from Version 3 upwards:  
Filtering out of brief single-channel interruptions in the sensor circuit. A tolerance time can be set during which the brief opening of a safety-oriented input contact is ignored in order to increase plant availability.

### Additional features of the expanded safety monitor with integrated safe slave

This new safety monitor type offers the additional features of the expanded safety monitor plus the following features:

- Filtering out of brief single-channel interruptions in the sensor circuit.
- Actuating a safe distributed actuator (safe output module of e. g. safe valves or motor starters) parallel to the 2nd enabling circuit.
- Alternatively: Use as a "safe coupler" between two ASIsafe networks. A safe input signal on network 1 can thus act on an enabling circuit of network 2. A detour via a hard-wired safe input module on network 2 is not required in this case.

### Configuration software ASIMON V3: New features

- Multi-window system
- Creation of the safety logic in graphic function diagram form, with changeover to former tree presentation possible
- No "preprocessing" of the safety logic
- Management of user-specific modules
- Downward compatibility:
  - Existing ASIMON V2 projects can be loaded
  - Can also be used on all former versions of the safety monitor - with the corresponding scope of functions
- Graphic printout of the safety logic
- Easier system start-up:
  - Teaching the code sequences of safe AS-i Slaves step-by-step
  - Manual input of code sequences also possible in addition
  - Selectable number of simulated slaves
- Simpler diagnostics using AS-Interface through assignment of a diagnostics index to the software function block
- Signaling the switching state of the signaling and relay outputs to higher-level PLCs using a simulated AS-Interface slave
- New functions for filtering out brief interruptions and for controlling a safe AS-i output or for safe coupling of two AS-i networks

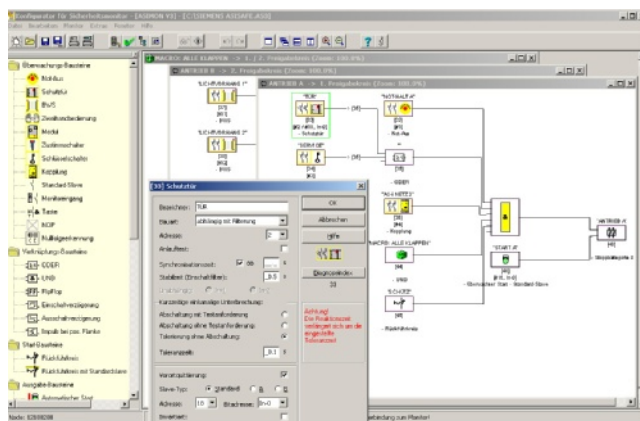

Interface of the configuration software ASIMON V3



## Technical specifications

### 3RK1 105 safety monitor

Rated operational current		
$I_{e}/AC-12$ up to 250 V	A	3
$I_{e}/AC-15$	A	3
• 115 V	A	3
• 230 V	A	3
$I_{e}/DC-12$ up to 24 V	A	3
$I_{e}/DC-13$	A	1
• 24 V	A	0.1
• 115 V	A	0.1
• 230 V	A	0.05
<b>Response time</b>	ms	≤ 40
<b>Achievable performance level acc. to EN ISO 13849-1</b>		PL e
<b>Achievable SIL (or SILCL) acc. to EN 62061</b>		SIL 3
<b>Ambient temperature</b>	°C	0 ... +60
<b>Storage temperature</b>	°C	-40 ... +85

3

## Selection and ordering data

Version	DT	Order No.	
 3RK1 105-1BE04-0CA0	<b>Basic safety monitors</b>		
	Version 3 With screw terminals, removable terminals, width 45 mm		
			<b>Screw terminals</b> 
	• One enabling circuit (monitor type 1)	A	<b>3RK1 105-1AE04-0CA0</b>
	• Two enabling circuits (monitor type 2)	A	<b>3RK1 105-1BE04-0CA0</b>
	<b>Expanded safety monitors</b>		
	Version 3 With screw terminals, removable terminals, width 45 mm		
	• One enabling circuit (monitor type 3)	A	<b>3RK1 105-1AE04-2CA0</b>
	• Two enabling circuits (monitor type 4)	A	<b>3RK1 105-1BE04-2CA0</b>
	<b>Expanded safety monitors with integrated safe slave</b>		
	Version 3 With screw terminals, removable terminals, width 45 mm		
	• Two enabling circuits including control of a safe AS-i out-put/safe coupling (monitor type 6)	A	<b>3RK1 105-1BE04-4CA0</b>
<b>Basic safety monitors</b>			
Version 3 With spring-type terminals, removable terminals, width 45 mm			
		<b>Spring-type terminals</b> 	
• One enabling circuit (monitor type 1)	A	<b>3RK1 105-1AG04-0CA0</b>	
• Two enabling circuits (monitor type 2)	A	<b>3RK1 105-1BG04-0CA0</b>	
<b>Expanded safety monitors</b>			
Version 3 With spring-type terminals, removable terminals, width 45 mm			
• One enabling circuit (monitor type 3)	A	<b>3RK1 105-1AG04-2CA0</b>	
• Two enabling circuits (monitor type 4)	A	<b>3RK1 105-1BG04-2CA0</b>	
<b>Expanded safety monitors with integrated safe slave</b>			
Version 3 With spring-type terminals, removable terminals, width 45 mm			
• Two enabling circuits including control of a safe AS-i output/safe coupling (monitor type 6)	A	<b>3RK1 105-1BG04-4CA0</b>	
<b>Accessories</b>			
<b>ASIsafe CD</b>		<b>3RK1 802-2FB06-0GA1</b>	
Included in the scope of supply:			
• ASIMON V3 configuration software on CD ROM, for PC (Windows XP 32, Windows Vista Business / Ultimate 32, Windows 7 32)			
<b>Cable sets</b>		<b>3RK1 901-5AA00</b>	
Included in the scope of supply:			
• PC configuration cable for communication between PC (serial interface) and safety monitor, length approx. 1.50 m			
• Transfer cable between two safety monitors, length approx. 0.25 m			
<b>USB/serial adapters</b>		<b>3UF7 946-0AA00-0</b>	
To connect a serial PC cable (for connection to serial PC interface/RS 232) to the USB port of a PC, recommended for use in conjunction with AS-i safety monitor for example			
<b>Sealable covers</b>		<b>3RP1 902</b>	
For securing against unauthorized configuration of the safety monitor			
<b>Push-in lugs</b>		<b>3RP1 903</b>	
For screw fixing			



# AS-Interface

## ASIsafe

### AS-Interface safety modules

#### Overview

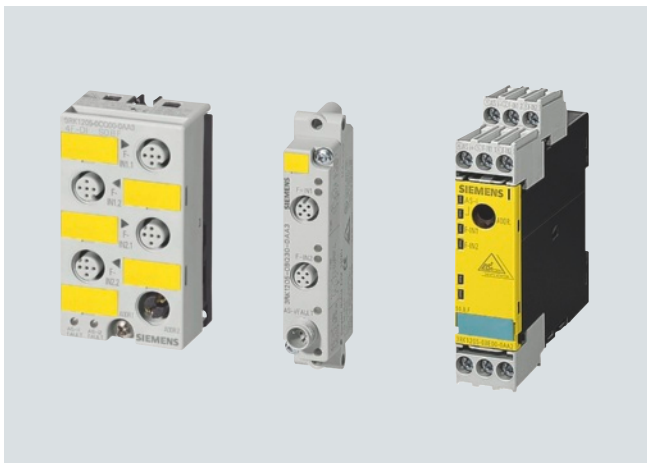

AS-Interface safety modules: K45F (left), K20F (center) and S22.5F (right)



S45F SlimLine module, safe AS-i output

Safety modules for AS-Interface (ASIsafe modules) are available for field use in degree of protection IP67 (K20F and K45F compact modules) and for the control cabinet (S22.5F SlimLine modules) in degree of protection IP20.

A very compact module with an optimum price /performance ratio is thus available for very application.

All modules for the connection of (mechanical) switches and safety sensors with contacts feature crossover monitoring of the connected sensor lead. On versions for the connection of solid-state switches and safety sensors (e. g. light arrays) the crossover monitoring must be performed by the sensor.

Following modules are available for selection:

#### **K20F compact safety modules for operation in the field**

Being only 20 mm wide, the K20F module is particularly well suited for applications where modules need to be arranged in the most confined space. The K20F modules are connected to the AS-Interface with a round cable with M12 cable box instead of with the AS-Interface flat cable. This enables extremely compact installation. The flexibility of the round cable means that it can also be used on moving machine parts without any problems. The K20 modules are also ideal for such applications as their non-encapsulated design makes them particularly light in weight.

#### **K45F compact safety modules for operation in the field**

The platform of the K45F modules covers the following variations:

- Connection of ("mechanical") switches/safety sensors with contacts:
  - K45F 2F-DI: Two safety-oriented inputs in operation up to Category 2 according to EN ISO 13849-1. If Category 4 is required, a two-channel input is available on the module.
  - K45F 2F-DI/2DO: There are also two standard outputs in addition to the safe inputs. Supplied from the yellow AS-i cable
  - K45F 2F-DI/2DO  $U_{aux}$ : same as K45F 2F-DI/2DO, but supplied from the black 24 V DC cable
  - K45F 4F-DI: four safety-oriented inputs in operation up to Category 2, two for Category 4. Extremely compact double slave (uses two full AS-i addresses).
- Connection of solid-state switches/safety sensors (non-contact protective devices, BWS):
  - K45F LS (light sensor): Safe input module for connection of solid-state safety sensors with testing semiconductor outputs (OSSD)  
In particular non-contact protective devices (BWS) such as active, optoelectronic light arrays and light curtains for Type 2 and Type 4 according to IEC/EN 61496. Transmitters as well as receivers are supplied with power from the yellow AS-i cable. Matching sensor cables and optionally a separate transmitter supply module are available as accessories.

#### **S22.5F SlimLine safety modules for operation in control cabinets and local control cabinets**

The S22.5F SlimLine safety module has two safety inputs. The safe connection of signals to ASIsafe networks in the control cabinet is also possible therefore. For operation up to Category 2, both inputs can be assigned separately; if Category 4 is required, a two-channel input is available on the module.

In addition there are two S22.5F module versions which have two standard outputs in addition to the two safety inputs; power is supplied either from only the yellow AS-Interface cable or as auxiliary voltage from the black 24 V DC cable.

#### **S45F SlimLine safety modules with safe outputs for the safe distributed disconnection of actuators**









With the S45F SlimLine safety module, the disconnection signal from e. g. the safety monitor can be used via ASIsafe for distributed safety-oriented disconnection.

For this purpose the module has a two-channel relay output with which an enabling circuit up to safety category 4 and performance level e in conformance with EN SIO 13849-1 or SIL 3 according to EN 62061 / IEC 61508 can be disconnected in fail-safe manner. The response time for the entire system (safety monitor, S45F module, etc.) from the moment of the disconnect request to the actual disconnection is max. 70 ms.

As an additional possibility the module offers normal switching of the output using an AS-i standard output bit.

The module has 3 digital inputs and 2 digital outputs for the additional connection of sensors and actuators which can be used for example for essential monitoring of the feedback circuit of downstream contactors.

## Selection and ordering data





	Version	DT	Order No.	
	<b>K20F compact safety modules</b>			
	I/O type	$U_{aux}$ 24 V		
3RK1 205-0BQ30-0AA3	2 F-DI	--	A <b>3RK1 205-0BQ30-0AA3</b>	
	<b>K45F compact safety modules</b>			
	Modules supplied without mounting plate			
	I/O type	$U_{aux}$ 24 V		
	2 F-DI	--	▶ <b>3RK1 205-0BQ00-0AA3</b>	
	4 F-DI	--	A <b>3RK1 205-0CQ00-0AA3</b>	
	2 F-DI/2 DO	--	B <b>3RK1 405-0BQ20-0AA3</b>	
	2 F-DI/2 DO	✓	B <b>3RK1 405-1BQ20-0AA3</b>	
2 F-DI LS type 2 <sup>1)</sup>	--	A <b>3RK1 205-0BQ21-0AA3</b>		
2 F-DI LS type 4 <sup>2)</sup>	--	A <b>3RK1 205-0BQ24-0AA3</b>		
	<sup>1)</sup> Connection of Siemens light curtain FS 400 3RG7843 (type 2) through socket 1/3			
	<sup>2)</sup> Connection of Siemens light curtain FS 400 3RG7846 (type 4) through socket 1/3, other makes through socket 2/3			
	<b>S22.5F SlimLine safety modules</b>			
	Connection	I/O type	$U_{aux}$ 24 V	
	Screw 	2 F-DI	--	A <b>3RK1 205-0BE00-0AA2</b>
		2 F-DI/2 DO	--	A <b>3RK1 405-0BE00-0AA2</b>
		2 F-DI/2 DO	✓	A <b>3RK1 405-1BE00-0AA2</b>
Spring 	2 F-DI	--	A <b>3RK1 205-0BG00-0AA2</b>	
	2 F-DI/2 DO	--	B <b>3RK1 405-0BG00-0AA2</b>	
	2 F-DI/2 DO	✓	B <b>3RK1 405-1BG00-0AA2</b>	
	<b>S45F SlimLine safety modules</b>			
	Connection	I/O type	$U_{aux}$ 24 V	
	Screw 	1F-RO/3DI/2DO	✓	A <b>3RK1405-1SE15-0AA2</b>
		Spring 	1F-RO/3DI/2DO	✓

# AS-Interface

## ASIsafe

### AS-Interface safety modules

#### Accessories

	Version	DT	Order No.
 3RK1 901-2EA00	<b>K45 mounting plates</b> For mounting K45F <ul style="list-style-type: none"> <li>• For wall mounting</li> <li>• For standard rail mounting</li> </ul>	▶	<b>3RK1 901-2EA00</b>
		▶	<b>3RK1 901-2DA00</b>
	<b>24 V supply modules for K45F LS (light sensor)</b> Optional, for transmitter supply with large protective field widths Modules supplied without mounting plate	A	<b>3RK1 901-1NP00</b>
 3RK1 901-1AA00	<b>Input bridges for K45F</b> <ul style="list-style-type: none"> <li>• Black version</li> <li>• Red version</li> </ul>	A	<b>3RK1 901-1AA00</b>
		D	<b>3RK1 901-1AA01</b>
 3RK1 901-1KA00	<b>AS-Interface sealing caps M12</b> For free M12 sockets	▶	<b>3RK1 901-1KA00</b>
 3RK1 901-1KA01	<b>AS-Interface sealing caps M12, tamper-proof</b> For free M12 sockets	A	<b>3RK1 901-1KA01</b>



### Overview



CP 243-2

The CP 243-2 is the AS-Interface master for the SIMATIC S7-200 and has the following features:

- Connection of up to 62 AS-Interface slaves
- Integrated analog value transmission (Analog Profiles 7.3 and 7.4)
- Supports all AS-Interface master functions according to the extended AS-Interface specification V2.1
- Indication of the operating state and readiness for operation of connected slaves by means of LEDs in the front panel
- Fault indications (e. g. AS-Interface voltage fault, configuration fault) by means of LEDs in the front panel
- Compact enclosure in the design of the SIMATIC S7-200

### Design

The CP 243-2 is connected like an expansion module to the S7-200. It has:

- Two screw terminals for direct connection of the AS-Interface cable
- LEDs in the front panel for indicating the operating state and functional readiness of all connected slaves
- Two pushbuttons for indicating the status information of the slaves, for switching over the operating state and for adopting the existing ACTUAL configuration as the DESIRED configuration.

### Function

The CP 243-2 supports all specified functions of the extended AS-Interface Specification V2.1.

In the process image of the S7-200 the CP 243-2 occupies one digital input byte (status byte), one digital output byte (control byte), and 8 analog input and 8 analog output words. The CP 243-2 thus occupies two (logic) slots. The operating mode of the CP 243-2 can be set with the status byte and the control byte using the user program. Depending on the operating mode the CP 243-2 saves either the digital or analog I/O data of the AS-Interface slaves or diagnostic values in the analog address area of the S7-200, or it enables master calls (e. g. re-addressing of the slaves).

### Configuration

All connected AS-Interface slaves are configured at the press of a button. No further configuration of the CP is required.

### Benefits



- More flexibility and versatility in the use of SIMATIC S7-200 as the result of the distinct increase in the number of digital and analog inputs/outputs available

- Shorter start-up times through simple configuration at the press of a button
- Reduction of standstill and servicing times in the event of a fault thanks to the LED indicators
- Status of the CP
  - Indication of all the slaves connected and their readiness for operation
  - Monitoring of the AS-Interface mains voltage

### Application

The CP 243-2 is the AS-Interface master connection for the 22x CPUs of the SIMATIC S7-200. Through connection to AS-Interface the number of inputs and outputs available for S7-200 is greatly increased (max. 248 DI / 186 DO on the AS-Interface per CP).

Analog values (per CP a maximum of 31 standard analog slaves with up to 4 channels each) also become available on the AS-Interface for the S7-200 thanks to the integrated analog value processing. On the S7-200, up to two CP 243-2 communications processors can be operated simultaneously.

### Selection and ordering data

Version	DT	Screw terminals
		Order No.
	A	<b>6GK7 243-2AX01-0XA0</b>

**CP 243-2 communications processors**  
For connection of the SIMATIC S7-200 to AS-Interface; corresponds to AS-Interface Specification V2.1; dimensions (W x H x D / mm): 71 x 80 x 62 (dimensions without fixing lugs)

6GK7 243-2AX01-0XA0

### More information

The manuals are also available on the Internet at <http://support.automation.siemens.com/WWW/view/en/10805937/133300>

# AS-Interface Masters

## Masters for SIMATIC S7 CP 343-2P, CP 343-2

### Overview



The CP 343-2P / CP 343-2 is the AS-Interface master connection for the SIMATIC S7-300 and the ET 200M.

Through connection to AS-Interface it is possible to access max. 248 DI/248 DO per CP, using 62 A/B slaves with 4DI/4DO each.



With the integrated analog value processing it is easy to transmit analog signals (per CP up to 62 A/B analog slaves with a maximum of two channels each or up to 31 standard analog slaves with a maximum of 4 channels each).

The CP 343-2P is the further development of the CP 343-2 and contains its entire functionality. An existing STEP 7 user program for a CP 343-2 can thus be used without restrictions with a CP 343-2P. It is only in STEP 7 HW-Config that the two modules are configured differently, with the CP 343-2P offering additional options. This is why the CP 343-2P is recommended.

### Selection and ordering data

Version	DT	Order No.
 6GK7 343-2AH11-0XA0 <b>CP 343-2P communications processors</b> For connection of SIMATIC S7-300 and ET 200M to AS-Interface; configuration of the AS-Interface network using the SET key or STEP 7 (V5.2 and higher); without front connector; corresponds to AS-Interface Specification V3.0; dimensions (W x H x D / mm): 40 x 125 x 120	A	<b>6GK7 343-2AH11-0XA0</b>
 6GK7 343-2AH01-0XA0 <b>CP 343-2 communications processors</b> Basic version for connection of SIMATIC S7-300 and ET 200M to AS-Interface Configuration of the AS-i network using the SET key; without front connector; corresponds to AS-Interface Specification V3.0; dimensions (W x H x D / mm): 40 x 125 x 120	A	<b>6GK7 343-2AH01-0XA0</b>

### Accessories

Version	DT	Order No.
<b>Front connectors, 20-pole</b> <ul style="list-style-type: none"> <li>With screw terminals</li> </ul> 	A	<b>6ES7 392-1AJ00-0AA0</b>
<b>Front connectors, 20-pole</b> <ul style="list-style-type: none"> <li>With spring-type terminals</li> </ul> 	A	<b>6ES7 392-1BJ00-0AA0</b>

### More information

The manuals are available on the Internet at <http://support.automation.siemens.com/WW/view/en/14310380/133300>

AS-i Function Block Library for PCS 7 for easy connection of AS-Interface to PCS 7 see Catalog IC 10, chapter 12.

## Overview



DP/AS-i LINK Advanced

PN	DP-M	DP-S	ASi-M		
		●	●		

K10...0185

The DP/AS-i LINK Advanced is a compact router between PROFIBUS (DP Slave) and AS-Interface, with the following features:

- Single and double AS-Interface master (according to AS-Interface Specification V3.0) for connection of 62 AS-Interface slaves or 124 AS-Interface slaves (with a double master)
- Integrated analog value transmission (all analog profiles)
- Integrated ground-fault monitoring for the AS-Interface cable
- User-friendly local diagnostics and start-up by means of a full graphic display and control keys or through a web interface with a standard browser
- Optimum TIA integration using STEP 7
- Integration in non-Siemens engineering tools using the PROFIBUS GSD file
- Vertical integration (standard web interface) through Industrial Ethernet
- Supply voltage from the AS-Interface shaped cable or alternatively with 24 V DC (optional)
- Module exchange without entering the connection parameters (PROFIBUS address etc.) using C-PLUG (optional)

**Design**

- Compact plastic enclosure in degree of protection IP20 for standard rail mounting
- COMBICON plug-in screw terminals
- Compact design:
  - Pixel graphics display in the front panel for detailed indication of the operating state and readiness for operation of all connected AS-Interface slaves
  - 6 pushbuttons for starting up and testing the AS-Interface line directly on the DP/AS-i LINK Advanced
  - LED indication of the operating state of PROFIBUS DP and AS-Interface
  - Integrated Ethernet port (RJ45 socket) for user-friendly start-up, diagnostics and testing of DP/AS-i LINK Advanced through a web interface using a standard browser
- Small mounting depth thanks to recessed plug mounting
- Operation without fans and batteries

**Function**Communication

The DP/AS-i LINK Advanced enables a PROFIBUS DP master to cyclically access the I/O data of all the slaves of a lower-level AS-Interface segment. Also supported are the expanded slave types with higher I/O data volume according to AS-i Specification V3.0.

The DP/AS-i LINK Advanced occupies the following address area:

- As a single master: 32 bytes of input data and 32 bytes of output data in which the I/O data of the connected AS-Interface slaves (standard and A/B slaves) of an AS-i line are stored.
- As a double master occupies twice the number of bytes.

The size of the input/output image can be compressed so that only the actually required I/O address area is occupied in the system of the DP master.

The integrated evaluation of analog signals is just as easy as access to digital values because the analog process data also lie directly in the I/O address area of the CPU.

PROFIBUS DP V1 masters are able in addition to initiate AS-Interface master calls (e. g. to write parameters, change addresses, read diagnostic values) through the acyclic PROFIBUS services.

Using an operating display in AS-i Link it is possible to fully commission the lower-level AS-Interface line.

DP/AS-i LINK Advanced is equipped with an additional Ethernet port which enables use of the integrated web server. The web server can be called up with any standard web browser (e. g. Internet Explorer) without additional software. It enables the PC to present all diagnostic information and to display the set bus configuration and parameters as well as their adaptation where applicable. Firmware updates are also possible using this port.

The optional C-PLUG supports module exchange without entering the connection parameters (IP address etc.), keeping downtimes to a minimum in the event of a fault.

Diagnostics

The following diagnostics is possible using LEDs, the display and control keys, web interface or STEP 7:

- Operating state of the DP/AS-i LINK Advanced
- Status of the link as a PROFIBUS DP slave
- Diagnostics of the AS-Interface network
- Message frame statistics
- Standard diagnostics pages in the web interface for fast diagnostics access through Ethernet using a standard browser

Configuration

DP/AS-i LINK Advanced can be configured either by means of STEP 7 version V5.4 and higher or simply by adopting the AS-Interface actual configuration on the display.

With STEP 7 configuring the AS-Interface configuration can be uploaded in STEP 7 V5.4 and higher. User-friendly configuring of Siemens AS-i slaves in HW-Config is also possible in this case (slave selection dialog).

Alternatively, DP/AS-i LINK Advanced can be integrated by means of the PROFIBUS GSD file in the engineering tool (e. g. for STEP 7 V5.4 and lower or for non-Siemens engineering tools).

# AS-Interface Routers

## DP/AS-i LINK Advanced

### Benefits



- Short start-up times through simple configuration at the press of a button and testing of the AS-Interface line using the display or web interface
- Reduction of standstill and servicing times in the event of a slave failure thanks to user-friendly diagnostics using the display or web interface and through simple module exchange with the help of the C-PLUG exchange medium

- Reduction of installation costs because the power supply comes completely from the AS-Interface cable, making an additional power supply superfluous
- Reduced amount of engineering work thanks to user-friendly configuration of Siemens slaves using the slave catalog in HW-Config (STEP 7)
- Costs saved by the double AS-Interface master when large volumes of project data are involved

### Application

The DP/AS-i LINK Advanced is a PROFIBUS DP-V1 slave (according to EN 50170) and an AS-Interface master (based on AS-Interface Specification V3.0 according to EN 50295). It enables transparent data access to AS-Interface from PROFIBUS DP.

#### Exchanging data with the PROFIBUS DP master

PROFIBUS DP masters (DP-V0) can exchange I/O data with AS-Interface in cyclic mode. PROFIBUS DP masters with acyclic services (DP-V1) are able in addition to initiate AS-Interface master calls (e. g. reading/writing the AS-i configuration during normal operation). As such, the DP/AS-i LINK Advanced is particularly well suited for a decentral construction and for connection of a lower-level AS-Interface network.

#### Single masters

For applications with typical volumes of project data it is sufficient to use the DP/AS-i LINK Advanced in its version as an AS-Interface single master. The single master can operate up to 248 DI/248 DO, using 62 A/B slaves with 4DI/4DO each.

#### Double masters

For applications with large volumes of project data the DP/AS-i LINK Advanced in its version as an AS-Interface double master is used. In this case, twice the volume of project data can be used on two AS-Interface lines running independently of each other. The double master can operate up to 496 DI/496 DO, using 2 AS-i networks with 62 A/B slaves each with 4DI/4DO each.

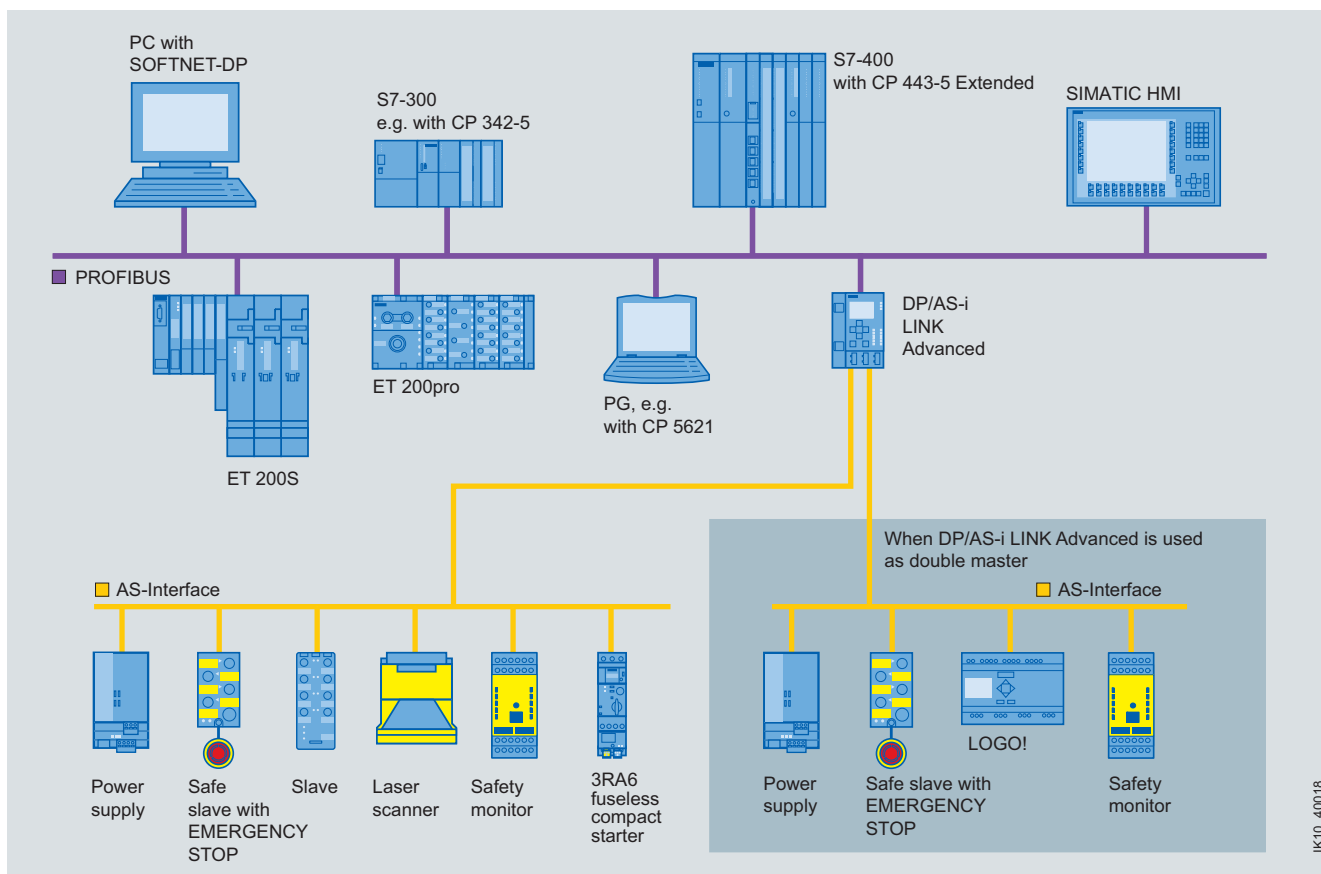

3



Integration of AS-Interface on PROFIBUS through DP/AS-i LINK Advanced as single/double master

IK10\_40018

## Selection and ordering data

Version	DT	Combicon connection 	Order No.
 <p><b>DP/AS-i LINK Advanced</b> Router between PROFIBUS DP and AS-Interface; Degree of protection IP20; including COMBICON plug-in screw terminals for connection of an AS-Interface cable (two AS-Interface cables for double masters) and the optional 24 V supply; corresponds to AS-Interface Specification 3.0; dimensions (W x H x D / mm): 90 x 132 x 88.5</p>	• Single master with display	A	<b>6GK1 415-2BA10</b>
	• Double master with display	A	<b>6GK1 415-2BA20</b>
<b>Accessories</b>			
<b>C-PLUG</b>	A		<b>6GK1 900-0AB00</b>
Exchange medium for the simple exchange of devices in the event of a fault; for accommodating configuration and application data; can be used in SIMATIC NET products with a C-PLUG slot			
<b>PROFIBUS FC Standard Cable GP</b>	A		<b>6XV1 830-0EH10</b>
FastConnect standard type with special design for fast installation, 2-core, shielded			
<b>PROFIBUS FastConnect RS485 bus connectors with angled cable feeder (35°)</b>			
With insulation displacement connection the max. transmission rate is 12 Mbit/s Activatable terminating resistor is integrated			
• Without PG connection socket	A		<b>6ES7 972-0BA60-0XA0</b>
• With PG connection socket	A		<b>6ES7 972-0BB60-0XA0</b>
<b>PROFIBUS FastConnect Stripping Tool</b>	A		<b>6GK1 905-6AA00</b>
Preset stripping tool for speedy stripping of PROFIBUS FastConnect bus cables			
<b>IE FC RJ45 Plug 90</b>			
RJ45 plug-in connector for Industrial Ethernet, with robust metal enclosure and integrated cutting and clamping contacts for connection of Industrial Ethernet FC installation cables; with 90° cable feeder			
• 1 pack = 1 unit	A		<b>6GK1 901-1BB20-2AA0</b>
• 1 pack = 10 units	A		<b>6GK1 901-1BB20-2AB0</b>
• 1 pack = 50 units	A		<b>6GK1 901-1BB20-2AE0</b>

## More information

The manuals are available on the Internet at  
<http://support.automation.siemens.com/WW/view/en/28602701/133300>

# AS-Interface

## Routers

### DP/AS-Interface Link 20E

#### Overview



DP/AS-Interface Link 20E

PN	DP-M	DP-S	ASi-M		
		●	●		

DP/AS-Interface Link 20E connects PROFIBUS DP to AS-Interface and has the following features.

- PROFIBUS DP slave and AS-Interface master
- Up to 62 AS-Interface slaves, each with 4 digital inputs and 4 digital outputs as well as analog slaves can be connected
- Integrated analog value transmission (all analog profiles)
- Supports all AS-Interface master functions according to the AS-Interface Specification V3.0
- Supply from AS-Interface cable; hence no additional power supply required
- Supports the uploading of the AS-Interface configuration in STEP 7 V5.2 and higher

#### Design

- Compact plastic enclosure in degree of protection IP20 for standard rail mounting
- LEDs in the front panel for indicating the operating state and functional readiness of all connected slaves
- Setting option for PROFIBUS DP address by pressing a button
- LED indication of the PROFIBUS DP slave address, DP bus faults and diagnostics
- Two pushbuttons for switching over the operating state and for adopting the existing ACTUAL configuration as the DESIRED configuration

#### Function

##### Communication

DP/AS-Interface Link 20E enables a DP master to access all the slaves of an AS-Interface network.

DP/AS-Interface Link 20E occupies as standard 32 bytes of input data and 32 bytes of output data in which the digital I/O data of the connected AS-Interface slaves (standard and A/B slaves) of an AS-i line are stored.

The size of the input/output image can be compressed so that only the actually required I/O address area is occupied in the system of the DP master.

The analog I/O data can be accessed with the S7 system functions for read/write data record.

##### Configuration

DP/AS-Interface Link 20E can be configured either by means of STEP 7 version V5.1 SP2 and higher or simply by adopting the AS-Interface actual configuration using the SET pushbutton on the front panel.

With STEP 7 configuring the AS-Interface configuration can be uploaded in STEP 7 V5.2 and higher.

User-friendly configuring of Siemens AS-i slaves in HW-Config is also possible in this case (slave selection dialog).

Alternatively, DP/AS-Interface Link 20E can be integrated by means of the PROFIBUS GSD file in the engineering tool (e. g. for STEP 7 V5.1 and lower or for non-Siemens engineering tools).

#### Benefits



- Reduction of installation costs because the power supply comes completely from the AS-Interface cable, making an additional power supply superfluous

- Short start-up times through simple configuration at the press of a button
- Reduction of standstill and servicing times in the event of a slave failure thanks to the LED indicators
- Easy and fast start-up through reading out the AS-Interface configuration

#### Application

The DP/AS-Interface Link 20E is a PROFIBUS DP slave (according to EN 50170) and an AS-Interface master (according to EN 50295). It enables the AS-Interface to be operated on PROFIBUS DP.

DP/AS-Interface Link 20E can operate up to 248 DI / 248 DO when using 62 A/B slaves with 4DI/4DO each.

PROFIBUS DP masters (DP-V0) can exchange I/O data with AS-Interface in cyclic mode.

PROFIBUS DP masters with acyclic services (DP-V1) are able in addition to initiate AS-Interface master calls (e. g. reading/writing the AS-i configuration during normal operation).

## DP/AS-Interface Link 20E

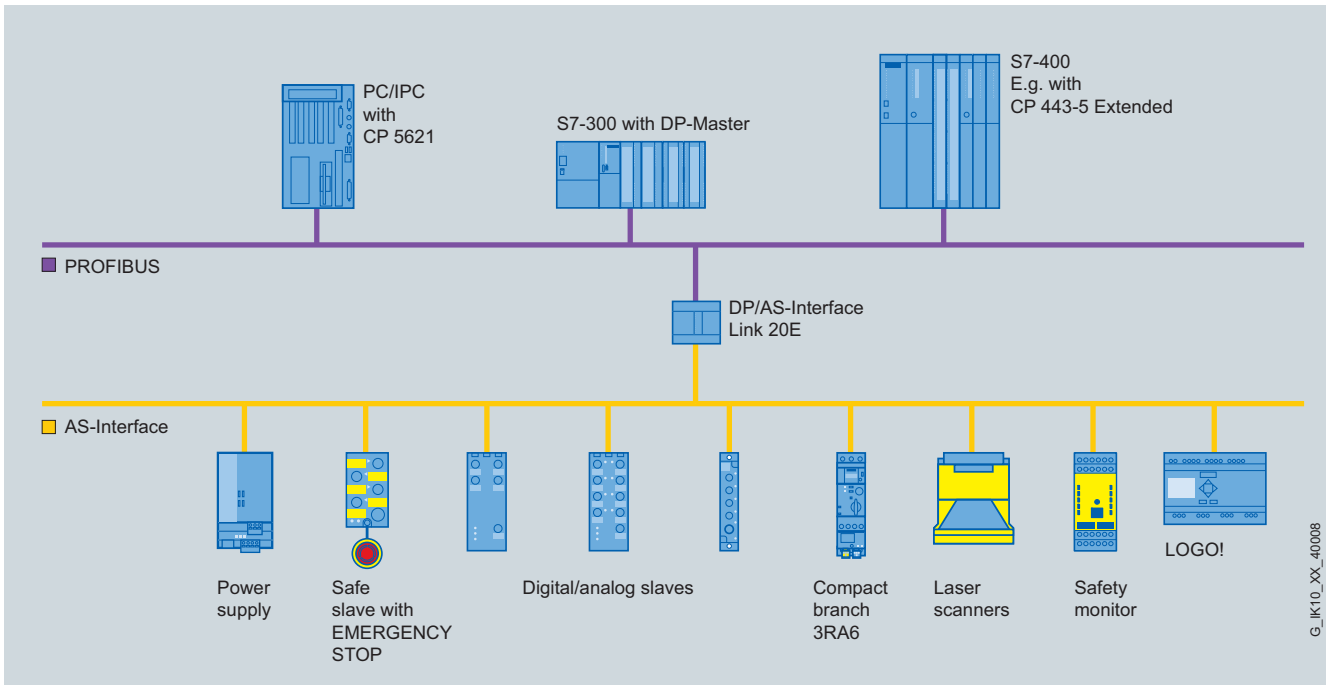

Transition from PROFIBUS DP to AS-Interface using DP/AS-Interface Link 20E

3

### Selection and ordering data

Version	DT	Screw terminals
		Order No.
 <p><b>DP/AS-Interface Link 20E</b> Router between PROFIBUS DP and AS-Interface in degree of protection IP20; including screw terminals for connection of the AS-Interface cable; corresponds to AS-Interface Specification V3.0; dimensions (W x H x D / mm): 90 x 80 x 60 (dimensions without fixing lugs)</p>	A	<b>6GK1 415-2AA10</b>
	<b>Accessories</b>	
<p><b>PROFIBUS FC Standard Cable GP</b> FastConnect standard type with special design for fast installation, 2-core, shielded</p>	A	<b>6XV1 830-0EH10</b>
<p><b>PROFIBUS FastConnect RS485 bus connectors with 90° cable feeder</b> With insulation displacement connection the max. transmission rate is 12 Mbit/s Activatable terminating resistor is integrated</p> <ul style="list-style-type: none"> <li>Without PG connection socket</li> </ul>	A	<b>6ES7 972-0BA52-0XA0</b>
<ul style="list-style-type: none"> <li>With PG connection socket</li> </ul>	A	<b>6ES7 972-0BB52-0XA0</b>
<p><b>PROFIBUS FastConnect RS485 bus connectors with angled cable feeder (35°)</b> With insulation displacement connection the max. transmission rate is 12 Mbit/s Activatable terminating resistor is integrated</p> <ul style="list-style-type: none"> <li>Without PG connection socket</li> </ul>	A	<b>6ES7 972-0BA60-0XA0</b>
<ul style="list-style-type: none"> <li>With PG connection socket</li> </ul>	A	<b>6ES7 972-0BB60-0XA0</b>
<p><b>PROFIBUS FastConnect Stripping Tool</b> Preset stripping tool for speedy stripping of PROFIBUS FastConnect bus cables</p>	A	<b>6GK1 905-6AA00</b>

### More information

The manuals are also available on the Internet at <http://support.automation.siemens.com/WWW/view/en/28602858/133300>

# AS-Interface

## Routers

### DP/AS-i F-Link

#### Overview



DP/AS-i F-Link

PN	DP-M	DP-S	ASi-M		
		●	●		

The DP/AS-i F-Link is a compact, safety-oriented router between PROFIBUS (DP Slave) and AS-Interface, with the following features:

- Monitoring the inputs of safety-oriented digital AS-i slaves (ASIsafe slaves) and forwarding of data through PROFIsafe. No additional safety-oriented components required for the AS-Interface (e. g. safety monitor)
- Connection of up to 62 AS-Interface slaves
- Supports all AS-Interface master functions according to the AS-Interface Specification V3.0
- Typically easy transmission of non-safety-oriented input/output data of all AS-i slaves
- Integrated analog value transmission (all analog profiles)
- Direct integration in PROFIBUS networks.  
Optional integration in PROFINET environments through PROFINET/PROFIBUS gateway (IE/PB Link PN IO) or through SIMATIC S7 315/317/319 F PN/DP or S7-416F-3 PN/DP
- Connection to ET 200S with IM-F-CPU using DP master module is possible
- Optimum TIA integration in STEP 7 using Object Manager, integration in non-Siemens engineering tools using PROFIBUS GSD file
- Local diagnostics using LEDs and display with control keys

#### Design

- Rugged, slim plastic enclosure, degree of protection IP20, for standard rail mounting or wall mounting (with adapter)
- Compact design:
  - LEDs in the front panel for indicating the operating state and functional readiness of all connected slaves
  - 2 buttons on the front for start-up and call up of diagnostics information
  - 4 LEDs for indication of the operating state of the device, of PROFIBUS DP and the AS-Interface network
  - Front PROFIBUS DP connection with sub D connector
  - Removable terminal blocks for connection of AS-i +/- and supply voltage (over 24 V DC PELV power supply unit)
  - Narrow width (45 mm)
- Operation without fans and batteries
- Fast device replacement in the event of a fault

#### Function

##### Communication principle

The PROFIBUS DP master or the safe control communicates with the AS-Interface slaves over the DP/AS-i F-Link. The AS-Interface process data are mapped in different data areas for non-safety-oriented input and output data and safety-oriented input data.

##### Diagnostics

Extensive diagnostics is possible using the four LEDs, display and control keys or SIMATIC S7. Further details can be found in the manual.

##### Configuration

The DP/AS-i F-Link can be configured by means of STEP 7 Version V5.4 SP1 and higher. In particular the user-friendly parameterizing of Siemens AS-Interface slaves using the slave selection dialog is possible. Uploading the ACTUAL configuration of an already configured AS-Interface network is also supported. Alternatively, DP/AS-i F-Link can be integrated in the engineering tool using the PROFIBUS GSD file. As a startup aid the actual configuration for activating the AS-Interface slaves can also be adopted directly on the device.

##### Programming

In contrast to the AS-Interface safety monitor, DP/AS-i F-Link is a pure gateway, which does not run through its own safety logic. Programming of the safety function is implemented at the level of the higher-level fail-safe PLC, e. g.:

- With Distributed Safety, Version V5.4 SP1 or higher for SIMATIC S7-300F/416F
- With the SAFETY INTEGRATED "SI-Basic" or "SI-COMFORT NCU" Software for SINUMERIK 840D pl/sl

The safety and standard range can access the digital and analog I/O data of the connected AS-Interface slaves directly through the I/O address area of the CPU.

#### Benefits

**get** Designed for Industry

- Gaps in (bus-based) safety technology closed: safety-oriented signals (EMERGENCY-STOP, door tumbler, light curtains etc.) collected with AS-i and transferred to higher-level F-PLC. This enables:
  - Quick installation, easy commissioning: Use of AS-i virtues in the field now fully consistent for Safety Integrated
  - Cost-effective solution as ASIsafe is ideally suited for the collection of "fewer but more distributed fail-safe bits".

- Price advantage: As a fully fledged AS-i master according to Specification V3.0, more input and outputs can be used, e. g.:
  - Up to 248 DI / 248 DO when using 62 A/B slaves with 4DI/4DO each
  - Up to 62 digital or analog slaves
- Investment protection:
  - Connection to PROFIBUS networks, such as DP/AS-i Link Advanced or DP/AS-interface Link 20E
  - Downward compatibility to AS-Interface specification V2
  - Open for modern automation concepts with AS-i
- Teaching the code sequences of ASIsafe slaves is possible at the press of a button



- Reduced amount of engineering work thanks to user-friendly configuration of all AS-i slaves from Siemens using the slave selection dialog in HW-Config (STEP 7), including setting the F-parameter of the ASIsafe slaves modeled on PROFIsafe slaves
- Cost-savings thanks to programming of the safety logic with the familiar, powerful commands of the distributed safety packages from the fail-safe SIMATIC PLC in F-FUP or F-FOP, incl. TUV-certified function blocks for typical safety applications
- Use in machine-tools under SINUMERIK 840 D (pl/sl) possible
- Reduction of standstill and servicing times in the event of a slave failure thanks to user-friendly diagnostics using the display and through simple module exchange (only a few settings by control keys are required, without use of the configuring tool)

## Application

### Links between PROFIsafe and ASIsafe

The DP/AS-i F-Link is a PROFIBUS DP-V1 slave (according to EN 50170) and an AS-Interface master (based on AS-Interface Specification V3.0 according to EN 50295). It enables transparent data access to AS-Interface from PROFIBUS DP. The DP/AS-i F-Link is also the only AS-i master with which safety-oriented input data can be passed from ASIsafe slaves via the PROFIsafe protocol to a fail-safe CPU with PROFIBUS DP master. No additional safety cabling or monitoring is required (in particular no AS-Interface safety monitor). The transmission of binary values or analog values is possible depending on the slave type. All slaves according to AS-Interface Specification V2.0, V2.1 or V3.0 can be used as AS-i slaves.

PROFIBUS DP masters according to DP-V0 or DP-V1 can exchange I/O data with lower-level AS-i slaves in cyclic mode. PROFIBUS DP masters with acyclic services according to DP-V1 are able in addition to initiate AS-i command calls (e. g. reading/writing the AS-i configuration during normal operation). In

addition to digital I/O data, analog data can also be saved permanently in the cyclic periphery of a fail-safe S7-300/S7-416 F-CPU.

In configuring mode the DP/AS-i F-Link reads in the configuration data of the peripherals on the AS-Interface. Slave addresses can be set using the display and the control keys, and the code sequences of safe AS-i slaves can be taught.

During operation, four display LEDs and the display provide detailed diagnostics information, which directly localizes the fault if required. Using the PLC user program it is possible to read out diagnostics data records and make them available to a higher-level operating and monitoring system (e. g. WinCC Flexible or TRANSLINE HMI).

### Network connectivity

The DP/AS-i F-Link can be used in PROFIBUS and PROFINET networks as follows:

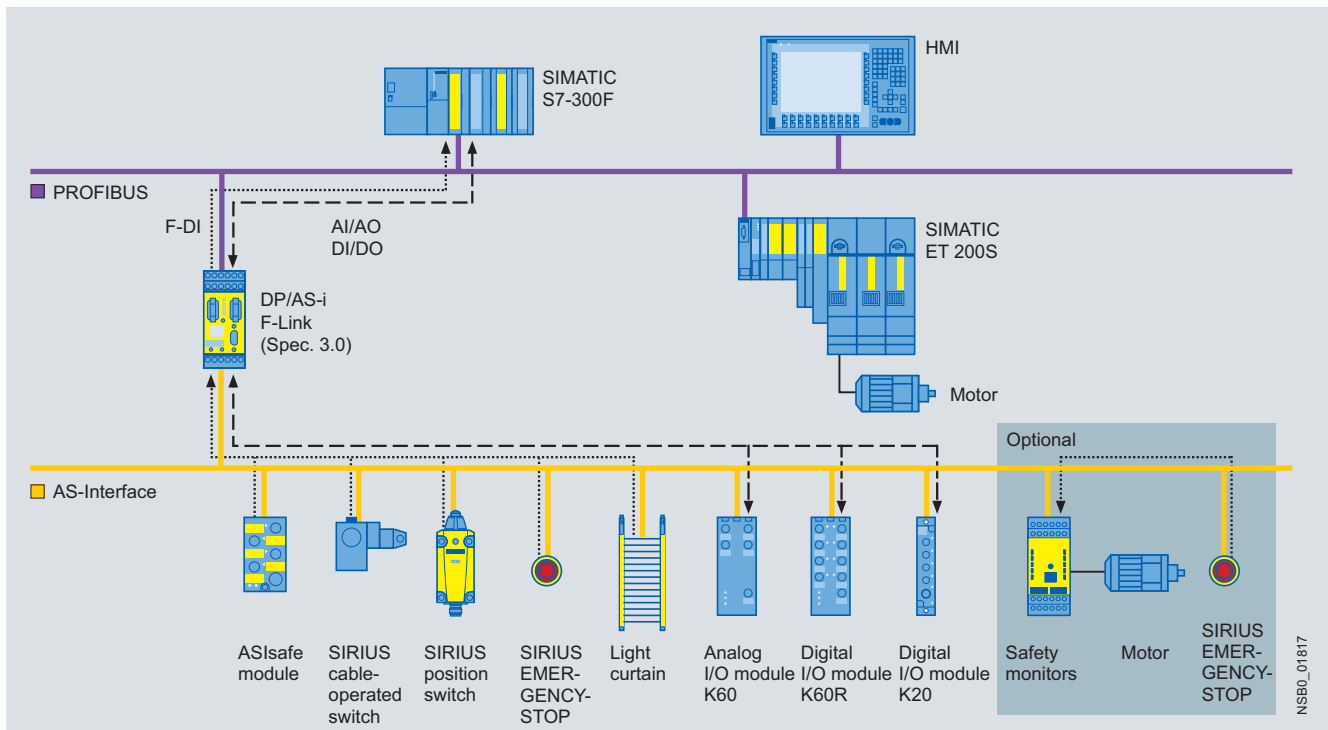

Integration in PROFIBUS networks under SIMATIC F PLC

# AS-Interface Routers

## DP/AS-i F-Link

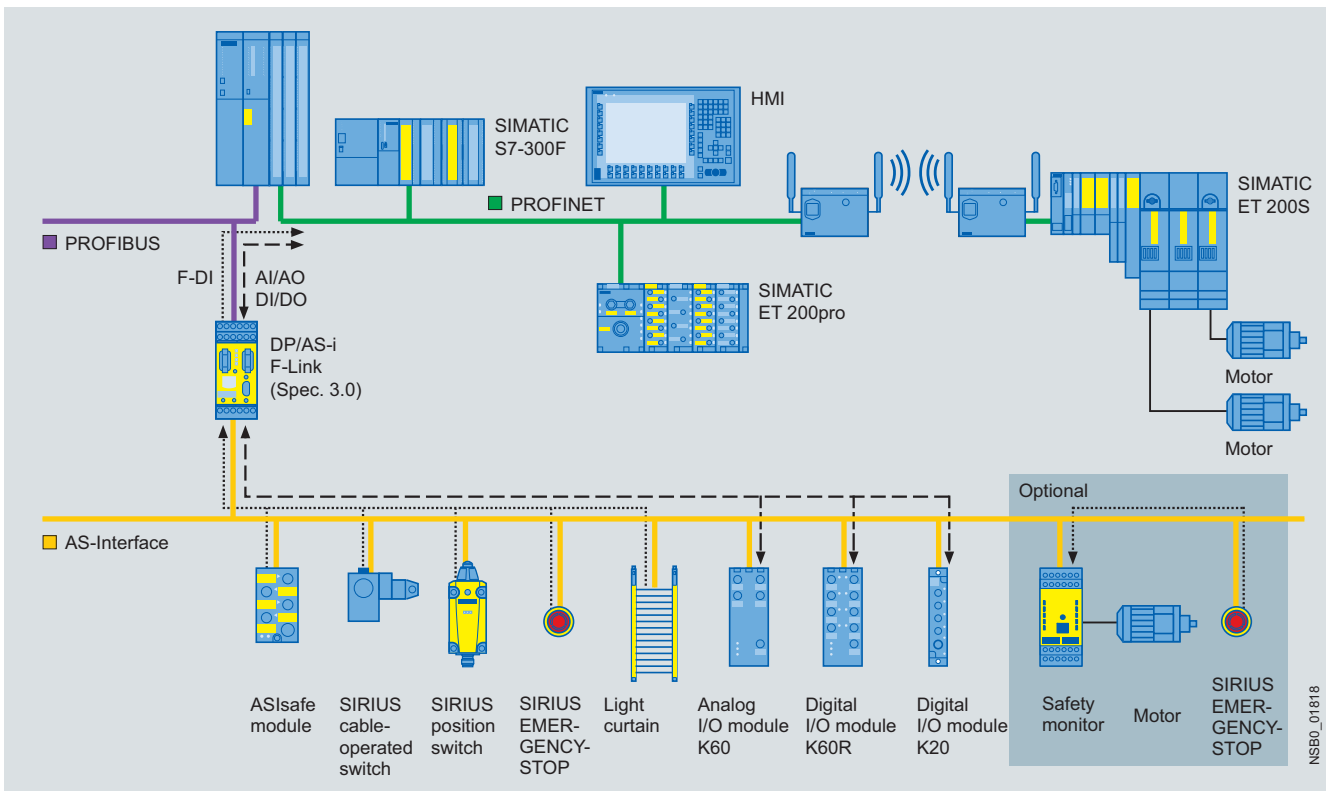

Integration in PROFINET networks under SIMATIC F PLC (alternatively can also be integrated through IE/PB Link)

Further network connectivity options:

- Integration in PROFINET networks under SIMATIC F PLC through IE/PB Link
- Integration in SINUMERIK Power Line and Solution Line
- Integration under non-Siemens fail-safe control systems using PROFIBUS GSD file, available on the Internet at <http://support.automation.siemens.com/WW/view/en/113250>

### Selection and ordering data

Version	DT	Order No.
 <p><b>DP/AS-i F-Link</b> Router between PROFIBUS DP and AS-Interface for safety-oriented data transmission from ASIsafe to PROFIBUS DP – PROFIsafe in degree of protection IP20; corresponds to AS-Interface Specification V3.0; dimensions (W x H x D / mm): 45 x 104 x 120</p>	⊕	A <b>3RK3 141-1CD10</b>
	⊖	A <b>3RK3 141-2CD10</b>

### More information

More accessories for the PROFIBUS connection can be found on [page 3/183](#).

The DP/AS-i F-Link manual is available on the Internet at <http://support.automation.siemens.com/WW/view/en/24196041>

Circuit examples for safety systems with DP/AS-i F-Link are available on the Internet at <http://support.automation.siemens.com/WW/view/en/24509484>

The F-Link Object Manager must be installed for configuring HW-Config (STEP 7). The Object Manager can be downloaded free of charge from the Internet at <http://support.automation.siemens.com/WW/view/en/24724923>

## Overview



IE/AS-i LINK PN IO

PN	DP-M	DP-S	ASi-M		
●			●		

The IE/AS-i LINK PN IO is a compact router between PROFINET/Industrial Ethernet (PROFINET IO Device) and AS-Interface, with the following features:

- Single and double AS-Interface master (according to AS-Interface Specification V3.0) for connection of 62 AS-Interface slaves or 124 AS-Interface slaves (with a double master)
- Integrated analog value transmission (all analog profiles)
- Integrated ground-fault monitoring for the AS-Interface cable
- User-friendly local diagnostics and start-up by means of a full graphic display and control keys or through a web interface with a standard browser
- Optimum TIA integration using STEP 7
- Integration in non-Siemens engineering tools using the PROFINET GSD file
- Vertical integration (standard web interface) through Industrial Ethernet
- Supply voltage from the AS-Interface cable or alternatively with 24 V DC
- Module exchange without entering the connection parameters (IP address etc) using C-PLUG (optional)
- Costs saved by the double AS-Interface master when large volumes of project data are involved

## Design

- Compact plastic enclosure in degree of protection IP20 for standard rail mounting
- COMBICON plug-in screw terminals
- Compact design:
  - Pixel graphics display in the front panel for detailed indication of the operating state and readiness for operation of all connected AS-Interface slaves
  - Six pushbuttons for starting up and testing the AS-Interface line directly on the IE/AS-i LINK PN IO
  - LED indication of the operating state of PROFINET IO and AS-Interface
  - Integrated 2-port switch (RJ45 socket) for connection to Industrial Ethernet supports the line topology with an external switch
- Small mounting depth thanks to recessed plug mounting
- Operation without fans and batteries

## Function

### Communication

The IE/AS-i LINK PN IO enables a PROFINET IO controller to cyclically access the I/O data of all the slaves of a lower-level AS-Interface segment. Also supported are the expanded slave types with higher I/O data volume according to AS-i Specification V3.0.

The IE/AS-i LINK PN IO occupies the following address area:

- As a single master or IO controller with full expansion: 62 bytes of input data and 62 bytes of output data in which the I/O data of the connected AS-Interface slaves (standard and A/B slaves) of an AS-i line are stored.
- As a double master occupies twice the number of bytes.

The size of the input/output image can be compressed so that only the actually required I/O address area is occupied in the system of the DP master.

The integrated evaluation of analog signals is just as easy as access to digital values because the analog process data also lie directly in the I/O address area of the CPU.

PROFINET IO controllers are able in addition to initiate AS-Interface master calls (e. g. to write parameters, change addresses, read diagnostic values) through the acyclic PROFINET services.

Using an operating display in AS-Interface Link it is possible to fully commission the lower-level AS-i line.

The IE/AS-i LINK PN IO is equipped with two Ethernet ports which are connected by an internal switch. With the Ethernet it is possible in addition to use the integrated web server. The web server can be called up with any standard web browser (e. g. Internet Explorer) without additional software. It enables the PC to present all diagnostic information and to display the set bus configuration and parameters as well as their adaptation where applicable. Firmware updates are also possible using this port.

The optional C-PLUG supports module exchange without entering the connection parameters (IP address etc.), keeping downtimes to a minimum in the event of a fault.

### Diagnostics

The following diagnostics is possible using the display and control keys, web interface or STEP 7:

- Operating state of the E/AS-i LINK PN IO
- Status of the link as a PROFINET IO device
- Diagnostics of the AS-Interface network
- Message frame statistics
- Standard diagnostics pages in the web interface for fast diagnostics access through Ethernet using a standard browser

### Configuration

STEP 7 V5.4 or higher is required for configuring the full functional scope of the IE/AS-i LINK PN IO. With STEP 7 configuring the AS-Interface configuration can be uploaded in STEP 7 V5.4 SP2 and higher.

User-friendly configuring of Siemens AS-i slaves in HW-Config is also possible in this case (slave selection dialog).

Alternatively, E/AS-i LINK PN IO can be integrated by means of the PROFINET GSD file in the engineering tool (e. g. for STEP 7 V5.4 SP2 and lower or for non-Siemens engineering tools).

# AS-Interface Routers

## IE/AS-i LINK PN IO

### Benefits



- Short start-up times through simple configuration at the press of a button and testing of the AS-Interface line using the display or web interface
- Reduction of standstill and servicing times in the event of a slave failure thanks to user-friendly diagnostics using the display or web interface

- Reduction of installation costs because the power supply comes completely from the AS-Interface cable, making an additional power supply superfluous
- Reduced amount of engineering work thanks to user-friendly configuration of Siemens slaves by Drag&Drop in HW-Config (STEP 7)

### Application

The DP/AS-i LINK PN IO is a PROFINET IO device (according to IEC 61158) and an AS-Interface master (based on AS-Interface Specification V3.0 according to EN 50 295). It enables transparent data access to AS-Interface from Industrial Ethernet.

#### Exchanging data with PROFINET IO controllers

PROFINET IO controllers can exchange I/O data with AS-Interface in cyclic mode and can perform AS-i master calls in addition with acyclic services (e. g. reading/writing the AS-i configuration during normal operation). As such, the IE/AS-i LINK PN IO is particularly well suited for a decentral construction and for connection of a lower-level AS-Interface network.

#### Single masters

For applications with typical volumes of project data it is sufficient to use the IE/AS-i LINK PN IO in its version as an AS-i single master. The single master can operate up to 248 DI/248 DO, using 62 A/B slaves with 4DI/4DO each.

#### Double masters

For applications with large volumes of project data the IE/AS-i LINK PN IO in its version as an AS-i double master is used. In this case, twice the volume of project data can be used on two AS-i lines running independently of each other. The double master can operate up to 496 DI/496 DO, using 2 AS-i networks with 62 A/B slaves each with 4DI/4DO each.

3

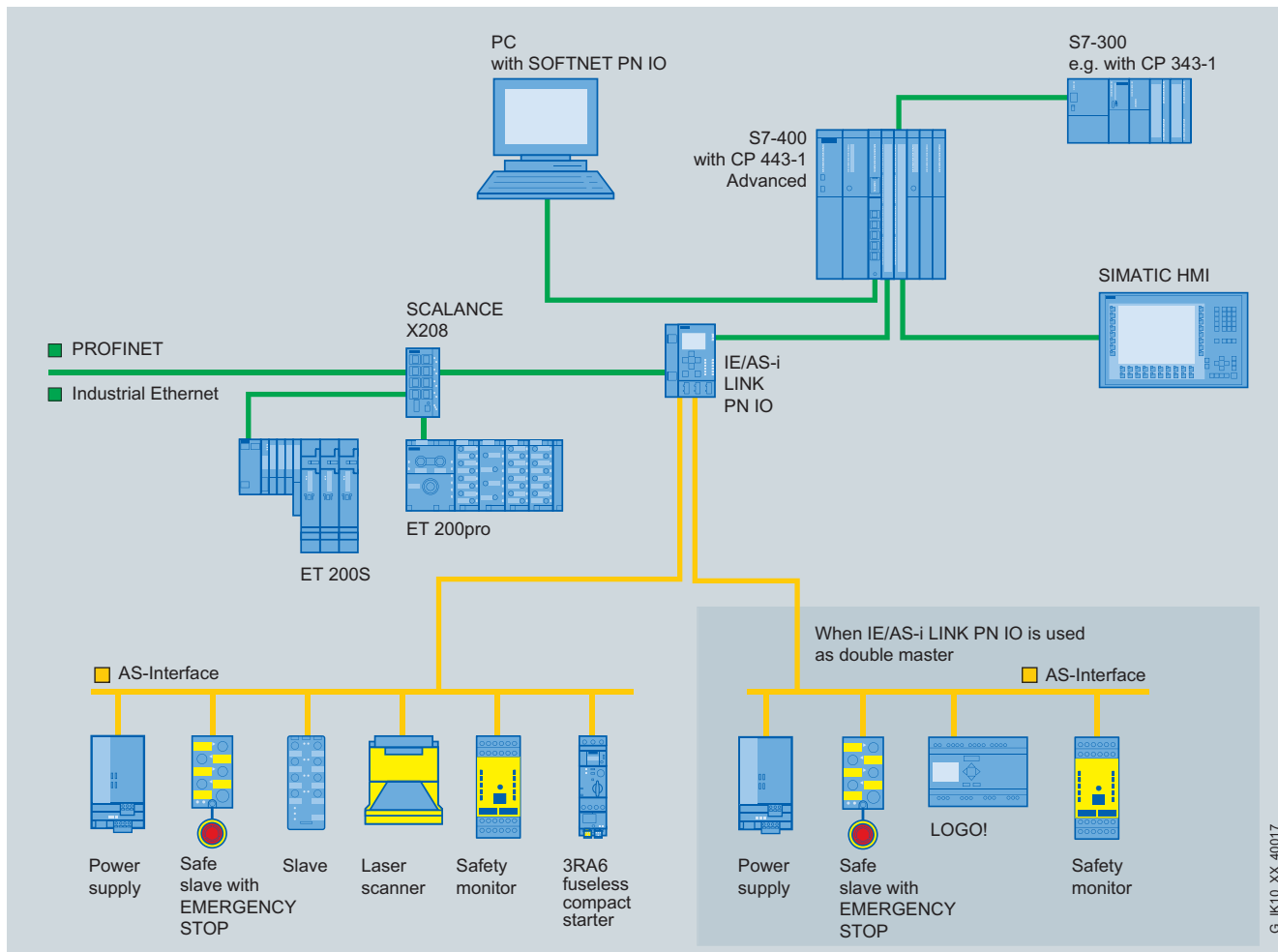

Integration of AS-Interface on PROFINET through IE/AS-i LINK PN IO as single/double master

G\_IK10\_XX\_40017

### Wireless communication

Using an upstream IWLAN client module, e. g. SCALANCE W746-1PRO, an AS-Interface line can be integrated in the PROFINET world by wireless means.

Sample uses are applications which up to now have been performed with fault-prone tow chain or collector wire technology. Maintenance costs are thus reduced.

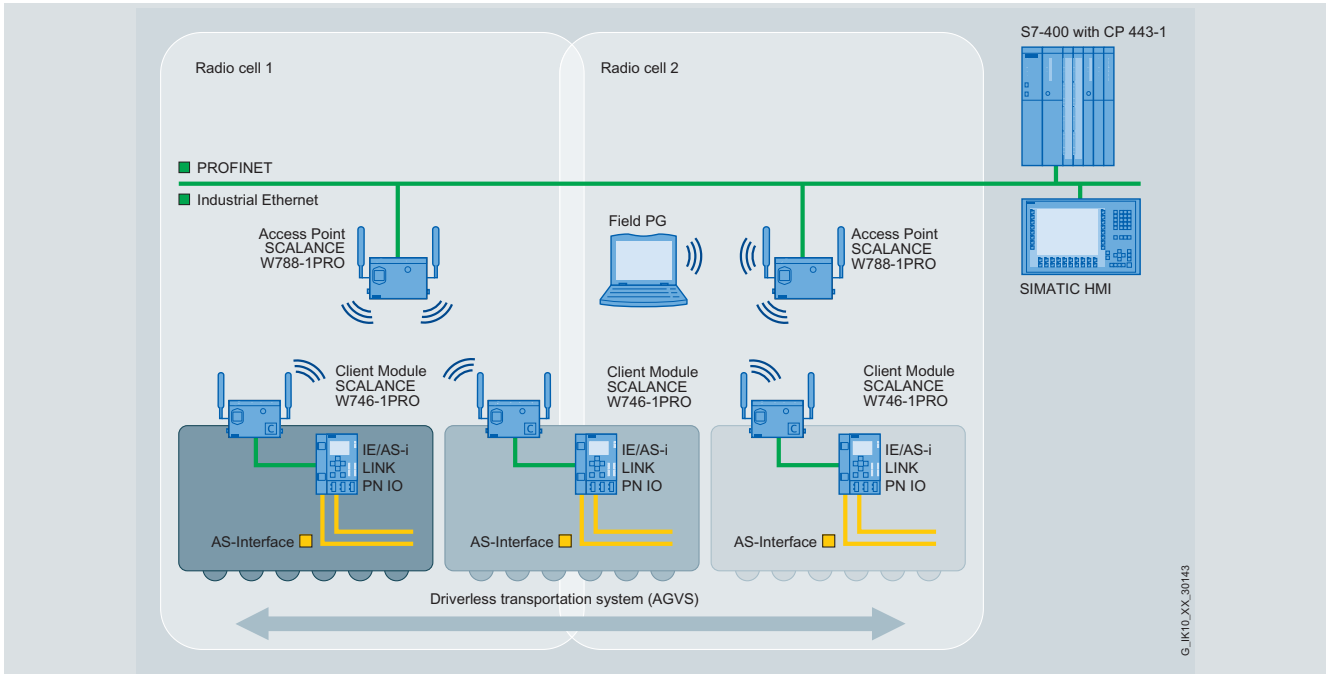

Wireless communication between Industrial Ethernet and AS-Interface components

3

### Selection and ordering data

Version	DT	<b>Combicon connection</b>
		Order No.
<p><b>IE/AS-i LINK PN IO</b></p> <p>Router between PROFINET/Industrial Ethernet and AS-Interface in degree of protection IP20; including COMBICON plug-in screw terminals for connection of an AS-Interface cable (two AS-Interface cables for double masters) and the optional 24 V supply; corresponds to AS-Interface Specification 3.0; dimensions (W x H x D / mm): 90 x 132 x 88.5</p> <ul style="list-style-type: none"> <li>• Single master with display</li> <li>• Double master with display</li> </ul>	<p>A <b>6GK1 411-2AB10</b></p> <p>A <b>6GK1 411-2AB20</b></p>	
	<b>Accessories</b>	
	A	<b>6GK1 900-0AB00</b>
	A	<b>6GK1 901-1BB20-2AA0</b>
	A	<b>6GK1 901-1BB20-2AB0</b>
	A	<b>6GK1 901-1BB20-2AE0</b>

### More information

The manuals are available on the Internet at <http://support.automation.siemens.com/WWW/view/en/29992487/13330>

# SIRIUS 3RK3 modular safety system

## General data

### Overview

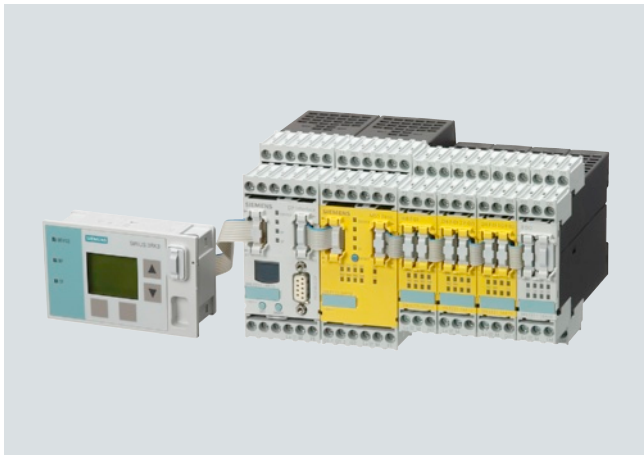

SIRIUS 3RK3 modular safety system

The 3RK3 modular safety system (MSS) is a freely parameterizable modular safety relay. Depending on the type of external connection, safety-orientated applications up to Category 4

according to EN 954-1, Performance Level e according to ISO 13849-1 and SIL3 according to IEC 62061 can be realized.

The modular safety relay permits several safety applications to be interconnected. The safety functions are easily created on the PC using a graphic parameterizing tool. For example, disconnection ranges can be set and other dependencies defined.

With additional safety-oriented expansion modules the system is flexibly adapted to the required safety applications.

The MSS comprises the following system components:

- Central module
- Expansion modules
- Interface modules
- Diagnostics modules
- Parameterization software
- Accessories

The comprehensive error and status diagnostics provides the possibility of finding errors in the system and localizing signals from sensors. Plant downtimes can be reduced as the result.

Optional interface modules send the diagnostics data to higher-level bus systems (e.g. PROFIBUS DP). These data are then available for further processing in the automation system.

### Order No. scheme

Digit of the Order No.	1st - 4th	5th	6th	7th	8th	9th	10th	11th	12th	
	□□□□	□	□	□	-	□	□	□	□	
<b>Modular safety system</b>	<b>3 R K 3</b>									
<b>Device type</b>	□									
<b>Device type</b>	□ □									
<b>Connection type</b>	□									
<b>Communication</b>	□ □ □									
<b>Version</b>	□									
<b>Example</b>	<b>3 R K 3</b>	<b>1</b>	<b>1</b>	<b>1</b>	<b>-</b>	<b>1</b>	<b>A</b>	<b>A</b>	<b>1</b>	<b>0</b>

#### Note:

The Order No. scheme is presented here merely for information purposes and for better understanding of the logic behind the order numbers.

For your orders, please use the order numbers quote in the catalog in the Selection and ordering data.

### Benefits

- More functionality and flexibility through freely configurable safety logic
- For all safety applications thanks to compliance with the highest safety standards (Category 4 according to EN 954-1, Performance Level e according to ISO 13849-1 or SIL3 according to IEC 62061)
- Suitable for use all over the world through compliance with all globally established certifications
- Modular hardware configuration
- Parameterization by means of software instead of wiring
- Removable terminals for greater plant availability

### Communication

The 3RK3 modular safety system can be connected to PROFIBUS through the DP interface and exchange data with higher-level control systems.

The MSS supports among other things:

- Baud rates up to 12 Mbit/s
- Automatic baud rate detection
- Cyclic services (DPV0) and acyclic services (DPV1)
- Exchange of 32-bit cyclic data
- Diagnostics using data record invocations

For MSS with communication function see from page 3/193.

For accessories see page 3/194 onwards.

For more information see Catalog IC 10, chapter 12 "Planning, Configuration and Visualizing for SIRIUS".

## Application

The 3RK3 modular safety system can be used for all safety-oriented requirements in the manufacturing industry and offers the following safety functions:

- **EMERGENCY-STOP:**  
With this function, signals from EMERGENCY-STOP devices with positive-opening contacts are evaluated.
- **Protective door monitoring:**  
Signals from protective doors or protective flaps with positive opening contacts or an NC-NO combination are evaluated.
- **Non-contact protective devices:**  
Signals from e.g. light curtains and laser scanners are evaluated.
- **Switching mats:**  
Signals from switching mats with NC contacts or crossover monitoring are evaluated.
- **Two-hand operator controls:**  
With this function, signals from a two-hand operator control device are evaluated.
- **OK buttons:**  
Signals from OK buttons with NO contact are evaluated.
- **Operating mode selector switches:**  
With this function signals from an operating mode selector switch with NO contacts are evaluated. Up to 5 operating modes can be defined. The operating mode to be implemented can be freely configured in the downstream logic.

- **Logic operation functions:**  
AND, OR, XOR, NAND, NOR, negation (NEG), flip-flop (FF-RS)
- **Counter functions:**
  - The safety relay supports the counting function "counter 0 -> 1". The count value is changed only when there is a positive edge at the count inputs. The current count value can be counted forwards or backwards through one own count input each.
  - The safety relay supports the counting function "For negative edge 1 -> 0". The count value is changed only when there is a negative edge. The current count value can be counted forwards or backwards through one own count input each.
  - The safety relay supports the counting function "For both edges". The count value is changed both when there is a positive edge and when there is a negative edge. The current count value can be counted forwards or backwards through one own count input each.
- **Time functions:**  
ON delay, On delay (trigger), passing make contact, passing make contact (trigger), OFF delay, OFF delay (trigger), clock-pulsing.
- **Start functions:**  
Manual and automatic start
- **Output functions:**  
Standard outputs and fail-safe outputs can be actuated.

## Technical specifications

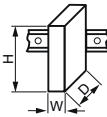
Type		Central modules	Expansion modules						Interface modules	Diagnostics modules
			4/8F-DI	2/4 F-DI 1/2 F-RO	2/4 F-DI 2F-DO	4/8 F-RO	4 F-DO	8 DI		
Dimensions (W x H x D)										
										
• Screw terminals	mm	45 x 111 x 124	22.5 x 111 x 124				45 x 111 x 124	22.5 x 111 x 124	45 x 111 x 124	96 x 60 x 44
• Spring-type terminals	mm	45 x 113 x 124	22.5 x 113 x 124				45 x 113 x 124	22.5 x 113 x 124	45 x 113 x 124	--
<b>Device data</b>										
<b>Shock resistance (sine pulse)</b>	g/ms	15/11								
<b>Touch protection</b> acc. to EN 50274 or EN 60529		IP20								
<b>Permissible mounting position</b>		Vertical mounting surface (+10°/-10°), deviating mounting positions are permitted for reduced ambient temperature								
<b>Minimum distances</b>		For heat dissipation through convection from the devices 25 mm to the ventilation openings (top and bottom)								
<b>Permissible ambient temperature</b>										
• During operation	°C	-20 ... +60								
• Storage and transport	°C	-40 ... +85								
<b>Number of sensor inputs (1-channel)</b>		8	8	4	4	--	--	8	8	--
<b>Number of test outputs</b>		2	2	2	2	--	--	--	--	--
<b>Number of outputs</b>										
• Relay outputs										
- Single channel		--	--	2	--	8	--	--	--	--
- Two-channel		1	--	--	--	--	--	--	--	--
• Solid-state outputs										
- Single channel		--	--	--	--	--	--	--	8	--
- Two-channel		1	--	--	2	--	4	--	--	--
<b>Weight</b>	g	300	160	160	160	400	135	125	160	270
<b>Installation altitude above sea level</b>	m	2000								

# SIRIUS 3RK3 modular safety system

## General data

Type		Expansion modules								Interface modules	Diagnostics modules
		Central modules	4/8F-DI	2/4 F-DI 1/2 F-RO	2/4 F-DI 2F-DO	4/8 F-RO	4 F-DO	8 DI	8 DO		
<b>Environmental data</b>											
<b>EMC interference immunity</b>		IEC 60947-5-1									
<b>Vibrations</b>											
• Frequency	Hz	5 ... 500									
• Amplitude	mm	0.75									
<b>Climatic withstand capability</b>		EN 60068-2-78									
<b>Electrical specifications</b>											
<b>Rated control supply voltage <math>U_s</math></b>	V	24 DC ±15 % <sup>1)</sup>	24 DC ±15 %	24 DC ±15 %	24 DC ±15 %	24 DC ±15 %	24 DC ±15 %	24 DC ±15 %	24 DC ±15 %	24 DC ±15 %	24 DC ±15 % <sup>2)</sup>
According to IEC 61131-2											
<b>Operating range</b>		0.85 ... 1.15 x $U_s$									
<b>Rated insulation voltage <math>U_i</math></b>	V	300	50	300	50	300	50	50	50	50	50
<b>Rated impulse voltage <math>U_{imp}</math></b>	kV	4	500	4	500	4	500	500	500	500	500
<b>Total current input</b>	mA	185	60	85	85	140	8	78	60	--	24
<b>Rated power at <math>U_s</math></b>	W	4.5	1.5	2	2	3	4.8	1.9	1.5	--	0.6
<b>Utilization category</b> according to EN 60947-5-1 (relay outputs)											
• AC15 at 230 V	A	2	--	2	--	3	--	--	--	--	--
• DC13 at 24 V (semiconductor outputs)	A	1	--	1	--	3	--	--	--	--	--
• DC13 at 24 V	A	1.5	--	--	1	--	2	--	0.5	--	--
<b>Mechanical endurance</b> during rated operation		Operating cycles (relay)	10 x 10 <sup>6</sup>	--	10 x 10 <sup>6</sup>	--	10 x 10 <sup>6</sup>	--	--	--	--
<b>Switching frequency z</b> at rated operational current	1/h	1000	--	1000	1000	360	1000	--	1000	--	--
<b>Conventional thermal current <math>I_{th}</math></b>	A	2/1.5	--	1	1	3	2	--	0.5	--	--
<b>Fusing for output contacts</b>											
Fuse links											
LV HRC Type 3NA, DIAZED Type 5SB, NEOZED Type 5SE											
• Operational class gG	A	4	--	4	--	4	--	--	--	--	--
• Operational class quick	A	6	--	6	--	6	--	--	--	--	--
<b>Safety specifications</b>											
<b>Probability of a dangerous failure</b>											
• Per hour (PFH <sub>d</sub> )	1/h	5.14 x 10 <sup>-9</sup>	1.89 x 10 <sup>-9</sup>	3.79 x 10 <sup>-9</sup>	2.7 x 10 <sup>-9</sup>	7.15 x 10 <sup>-9</sup>	3.18 x 10 <sup>-9</sup>	--	--	--	--
• On demand (PFD)	1/h	1.28 x 10 <sup>-5</sup>	4.29 x 10 <sup>-6</sup>	5.85 x 10 <sup>-6</sup>	8.34 x 10 <sup>-6</sup>	4.36 x 10 <sup>-5</sup>	2.2 x 10 <sup>-5</sup>	--	--	--	--
<b>Parameters for cables</b>											
<b>Line resistance</b>	Ω	100	100	100	100	--	--	100	--	--	--
<b>Cable length from terminal to terminal</b>											
With Cu 1.5 mm <sup>2</sup> and 150 nF/km	m	1000	1000	1000	1000	--	--	1000	--	--	--
<b>Conductor capacity</b>	nF	330	330	330	330	--	--	330	--	--	--

<sup>1)</sup> Device current supply through a power supply unit acc. to IEC 60536 protection class (SELV or PELV).

<sup>2)</sup> Via connecting cable to the central module.



Central modules, expansion modules, interface modules, operating and monitoring modules

### Selection and ordering data



3RK3 111-1AA10



3RK3 211-1AA10  
3RK3 221-1AA10  
3RK3 231-1AA10  
3RK3 242-1AA10



3RK3 251-1AA10





3RK3 311-1AA10  
3RK3 321-1AA10



3RK3 511-1BA10



3RK3 611-3AA00

Version	DT	Screw terminals 	DT	Spring-type terminals 
		Order No.		Order No.
<b>Central modules</b>				
<b>3RK3 Basic</b>				
Central module with safety-orientated inputs and outputs • 8 inputs • 1 two-channel relay output • 1 two-channel solid-state output Max. 7 expansion modules can be connected, including 3RK3 931-0AA00 memory module	A	<b>3RK3 111-1AA10</b>	A	<b>3RK3 111-2AA10</b>
<b>Expansion modules</b>				
<b>4/8 F-DI</b>				
Safety-orientated expansion modules • 8 inputs	A	<b>3RK3 211-1AA10</b>	A	<b>3RK3 211-2AA10</b>
<b>2/4 F-DI 1/2 F-RO</b>				
Safety-orientated mixed expansion modules • 4 inputs • 2 single-channel relay outputs	A	<b>3RK3 221-1AA10</b>	A	<b>3RK3 221-2AA10</b>
<b>2/4 F-DI 2F-DO</b>				
Safety-orientated mixed expansion modules • 4 inputs • 2 two-channel solid-state outputs	A	<b>3RK3 231-1AA10</b>	A	<b>3RK3 231-2AA10</b>
<b>4/8 F-RO</b>				
Safety-oriented output modules • 8 relay outputs	A	<b>3RK3 251-1AA10</b>	A	<b>3RK3 251-2AA10</b>
<b>4 F-DO</b>				
Safety-oriented output modules • 4 two-channel solid-state outputs	A	<b>3RK3 242-1AA10</b>	A	<b>3RK3 242-2AA10</b>
<b>8 DI</b>				
Standard input modules • 8 inputs	A	<b>3RK3 321-1AA10</b>	A	<b>3RK3 321-2AA10</b>
<b>8 DO</b>				
Standard output modules • 8 solid-state outputs	A	<b>3RK3 311-1AA10</b>	A	<b>3RK3 311-2AA10</b>
<b>Interface modules</b>				
<b>DP interface</b>				
PROFIBUS DP Interface, 12 Mbit/s, RS 485, 32 bit cyclic data exchange, acyclic exchange of diagnostics data	A	<b>3RK3 511-1BA10</b>	A	<b>3RK3 511-2BA10</b>
<b>Operating and monitoring modules</b>				
<b>Diagnostics modules</b>				
	A	<b>3RK3 611-3AA00</b>	--	







Note:

Connection cable required, see next page.

# SIRIUS 3RK3 modular safety system

## Accessories

### Selection and ordering data

Version	DT	Order No.	
<b>Connection cables (essential accessory)</b>			
 <p>3UF7 932-0AA00-0</p>	For connection of		
	Central module to expansion modules or interface module	Diagnostic module to central modules or interface module	
	✓	✓	• Length 0.025 m (flat) A <b>3UF7 930-0AA00-0</b>
	--	✓	• Length 0.1 m (flat) A <b>3UF7 931-0AA00-0</b>
	--	✓	• Length 0.3 m (flat) A <b>3UF7 935-0AA00-0</b>
	--	✓	• Length 0.5 m (flat) A <b>3UF7 932-0AA00-0</b>
	--	✓	• Length 0.5 m (round) A <b>3UF7 932-0BA00-0</b>
	--	✓	• Length 1.0 m (round) A <b>3UF7 937-0BA00-0</b>
--	✓	• Length 2.5 m (round) A <b>3UF7 933-0BA00-0</b>	
<b>PC cables and adapters</b>			
 <p>3UF7 940-0AA00-0</p>	<b>PC cables for PC/PG communication with 3RK3 modular safety system</b> Through the system interface, for connecting to the serial interface of the PC/PG	A <b>3UF7 940-0AA00-0</b>	
	<b>USB/serial adapters</b> To connect an RS 232 PC cable to the USB port of a PC, recommended for use in conjunction with 3RK3	B <b>3UF7 946-0AA00-0</b>	
<b>Interface covers</b>			
 <p>3UF7 950-0AA00-0</p>	<b>For system interface</b>	A <b>3UF7 950-0AA00-0</b>	
<b>Memory modules</b>			
 <p>3RK3 931-0AA00</p>	<b>For parameterizing the 3RK3 modular safety system without a PC/PG through the system interface</b>	A <b>3RK3 931-0AA00</b>	
<b>Door adapters</b>			
 <p>3UF7 920-0AA00-0</p>	<b>For external connection of the system interface, e.g. outside a control cabinet</b>	A <b>3UF7 920-0AA00-0</b>	
<b>Push-in lugs</b>			
 <p>3RP19 03</p>	<b>For screw fixing</b> E.g. on mounting plate, 2 units required per device • Can be used for 3RK3	▶ <b>3RP19 03</b>	

### Overview

Modular Safety System ES is the engineering software for the configuration, start-up and diagnostics of the 3RK3 modular safety system. The software combines the configuring of the hardware, the programming of the safety functions, and the testing and diagnostics of the safety system.

#### Hardware configuration

The configuration defines the system's hardware layout. It lays down which modules are used in the system: A central module as a safe control system including onboard peripherals, expansion modules with inputs and outputs, an interface module for connecting to PROFIBUS. For better clarity the layout is shown in a graphic presentation. For each module, it is optionally possible to issue an equipment ID which is shown in the logic diagram for identification of the inputs and outputs.

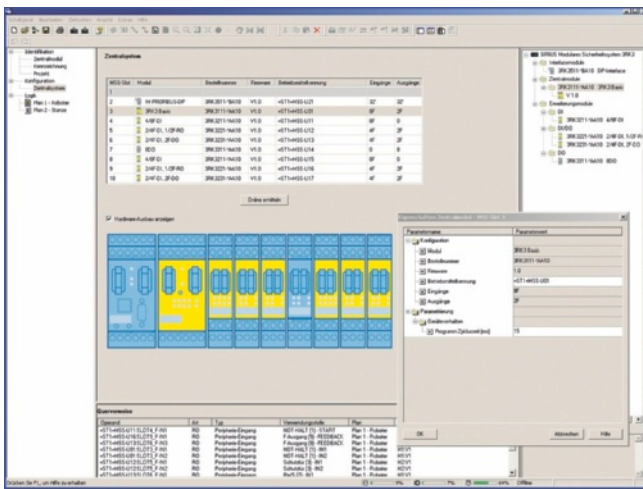

Definition of the hardware layout

The safety logic can be divided into several diagrams in order to enable structured processing of the entire plant. The user can freely position the functions on a quasi infinitely large drawing board, whereby the connecting lines are drawn automatically. If there is not enough space, more pages are automatically added to the diagram in horizontal or vertical direction. Connecting lines extending over several pages are automatically issued with cross-references during print-out. If required in the interest of clarity, the user can divide a connecting line manually into two segments, whereby the mutual reference is marked by reference arrows. For further documentation, freely compilable comment texts can be placed at any point in the diagram. Every point in the logic diagram can be processed with ease by dragging and zooming.

Every project can be saved as a file and be password-protected from unauthorized access.

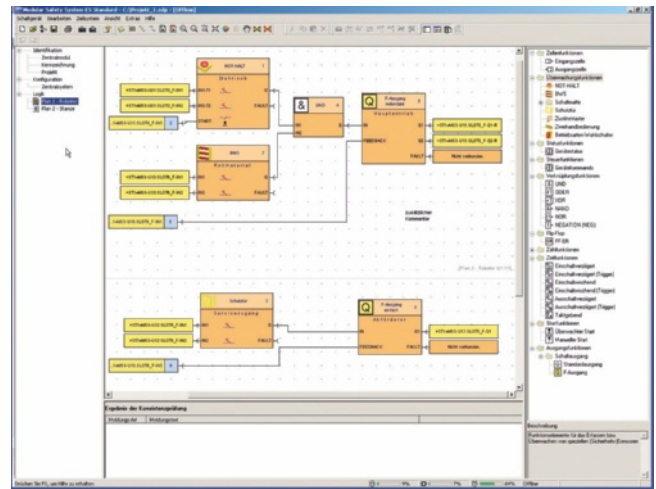

Processing the safety functions with the graphics editor

#### Graphic parameterizing of the safety logic by Drag & Drop

The functionality of the safety logic is laid down with a graphics editor designed for intuitive operation. Safe monitoring functions (EMERGENCY-STOP, non-contact protective devices/light arrays, protective doors, etc.), output functions and logic functions (AND/OR operations, counting function, time functions, etc.), non-safety-orientated input/output functions, device status functions and control functions can be dragged from the extensive functions catalog onto the work interface by Drag&Drop. Depending on the version, each function has several input and output connecting points through which the functions can be interconnected by simple mouse clicks. Double-clicking on a function symbol opens the related features dialog window in which all the parameters can be displayed and configured: Scope of the function's inputs and outputs, configuring the channel type (one-channel/two-channel, NC contact/NO contact), activating the crossover monitoring, defining start options, assigning the hardware inputs and outputs, etc. Of course each function can be issued with an individual name so that e.g. the position of a safety switch in the plant can be documented.

#### User prompting during start-up and maintenance

To start up the 3RK3 modular safety system, the created project file is loaded into the device. This requires the serial interface (COM) of the PC to be connected with a special connection cable to the device. Access to the device can be password-protected.

After the project is loaded, the user switches the device by means of the software from configuring mode to test mode in which the safety functions are tested.

Activating the diagnostics shows the status of the individual functions in the graphic logic diagram by means of different colors and symbols. In addition, the signal status of each input and output can be manually overwritten ("forcing").

If the test is completed successfully, the user releases the configuration and switches the device to protection mode, in which case "forcing" is automatically deactivated.

Service personnel can activate the graphic diagnostics in protection mode as well. The I&M (Identification & Maintenance) data saved in the device facilitate maintenance.

# SIRIUS 3RK3 modular safety system

## Engineering software

### Modular Safety System ES

Modular Safety System ES	Basic	Standard
Access through the local interface on the device	✓	✓
Parameter assignment	✓	✓
Operating	✓	✓
Diagnostics	✓	✓
Test	✓	✓
Integrated graphics editor	✓	✓
Importing/exporting parameters	--	✓
Comparison functions	--	✓
Comfort functions	--	✓
Terminal designator	--	✓
Work on sub-diagrams	--	✓
Standards-conform printout according to EN ISO 7200	✓	✓

✓ Function available

-- Function not available

#### More functions

- The program interface language can be switched during use between German, English and French.
- A context-sensitive help function provides useful assistance with questions concerning the use of the program.
- A consistency check informs clearly about function assignment errors; Checks are carried out automatically when a project is saved and during the configuration test, but they can also be initially manually.
- Lists of symbols and cross-references can be issued output for effective processing of the project file.
- Standards-conform printouts  
The programs of the SIRIUS ES software family make machine documentation far easier. They enable parameterization printouts according to EN ISO 7200. The elements to be printed are easy to select and group as required.

#### System requirements

##### Modular Safety System ES 2008 parameterization, start-up and diagnostics software for the 3RK3 modular safety system

<b>Operating system</b>	Windows XP Professional (Service Pack 2), Windows Vista Ultimate 32/Business 32
<b>Processor</b>	≥ Pentium 800 MHz/≥ 1 GHz (Windows Vista)
<b>RAM</b>	≥ 512 Mbyte/≥ 1 GB (Windows Vista)
<b>Monitor resolution</b>	≥ 1 024 x 768
<b>Free space on hard disk</b>	≥ 280 MB
<b>CD-ROM/DVD drive</b>	Yes (only when installing from CD)
<b>Serial interface (COM)</b>	Yes
<b>PC cables for PC/PG communication</b>	Yes

#### Types of delivery and license

Modular Safety System ES 2008 is available as follows:

- Floating license
  - Package contains the software on CD and a floating license on a USB stick
  - The software can be installed on any number of PCs
  - The floating license enables the software to be used by 1 user; after use, it can be transferred from the one PC to another
  - The CD also contains a trial license for test and evaluation purposes (free use of all program functions on any PC for a period of 14 days).

Following delivery versions are available in addition for Modular Safety System ES 2008:

- Powerpack  
Special pack for switching within the same software version to a more powerful version with more functionality, e.g. Powerpack Modular Safety System ES 2008 for switching from Basic to Standard.
- Software Update Service  
To keep you up to date at all times we offer a special service which supplies you automatically with all service packs and upgrades on CD (floating license not included in delivery)
- License Download  
User-friendly license key download from our Mall (currently only for customers from Germany) as an easy and quick way for you to receive additional licenses for your software.

The software can be downloaded free from the Internet (without floating license) at:

<http://support.automation.siemens.com/WWW/view/en/30320790>

The download file also contains a trial license for test and evaluation purposes, which allows free use of all program functions on any PC for a period of 14 days. A floating license is needed to use the software after the 14 days.

### Selection and ordering data

#### Parameterization, start-up and diagnostics software for the 3RK3 modular safety system

- Runs under WIN XP PROF/  
Windows Vista: Ultimate 32/Business 32
- Without PC cable

Version	DT	Order No.
---------	----	-----------

#### Modular Safety System ES 2008 Basic

##### Floating license for one user

E-SW, software and documentation on CD,  
3 languages (German/English/French),  
communication through system interface

- License key on USB stick, Class A, including CD ▶
- License key download, Class A, no CD ▶

**3ZS1 314-4CC10-0YA5**

**3ZS1 314-4CE10-0YB5**

#### Modular Safety System ES 2008 Standard

##### Floating license for one user

E-SW, software and documentation on CD,  
3 languages (German/English/French),  
communication through system interface

- License key on USB stick, Class A, including CD ▶
- License key download, Class A, no CD ▶

**3ZS1 314-5CC10-0YA5**

**3ZS1 314-5CE10-0YB5**

##### Powerpack

##### For Modular Safety System ES 2008 Basic

Floating license for one user,  
E-SW, software and documentation on CD,  
license key on USB stick, Class A,  
3 languages (German/English/French),  
communication through the system interface

▶ **3ZS1 314-5CC10-0YD5**

##### Software Update Service

For 1 year with automatic extension,  
assuming the current software version is in use,  
E-SW, software and documentation on CD,  
communication through the system interface

▶ **3ZS1 314-5CC10-0YL5**

#### Accessories

##### PC cables for PC/PG communication,

Through the system interface on the device, for connecting to  
the serial interface on the PC/PG

A **3UF7 940-0AA00-0**

##### USB/serial adapters

To connect a serial PC cable  
(for connection to the serial PC interface / RS 232)  
we recommend using 3RK3 modular safety system,  
3RW44 soft starters, ET 200S/ECOFAS/ET 200pro motor  
starters, AS-i safety monitor and AS-i analyzer in conjunction  
with SIMOCODE pro 3UF7

B **3UF7 946-0AA00-0**

# SIRIUS 3TK28 safety relays

## General data

### Overview



SIRIUS 3TK28 safety relay

SIRIUS safety relays are the key modules of a consistent and cost-effective safety chain. Be it EMERGENCY-STOP disconnection, protective door monitoring or the protection of presses or punches – with SIRIUS safety relays every safety application can be implemented to optimum effect in terms of engineering and price.

SIRIUS safety relays provide numerous safety-related functions:

- Monitoring the safety functions of sensors
- Monitoring the sensor leads
- Monitoring the correct operation of the safety relay
- Monitoring actuators for stoppage
- Safety-oriented disconnection when dangers arise

Depending on the version of the device, SIRIUS safety relays satisfy the most stringent requirements (PL e) of ISO 13849-1 and achieve the highest Safety Integrity Level (SIL 3) acc. to IEC 61508.

### 3TK28 safety relays

#### With relay enabling circuits

Basic units	Basic units $t_v$	Expansion units	Two-hand control units
3TK28 20	3TK28 26	3TK28 30	3TK28 34
3TK28 21	3TK28 27		
3TK28 22	3TK28 28		
3TK28 23			
3TK28 24			
3TK28 25			
3TK28 26			

[See page 3/199](#)

#### With electronic enabling circuits

Basic units	Basic units $t_v$	Multifunction units
3TK28 40	3TK28 42	3TK28 45
3TK28 41		

[See page 3/204](#)

#### With contactor relay enabling circuits

Basic units	Expansion units	Expansion units $t_v$
3TK28 50	3TK28 56	3TK28 57
3TK28 51		
3TK28 52		
3TK28 53		

[See page 3/207](#)

#### With special functions

Standstill monitors	Overspeed Monitors
3TK28 10-0	3TK28 10-1

[See page 3/210](#)

## Benefits

### General

- Can be used for all safety applications thanks to compliance with the highest safety requirements (PL e according to ISO 13849-1 or SIL 3 according to IEC 61508)
- Suitable for use all over the world through compliance with all globally established certifications
- Compact, service-proven SIRIUS design creates more space in the control cabinet
- Flexible connectability and expendability make subsequent changes easy
- Removable terminals for greater plant availability
- Yellow front plate clearly identifies the device as an item of safety technology
- Sensor cable up to 2000 m long enables use in large-scale plants

### Relay outputs

- Different voltages can be switched through the floating contacts
- Higher currents can be switched with relay contacts

### Solid-state outputs

- Wear-free
- Suitable for operation in fast switching applications
- Insensitive to vibrations and dirt
- Good electrical endurance

### Microprocessor systems

- Flexible use thanks to many different integrated functions
- Easy parameterization using DIP switches on the front
- High functional reliability based on extensive monitoring functions
- Operated by the machine control
- Also connection of non-contact sensors (light arrays, light barriers etc.)

## Application

SIRIUS safety relays are used mainly in autonomous safety applications which are not connected to a safety-oriented bus system. Their function here is to evaluate the sensors and the safety-oriented shutdown of hazards. Also they check and monitor the sensors, actuators and safety-oriented functions of the safety relay.

## Overview



SIRIUS 3TK28 2. safety relay

### Safety relays with with relay enabling circuits – safety with floating contacts

SIRIUS safety relays with relay enabling circuits not only save a great deal of space thanks to their compact design but also offer extra safety in the form of positively driven pairs of make and break contacts. If one of the contacts becomes welded, the other will disconnect the circuit. A positively driven break contact (NC) then performs the fault detection of the faulty make contact (NO).

For two-hand operation consoles in press control systems the 3TK28 34 press control device serves as a safe evaluation unit.

3TK28 30 expansion units are available to increase the number of enabling circuits.

### 3TK28 26 safety relays

The 3TK28 26 is a parameterizable safety relay. It is used as an evaluation unit for typical safety chains (detection, evaluation, disconnection). DIP switches on the front can be used to set many different functions. The 3TK28 26 is therefore universally applicable.

Safety sensors (e.g. EMERGENCY-STOP pushbuttons) are connected at the input side while contactors or valves for disconnecting the "hazardous function" are connected at the output side. The 3TK28 26 performs the monitoring of the sensor and actuator functions as well as the safe disconnection of the outputs (enabling circuits).

### 3TK28 26 with DIP switch

OFF	Schematic	DIP switch No.	ON
Without crossover monitoring		1	Switching mat operation
NC/NO evaluation:		2	NC/NC contact evaluation
2 x 1-channel		3	1 x 2-channel
Debounce time for sensor inputs ≈ 50 ms		4	Debounce time for sensor inputs ≈ 10 ms
Autostart sensor input		5	Monitored start sensor input
Cascading input autostart		6	Cascading input monitored start
With start test		7	Without start test
Automatic start after mains failure (not permitted in connection with a start test)		8	Without automatic start after mains failure

## Benefits

### General

- Compact design
- Floating safe outputs
- 3TK28 34 safety relays also suitable for press and punch controls
- Can be used up to an ambient temperature of max. 70 °C

### 3TK28 26 safety relays

- Connection of all standard sensor types
- Many functions available in a single unit
- Status displays
- Expanded diagnostics options
- Approvals (EN 13849-1, IEC 61508, UL/CSA)
- Signaling of disconnect faults in the actuator circuit
- Floating outputs
- Units with wide voltage range
- Saving of the sensor status in the event of voltage failure

# SIRIUS 3TK28 safety relays

## With relay enabling circuits

### Selection and ordering data

Type	Basic units 3TK28 20	3TK28 21	3TK28 22	3TK28 23	3TK28 24	3TK28 25
<b>Sensors</b>						
• Input	1	1	1	1	1	1
• Solid-state	--	--	--	--	--	--
• With contacts	✓	✓	✓ <sup>1)</sup>	✓	✓	✓
• Magnetically operated switch (Reed contacts)	✓	--	--	--	--	--
<b>Safety mats</b>	--	--	--	--	--	--
<b>Start</b>						
• Auto	✓	✓	✓	--	✓	✓
• Monitored	✓	✓	--	✓	--	✓
<b>Cascading input 24 V DC</b>	--	--	--	--	--	--
<b>Key-operated switch</b>	--	--	--	--	--	--
<b>Enabling circuit, floating</b>						
• Stop category 0	3 NO	3 NO	2 NO	2 NO	2 NO	3 NO
• Stop category 1	--	--	--	--	--	--
<b>Enabling circuit, solid-state</b>						
• Stop category 0	--	--	--	--	--	--
• Stop category 1	--	--	--	--	--	--
<b>Signaling outputs</b>						
• Floating	1 NC	1 NC	--	--	--	2 NC
• Solid-state	--	--	--	--	--	--
<b>Standards</b>	EN 60204-1, EN ISO 12100, ISO 13849-1, IEC 61508	EN 60204-1, EN ISO 12100, EN 954-1, IEC 61508	EN 60204-1, EN ISO 12100, EN 954-1, IEC 61508	EN 60204-1, EN ISO 12100, EN 954-1, IEC 61508	EN 60204-1, EN ISO 12100, EN 954-1, IEC 61508	EN 60204-1, EN ISO 12100, EN 954-1, IEC 61508
<b>Compliance to standards</b>	TÜV, UL, CSA	BG, SUVA, UL, CSA	BG, SUVA, UL, CSA	BG, SUVA, UL, CSA	BG, SUVA, UL, CSA	BG, SUVA, UL, CSA
<b>Category according to EN 954-1 max</b>	4 (according to ISO 13849-1)	3 <sup>2)</sup>	4	4	3 <sup>2)</sup>	4
<b>SIL level max. according to IEC 61508</b>	3	1	3	3	1	3
<b>Performance level PL according to ISO 13849-1</b>	e	c	e	e	c	e
<b>Probability of a danger- ous failure per hour (PFH<sub>d</sub>)</b>	9.38 x 10 <sup>-10</sup> /h	1.1 x 10 <sup>-9</sup> 1/h	1.3 x 10 <sup>-9</sup> 1/h	1.3 x 10 <sup>-9</sup> 1/h	8.7 x 10 <sup>-10</sup> 1/h	1.5 x 10 <sup>-9</sup> 1/h
<b>Rated control supply voltage</b>						
• 24 V DC	--	--	--	--	✓	✓
• 24 V AC/DC	✓	✓	✓	✓	✓	--
• 24 V AC	--	--	--	--	--	✓
• 115 V AC	✓	--	--	--	✓	✓
• 230 V AC	✓	--	--	--	✓	✓
• 24 ... 240 V AC/DC	--	--	--	--	--	--

✓ Available

-- Not available

1) The ON button is not monitored.

2) Depending on the hazard assessment, additional measures may be necessary in the sensor circuit (e.g. protected laying).



## With relay enabling circuits

Type	Basic units						Two-hand control devices 3TK28 34	Expansion units <sup>2)</sup> 3TK28 30
	3TK28 26		3TK28 27		3TK28 28			
	24 V DC	Wide voltage range	24 V DC $t_v$	Wide voltage range $t_v$	$t_v$	$t_v$		
<b>Sensors</b>								
• Input	1	1	1	1	1	1	1	--
• Solid-state	✓	✓	✓	✓	--	--	--	--
• With contacts	✓	✓	✓	✓	✓	✓	✓	--
• Magnetically operated switch (Reed contacts)	✓	✓	✓	✓	--	--	--	--
<b>Safety mats</b>	✓	✓	✓	✓	--	--	--	--
<b>Start</b>								
• Auto	✓	✓	✓	✓	--	✓	--	--
• Monitored	✓	✓	✓	✓	✓	--	--	--
<b>Cascading input 24 V DC</b>	✓	✓	✓	✓	--	--	--	--
<b>Key-operated switch</b>	--	--	--	--	--	--	--	--
<b>Enabling circuit, floating</b>								
• Stop category 0	4 NO	4 NO	2 NO	2 NO	2 NO	2 NO	2 NO+2 NC	4 NO
• Stop category 1	--	--	2 NO	2 NO	2 NO	2 NO	--	--
<b>Enabling circuit, solid-state</b>								
• Stop category 0	--	--	--	--	--	--	--	--
• Stop category 1	--	--	--	--	--	--	--	--
<b>Signaling outputs</b>								
• Floating	1 NC	1 NO + 1 NC	2 NC	1 NO + 2 NC	1 NC	1 NC	2	--
• Solid-state	2	--	2	--	--	--	--	--
<b>Standards</b>	EN 60204-1, EN ISO 12100, EN 954-1, IEC 61508	EN 60204-1, EN ISO 12100, EN 954-1, IEC 61508	EN 60204-1, EN ISO 12100, EN 954-1, IEC 61508	EN 60204-1, EN ISO 12100, EN 954-1, IEC 61508	EN 60204-1, EN ISO 12100, EN 954-1, IEC 61508	EN 60204-1, EN ISO 12100, EN 954-1, IEC 61508	EN 60204-1, EN ISO 12100, EN 954-1, IEC 61508, EN 574	EN 60204-1, EN ISO 12100, EN 954-1, IEC 61508
<b>Compliance to standards</b>	TÜV, UL, CSA	TÜV, UL, CSA	TÜV, UL, CSA	TÜV, UL, CSA	BG, SUVA, UL, CSA	BG, SUVA, UL, CSA	BG, SUVA, UL, CSA, TÜV	BG, SUVA, UL, CSA, TÜV
<b>Category according to EN 954-1 max</b>	4	4	4	4	4 <sup>1)</sup>	4 <sup>1)</sup>	4	As basic unit
<b>SIL level max. according to IEC 61508</b>	3	3	3	3	3 <sup>3)</sup>	3 <sup>3)</sup>	--	As basic unit
<b>Performance level PL according to ISO 13849-1</b>	e	e	e	e	e <sup>3)</sup>	e <sup>3)</sup>	--	As basic unit
<b>Probability of a dangerous failure per hour (PFH<sub>d</sub>)</b>	7.8 x 10 <sup>-9</sup> 1/h	7.8 x 10 <sup>-9</sup> 1/h	7.8 x 10 <sup>-9</sup> 1/h	7.8 x 10 <sup>-9</sup> 1/h	2.7 x 10 <sup>-9</sup> 1/h	2.7 x 10 <sup>-9</sup> 1/h	1.4 x 10 <sup>-9</sup> 1/h	1.2 x 10 <sup>-9</sup> 1/h
<b>Rated control supply voltage</b>								
• 24 V DC	✓	--	✓	--	✓	✓	✓	--
• 24 V AC/DC	--	--	--	--	--	--	--	✓
• 24 V AC	--	--	--	--	✓	✓	✓	--
• 115 V AC	--	--	--	--	✓	✓	✓	✓
• 230 V AC	--	--	--	--	✓	✓	✓	✓
• 24 ... 240 V AC/DC	--	✓	--	✓	--	--	--	--

✓ Available

-- Not available

1) Only possible for instantaneous enabling contacts, otherwise Category 3.

2) For expansion of Siemens safety products.

3) Only possible for instantaneous enabling contacts, otherwise SIL 2 or Performance Level PL d.

# SIRIUS 3TK28 safety relays

## With relay enabling circuits



3TK28 21-1CB30



3TK28 25-1BB40



3TK28 26-2BB40



3TK28 27-1BB41



Rated control supply voltage $U_s$	Start	OFF-delay $t_v$	DT	Screw terminals	DT	Spring-type terminals
V		s		Order No.		Order No.
<b>Basic units</b>						
<i>With floating enabling circuits</i>						
<b>3TK28 20</b>						
• 24 AC/DC	Auto/monitored	--	▶	3TK28 20-1CB30	▶	3TK28 20-2CB30
• 115 AC	Auto/monitored	--	▶	3TK28 20-1AJ20	▶	3TK28 20-2AJ20
• 230 AC	Auto/monitored	--	▶	3TK28 20-1AL20	▶	3TK28 20-2AL20
<b>3TK28 21</b>						
• 24 AC/DC	Auto	--	▶	3TK28 21-1CB30	▶	3TK28 21-2CB30
<b>3TK28 22</b>						
• 24 AC/DC	Auto	--	▶	3TK28 22-1CB30	A	3TK28 22-2CB30
<b>3TK28 23</b>						
• 24 AC/DC	Monitored	--	▶	3TK28 23-1CB30	A	3TK28 23-2CB30
<b>3TK28 24</b>						
• 24 AC/DC	Auto	--	▶	3TK28 24-1CB30	A	3TK28 24-2CB30
• 24 DC	Auto	--	▶	3TK28 24-1BB40	▶	3TK28 24-2BB40
• 115 AC	Auto	--	C	3TK28 24-1AJ20	C	3TK28 24-2AJ20
• 230 AC	Auto	--	▶	3TK28 24-1AL20	B	3TK28 24-2AL20
<b>3TK28 25</b>						
• 24 DC	Auto/monitored	--	▶	3TK28 25-1BB40	▶	3TK28 25-2BB40
• 24 AC	Auto/monitored	--	A	3TK28 25-1AB20	C	3TK28 25-2AB20
• 115 AC	Auto/monitored	--	▶	3TK28 25-1AJ20	B	3TK28 25-2AJ20
• 230 AC	Auto/monitored	--	▶	3TK28 25-1AL20	B	3TK28 25-2AL20
<b>3TK28 26</b>						
• 24 DC	Auto/monitored	--	▶	3TK28 26-1BB40	A	3TK28 26-2BB40
• 24 ... 240 AC/DC	Auto/monitored	--	▶	3TK28 26-1CW30	A	3TK28 26-2CW30
<i>With time-delay enabling circuits</i>						
<b>3TK28 26 <math>t_v</math></b>						
• 24 DC	Auto/monitored	0.05 ... 3	A	3TK28 26-1BB41	A	3TK28 26-2BB41
• 24 ... 240 AC/DC	Auto/monitored	0.05 ... 3	A	3TK28 26-1CW31	A	3TK28 26-2CW31
• 24 DC	Auto/monitored	0.5 ... 30	A	3TK28 26-1BB42	A	3TK28 26-2BB42
• 24 ... 240 AC/DC	Auto/monitored	0.5 ... 30	A	3TK28 26-1CW32	A	3TK28 26-2CW32
• 24 DC	Auto/monitored	5 ... 300	A	3TK28 26-1BB44	A	3TK28 26-2BB44
• 24 ... 240 AC/DC	Auto/monitored	5 ... 300	A	3TK28 26-1CW34	A	3TK28 26-2CW34
<b>3TK28 27 <math>t_v</math></b>						
• 24 DC	Monitored	0.05 ... 3	▶	3TK28 27-1BB41	A	3TK28 27-2BB41
• 24 AC	Monitored	0.05 ... 3	B	3TK28 27-1AB21	B	3TK28 27-2AB21
• 115 AC	Monitored	0.05 ... 3	B	3TK28 27-1AJ21	B	3TK28 27-2AJ21
• 230 AC	Monitored	0.05 ... 3	A	3TK28 27-1AL21	B	3TK28 27-2AL21
• 24 DC	Monitored	0.5 ... 30	▶	3TK28 27-1BB40	A	3TK28 27-2BB40
• 24 AC	Monitored	0.5 ... 30	A	3TK28 27-1AB20	C	3TK28 27-2AB20
• 115 AC	Monitored	0.5 ... 30	▶	3TK28 27-1AJ20	C	3TK28 27-2AJ20
• 230 AC	Monitored	0.5 ... 30	▶	3TK28 27-1AL20	B	3TK28 27-2AL20
<b>3TK28 28 <math>t_v</math></b>						
• 24 DC	Auto	0.05 ... 3	▶	3TK28 28-1BB41	A	3TK28 28-2BB41
• 24 AC	Auto	0.05 ... 3	B	3TK28 28-1AB21	C	3TK28 28-2AB21
• 115 AC	Auto	0.05 ... 3	B	3TK28 28-1AJ21	B	3TK28 28-2AJ21
• 230 AC	Auto	0.05 ... 3	A	3TK28 28-1AL21	B	3TK28 28-2AL21
• 24 DC	Auto	0.5 ... 30	▶	3TK28 28-1BB40	▶	3TK28 28-2BB40
• 24 AC	Auto	0.5 ... 30	B	3TK28 28-1AB20	B	3TK28 28-2AB20
• 115 AC	Auto	0.5 ... 30	A	3TK28 28-1AJ20	B	3TK28 28-2AJ20
• 230 AC	Auto	0.5 ... 30	A	3TK28 28-1AL20	B	3TK28 28-2AL20

## SIRIUS 3TK28 safety relays

With relay enabling circuits



3TK28 30-1CB30

Rated control supply voltage $U_s$	Start	OFF-delay $t_v$	DT	Screw terminals 	DT	Spring-type terminals 
				Order No.	Order No.	
V		s				
<b>Two-hand control devices</b>						
<i>With floating enabling circuits</i>						
<b>3TK28 34</b>						
• 24 DC	--	--	▶	<b>3TK28 34-1BB40</b>	A	<b>3TK28 34-2BB40</b>
• 24 AC	--	--	A	<b>3TK28 34-1AB20</b>	B	<b>3TK28 34-2AB20</b>
• 115 AC	--	--	A	<b>3TK28 34-1AJ20</b>	C	<b>3TK28 34-2AJ20</b>
• 230 AC	--	--	A	<b>3TK28 34-1AL20</b>	B	<b>3TK28 34-2AL20</b>
<b>Expansion units</b>						
<i>With floating enabling circuits</i>						
<b>3TK28 30</b>						
• 24 AC/DC	--	--	▶	<b>3TK28 30-1CB30</b>	▶	<b>3TK28 30-2CB30</b>
• 115 AC	--	--	A	<b>3TK28 30-1AJ20</b>	B	<b>3TK28 30-2AJ20</b>
• 230 AC	--	--	A	<b>3TK28 30-1AL20</b>	B	<b>3TK28 30-2AL20</b>

# SIRIUS 3TK28 safety relays

## With electronic enabling circuits

### Overview



SIRIUS 3TK28 4. safety relay

### **Quick, safe and wear-free switching**

Evaluation units with solid-state components are being used increasingly in safety applications because their permanent checking of functions and largely wear-free operation results in a far higher switching frequency and electrical endurance of equipment. The compact and lightweight units also permit series connection or normal switching duty, e.g. by a PLC.

If several enabling circuits or floating enabling circuits are required in one application, the units can be expanded with expansion units from the 3TK28 30 series.

### 3TK28 45 multi-function units

Up to now, standard combinations of safety applications such as EMERGENCY-STOP and protective door monitoring were possible only by using several individual safety relays. 3TK28 45 combines several functions in a single unit. Two solid-state enabling circuits and two relay enabling circuits ensure safe disconnection quickly and cost-efficiently in just a few moves.

### Benefits

- Permanent function checking
- No wear because switched electronically
- High switching frequency
- Long electrical endurance
- Evaluation of solid-state sensors
- Sensor lead up to max. 2000 m
- Cascading possible
- Insensitive to vibrations and dirt
- Compact design, low weight
- Approved for the world market

### **3TK28 45 safety relays**

- 2 sensor inputs (e.g. EMERGENCY-STOP, protective door)
- Also suitable for protective door interlocking and OK buttons
- 2 solid-state enabling circuits and 2 relay enabling circuits

## Selection and ordering data

Type	Basic units			Multi-function units							
	3TK28 40	3TK28 41	3TK28 42	3TK28 45		OK button		OK button		"Spring-locked interlock"	"Solenoid-locked interlock"
			$t_v$	"Auto-matic and monitored start"	"Auto-matic and monitored start"	"Moni-tored start"	"Moni-tored start"			"Spring-locked interlock"	"Solenoid-locked interlock"
				$t_v$	$t_v$					$t_v$	$t_v$
<b>Sensors</b>											
• Input	1	1	1	2	2	2	2	2	2	2	2
• Solid-state	--	✓	✓	✓	✓	✓	✓	✓	✓	✓	✓
• With contacts	✓	✓	✓	✓	✓	✓	✓	✓	✓	✓	✓
• Magnetically operated switch (Reed contacts)	✓	✓	✓	✓	✓	✓	✓	✓	✓	✓	✓
<b>Safety mats</b>	--	✓	✓	✓	✓	✓	✓	--	--	--	--
<b>Start</b>											
• Auto	✓	✓	✓	1	1	--	--	1	1	--	--
• Monitored	✓	✓	✓	1	1	2	2	1	1	2	2
<b>Cascading input 24 V DC</b>	--	✓	✓	✓	✓	✓	✓	✓	✓	✓	✓
<b>Key-operated switch</b>	--	--	--	✓	✓	✓	✓	✓	✓	✓	✓
<b>Enabling circuit, floating</b>											
• Stop category 0	--	--	--	2 NO	1 NO	2 NO	1 NO	2 NO	1 NO	1 NO	1 NO
• Stop category 1	--	--	--	--	1 NO	--	1 NO	--	1 NO	1 NO	1 NO
<b>Enabling circuit, solid-state</b>											
• Stop category 0	2 <sup>1)</sup>	2	1	2	1	2	1	2	1	1	1
• Stop category 1	--	--	1	--	1	--	1	--	1	1	1
<b>Signaling outputs</b>											
• Floating	--	--	--	--	--	--	--	--	--	--	--
• Solid-state	--	--	--	1	1	1	1	1	1	1	1
<b>Standards</b>	EN 60204-1, EN ISO 12100, EN 954-1, IEC 61508	EN 60204-1, EN ISO 12100, EN 954-1, IEC 61508 EN 50156-1						EN 60204-1, EN ISO 12100, EN 954-1, IEC 61508			
<b>Test certificates</b>	TÜV, UL, CSA										
<b>Category according to EN 954-1 max</b>	3	4	4	4	4	4	4	4	4	4	4
<b>SIL level max. according to IEC 61508</b>	2	3	3	3	3	3	3	3	3	3	3
<b>Performance level PL according to ISO 13849-1</b>	d	e	e	e	e	e	e	e	e	e	e
<b>Probability of a dangerous failure per hour (PFH<sub>d</sub>)</b>	$1.1 \times 10^{-8}$ 1/h	$5.4 \times 10^{-11}$ 1/h	$5.4 \times 10^{-11}$ 1/h	$6.9 \times 10^{-9}$ 1/h	$6.9 \times 10^{-9}$ 1/h	$6.9 \times 10^{-9}$ 1/h	$6.9 \times 10^{-9}$ 1/h	$6.9 \times 10^{-9}$ 1/h	$6.9 \times 10^{-9}$ 1/h	$6.9 \times 10^{-9}$ 1/h	$6.9 \times 10^{-9}$ 1/h
<b>Rated control supply voltage 24 V DC</b>	✓	✓	✓	✓	✓	✓	✓	✓	✓	✓	✓

✓ Available

-- Not available

1) The outputs are only safe when an external contactor is used.

# SIRIUS 3TK28 safety relays

## With electronic enabling circuits



3TK28 41-1BB40



3TK28 42-1BB41



3TK28 45-1HB40



3TK28 45-1HB41



3TK28 45-2DB40

Rated control supply voltage $U_s$	Start	OFF-delay $t_v$	DT	Screw terminals	DT	Spring-type terminals
V		s		Order No.		Order No.
<b>Basic units</b>						
<i>With electronic enabling circuits</i>						
<b>3TK28 40</b>						
• 24 DC	Auto/monitored	--	A	<b>3TK28 40-1BB40</b>	B	<b>3TK28 40-2BB40</b>
<b>3TK28 41</b>						
• 24 DC	Auto/monitored	--	A	<b>3TK28 41-1BB40</b>	A	<b>3TK28 41-2BB40</b>
<i>With time-delay enabling circuits</i>						
<b>3TK28 42 <math>t_v</math></b>						
• 24 DC	Auto/monitored	0.05 ... 3	A	<b>3TK28 42-1BB41</b>	B	<b>3TK28 42-2BB41</b>
	Auto/monitored	0.5 ... 30	A	<b>3TK28 42-1BB42</b>	A	<b>3TK28 42-2BB42</b>
	Auto/monitored	5 ... 300	A	<b>3TK28 42-1BB44</b>	B	<b>3TK28 42-2BB44</b>
<b>Multi-function units</b>						
<b>3TK28 45 "Automatic and monitored start"</b>						
• 24 DC	1/1	--	A	<b>3TK28 45-1HB40</b>	B	<b>3TK28 45-2HB40</b>
<b>3TK28 45 <math>t_v</math> "Automatic and monitored start"</b>						
• 24 DC	1/1	0.05 ... 3	A	<b>3TK28 45-1HB41</b>	B	<b>3TK28 45-2HB41</b>
	1/1	0.5 ... 30	A	<b>3TK28 45-1HB42</b>	B	<b>3TK28 45-2HB42</b>
	1/1	5 ... 300	A	<b>3TK28 45-1HB44</b>	B	<b>3TK28 45-2HB44</b>
<b>3TK28 45 "Monitored start"</b>						
• 24 DC	--/2	--	A	<b>3TK28 45-1DB40</b>	B	<b>3TK28 45-2DB40</b>
<b>3TK28 45 <math>t_v</math> "Monitored start"</b>						
• 24 DC	--/2	0.05 ... 3	A	<b>3TK28 45-1DB41</b>	B	<b>3TK28 45-2DB41</b>
	--/2	0.5 ... 30	A	<b>3TK28 45-1DB42</b>	B	<b>3TK28 45-2DB42</b>
	--/2	5 ... 300	C	<b>3TK28 45-1DB44</b>	B	<b>3TK28 45-2DB44</b>
<b>3TK28 45 "OK button"</b>						
• 24 DC	1/1	--	A	<b>3TK28 45-1EB40</b>	B	<b>3TK28 45-2EB40</b>
<b>3TK28 45 <math>t_v</math> "OK button"</b>						
• 24 DC	1/1	0.05 ... 3	A	<b>3TK28 45-1EB41</b>	B	<b>3TK28 45-2EB41</b>
	1/1	0.5 ... 30	A	<b>3TK28 45-1EB42</b>	B	<b>3TK28 45-2EB42</b>
	1/1	5 ... 300	C	<b>3TK28 45-1EB44</b>	B	<b>3TK28 45-2EB44</b>
<b>3TK28 45 <math>t_v</math> "Spring-locked interlock"</b>						
• 24 DC	--/2	0.05 ... 3	A	<b>3TK28 45-1FB41</b>	B	<b>3TK28 45-2FB41</b>
	--/2	0.5 ... 30	A	<b>3TK28 45-1FB42</b>	B	<b>3TK28 45-2FB42</b>
	--/2	5 ... 300	B	<b>3TK28 45-1FB44</b>	B	<b>3TK28 45-2FB44</b>
<b>3TK28 45 <math>t_v</math> "Solenoid-locked interlock"</b>						
• 24 DC	--/2	0.05 ... 3	A	<b>3TK28 45-1GB41</b>	B	<b>3TK28 45-2GB41</b>
	--/2	0.5 ... 30	A	<b>3TK28 45-1GB42</b>	B	<b>3TK28 45-2GB42</b>
	--/2	5 ... 300	C	<b>3TK28 45-1GB44</b>	B	<b>3TK28 45-2GB44</b>

With contactor relay enabling circuits

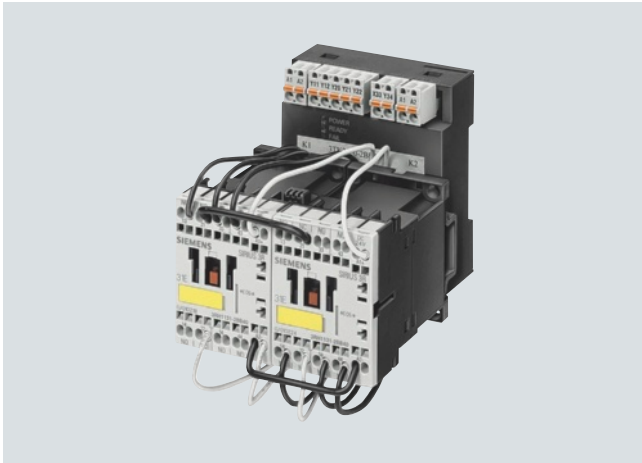
**Overview**

SIRIUS 3TK28 5. safety relay

***The 3-in-1 complete unit***

The 3TK28 5. safety relays are a perfect combination of solid-state safety functionality and two redundant SIRIUS contactor relays with contacts. They are ready-assembled, wired, tested and certified as a unit.

Expansion units (3TK28 56 and 3TK28 57) are available to increase the number of enabling circuits.

**Benefits**

- Enabling circuits, floating
- AC-15/DC-13 switching capacity
- Protective separation
- Long mechanical and electrical endurance
- Certified as a complete unit
- Fault minimization and cost reduction through factory wiring
- Low installation costs

# SIRIUS 3TK28 safety relays

## With contactor relay enabling circuits

### Selection and ordering data

Type	Basic units				Expansion units <sup>1)</sup>	
	3TK28 50	3TK28 51	3TK28 52	3TK28 53	3TK28 56	3TK28 57 t <sub>v</sub>
<b>Sensors</b>						
• Input	1	1	1	1	--	--
• Solid-state	--	--	--	✓	--	--
• With contacts	✓	✓	✓	✓	--	--
• Magnetically operated switch (Reed contacts)	✓	✓	✓	✓	--	--
<b>Safety mats</b>	✓	✓	✓	✓	--	--
<b>Start</b>						
• Auto	✓	✓	✓	✓	--	--
• Monitored	✓	✓	✓	✓	--	--
<b>Cascading input 24 V DC</b>	--	--	--	✓	✓	✓
<b>Key-operated switch</b>	--	--	--	--	--	--
<b>Enabling circuit, floating</b>						
• Stop category 0	3 NO	2 NO	6 NO	3 NO	6 NO	--
• Stop category 1	--	--	--	--	--	3 NO
<b>Enabling circuit, solid-state</b>						
• Stop category 0	--	--	--	1	1	1
• Stop category 1	--	--	--	--	--	--
<b>Signaling outputs</b>						
• Floating	--	1 NC	1 NC	--	1 NC	--
• Solid-state	--	--	--	--	--	--
<b>Standards</b>	EN 60204-1, EN ISO 12100, EN 954-1, IEC 61508	EN 60204-1, EN ISO 12100, EN 954-1, IEC 61508	EN 60204-1, EN ISO 12100, EN 954-1, IEC 61508	EN 60204-1, EN ISO 12100, EN 954-1, IEC 61508	EN 60204-1, EN ISO 12100, EN 954-1, IEC 61508	EN 60204-1, EN ISO 12100, EN 954-1, IEC 61508
<b>Test certificates</b>	TÜV, UL, CSA	TÜV, UL, CSA	TÜV, UL, CSA	TÜV, UL, CSA	TÜV, UL, CSA	TÜV, UL, CSA
<b>Category according to EN 954-1 max</b>	3	3	3	4	As basic unit	As basic unit
<b>SIL level max. according to IEC 61508</b>	2	2	2	--	As basic unit	As basic unit
<b>Performance level PL according to ISO 13849-1</b>	d	d	d	e	As basic unit	As basic unit
<b>Probability of a dangerous failure per hour (PFH<sub>d</sub>)</b>	1.2 x 10 <sup>-8</sup> 1/h	1.1 x 10 <sup>-8</sup> 1/h	1.1 x 10 <sup>-8</sup> 1/h	1.1 x 10 <sup>-8</sup> 1/h	1.1 x 10 <sup>-8</sup> 1/h	1.1 x 10 <sup>-8</sup> 1/h
<b>Rated control supply voltage</b>						
• 24 V DC	✓	✓	✓	✓	✓	✓
• 24 V AC/DC	--	--	--	--	--	--
• 24 V AC	✓	✓	--	--	--	--
• 115 V AC	✓	✓	--	--	--	--
• 230 V AC	✓	✓	✓	--	--	--
• 24 ... 240 V AC/DC	--	--	--	--	--	--
<b>Rated operational voltage</b>						
• 24 V DC	✓	✓	✓	✓	✓	✓
• 230 V AC	✓	✓	✓	✓	✓	✓
• 600 V AC	✓	✓	✓	✓	✓	✓
<b>Switching capacity</b>						
• AC-15 at U = 230 V	6 A	6 A	6 A	6 A	6 A	6 A
• DC-13 at U = 24 V	10 A	10 A	10 A	10 A	10 A	10 A

✓ Available

-- Not available

1) For expansion of Siemens safety products.



## SIRIUS 3TK28 safety relays

With contactor relay enabling circuits





3TK28 50-2BB40



3TK28 51-2BB40



3TK28 52-2BB40

Rated control supply voltage $U_s$	Start	OFF-delay $t_v$	DT	Screw terminals 	DT 
V		s		Order No.	Order No.
<b>Basic units</b>					
<i>With contactor relay enabling circuits</i>					
<b>3TK28 50</b>					
• 24 DC	Auto/monitored	--	A	<b>3TK28 50-1BB40</b>	B <b>3TK28 50-2BB40</b>
• 115 AC	Auto/monitored	--	B	<b>3TK28 50-1AJ20</b>	B <b>3TK28 50-2AJ20</b>
• 230 AC	Auto/monitored	--	B	<b>3TK28 50-1AL20</b>	B <b>3TK28 50-2AL20</b>
<b>3TK28 51</b>					
• 24 DC	Auto/monitored	--	B	<b>3TK28 51-1BB40</b>	B <b>3TK28 51-2BB40</b>
• 115 AC	Auto/monitored	--	C	<b>3TK28 51-1AJ20</b>	B <b>3TK28 51-2AJ20</b>
• 230 AC	Auto/monitored	--	C	<b>3TK28 51-1AL20</b>	B <b>3TK28 51-2AL20</b>
<b>3TK28 52</b>					
• 24 DC	Auto/monitored	--	A	<b>3TK28 52-1BB40</b>	B <b>3TK28 52-2BB40</b>
• 230 AC	Auto/monitored	--	B	<b>3TK28 52-1AL20</b>	B <b>3TK28 52-2AL20</b>
<b>3TK28 53</b>					
• 24 DC	Auto/monitored	--	A	<b>3TK28 53-1BB40</b>	B <b>3TK28 53-2BB40</b>
<b>Expansion units</b>					
<i>With contactor relay enabling circuits</i>					
<b>3TK28 56</b>					
• 24 DC	--	--	B	<b>3TK28 56-1BB40</b>	B <b>3TK28 56-2BB40</b>
<b>3TK28 57 <math>t_v</math></b>					
• 24 DC	--	0.05 ... 3	A	<b>3TK28 57-1BB41</b>	B <b>3TK28 57-2BB41</b>
• 24 DC	--	0.5 ... 30	B	<b>3TK28 57-1BB42</b>	B <b>3TK28 57-2BB42</b>
• 24 DC	--	5 ... 300	B	<b>3TK28 57-1BB44</b>	B <b>3TK28 57-2BB44</b>

# SIRIUS 3TK28 safety relays

## With special functions

### Overview



SIRIUS 3TK28 10 safety relays

#### **3TK28 10-0 standstill monitors**

The standstill monitor increases safety in hazardous areas. Without a sensor, it detects motor stoppage from the residual magnetization of the rotating motor. When an adjustable threshold value is undershot, it uses its outputs to allow access to hazardous areas for example by unlocking a protective door.

#### **3TK28 10-1 overspeed monitors**

The overspeed monitor combines two safety functions in one unit by continuously monitoring machines and plants for standstill and speed.

Through simple parameterization and permanent diagnosis on the display, faults can be quickly remedied at any time – often before they cause plant downtimes.

In addition to standstill and speed monitoring the unit also features integrated monitoring of a protective door with spring-type interlocking. An additional evaluation unit is not needed.

### Benefits

#### **3TK28 10-0 standstill monitor**

- No additional sensors required
- Signaling of faults with diagnostics display
- Standstill time can be set
- Unit can be used with frequency converters

#### **3TK28 10-1 overspeed monitors**

- Menu-prompted, easy parameterization
- Direct diagnosis on the display means shorter downtimes thanks to early fault detection
- Integrated protective door monitoring means greater safety because access to the plant is allowed only in the safe state
- Suitable for all standard sensors, i.e. high flexibility

With special functions

## Selection and ordering data

Type	Standstill monitors 3TK28 10-0	Overspeed monitors 3TK28 10-1
<b>Sensors</b>		
• Input	3	4
• Solid-state	--	3
• With contacts	--	1
• Without sensors (measuring inputs)	3	--
• Magnetically operated switch (Reed contacts)	--	--
<b>Safety mats</b>	--	--
<b>Start</b>		
• Auto	✓	✓
• Monitored	--	✓
<b>Cascading input 24 V DC</b>	--	--
<b>Key-operated switch</b>	--	--
<b>Enabling circuit, floating</b>		
• Stop category 0	3 NO + 1 NC	2
• Stop category 1	--	--
<b>Enabling circuit, solid-state</b>		
• Stop category 0	--	--
• Stop category 1	--	--

✓ Available

-- Not available



3TK28 10-0BA01



3TK28 10-0GA02



3TK28 10-1BA41

Type	Standstill monitors 3TK28 10-0	Overspeed monitors 3TK28 10-1
<b>Signaling outputs</b>		
• Floating	1 CO	--
• Solid-state	2	2
<b>Standards</b>	EN 60204-1, EN ISO 12100, EN 954-1, IEC 61508	IEC 60947-5-1, EN ISO 13849-1, EN 60204-1, IEC 61508
<b>Test certificates</b>	TÜV, UL, CSA	TÜV
<b>Category according to EN 954-1 max</b>	4	4
<b>SIL level max. according to IEC 61508</b>	3	3
<b>Performance level PL according to ISO 13849-1</b>	e	e
<b>Probability of a dangerous failure per hour (PFH<sub>d</sub>)</b>	1.5 x 10 <sup>-8</sup> 1/h	3.38 x 10 <sup>-9</sup> 1/h
<b>Rated control supply voltage</b>		
• 24 V DC	✓	✓
• 230 V AC	✓	--
• 400 V AC	✓	--
• 120 ... 240 V AC/DC	--	✓





3

Rated control supply voltage $U_s$	OFF-delay $t_v$	DT	Screw terminals	DT	Spring-type terminals
V	s		Order No.		Order No.
<b>Standstill monitors</b>					
<b>3TK28 10-0</b>					
• 24 DC	0.2... 6	A	3TK28 10-0BA01	A	3TK28 10-0BA02
• 230 AC	0.2... 6	A	3TK28 10-0GA01	A	3TK28 10-0GA02
• 400 AC	0.2... 6	A	3TK28 10-0JA01	B	3TK28 10-0JA02
<b>Overspeed monitors</b>					
<b>3TK28 10-1</b>					
• 24 DC	0 ... 600	A	3TK28 10-1BA41	A	3TK28 10-1BA42
• 120 ... 240 AC/DC	0 ... 600	A	3TK28 10-1KA41	A	3TK28 10-1KA42

# SIRIUS 3TK28 safety relays

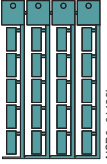
## Accessories

### Accessories

Use	Version	DT	Order No.
<b>Blank labels</b>			
 NSB90_014286 3RT19 00-1SB20	For 3TK28	<b>Unit labeling plates</b> For SIRIUS devices 20 mm x 7 mm, pastel turquoise <sup>1)</sup>	D <b>3RT19 00-1SB20</b>
	For 3TK28	<b>Inscription labels for sticking</b> For SIRIUS devices 19 mm x 6 mm, pastel turquoise	C <b>3RT19 00-1SB60</b>
		19 mm x 6 mm, zinc yellow	C <b>3RT19 00-1SD60</b>
<b>Push-in lugs and covers</b>			
 3RP19 03	For 3TK28	<b>Push-in lugs</b> For screw fixing, 2 units are required for each device	▶ <b>3RP19 03</b>
	 3RP19 02	For 3TK28 21 to 3TK28 25, 3TK28 27, 3TK28 28, 3TK28 3.	<b>Sealable covers</b> For securing against unauthorized adjustment of setting knobs
For 3TK28 26			B <b>3TK28 26-ODA00-OHA0</b>
	For 3TK28 20	<b>Sealing foil</b> For securing against unauthorized adjustment of setting knobs	▶ <b>3TK28 20-OAA00</b>
<b>Accessories for speed acquisition</b>			
		<b>Cable</b> for connecting encoder / for copy-function	<b>3TK2810-0A</b>
		<b>Adapter</b> <sup>2)</sup> for connecting encoder Siemens / Heidenhain, 15-pole	<b>3TK2810-1A</b>
		<b>Adapter</b> <sup>2)</sup> for connecting encoder Siemens / Heidenhain, 25-pole	<b>3TK2810-1B</b>
<b>Tools for opening spring-type terminals by hand</b>			
 3RA29 08-1A	For auxiliary circuit connections	<b>Screwdrivers</b> For all SIRIUS devices with spring-type terminals 3.0 mm x 0.5 mm, length approx. 200 mm, titanium gray/black, partially insulated	A
			<b>Spring-type terminals</b>  <b>3RA29 08-1A</b>

<sup>1)</sup> PC labeling system for individual inscription of unit labeling plates available from: murrplastik Systemtechnik GmbH [www.murrplastik.de](http://www.murrplastik.de)

<sup>2)</sup> The adapters (15-pole and 25-pole) are needed to connect the encoder, the control unit and the speed/standstill monitors.

### Overview



SIMOCODE pro V with current/voltage measuring module, fail-safe expansion module and operator panel with display

SIMOCODE pro is a flexible, modular motor management system for motors with constant speeds in the low-voltage performance range. It optimizes the connection between I&C and motor feeder, increases plant availability and allows significant savings to be made for startup, operation and maintenance of a system.

When SIMOCODE pro is installed in the low-voltage switchboard, it is the intelligent interface between the higher-level automation system and the motor feeder and includes the following:

- Multifunctional, solid-state full motor protection which is independent of the automation system
- Integrated control functions instead of hardware for the motor control
- Detailed operating, service and diagnostics data
- Open communication through PROFIBUS DP, the standard for fieldbus systems
- Safety relay function for the fail-safe disconnection of motors up to SIL 3 (IEC 61508/62061) or PL e with Category 4 (ISO 13849-1)

SIMOCODE ES is the software package for SIMOCODE pro parameterization, start-up and diagnostics.

#### Two series

SIMOCODE pro is structured into two functionally tiered series:

- SIMOCODE pro C, as a compact system for direct-on-line starters and reversing starters or the actuation of a circuit breaker
- SIMOCODE pro V, as a variable system with all control functions and with the possibility of expanding the inputs, outputs and functions of the system at will using expansion modules

#### Order No. scheme

Digit of the Order No.	1st - 4th	5th	6th	7th	8th	9th	10th	11th	12th	13th		
	□□□□	□	□	□	-	1	□	□	0	0	-	0
<b>SIMOCODE pro motor management system</b>	<b>3 U F 7</b>											
<b>Type of unit/module</b>	□											
<b>Functional version of the unit/module</b>	□ □											
<b>Connection type of the current transformer</b>	□											
<b>Voltage version</b>	□											
<b>Example</b>	<b>3 U F 7 0 1 0 - 1 A A 0 0 - 0</b>											

#### Note:

The Order No. scheme is presented here merely for information purposes and for better understanding of the logic behind the order numbers.

For your orders, please use the order numbers quote in the catalog in the Selection and ordering data.

Expansion possibilities	SIMOCODE pro C, Basic Unit 1	SIMOCODE pro V, Basic Unit 2 <sup>1)</sup>
Operator panels	✓	✓
Operator panels with display	--	✓
Current measuring modules	✓	✓
Current/voltage measuring modules	--	✓
Decoupling modules	--	✓
Expansion modules:		
• Digital modules (max. 2)	--	✓
• Fail-safe digital module (max. 1) <sup>2)</sup>	--	✓
• Analog module (max. 1)	--	✓
• Ground-fault module (max. 1)	--	✓
• Temperature module (max. 1)	--	✓

✓ Available -- Not available

<sup>1)</sup> When an operator panel with display and/or a decoupling module is used, more restrictions on the number of expansion modules connectable per basic unit must be observed, see page 3/219.

<sup>2)</sup> The fail-safe digital module can be used instead of one of the two digital modules.

Per feeder each system always comprises one basic unit and one separate current measuring module. The two modules are connected together electrically through the system interface with a connection cable and can be mounted mechanically connected as a unit (one behind the other) or separately (side by side). The motor current to be monitored is decisive only for the choice of the current measuring module.

An operator panel for mounting in the control cabinet door is optionally connectable through a second system interface on the basic unit. Both the current measuring module and the operator panel are electrically supplied by the basic unit through the connection cable. More inputs, outputs and functions can be added to basic unit 2 (SIMOCODE pro V) by means of optional expansion modules, thus supplementing the inputs and outputs already existing on the basic unit. With the DM-F Local and DM-F PROFIsafe fail-safe digital modules it is also possible to integrate the fail-safe disconnection of motors in the SIMOCODE pro V motor management system.

All modules are connected by connection cables. The connection cables are available in various lengths. The maximum distance between the modules (e.g. between the basic unit and the current measuring module) must not exceed 2.5m. The total length of all the connection cables in a single system must not be more than 3 m.

# SIMOCODE 3UF motor management and control devices

## SIMOCODE pro 3UF7

### General data

#### Benefits

##### General customer benefits

- Integrating the whole motor feeder into the process control by means of a bus significantly reduces the wiring outlay between the motor feeder and PLC
- Decentralization of the automated processes by means of configurable control and monitoring functions in the feeder saves resources in the automation system and ensures full functionality and protection of the feeder even if the I&C or bus system fails
- The acquisition and monitoring of operational, service and diagnostics data in the feeder and process control system increases plant availability as well as maintenance and service-friendliness
- The high degree of modularity allows users to perfectly implement their plant-specific requirements for each motor feeder
- The SIMOCODE pro system offers functionally graded and space-saving solutions for each customer application
- The replacement of the control circuit hardware with integrated control functions decreases the number of hardware components and wiring required and in this way limits stock keeping costs and potential wiring errors
- The use of solid-state full motor protection permits better utilization of the motors and ensures long-term stability of the tripping characteristic and reliable tripping even after years of service

##### Multifunctional, solid-state full motor protection for rated motor currents up to 820 A

SIMOCODE pro offers comprehensive protection of the motor feeder by means of a combination of different, multi-step and delayable protection and monitoring functions:

- Inverse-time delayed solid-state overload protection (CLASS 5 to 40)
- Thermistor motor protection
- Phase failure/unbalance protection
- Stall protection
- Monitoring of adjustable limit values for the motor current
- Voltage and power monitoring
- Monitoring of the power factor (motor idling/load shedding)
- Ground-fault monitoring
- Temperature monitoring, e.g. over PT100/PT1000
- Monitoring of operating hours, downtime and number of starts etc.

##### Recording of measuring curves

SIMOCODE pro can record measuring curves and therefore is able, for example, to present the progression of motor current during motor start-up.

##### Flexible motor control implemented with integrated control functions (instead of comprehensive hardware interlocks)

Many predefined motor control functions have already been integrated into SIMOCODE pro, including all necessary logic operations and interlocks:

- Overload relays
- Direct-on-line and reversing starters
- Wye/delta starters (also with direction reversal)
- Two speeds, motors with separate windings (pole-changing switch); also with direction reversal
- Two speeds, motors with separate Dahlander windings (also with direction reversal)
- Positioner actuation
- Solenoid valve actuation
- Actuation of a circuit breaker
- Soft starter actuation (also with direction reversal)

These control functions are predefined in SIMOCODE pro and can be freely assigned to the inputs and outputs of the device (including PROFIBUS DP).

These predefined control functions can also be flexibly adapted to each customized configuration of a motor feeder by means of freely configurable logic modules (truth tables, counters, timers, edge evaluation, etc.) and with the help of standard functions (power failure monitoring, emergency start, external faults, etc.), without additional auxiliary relays being necessary in the control circuit.

SIMOCODE pro makes a lot of additional hardware and wiring in the control circuit unnecessary which results in a high level of standardization of the motor feeder in terms of its design and circuit diagrams.

##### Detailed operational, service and diagnostics data

SIMOCODE pro makes different operational, service and diagnostics data available and helps to detect potential faults in time and to prevent them by means of preventative measures. In the event of a malfunction, a fault can be diagnosed, localized and rectified very quickly – there are no or very short downtimes.

##### Operating data

- Motor switching state derived from the current flow in the main circuit
- All phase currents
- All phase voltages and phase-to-phase voltages
- Active power, apparent power and power factor
- Phase unbalance and phase sequence
- Time to trip
- Motor temperature
- Remaining cooling time etc.

##### Service data

- Motor operating hours
- Motor stop times
- Number of motor starts
- Number of overload trips
- Interval for compulsory testing of the enabling circuits
- Consumed power
- Internal comments stored in the device etc.

##### Diagnostics data

- Numerous detailed early warning and fault messages
- Internal device fault logging with time stamp
- Time stamping of freely selectable status, alarm or fault messages etc.

##### Easy operation and diagnostics

##### Operator panels

The operator panel is used to control the motor feeder and can replace all conventional pushbuttons and indicator lights to save space. It makes SIMOCODE pro or the feeder directly operable in the control cabinet. It features all the status LEDs available on the basic unit and externalizes the system interface for simple parameterization or diagnosis on a PC/PG.

##### Operator panels with display

As an alternative to the 3UF7 20 standard operator panel for SIMOCODE pro V there is also an operator panel with display: the 3UF7 21 is thus able in addition to indicate current measured values, operational and diagnostics data or status information of the motor feeder at the control cabinet. The pushbuttons of the operator panel can be used to control the motor while at the same time the display indicates current measured values, status information, fault messages or the device-internal fault protocol. Using the display settings each user can select for himself how the measured values are presented as standard and how the displayed unit is converted (e.g. °C -> °F).

# SIMOCODE 3UF motor management and control devices

## SIMOCODE pro 3UF7

General data

### Communication

SIMOCODE pro is equipped with an integral PROFIBUS DP interface (SUB-D or terminal connection) and can therefore replace all individual wiring (including marshalling racks), which would usually be required for exchanging data with the higher-level automation system, with a single 2-wire cable.

In conjunction with a fail-safe controller (F-CPU), the DM-F PROFIsafe fail-safe digital module also enables fail-safe disconnection through the same PROFIBUS with the PROFIsafe profile.

SIMOCODE pro supports among other things:

- Baud rates up to 12 Mbit/s
- Automatic baud rate detection
- Communication with up to 3 masters
- Time synchronization over PROFIBUS (SIMATIC S7)
- Time stamp with high timing precision (SIMATIC S7)
- Cyclic services (DPV0) and acyclic services (DPV1)
- DPV1 communication after the Y-Link
- Fail-safe communication through PROFIBUS/PROFIsafe in conjunction with the DM-F PROFIsafe (F-DO) fail-safe digital module etc.

For SIMOCODE pro motor management and control devices with communication function see page 3/221 onwards.

For accessories see page 3/223 onwards.

For more information see Catalog IC 10, chapter 12 "Planning, Configuration and Visualizing for SIRIUS".

For accessories for PROFIBUS DP see Catalog IK PI "Industrial Communication".

### Autonomous operation

An essential feature of SIMOCODE pro is independent execution of all protection and control functions even if communication with the I&C system breaks down. If the bus or automation system fails, the full functionality of the feeder is ensured or a pre-defined response can be initiated, e.g. the feeder can be shut down in a controlled manner or certain configured control mechanisms can be performed (e.g. the direction of rotation can be reversed).

### SIMOCODE pro designed for mixed operation

Depending on functional requirements, the two systems can be used simultaneously without any problems and without any additional outlay in a low-voltage system. SIMOCODE pro C is fully upward-compatible to SIMOCODE pro V. The same components are used. The parameterization of SIMOCODE pro C can be transferred without any problems. Both systems have the same removable terminals and the same terminal designations.

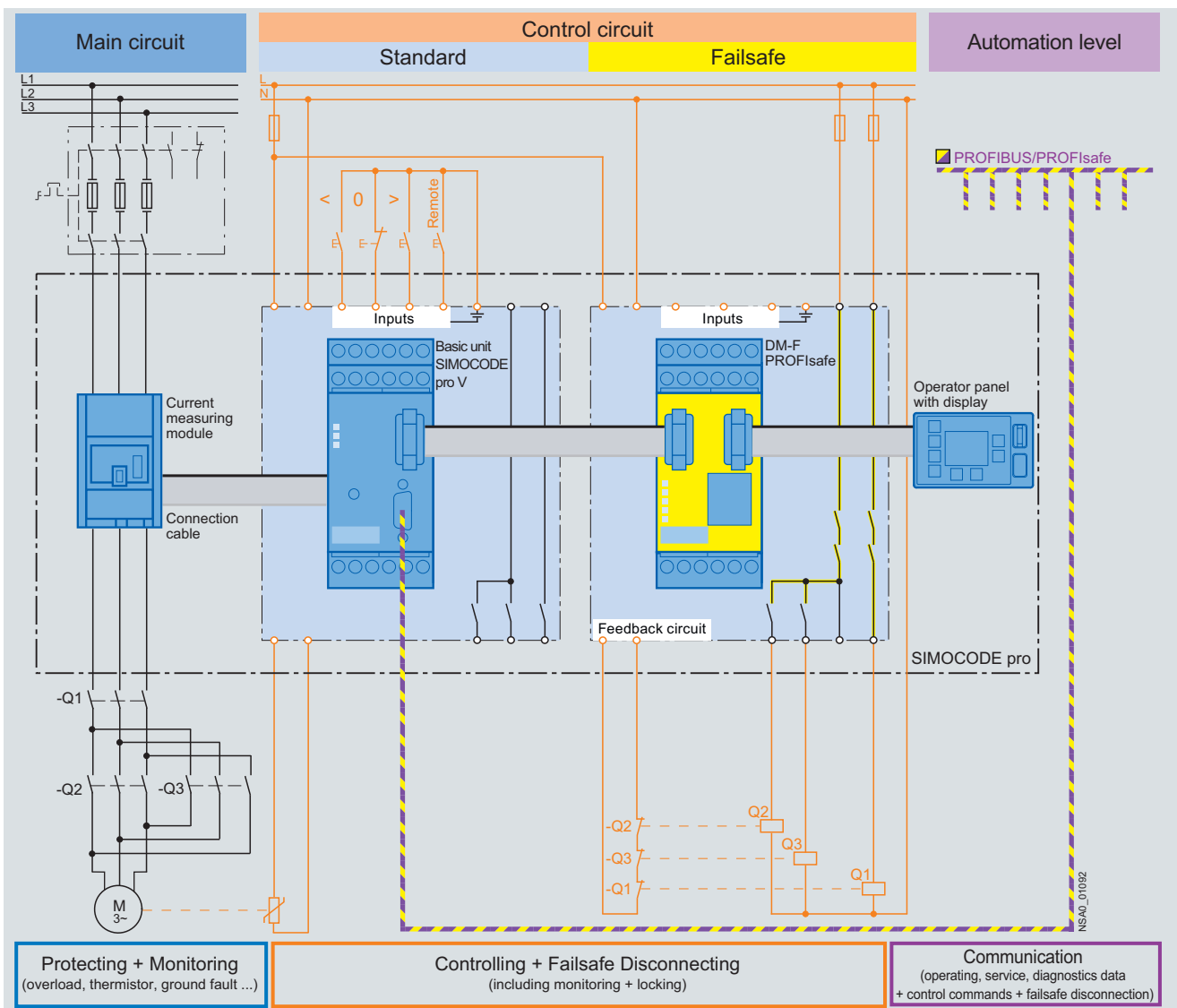

SIMOCODE pro combines all essential functions, including safety functions, through PROFIBUS/PROFIsafe for the motor feeder

3

# SIMOCODE 3UF motor management and control devices

## SIMOCODE pro 3UF7

### General data

#### Application

SIMOCODE pro is often used for automated processes where plant downtimes are very expensive (e.g. steel or cement industry) and where it is important to prevent plant downtimes through detailed operational, service and diagnostics data or to localize the fault very quickly in the event of a fault.

SIMOCODE pro is modular and space-saving and suited especially for operation in motor control centers in the process industry and for power plant technology.

#### Applications

Protection and control of motors

- In hazardous areas for types of protection EEx e/d according to ATEX directive 94/9/EC see [www.siemens.com/industrial-controls/atex](http://www.siemens.com/industrial-controls/atex)
- With heavy starting (paper, cement, metal and water industries)
- In high-availability plants (chemical, oil, raw material processing industry, power plants)

#### Safety technology for SIMOCODE pro

The safe disconnection of motors in the process industry is becoming increasingly important as the result of new and revised standards and requirements in the safety technology field.

With the DM-F Local and DM-F PROFIsafe fail-safe expansion modules it is easy to integrate functions for fail-safe disconnection in the SIMOCODE pro V motor management system while retaining service-proven concepts. The strict separation of safety functions and operational functions proves particularly advantageous for planning, configuring and construction.

Seamless integration in the motor management system leads to greater transparency for diagnostics and during operation of the system.

Suitable components for this purpose are the DM-F Local and DM-F PROFIsafe fail-safe expansion modules, depending on the requirements:

- The DM-F Local fail-safe digital module for when direct assignment between a fail-safe hardware disconnect signal and a motor feeder is required, or
- The DM-F PROFIsafe fail-safe digital module for when a fail-safe controller (F-CPU) creates the signal for the disconnection and transmits it fail-safe through PROFIBUS/PROFIsafe to the motor management system

#### Technical specifications

General data		
<b>Permissible ambient temperature</b>		
• During operation	°C	-25 ... +60 ; 3UF7 21: 0 ... +60
• Storage and transport	°C	-40 ... +80 ; 3UF7 21: -20 ... +70
<b>Degree of protection (acc. to IEC 60529)</b>		
• Measuring modules with busbar connection		IP00
• Operator panel (front) and door adapter (front) with cover		IP54
• Other components		IP20
<b>Shock resistance (sine pulse)</b>	g/ms	15/11
<b>Mounting position</b>		Any
<b>Frequency</b>	Hz	50/60 ±5 %
<b>Immunity to electromagnetic interference (acc. to IEC 60947-1)</b>		
• Line-induced interference, burst acc. to IEC 61000-4-4	kV	Corresponds to degree of severity 3
	kV	2 (power ports)
	V	1 (signal ports)
• Line-induced interference, high frequency acc. to IEC 61000-4-6		10
• Line-induced interference, surge acc. to IEC 61000-4-5	kV	2 (line to earth)
	kV	1 (line to line)
• Electrostatic discharge, ESD acc. to IEC 61000-4-2	kV	8 (air discharge)
	kV	6 (contact discharge); 3UF7 21: 4 (contact discharge)
• Field-related interference acc. to IEC 61000-4-3	V/m	10
<b>Immunity to electromagnetic interference (acc. to IEC 60947-1)</b>		
• Line-conducted and radiated interference emission		EN 55011/ EN 55022 (CISPR 11/ CISPR 22) (corresponds to degree of severity A)
<b>Protective separation (acc. to IEC 60947-1)</b>		
		All circuits in SIMOCODE pro are safely separated from each other according to IEC 60947-1, i.e. they are designed with doubled creepage paths and clearances. In this context, compliance with the instructions in the test report "Safe Isolation" No. 2668 is required.



# SIMOCODE 3UF motor management and control devices

## SIMOCODE pro 3UF7

### General data

#### Basic units

##### Control circuit

<b>Rated control supply voltage <math>U_s</math></b> (acc. to EN 61131-2)		110 ... 240 AC/DC; 50/60 Hz	24 V DC
<b>Operating range</b>		0.85 ... 1.1 × $U_s$	0.80 ... 1.2 × $U_s$
<b>Power consumption</b>			
• Basic Unit 1 (3UF7 000)		7 VA/5 W	5 W
• Basic Unit 2 (3UF7 010)		10 VA/7 W	7 W
incl. two expansion modules connected to Basic Unit 2			
<b>Rated insulation voltage <math>U_i</math></b>	V	300 (at pollution degree 3)	
<b>Rated impulse withstand voltage <math>U_{imp}</math></b>	kV	4	
<b>Relay outputs</b>			
• Number		3 monostable relay outputs	
• Specified short-circuit protection for auxiliary contacts (relay outputs)		<ul style="list-style-type: none"> <li>• Fuse links, operational class gA 6 A, quick-acting 10 A (IEC 60947-5-1)</li> <li>• Miniature circuit breaker 1.6 A, C characteristic (IEC 60947-5-1)</li> <li>• Miniature circuit breaker 6 A, C characteristic (<math>I_k &lt; 500</math> A)</li> </ul>	
• Rated uninterrupted current	A	6	
• Rated switching capacity			
		<b>AC-15</b> 6 A/24 V AC	6 A/120 V AC    3 A/230 V AC
		<b>DC-13</b> 2 A/24 V DC	0.55 A/60 V DC    0.25 A/125 V DC
<b>Inputs (binary)</b>		4 inputs supplied internally by the device electronics (with 24 V DC) and connected to a common potential	
<b>Thermistor motor protection (binary PTC)</b>			
• Summation cold resistance	kΩ	≤ 1.5	
• Response value	kΩ	3.4 ... 3.8	
• Return value	kΩ	1.5 ... 1.65	

#### Current measuring modules or current/voltage measuring modules

##### Main circuit

		3UF7 1.0	3UF7 1.1	3UF7 1.2
<b>Current setting <math>I_e</math></b>	A	0.3 ... 3	2.4 ... 25	10 ... 100
<b>Rated insulation voltage <math>U_i</math></b>	V	690; 3UF7 103 and 3UF7 104: 1000 (at pollution degree 3)		
<b>Rated operational voltage <math>U_e</math></b>	V	690		
<b>Rated impulse withstand voltage <math>U_{imp}</math></b>	kV	6; 3UF7 103 and 3UF7 104: 8		
<b>Rated frequency</b>	Hz	50/60		
<b>Type of current</b>		Three-phase current		
<b>Short-circuit</b>		Additional short-circuit protection is required in main circuit		
<b>Accuracy of current measurement (in the range of 1 x minimum current setting <math>I_u</math> to 8 x max. current setting <math>I_o</math>)</b>	%	±3		
<b>Typical voltage measuring ranges</b>				
• Phase-to-phase voltage/line-to-line-voltage (e.g. $U_{L1L2}$ )	V	110 ... 690 (only the phase voltages are available in SIMOCODE pro as measured values)		
• Phase voltage (e.g. $U_{L1}$ )	V	65 ... 400		
<b>Accuracy</b>				
• Voltage measurement (phase voltage $U_L$ in the range 230 ... 400 V)	%	±3 (typical)		
• Power factor measurement (in the rated load range p. f. = 0.4 ... 0.8)	%	±5 (typical)		
• Apparent power measurement (in the rated load range)	%	±5 (typical)		
<b>Notes on voltage measurement</b>				
• In insulated, high-resistance or asymmetrically grounded forms of power supply system and for single-phase systems		In these networks the current/voltage measuring module can be used only with an upstream decoupling module on the system interface.		
• Feeder lines for voltage measurement		In the feeder lines from the main circuit for voltage measurement of SIMOCODE pro it may be necessary to provide additional line protection!		

#### Digital modules

##### Control circuit

<b>Rated insulation voltage <math>U_i</math></b>	V	300 (at pollution degree 3)		
<b>Rated impulse withstand voltage <math>U_{imp}</math></b>	kV	4		
<b>Relay outputs</b>				
• Number		2 monostable or bistable relay outputs (depending on the version)		
• Specified short-circuit protection for auxiliary contacts (relay outputs)		<ul style="list-style-type: none"> <li>• Fuse links, operational class gG 6 A, quick-acting 10 A (IEC 60947-5-1)</li> <li>• Miniature circuit breaker 1.6 A, C characteristic (IEC 60947-5-1)</li> <li>• Miniature circuit breaker 6 A, C characteristic (<math>I_k &lt; 500</math> A)</li> </ul>		
• Rated uninterrupted current	A	6		
• Rated switching capacity				
		<b>AC-15</b> 6 A/24 V AC	6 A/120 V AC    3 A/230 V AC	
		<b>DC-13</b> 2 A/24 V DC	0.55 A/60 V DC    0.25 A/125 V DC	
<b>Inputs (binary)</b>		4 inputs, electrically isolated, supplied externally with 24 V DC or 110 ... 240 V AC/DC depending on the version, connected to a common potential		

# SIMOCODE 3UF motor management and control devices

## SIMOCODE pro 3UF7

### General data

#### Ground-fault modules

##### Control circuit

**Connectable 3UL22 summation current transformer with rated fault currents  $I_N$**

- $I_{\text{Ground fault}} \leq 50\% I_N$
- $I_{\text{Ground fault}} \geq 100\% I_N$

A 0.3/0.5/1

No tripping  
Tripping

**Response delay (conversion time)**

ms

300 ... 500, additionally delayable

#### Temperature modules

##### Sensor circuit

**Typical sensor circuits**

- PT100
- PT1000/KTY83/KTY84/NTC

mA

1 (typical)

mA

0.2 (typical)

**Open-circuit/short-circuit detection**

- For sensor type
- Open circuit
- Short-circuit
- Measuring range

PT100/PT1000

✓

✓

-50 ... +500

KTY83-110

✓

✓

-50 ... +175

KTY84

✓

✓

-40 ... +300

**Measuring accuracy at 20 °C ambient temperature (T20)**

K

&lt; ±2

**Deviation due to ambient temperature (in % of measuring range)**

%

0.05 per K deviation from T20

**Conversion time**

ms

500

**Connection type**

Two- or three-wire connection

#### Analog modules

##### Control circuit

**Inputs**

- Channels
- Parameterizable measuring ranges
- Shielding
- Max. input current (destruction limit)
- Accuracy
- Input resistance
- Conversion time
- Resolution
- Open-circuit detection

mA

2 (passive)

0/4 ... 20

Up to 30 m shield recommended, from 30 m shield required

mA

40

%

±1

 $\Omega$ 

50

ms

150

bit

12

With measuring range 4 ... 20 mA

**Output**

- Channels
- Parameterizable output range
- Shielding
- Max. voltage at output
- Accuracy
- Max. output load
- Conversion time
- Resolution
- Short-circuit proof

mA

1

0/4 ... 20

Up to 30 m shield recommended, from 30 m shield required

30 V DC

%

±1

 $\Omega$ 

500

ms

25

bit

12

Yes

**Connection type**

Two-wire connection

**Electrical separation of inputs/output to the device electronics**

No

✓ Detection possible

### More information

#### Configuration instructions when using an operator panel with display and/or a decoupling module

If you want to use an operator panel with display and/or a decoupling module in the SIMOCODE pro V system, then the following configuration instructions concerning the type and number of connectable expansion modules must be observed.

The following tables show the maximum possible configuration of the expansion modules for the various combinations.

The DM-F Local and DM-F PROFIsafe fail-safe expansion modules behave in this connection like digital modules for standard applications.

#### Use of an operator panel with display

Digital modules	Digital modules	Analog modules	Temperature modules	Ground-fault modules
<b>Only operator panel with display for basic unit 2 (24 V DC or 110 ... 240 V AC/DC)</b>				
Max. 4 expansion modules can be used				
<b>Operator panel with display and current/voltage measurement with basic unit 2 (110 ... 240 V AC/DC)</b>				
Max. 3 expansion modules can be used or:				
--	--	✓	✓	--

✓ Available

-- Not available

#### Use of a decoupling module (voltage measurement in insulated networks)

Digital modules	Digital modules	Analog modules	Temperature modules	Ground-fault modules
<b>Basic units 2 (24 V DC)</b>				
✓ <sup>1)</sup>	✓ <sup>1)</sup>	✓	✓	✓
<b>Basic unit 2 (110 ... 240 V AC/DC)</b>				
✓	✓	--	✓	✓
✓ <sup>1)</sup>	✓ <sup>1)</sup>	✓	✓	--
✓	--	✓	✓	--
✓	--	✓	--	✓

✓ Available

-- Not available

<sup>1)</sup> No bistable relay outputs and no more than 5 of 7 relay outputs active simultaneously (> 3 s).

#### Use of a decoupling module (voltage measurement in insulated networks) in combination with an operator panel with display

Digital modules	Digital modules	Analog modules	Temperature modules	Ground-fault modules
<b>Basic units 2 (24 V DC)</b>				
✓	--	✓	✓	✓
✓	✓	--	✓	✓
<b>Basic unit 2 (110 ... 240 V AC/DC)</b>				
✓ <sup>2)</sup>	--	✓	✓	✓
✓	✓	--	--	--
✓ <sup>1)</sup>	✓ <sup>1)</sup>	✓ <sup>3)</sup>	--	--
✓	--	--	✓	✓

✓ Available

-- Not available

<sup>1)</sup> No bistable relay outputs and no more than 5 of 7 relay outputs active simultaneously (> 3 s).

<sup>2)</sup> No bistable relay outputs and no more than 3 of 5 relay outputs active simultaneously (> 3 s).

<sup>3)</sup> Analog module output is not used.

#### Protective separation

All circuits in SIMOCODE pro are safely separated from each other according to IEC 60947-1, Annex N. That is, they are designed with double creepages and clearances. In the event of a fault, therefore, no parasitic voltages can be formed in neighboring circuits. The instructions of Test Report No. 2668 must be complied with.

#### Types of protection EEx e and EEx d

The overload protection and the thermistor motor protection of the SIMOCODE pro system comply with the requirements for overload protection of explosion-protected motors to the type of protection:

- EEx d "flameproof enclosure" e. g. according to EN 50018 or EN 60079-1
- EEx e "increased safety" e.g. according to EN 50019 or EN 60079-7.

When using SIMOCODE pro devices with a 24 V DC control voltage, electrical separation must be ensured using a battery or a safety transformer according to EN 61558-2-6. EC prototype test certificate: BVS 06 ATEX F 001  
Test report: BVS PP 05.2029 EG.

#### Selection data for type-tested assemblies/load feeders

Configuration tables according to type of coordination "1" or "2" can be found in the manual "SIRIUS Configuration", Order No.: E86060-T1815-A101-A3 or in the SIMOCODE pro System Manual.

#### System manual

The SIMOCODE pro system manual describes the motor management system and its functions in detail. It provides information on configuration, start-up, servicing and maintenance. A typical example of a reversing starter application is used to teach the user quickly and practically how to use the system. In addition to help on how to identify and rectify faults in the event of a malfunction, the manual also contains special information for servicing and maintenance. For selection of equipment and for configuration, it is recommended that the 3UF7 970-0AA0.-0 system manual is consulted.

A detailed description of the DM-F Local and DM-F PROFIsafe fail-safe expansion modules is provided in the system manual "SIMOCODE pro Safety Fail-safe Digital Modules", which can be downloaded from the Internet.

#### Internet

More information is available on the Internet at:







[www.siemens.com/simocode](http://www.siemens.com/simocode)

# SIMOCODE 3UF motor management and control devices

## SIMOCODE pro 3UF7

### Basic units

#### Selection and ordering data

Version	Current setting	Width	DT	Screw terminals	Order No.		
	A	mm					
<b>SIMOCODE pro</b>							
	<b>SIMOCODE pro C, Basic Unit 1</b> PROFIBUS DP interface, 12 Mbit/s, RS 485 4 I/3 O freely assignable, input for thermistor connection, monostable relay outputs, rated control supply voltage $U_s$ : • 24 V DC • 110 ... 240 V AC/DC			A A	<b>3UF7 000-1AB00-0</b> <b>3UF7 000-1AU00-0</b>		
3UF7 000-1A.00-0							
	<b>SIMOCODE pro V, Basic Unit 2</b> PROFIBUS DP interface, 12 Mbit/s, RS 485 4 I/3 O freely assignable, input for thermistor connection, monostable relay outputs, can be expanded by expansion modules, rated control supply voltage $U_s$ : • 24 V DC • 110 ... 240 V AC/DC			A A	<b>3UF7 010-1AB00-0</b> <b>3UF7 010-1AU00-0</b>		
3UF7 010-1A.00-0							
	<b>Current measuring modules</b> • Straight-through transformers • Busbar connections			0.3 ... 3 2.4 ... 25 10 ... 100 20 ... 200 20 ... 200 63 ... 630	45 45 55 120 120 145	A A A A A A	<b>3UF7 100-1AA00-0</b> <b>3UF7 101-1AA00-0</b> <b>3UF7 102-1AA00-0</b> <b>3UF7 103-1AA00-0</b> <b>3UF7 103-1BA00-0</b> <b>3UF7 104-1BA00-0</b>
3UF7 100-1AA00-0							
	<b>Current/voltage measuring modules for SIMOCODE pro V</b> Voltage measuring up to 690 V if required in connection with a decoupling module • Straight-through transformers • Busbar connections			0.3 ... 3 2.4 ... 25 10 ... 100 20 ... 200 20 ... 200 63 ... 630	45 45 55 120 120 145	A A A A A A	<b>3UF7 110-1AA00-0</b> <b>3UF7 111-1AA00-0</b> <b>3UF7 112-1AA00-0</b> <b>3UF7 113-1AA00-0</b> <b>3UF7 113-1BA00-0</b> <b>3UF7 114-1BA00-0</b>
3UF7 110-1AA00-0							
	<b>Decoupling modules</b> For connecting upstream from a current/voltage measuring module on the system interface when using voltage detection in insulated, high-resistance or asymmetrically grounded systems and in single-phase systems			A	<b>3UF7 150-1AA00-0</b>		
3UF7 150-1AA00-0							
	<b>Operator panels</b> Installation in control cabinet door or front plate, for plugging into basic unit, 10 LEDs for status indication and user-assignable buttons for controlling the motor			A	<b>3UF7 200-1AA00-0</b>		
3UF7 200-1AA00-0							
	<b>Operator panels with display for SIMOCODE pro V<sup>1)</sup></b> Installation in control cabinet door or front plate, for plugging into basic unit 2, 7 LEDs for status indication and user-assignable buttons for controlling the motor, multilingual display, e.g. for indication of measured values, status information or fault messages			▶	<b>3UF7 210-1AA00-0</b>		
3UF7 210-1AA00-0							

<sup>1)</sup> Only possible with basic unit 2, product version E03 and higher (from 12/2006).

## Selection and ordering data

Version	DT	<b>Screw terminals</b>	
		Order No.	

## Expansion modules for SIMOCODE pro V

With SIMOCODE pro V, it is possible to expand the type and number of inputs and outputs in steps. Each expansion module has two system interfaces on the front. Through the one system interface the expansion module is connected to the system interface of the SIMOCODE pro V using a connection cable; through the second system interface, further expansion modules or the operator panel can be connected. The power supply for the expansion modules is provided by the connection cable through Basic Unit 2.

Note:

*Please order connection cable separately, see page 3/223.*

**Digital modules**

Up to two digital modules can be used to add additional binary inputs and relay outputs to basic unit. The input circuits of the digital modules are supplied from an external power supply.

4 binary inputs and 2 relay outputs,  
up to 2 digital modules can be connected per basic unit 2

Relay outputs	Input voltage		
Monostable	24 V DC	A	<b>3UF7 300-1AB00-0</b>
	110 ... 240 V AC/DC	A	<b>3UF7 300-1AU00-0</b>
Bistable	24 V DC	A	<b>3UF7 310-1AB00-0</b>
	110 ... 240 V AC/DC	A	<b>3UF7 310-1AU00-0</b>

**Analog modules**

Basic unit can be optionally expanded with analog inputs and outputs (0/4 ... 20 mA) by means of the analog module.

2 inputs (passive) for input and 1 output for output of 0/4 ... 20 mA signals, max. 1 analog module can be connected per Basic Unit 2.

**Ground-fault modules**

Instead of ground-fault monitoring using the current measuring modules or current/voltage measuring modules, it may be necessary, especially in high-impedance grounded networks, to implement ground-fault monitoring for smaller ground fault currents using a summation current transformer.

1 input for connecting a summation current transformer 3UL22, up to 1 ground-fault module can be connected per Basic Unit 2

Note:

*For corresponding summation current transformers for rated fault currents of 0.3 A, 0.5 A or 1 A see Catalog IC 10, page 8/19.*

**Temperature modules**

Independently of the thermistor motor protection of the basic units, up to 3 analog temperature sensors can be evaluated using a temperature module.

Sensor types: PT100/PT1000, KTY83/KTY84 or NTC

3 inputs for connecting up to 3 analog temperature sensors, up to 1 temperature module can be connected per Basic Unit 2



3UF7 300-1AU00-0



3UF7 400-1AA00-0



3UF7 500-1AA00-0



3UF7 700-1AA00-0

# SIMOCODE 3UF motor management and control devices

## SIMOCODE pro 3UF7

### Fail-safe expansion modules

#### Selection and ordering data

Version	DT	<b>Screw terminals</b> 
		Order No.

#### Fail-safe expansion modules for SIMOCODE pro V

Thanks to the fail-safe expansion modules, SIMOCODE pro V can be expanded with the function of a safety relay for the fail-safe disconnection of motors. A maximum of 1 fail-safe digital module can be connected; it can be used instead of a digital module.

The fail-safe expansion modules are equipped likewise with two system interfaces at the front for making the connection to other system components. Unlike other expansion modules, power is supplied to the modules through a separate terminal connection.

Note:

Please order connection cable separately, see page 3/223.

#### DM-F Local fail-safe digital modules

For fail-safe disconnection using a hardware signal  
2 relay enabling circuits, joint switching; 2 relay outputs, common potential disconnected fail-safe; inputs for sensor circuit, start signal, cascading and feedback circuit, safety function adjustable using DIP switches, rated control supply voltage  $U_S$ :

- 24 V DC
- 110 ... 240 V AC/DC

A

**3UF7 320-1AB00-0**

A

**3UF7 320-1AU00-0**

3UF7 320-1AB00-0

#### DM-F PROFIsafe fail-safe digital modules

For fail-safe disconnection using PROFIBUS/PROFIsafe  
2 relay enabling circuits, joint switching; 2 relay outputs, common potential disconnected fail-safe; 1 input for feedback circuit; 3 binary standard inputs, rated control supply voltage  $U_S$ :

- 24 V DC
- 110 ... 240 V AC/DC

A







**3UF7 330-1AB00-0**

A

**3UF7 330-1AU00-0**

3UF7 330-1AB00-0



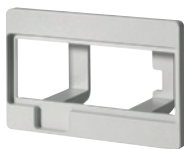



### Selection and ordering data

Version	DT	Order No.
<b>Connection cables (essential accessory)</b>		
 <p>3UF7 932-0AA00-0</p> <p><b>Connection cables</b> In different lengths for connecting basic unit, current measuring module, current/voltage measuring module, operator panel or expansion modules or decoupling module:</p> <ul style="list-style-type: none"> <li>• Length 0.025 m (flat)</li> <li>• Length 0.1 m (flat)</li> <li>• Length 0.3 m (flat)</li> <li>• Length 0.5 m (flat)</li> <li>• Length 0.5 m (round)</li> <li>• Length 1.0 m (round)</li> <li>• Length 2.5 m (round)</li> </ul>	A	3UF7 930-0AA00-0
	A	3UF7 931-0AA00-0
	A	3UF7 935-0AA00-0
	A	3UF7 932-0AA00-0
	A	3UF7 932-0BA00-0
	A	3UF7 937-0BA00-0
	A	3UF7 933-0BA00-0
<b>PC cables and adapters</b>		
 <p>3UF7 940-0AA00-0</p> <p><b>For PC/PG communication with SIMOCODE pro</b> Through the system interface, for connecting to the serial interface of the PC/PG</p>	A	3UF7 940-0AA00-0
 <p>3UF7 946-0AA00-0</p> <p><b>USB/serial adapters</b> To connect an RS 232 PC cable to the USB port of a PC, we recommend using modular safety system 3RK3, soft starter 3RW44, ET 200S/ECOFAS/ET 200pro motor starter, AS-i safety monitor, AS-i analyzer in conjunction with SIMOCODE pro 3UF7</p>	B	3UF7 946-0AA00-0
<b>Memory modules</b>		
 <p>3UF7 900-0AA00-0</p> <p>The memory module enables the complete parameter assignment of a system to be saved and transferred to a new system, e.g. when a device is replaced, without the need for additional aids or detailed knowledge of the the system interface</p>	A	3UF7 900-0AA00-0
<b>Interface covers</b>		
 <p>3UF7 950-0AA00-0</p> <p><b>For system interface</b></p>	A	3UF7 950-0AA00-0
<b>Addressing plugs</b>		
 <p>3UF7 910-0AA00-0</p> <p><b>For assigning the PROFIBUS addresses without using a PC or programming device</b> On SIMOCODE pro through the system interface</p>	A	3UF7 910-0AA00-0
<b>Door adapters</b>		
 <p>3UF7 920-0AA00-0</p> <p><b>For external connection of the system interface</b> Outside, for example, a control cabinet</p>	A	3UF7 920-0AA00-0
<b>Adapters for operator panel</b>		
 <p>3UF7 922-0AA00-0</p> <p>The adapter enables the smaller 3UF7 20 operator panel from SIMOCODE pro to be used in a front panel cutout in which previously, e.g. after a change of system, a larger 3UF5 2 operator panel from SIMOCODE-DP had been used; degree of protection IP54</p>	A	3UF7 922-0AA00-0

# SIMOCODE 3UF motor management and control devices

## SIMOCODE pro 3UF7

### Accessories

Version	DT	Order No.	
<b>Labeling strips</b>			
 <p>3UF7 925-0AA02-0</p>	• For pushbuttons of the 3UF7 20 operator panel	A	<b>3UF7 925-0AA00-0</b>
	• For pushbuttons of the 3UF7 21 operator panel with display	A	<b>3UF7 925-0AA01-0</b>
	• For LEDs of the 3UF7 20 operator panel	A	<b>3UF7 925-0AA02-0</b>
	<p><u>Note:</u> Pre-punched labeling strips for user-specific printing using the free inscription software "SIRIUS Label Designer" on a laser printer. Note the software version! Download from <a href="http://www.siemens.com/simocode">www.siemens.com/simocode</a></p>		
<b>Push-in lugs</b>			
 <p>3RB19 00-0B</p>	<p><b>For screw fixing</b> E.g. on mounting plate, 2 units required per device</p> <ul style="list-style-type: none"> <li>• Can be used with 3UF7 1.0, 3UF7 1.1 and 3UF7 1.2</li> <li>• Can be used with 3UF7 0, 3UF7 3, 3UF7 4, 3UF7 5 and 3UF7 7</li> </ul>	A	<b>3RB19 00-0B</b>
		▶	<b>3RP19 03</b>
<b>Terminal covers</b>			
 <p>3RT19 56-4EA1</p>	<p><b>Covers for cable lugs and busbar connections</b></p> <ul style="list-style-type: none"> <li>• Length 100 mm, can be used for 3UF7 1.3-1BA00-0</li> <li>• Length 120 mm, can be used for 3UF7 1.4-1BA00-0</li> </ul>	▶	<b>3RT19 56-4EA1</b>
		▶	<b>3RT19 66-4EA1</b>
 <p>3RT19 56-4EA2</p>	<p><b>Covers for box terminals</b></p> <ul style="list-style-type: none"> <li>• Length 25 mm, can be used for 3UF7 1.3-1BA00-0</li> <li>• Length 30 mm, can be used for 3UF7 1.4-1BA00-0</li> </ul>	▶	<b>3RT19 56-4EA2</b>
		▶	<b>3RT19 66-4EA2</b>
 <p>3RT19 56-4EA3</p>	<p><b>Covers for screw terminals</b> Between contactor and current measuring module or current/voltage measuring module for direct mounting</p> <ul style="list-style-type: none"> <li>• Can be used for 3UF7 1.3-1BA00-0</li> <li>• Can be used for 3UF7 1.4-1BA00-0</li> </ul>	▶	<b>3RT19 56-4EA3</b>
		▶	<b>3RT19 66-4EA3</b>
<b>Box terminal blocks</b>			
 <p>3RT19 5.-4G</p>	For round and ribbon cables		
	• Up to 70 mm <sup>2</sup> , can be used for 3UF7 1.3-1BA00-0	▶	<b>3RT19 55-4G</b>
	• Up to 120 mm <sup>2</sup> , can be used for 3UF7 1.3-1BA00-0	▶	<b>3RT19 56-4G</b>
	• Up to 240 mm <sup>2</sup> , can be used for 3UF7 1.4-1BA00-0	▶	<b>3RT19 66-4G</b>
<p><i>For conductor cross-sections see Catalog IC 10, page 8/1.</i></p>			
<b>Bus termination modules</b>			
	With separate supply voltage for terminating the bus following the last unit on the bus line. Supply voltage:		
	• 115/230 V AC	C	<b>3UF1 900-1KA00</b>
	• 24 V DC	C	<b>3UF1 900-1KB00</b>
<b>System manuals</b>			
 <p>3UF7 970-0AA01-0</p>	<p><b>SIMOCODE pro</b> With token fee, languages:</p> <ul style="list-style-type: none"> <li>• German</li> <li>• English</li> <li>• French</li> </ul>	A	<b>3UF7 970-0AA01-0</b>
		A	<b>3UF7 970-0AA00-0</b>
		A	<b>3UF7 970-0AA02-0</b>
	<p><u>Note:</u> The system manual "SIMOCODE pro Safety Fail-safe Digital Modules" is available on the Internet at <a href="http://www.siemens.com/simocode">www.siemens.com/simocode</a>.</p>		



# SIMOCODE 3UF motor management and control devices

## SIMOCODE pro 3UF7

### Accessories

Version	DT	Order No.
---------	----	-----------

#### SIMOCODE ES 2007 Basic



##### Floating license for one user

E-SW, software and documentation on CD, 3 languages (German/English/French), communication through system interface

- License key on USB stick, Class A
- License key download, Class A

- ▶ **3ZS1 312-4CC10-0YA5**
- ▶ **3ZS1 312-4CE10-0YB5**

3ZS1 312-4CC10-0YA5

#### SIMOCODE ES 2007 Standard

##### Floating license for one user

E-SW, software and documentation on CD, 3 languages (German/English/French), communication through system interface, integrated graphics editor

- License key on USB stick, Class A
- License key download, Class A

- ▶ **3ZS1 312-5CC10-0YA5**
- ▶ **3ZS1 312-5CE10-0YB5**

##### Upgrade for SIMOCODE ES 2004 and later

- ▶ **3ZS1 312-5CC10-0YE5**

Floating license for one user, E-SW, software and documentation on CD, license key on USB stick, Class A, 3 languages (German/English/French), communication through the system interface

##### Powerpack for SIMOCODE ES 2007 Basic

- ▶ **3ZS1 312-5CC10-0YD5**

Floating license for one user, E-SW, license key on USB stick, Class A, 3 languages (German/English/French), communication through the system interface

##### Software Update Service

- ▶ **3ZS1 312-5CC10-0YL5**

For 1 year with automatic extension, assuming the current software version is in use, E-SW, software and documentation on CD, communication through the system interface

#### SIMOCODE ES 2007 Premium

##### Floating license for one user

E-SW, software and documentation on CD, 3 languages (German/English/French), communication through PROFIBUS or system interface, integrated graphics editor, STEP7 Object Manager

- License key on USB stick, Class A
- License key download, Class A

- ▶ **3ZS1 312-6CC10-0YA5**
- ▶ **3ZS1 312-6CE10-0YB5**

##### Upgrade for SIMOCODE ES 2004 and later

- ▶ **3ZS1 312-6CC10-0YE5**

Floating license for one user, E-SW, software and documentation on CD, license key on USB stick, Class A, 3 languages (German/English/French), communication through PROFIBUS or the system interface

##### Powerpack for SIMOCODE ES 2007 Standard

- ▶ **3ZS1 312-6CC10-0YD5**

Floating license for one user, E-SW, license key on USB stick, Class A, 3 languages (German/English/French), communication through the PROFIBUS or the system interface

##### Software Update Service

- ▶ **3ZS1 312-6CC10-0YL5**

For 1 year with automatic extension, assuming the current software version is in use, E-SW, software and documentation on CD, communication through PROFIBUS or the system interface

Please order PC cable separately, see page 3/223.

#### Note:

For more information see Catalog IC 10, chapter 12 "Planning, Configuration and Visualizing for SIRIUS".

# SIMOCODE 3UF motor management and control devices

## SIMOCODE pro 3UF7

### Accessories

Version	DT	Order No.	
<b>SIMOCODE pro function block library for SIMATIC PCS 7</b>			
 <p>3UF7 982-0AA00-0</p>	Scope of supply: AS modules and faceplates for integrating SIMOCODE pro into the PCS 7 process control system		
	<b>Engineering software</b> for one engineering station (single license) including runtime software for execution of the AS module in an automation system (single license), German/English/French, Type of delivery: CD incl. electronic documentation		
	• For PCS 7 Version V 6.0	A	<b>3UF7 982-0AA00-0</b>
	• For PCS 7 Version V 6.1	A	<b>3UF7 982-0AA02-0</b>
• For PCS 7 Version V 7.0	A	<b>3UF7 982-0AA10-0</b>	
<b>Runtime software</b> For execution of the AS module in an automation system (single license), Type of delivery: license without software and documentation			
• For PCS 7 Version V 6.x	A	<b>3UF7 982-0AA01-0</b>	
• For PCS 7 Version V 7.x	A	<b>3UF7 982-0AA11-0</b>	
<b>Upgrade for the PCS 7 function block library SIMOCODE pro, V6.0 or V6.1 on Version SIMOCODE pro V7.0</b> for integrating SIMOCODE pro into the PCS 7 process control system, for PCS 7 Version V7.0 (single license), German/English/French, Type of delivery: CD incl. electronic documentation		A	<b>3UF7 982-0AA13-0</b>

Note:

For more information see Catalog IC 10, chapter 12 "Planning, Configuration and Visualizing for SIRIUS".

# Reacting



## Delivery time classes (DT)

▶ Preferred type	Preferred types are available immediately from stock, i.e. are dispatched within 24 hours.
A 2 work days	
B 1 week	
C 3 weeks	In exceptional cases the actual delivery time may differ from that specified
D 6 weeks	
X on request	

The transport times depend on the destination and type of shipping. The standard transport time for Germany is 1 day.

The delivery times shown represent the state of 10/2010.

4/2	<b>SIRIUS Industrial Controls</b>	4/66	<b>SINAMICS G120D - Distributed inverters 0.75 kW to 7.5 kW</b>
4/4	<b>ET 200S – Safety motor starters and frequency converter solutions local / PROFIsafe</b>	4/70	CU240D Control units
4/5	<b>ET 200S – Safety motor starters</b>	4/74	MMC memory card
4/6	Standard motor starters	4/75	PM250D Power modules
4/7	Standard terminal modules	4/77	<b>SINAMICS G130 chassis units 75 kW to 800 kW</b>
4/8	High-Feature motor starters	4/80	<b>SINAMICS G150 Drive converter cabinet units 75 kW to 1500 kW</b>
4/9	ET 200S Fail-safe motor starters	4/82	<b>SINAMICS S110 - Single-axis drives 0.12 kW to 90 kW</b>
4/11	Terminal module Fail-safe	4/84	CU305 Control unit
4/12	Safety modules local and PROFIsafe	4/87	Power modules
4/18	Safety modules local and PROFIsafe terminal modules	4/93	Line reactors/Line filters
4/20	Accessories for Standard and High Feature motor starters	4/94	Braking resistors
4/24	<b>ET 200S FC fail-safe frequency converter</b>	4/96	BOP20 Basic Operator Panel
4/29	<b>ET 200S – Software</b>	4/97	<b>SINAMICS S120 - Modular drive system 0.12 kW to 4500 kW</b>
4/29	Motor Starter ES (STARTER Commissioning tool: See page 4/65)	4/101	Cabinet modules
4/32	<b>ET 200pro – Motor starters and frequency converters</b>	4/103	CU310 DP Control unit
4/32	ET 200pro motor starters	4/104	CU310 PN Control unit
4/34	Standard motor starters and High-Feature motor starters	4/109	CompactFlash Card for CU310
4/35	Safety local isolator module, F-switch PROFIsafe	4/110	CU320-2 DP Control unit
4/38	Accessories for motor starters ET 200pro	4/113	CompactFlash Card for CU320-2
4/41	ET 200pro FC frequency converter	4/114	TM54F Terminal module
4/45	<b>SINAMICS Introduction</b>	4/117	<b>SINAMICS S150 - Drive converter cabinet units 75 kW to 1200 kW</b>
4/49	<b>SINAMICS Safety Integrated</b>	4/119	<b>CNC automation system SINUMERIK</b>
4/54	... for SINAMICS G120 and SINAMICS G120D	4/119	Safety Integrated for SINUMERIK 840D and SINUMERIK 840D sl
4/57	... for SINAMICS G130 and SINAMICS G150	4/122	Safety Integrated for SINUMERIK 828D
4/58	... for SINAMICS S110		
4/60	... for SINAMICS S120		
4/63	... for SINAMICS S150		
4/64	<b>Engineering tools for SINAMICS</b>		
4/64	SIZER configuration tool		
4/65	STARTER commissioning tool		

## SINAMICS G120

See Catalog D31 • 2012

# SIRIUS Industrial Controls

**High demands are made in the field of industrial controls: Users want cost-effective solutions which can be easily integrated in control cabinets, distribution boards and distributed systems and which can communicate perfectly with each other.**

**Our response to their demands are SIRIUS industrial controls.**

The SIRIUS range has everything you need for switching, protecting and starting loads. Products for monitoring, control, detection, commanding, signaling and power supply round off the spectrum of industrial controls.

Building control cabinets should be quick, easy, flexible and space-saving. But how can all these requirements be met simultaneously? The answer lies in the unique SIRIUS modular system up to 250 kW / 400 V, where you will find everything that you need for switching, protecting and starting motors and industrial systems.

Furthermore, all components of the SIRIUS modular system are characterized by a space-saving design and high flexibility and are optimally coordinated with each other. Configuring, installing, wiring and maintenance are extremely easy and time-saving to perform.

Regardless of whether you want to build up your own load feeders with motor starter protectors/circuit breakers or overload relays, contactors or soft starters, or decide instead in favor of preassembled feeders: SIRIUS has the right product for every application.

Continuous further development and regular innovations ensure that our customers are optimally equipped with SIRIUS and benefit from efficient solutions – today and tomorrow.

## Systematic further development – SIRIUS Innovations

SIRIUS has long been synonymous world-wide with industrial controls and has been a trendsetter in this field from the very beginning. The SIRIUS modular system with its components for the switching, starting, protection and monitoring of motors and industrial systems stands for the fast, flexible and space-saving construction of control cabinets.

With its latest innovations for the main and control circuit, the new SIRIUS modular system has underlined its leading position once again.

The consistent further development of SIRIUS takes even better account of current market requirements, particularly the call for fewer variants, greater flexibility and reduced cost and time. The advantages for you are: higher productivity and cost efficiency in your company.



## Clicking replaces wiring

In the portfolio of the SIRIUS modular system you can trust on finding perfectly coordinated and flexibly combinable components which now are even easier to install: plug in place, connect, click and that's it! Complicated wiring is a thing of the past, as are wiring errors. For you this means a significant reduction of time and cost.

## Innovative through and through

The SIRIUS modular system in sizes S00 and S0 up to 40 A has been completely revised – with respect to the main and control circuit. As the result, the innovative basic components such as circuit breakers and contactors provide a host of advantages to optimize your plant, today and in the future. Often the innovation is to be found in the details. For example, more power in the same design and the bundling of functions in basic devices for notable space savings.



At the same time the innovations enable the greatest flexibility. Be it direct starting, reverse starting or wye-delta starting for customer assembly, as a tested combination or an "all-in-one" solution complete with the compact starter, for soft starting or for frequent switching: the SIRIUS modular system offers the perfect answer.

Another aspect at the focus of the new developments was the enhancement of plant availability. In future, SIRIUS components from the modular system can also be used at minimum expense to monitor the application. Selective plant monitoring then becomes utterly simple – with current monitoring relays integrated directly in the load feeder or configured from the controller via the load feeder connection to AS-Interface or IO-Link.

These innovations are the perfect low-end supplement to today's S2-S12 modular system up to 250 kW / 400 V and offer many new options for the construction of control cabinets.

#### More efficiency in control cabinet installation

The highlights of the new SIRIUS modular system are particularly numerous with regard to assembly and handling, application monitoring, connection to the controller, and customer support throughout the plant's service life.

All these innovations add up to the many different possibilities of the new SIRIUS modular system as a whole – for the highest efficiency in control cabinet installation.

### SIRIUS Safety Integrated

Combined with Totally Integrated Automation and Safety Integrated, our product portfolio can be bundled to create optimized systems. All in all, Siemens provides innovative controls with modern features, such as integrated communication and safety technology that work to your advantage: the basis for ground-breaking integrated solutions.

Safety Integrated by Siemens is the consistent implementation of safety technology in accordance with the concept of Totally Integrated Automation. Direct integration of safety-related functions in our standard products and the consistent integration of safety concepts in the standard automation environment offer many advantages for machine manufacturers and system operators.

Our SIRIUS Safety Integrated controls are a central element of the Siemens Safety Integrated concept. Whether for fail-safe detecting, controlling and signaling, monitoring and evaluating or starting and reliable shutting down – our SIRIUS Safety Integrated controls are expert at performing safety tasks in your plant.

SIRIUS Safety Integrated uses fail-safe communication via standard field bus systems, e. g. ASIsafe via AS-Interface and PROFIsafe via PROFIBUS, to solve even networked safety tasks of greater complexity. This opens the door for flexible safety solutions for compact machines or large-scale plants in compliance with the Machinery Directive up to SIL 3 / PL e.

**More information on SIRIUS Industrial Controls, e.g. on contactors and safety relays, is provided in Catalog IC 10.**



# SIMATIC ET 200S distributed IOs

## ET 200S Safety motor starters and frequency converter solutions local/PROFIsafe

### Introduction

### Overview

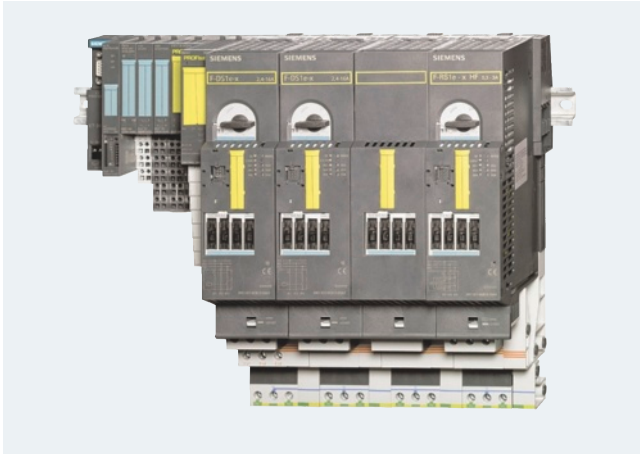

The ET 200S Safety motor starters solutions comprise:

- Safety modules
- Standard motor starters
- High-Feature motor starters
- Fail-safe motor starters

With the ET 200S Solutions safety motor starters there is no complicated and hence cost-intensive configuring and wiring compared to the conventional safety systems. The ET 200S Solutions safety motor starters are designed for Category 4 according to EN 954-1 or SIL 3 IEC 61508.

They enable the use of safety-oriented direct-on-line starters or reversing starters in the SIMATIC ET 200S distributed peripherals system on PROFINET or PROFIBUS. The fine modular architecture of the system permits optimum imaging of machine or plant applications.

Within an ET 200S station the Solutions safety motor starters can also be combined with Standard motor starters or High Feature motor starters without safety functions or the SIMATIC ET 200S FC frequency converters up to max. 4 kW up to Category 3 according to EN 954-1 or SIL 2 according to IEC 61508.

Standard and High Feature ET 200S motor starters can be found in catalog IK PI.

The "SIMATIC ET 200S Configurator" software allows you to quickly and efficiently select the appropriate SIMATIC hardware. The "SIMATIC ET 200S Configurator" software is available in the Siemens Industry Mall, the ordering and information platform in the Internet:

<http://www.siemens.com/industrymall>

Then select "Configurators" / "SIMATIC ET 200S Configurator".

**Note:**  
for safety characteristics, see catalog appendix.



Frequency converter ET 200S FC Fail-safe

#### Fail-safe frequency converter

- For the continuous speed control of asynchronous motors
- Comprising modules for the ICU24F control module and IPM25 power section up to 4.0 kW
- Hot swapping of control module and power section is permissible
- Operation without line commutation reactor
- Active braking with line-commutated power recovery
- Can be combined with brake control module for actuating an electromechanical holding brake
- To achieve EMC class A (according to EN 55011), connection of an EMC filter upstream from the power bus

The ET 200S FC fail-safe version provides extensive integrated safety functions (certified according to EN 954-1 (Kat. 3), IEC 61508 (SIL 2) and ISO 13849-1 (PL d))

- Safe torque off torque (STO, Safe Torque Off) to guard against any active movement of the operating mechanism
- Safely limited speed (SLS, Safely Limited Speed) to guard against danger from movements caused when a limit speed is exceeded
- Safe stop 1 (SS1, Safe Stop 1) for continuous monitoring of a safe brake ramp

Both the "Safe Stop 1" function and the "Safely Limited Speed" function operate without motor sensor or encoder; the implementation cost is minimal. Existing systems in particular can be retrofitted with safety technology without the motor or mechanics having to be modified.

The "Safely Limited Speed" and "Safe Stop 1" safety functions are not approved for drawing loads such as lifting devices and unwinders.

### Applications

**For operation in a control cabinet**  
**ET 200S Safety motor starters Solutions local/PROFIsafe**

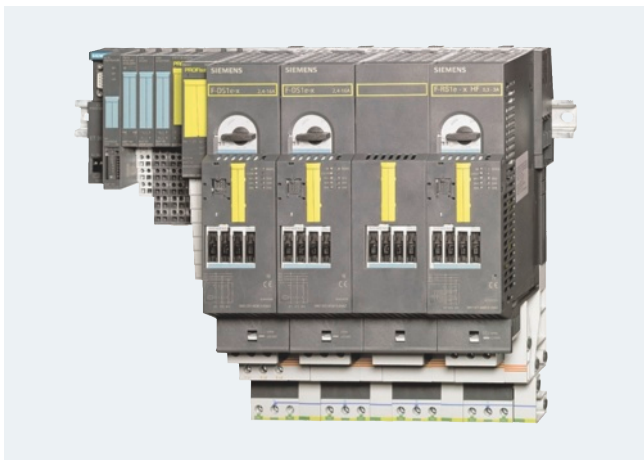

The ET 200S Safety motor starter Solutions are preferred in all production and process automation fields in which the enhancement of plant availability and flexibility plays a key role.

- **Safety motor starters Solutions local** are preferred from the safety technology point of view for locally restricted safety applications. These motor starters are not dependent on a safe control system.
- **Safety motor starters Solutions PROFIsafe** are often found by contrast in safety applications of the more complex type that are interlinked. In this case a safe control system is used with the bus systems PROFINET or PROFIBUS with the PROFIsafe profile.

The ET 200S Safety motor starters Solutions comprise:

- Safety modules
- Standard motor starters
- High-Feature motor starters
- Fail-safe motor starters

With the ET 200S Solutions safety motor starters there is no complicated and hence cost-intensive configuring and wiring compared to the conventional safety systems. The ET 200S Solutions safety motor starters are designed for Category 4 according to EN 954-1 or SIL 3 IEC 61508.

They enable the use of safety-oriented direct-on-line starters or reversing starters in the SIMATIC ET 200S distributed peripherals system on PROFINET or PROFIBUS. The fine modular architecture of the system permits optimum imaging of machine or plant applications.

Within an ET 200S station the Solutions safety motor starters can also be combined with Standard motor starters or High Feature motor starters without safety functions or the SIMATIC ET 200S FC frequency converters up to max. 4 kW up to Category 3 according to EN 954-1 or SIL 2 according to IEC 61508.

The "SIMATIC ET 200S Configurator" software allows you to quickly and efficiently select the appropriate SIMATIC hardware. The "SIMATIC ET 200S Configurator" software is available in the Siemens Industry Mall, the ordering and information platform in the Internet:

<http://www.siemens.com/industrymall>

Then select "Configurators" / "SIMATIC ET 200S Configurator".

Note:  
for safety characteristics, see catalog appendix.

### Motor Starter ES software

The Motor Starter ES software is used for the parameterization, monitoring, diagnostics and testing of motor starters.  
 See page 4/29.

### SIRIUS Motor Starter Function Block Library for SIMATIC PCS 7

With the SIRIUS motor starter PCS 7 function block library, SIRIUS ET 200S motor starters (direct and reversing starters, direct-on-line soft starters) can be easily and simply integrated into the SIMATIC PCS 7 process control system. The SIRIUS motor starter PCS 7 function block library contains the diagnostics and driver blocks corresponding to the SIMATIC PCS 7 diagnostics and driver concept as well as the elements (symbols and faceplates) required for operator control and process monitoring.

See Catalog IC 10, chapter 12 "Planning, Configuration and Visualizing for SIRIUS".

# SIMATIC ET 200S distributed IOs

## ET 200S Safety motor starters

### Standard motor starters

#### Selection and ordering data

Induction motor 4-pole at 400 V AC, standard output <i>P</i>	Setting range of the electronic release	DT	Order No.
kW	A		

Standard motor starters,  
with diagnostics, electromechanical, fuseless,  
expandable with brake control module

#### *DS1-x direct-on-line starters*

< 0.06	0.14 ... 0.20	A	<b>3RK1 301-0BB00-0AA2</b>
0.06	0.18 ... 0.25	A	<b>3RK1 301-0CB00-0AA2</b>
0.09	0.22 ... 0.32	A	<b>3RK1 301-0DB00-0AA2</b>
0.10	0.28 ... 0.40	A	<b>3RK1 301-0EB00-0AA2</b>
0.12	0.35 ... 0.50	A	<b>3RK1 301-0FB00-0AA2</b>
0.18	0.45 ... 0.63	A	<b>3RK1 301-0GB00-0AA2</b>
0.21	0.55 ... 0.80	A	<b>3RK1 301-0HB00-0AA2</b>
0.25	0.70 ... 1.00	A	<b>3RK1 301-0JB00-0AA2</b>
0.37	0.90 ... 1.25	A	<b>3RK1 301-0KB00-0AA2</b>
0.55	1.1 ... 1.6	A	<b>3RK1 301-1AB00-0AA2</b>
0.75	1.4 ... 2.0	A	<b>3RK1 301-1BB00-0AA2</b>
0.90	1.8 ... 2.5	A	<b>3RK1 301-1CB00-0AA2</b>
1.1	2.2 ... 3.2	A	<b>3RK1 301-1DB00-0AA2</b>
1.5	2.8 ... 4.0	A	<b>3RK1 301-1EB00-0AA2</b>
1.9	3.5 ... 5.0	A	<b>3RK1 301-1FB00-0AA2</b>
2.2	4.5 ... 6.3	A	<b>3RK1 301-1GB00-0AA2</b>
3.0	5.5 ... 8.0	A	<b>3RK1 301-1HB00-0AA2</b>
4.0	7 ... 10	A	<b>3RK1 301-1JB00-0AA2</b>
5.5	9 ... 12	A	<b>3RK1 301-1KB00-0AA2</b>

#### *RS1-x reversing starters*

< 0.06	0.14 ... 0.20	A	<b>3RK1 301-0BB00-1AA2</b>
0.06	0.18 ... 0.25	A	<b>3RK1 301-0CB00-1AA2</b>
0.09	0.22 ... 0.32	A	<b>3RK1 301-0DB00-1AA2</b>
0.10	0.28 ... 0.40	A	<b>3RK1 301-0EB00-1AA2</b>
0.12	0.35 ... 0.50	A	<b>3RK1 301-0FB00-1AA2</b>
0.18	0.45 ... 0.63	A	<b>3RK1 301-0GB00-1AA2</b>
0.21	0.55 ... 0.80	A	<b>3RK1 301-0HB00-1AA2</b>
0.25	0.70 ... 1.00	A	<b>3RK1 301-0JB00-1AA2</b>
0.37	0.90 ... 1.25	A	<b>3RK1 301-0KB00-1AA2</b>
0.55	1.1 ... 1.6	A	<b>3RK1 301-1AB00-1AA2</b>
0.75	1.4 ... 2.0	A	<b>3RK1 301-1BB00-1AA2</b>
0.90	1.8 ... 2.5	A	<b>3RK1 301-1CB00-1AA2</b>
1.1	2.2 ... 3.2	A	<b>3RK1 301-1DB00-1AA2</b>
1.5	2.8 ... 4.0	A	<b>3RK1 301-1EB00-1AA2</b>
1.9	3.5 ... 5.0	A	<b>3RK1 301-1FB00-1AA2</b>
2.2	4.5 ... 6.3	A	<b>3RK1 301-1GB00-1AA2</b>
3.0	5.5 ... 8.0	A	<b>3RK1 301-1HB00-1AA2</b>
4.0	7 ... 10	A	<b>3RK1 301-1JB00-1AA2</b>
5.5	9 ... 12	A	<b>3RK1 301-1KB00-1AA2</b>





DS1-x



RS1-x



## Selection and ordering data

Version	DT	Order No.
<b>Terminal modules for Standard motor starters</b>		
 3RK1 903-0AB00	<b>TM-DS45-S32</b> <b>for DS1-x direct-on-line starters</b> with incoming power bus connection including three caps for terminating the power bus	A 3RK1 903-0AB00
 3RK1 903-0AB10	<b>TM-DS45-S31</b> <b>for DS1-x direct-on-line starters</b> without incoming power bus connection	A 3RK1 903-0AB10
 3RK1 903-0AC00	<b>TM-RS90-S32</b> <b>for RS1-x reversing starters</b> with incoming power bus connection including three caps for terminating the power bus	A 3RK1 903-0AC00
	<b>TM-RS90-S31</b> <b>for RS1-x reversing starters</b> without incoming power bus connection	A 3RK1 903-0AC10

# SIMATIC ET 200S distributed IOs

## ET 200S Safety motor starters

### High-Feature motor starters

#### Selection and ordering data

	Setting range of the electronic release	DT	Order No.
	A		
<b>High-Feature motor starters, with diagnostics, solid-state overload protection, fuseless, expandable with brake control module</b>			
	<b>DS1e-x direct-on-line starters with switch interface</b>		
	0.3 ... 3	A	<b>3RK1 301-0AB10-0AA4</b>
	2.4 ... 8	A	<b>3RK1 301-0BB10-0AA4</b>
	2.4 ... 16	A	<b>3RK1 301-0CB10-0AA4</b>
	<b>RS1e-x reversing starters</b>		
	0.3 ... 3	A	<b>3RK1 301-0AB10-1AA4</b>
	2.4 ... 8	A	<b>3RK1 301-0BB10-1AA4</b>
	2.4 ... 16	A	<b>3RK1 301-0CB10-1AA4</b>
	<b>DSS1e-x soft starters</b>		
0.3 ... 3	A	<b>3RK1 301-0AB20-0AA4</b>	
2.4 ... 8	A	<b>3RK1 301-0BB20-0AA4</b>	
2.4 ... 16	A	<b>3RK1 301-0CB20-0AA4</b>	

DS1e-x

	Version	DT	Order No.
<b>Terminal modules for High-Feature motor starters</b>			
	<b>TM-DS65-S32 for DS1e-x and DSS1e-x direct-on-line starters</b> with incoming power bus connection including three caps for terminating the power bus	A	<b>3RK1 903-0AK00</b>
	<b>TM-DS65-S31 for DS1e-x and DSS1e-x direct-on-line starters</b> without incoming power bus connection	A	<b>3RK1 903-0AK10</b>
	<b>TM-RS130-S32 for RS1e-x reversing starters</b> with incoming power bus connection including three caps for terminating the power bus	A	<b>3RK1 903-0AL00</b>
	<b>TM-RS130-S31 for RS1e-x reversing starters</b> without incoming power bus connection	A	<b>3RK1 903-0AL10</b>

3RK1 903-0AK00

# SIMATIC ET 200S distributed IOs

## ET 200S Safety motor starters

### ET 200S Fail-safe motor starters

#### Overview

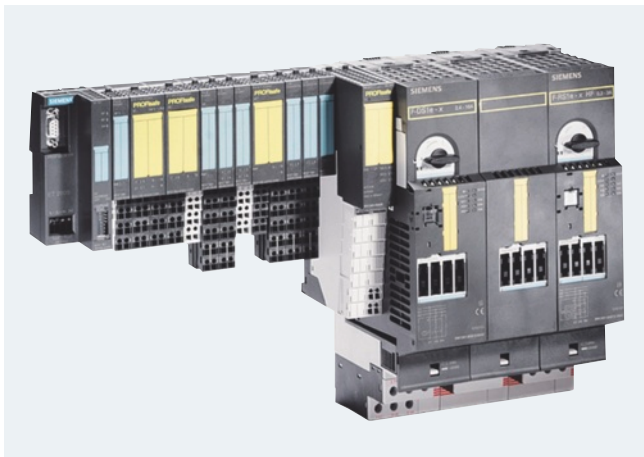

The Fail-safe motor starter has been developed on the basis of the High-Feature motor starter. It differs in that, in addition to a motor starter protector and contactor assembly, a safe solid-state evaluation circuit is installed for error detection purposes which makes the motor starter fail-safe.

If the contactor to be switched fails in an EMERGENCY-STOP case, the evaluation electronics detects a fault and opens the motor starter protector in the motor starter through a shunt release in a fail-safe manner. The second redundant shutdown component is therefore no longer a main contactor, as is generally the case, but the motor starter protector installed in the motor.

#### All functions of the High-Feature starter are already integrated

The new fail-safe motor starters are characterized by easy, space-saving assembly as well as minimal wiring outlay. Like the High-Feature starters, the fail-safe motor starters have a switching capacity of up to 7.5 kW (16 A) which is achieved with just two motor starter versions. Another important feature is the high availability due to the high short-circuit strength (type of coordination "2").

#### Benefits

- Advantages over conventional safety technology
- Significant savings in components (less hardware)
  - Less mounting and installation work
  - Motor starters are fail-safe and offer high availability

#### Application

##### Use

The fail-safe motor starter is predestined for use in combination with PROFIsafe (see figure ET 200S Safety Motor Starter Solution PROFIsafe with Fail-safe Motor Starters on page 4/16). Another field of application is in combination with ASIsafe or safety relays (see example 2 on page 4/14 Fail-safe Motor Starters with ASIsafe and 3TK28).

##### High degree of flexibility with safety technology

###### PROFIsafe solution with PM-D F PROFIsafe

In EMERGENCY-STOP applications, the fail-safe motor starters are selectively switched off through the upstream PM-D F PROFIsafe safety module. For each safety module, six switch-off groups can be formed. In the first delivery stage, the fail-safe freely-programmable logic of the SIMATIC controller is used to interface with the relevant fail-safe sensor technology. The interface between PROFIsafe and installations that use conventional safety technologies is implemented through the F-CM fail-safe contact multiplier with four floating contacts.

###### Solution local with PM-D FX1

Fail-safe motor starter with safety relay (Version 1) or ASIsafe (Version 2, see example 2, page 4/14): Signals with relevance for safety can be input to ET 200S through a PM-D F X1 infeed terminal module through the enabling circuits of the AS-i Safety Monitor or the safety relay to control the fail-safe motor starters which then selectively switch off the downstream motors.

#### Technical specifications

##### F-DS1e-x direct-on-line starter/F-RS1e-x reversing starter

		Direct-on-line starters	Reversing starters
<b>Dimensions</b>			
<b>Dimensions (W x H x D)</b>	mm	65 x 290 x 150 (incl. terminal module)	130 x 290 x 150 (incl. terminal module)
<b>Height with PE/N module</b>	mm	332	
<b>Depth with 2DI control module (not safe)</b>	mm	173	
<b>Module-specific specifications</b>			
<b>Type of coordination</b>		Type 2 up to $I_b \leq 16$ A at 400 V	
<b>Internal power supply</b>		U1 (from PM-D F/PM-DF X1)	
<b>Maximum achievable safety class</b>		SIL 3 PL e Category 4	
<b>Safety characteristics</b>			
Low demand	PFD <sub>AVG</sub> (10a)		
• Test interval 3 months		3.5 x 10 <sup>-5</sup>	
• Test interval 6 months		8.0 x 10 <sup>-5</sup>	
High demand/continuous mode	PFH		
• Test interval 3 months	1/h	8.1 x 10 <sup>-10</sup>	
• Test interval 6 months	1/h	1.8 x 10 <sup>-9</sup>	
Proof-test interval	Years	10	

# SIMATIC ET 200S distributed IOs

## ET 200S Safety motor starters

### ET 200S Fail-safe motor starters

		Direct-on-line starters	Reversing starters
<b>Voltages, currents, potentials</b>			
<b>Switching capacity</b>	A	Up to 7.5 kW at 400 V AC in three setting ranges:	
	A	0.3 ... 3	
	A	2.4 ... 8	
	A	2.4 ... 16	
<b>Status, alarms, diagnostics</b>			
<b>Status display</b>		SF, DEVICE and C-STAT, SG1 ... SG6	
<b>Diagnostics functions</b>			
Group fault display		Red LED (SF)	
Diagnostics information can be read out		Available	
<b>Control circuit</b>			
<b>Rated operational voltage for electronics <math>U_1</math></b>	V	24 DC (20.4 ... 28.8 DC)	24 DC (21.6 ... 26.4 DC)
<b>Reverse polarity protection for electronics <math>U_1</math></b>		Yes	
<b>Rated operational voltage for contactor <math>U_2</math></b>	V	24 DC (20.4 ... 28.8 DC)	
<b>Reverse polarity protection for contactor <math>U_2</math></b>		Yes	
<b>Power consumption</b>			
• From electronics supply $U_1$	mA	Approx. 40	Approx. 100
• From contactor supply $U_2$			
- Pickup	A	1.7 (for 80 ms)	--
- Hold	mA	max. 350	--
• From SG1 up to 6			
- Pickup	mA	250 (for 200 ms)	
- Hold	mA	max. 55	
• Test function of the shunt release/starter protector (50 ms) from $U_1$	A	Approx. 1.5	
• From the backplane bus	mA	Approx. 20	
<b>Main circuit</b>			
<b>Rated operational voltage <math>U_e</math></b>			
• Acc. to DIN VDE 0106, Part 1014, IEC 60947-1, EN 60947-1	V	500 AC	
• Protective separation between main and auxiliary circuits	V	400	
• UL, CSA	V	600 AC	
<b>Rated insulation voltage <math>U_i</math></b>	V	500 AC	
<b>Rated impulse withstand voltage <math>U_{imp}</math></b>	kV	6	
<b>Rated frequency</b>	Hz	50/60	

4

### Selection and ordering data

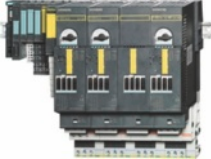
Version	DT	Order No.	
<b>ET 200S Fail-safe motor starters</b>			
 <p>F-DS1e-x direct-on-line starter</p>	<b>F-DS1e-x direct-on-line starters</b> Fail-safe direct-on-line starters up to 7.5 kW at 400 V AC Mechanically switching Solid-state UE protection		
	• 0.3 ... 3 A	A	<b>3RK1 301-0AB13-0AA4</b>
	• 2.4 ... 8 A	A	<b>3RK1 301-0BB13-0AA4</b>
	• 2.4 ... 16 A	A	<b>3RK1 301-0CB13-0AA4</b>
	<b>F-RS1e-x reversing starters</b> Fail-safe reversing starters up to 7.5 kW at 400 V AC Mechanically switching Solid-state UE protection, fuseless		
• 0.3 ... 3 A	A	<b>3RK1 301-0AB13-1AA4</b>	
• 2.4 ... 8 A	A	<b>3RK1 301-0BB13-1AA4</b>	
• 2.4 ... 16 A	A	<b>3RK1 301-0CB13-1AA4</b>	

### Selection and ordering data

Version	DT	Order No.
---------	----	-----------

#### Terminal modules for fail-safe motor starters

##### **TM-FDS65-S32-01/S31-01 terminal modules** for F-DS1e-x direct-on-line starters with coding

- |  |   |                       |
|--|---|-----------------------|
| • With incoming power bus connection<br>(TM-FDS65-S32-01)    | A | <b>3RK1 903-3AC00</b> |
| • Without incoming power bus connection<br>(TM-FDS65-S31-01) | A | <b>3RK1 903-3AC10</b> |

##### **TM-FRS130-S32-01/S31-01 terminal modules** for F-RS1e-x reversing starter with coding

- |   |   |                       |
|---|---|-----------------------|
| • With incoming power bus connection<br>(TM-FRS130-S32-01)    | A | <b>3RK1 903-3AD00</b> |
| • Without incoming power bus connection<br>(TM-FRS130-S31-01) | A | <b>3RK1 903-3AD10</b> |

# SIMATIC ET 200S distributed I/Os

## ET 200S Safety motor starters

### Safety modules local and PROFIsafe

#### Overview

#### Safety modules local

4

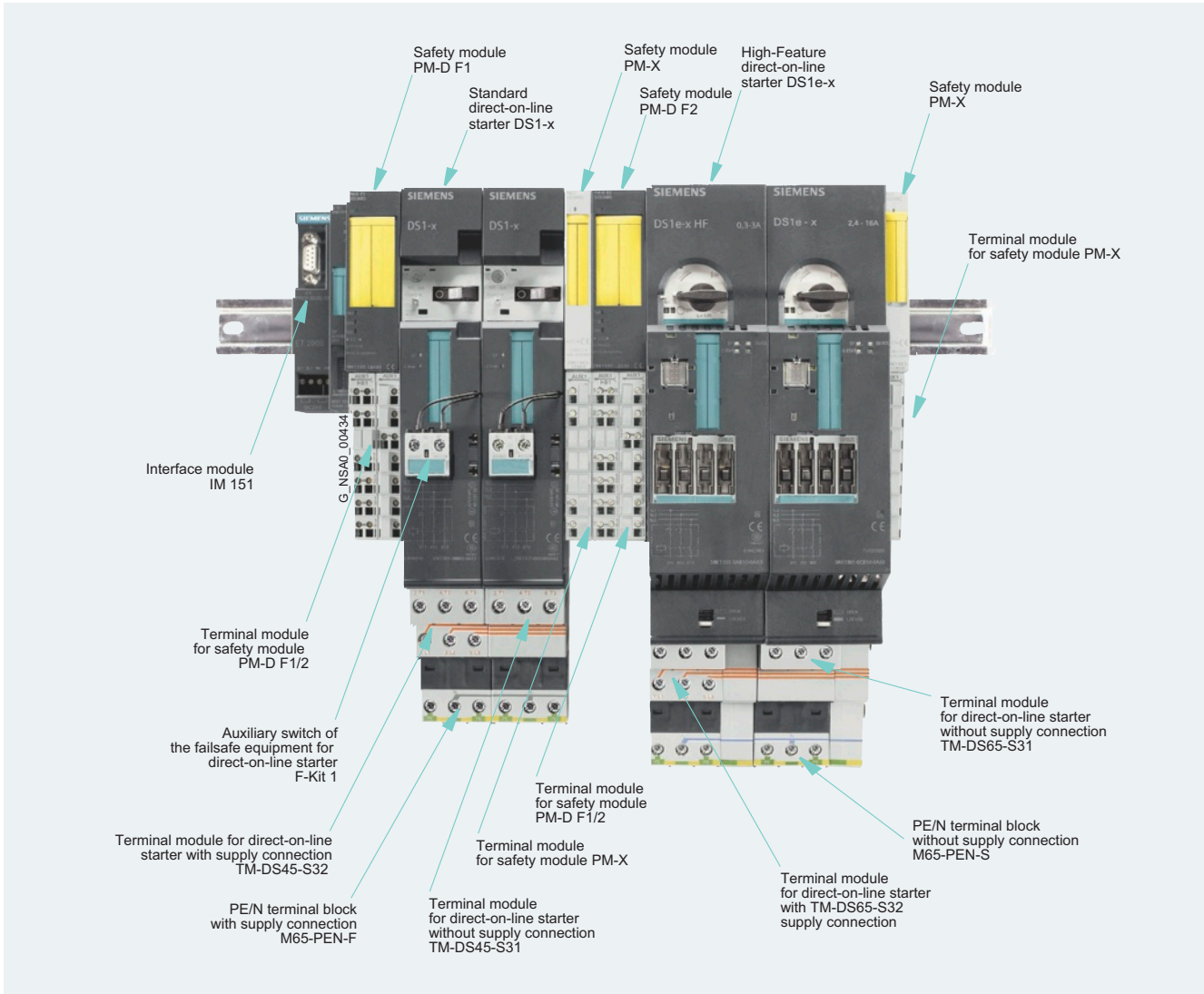

Interplay of ET 200S safety motor starters Solutions local components



PM-D F1 safety module

# SIMATIC ET 200S distributed IOs

## ET 200S Safety motor starters

### Safety modules local and PROFIsafe

#### Safety motor starters Solutions local

With the Safety motor starters Solutions local it is easy to configure several safety circuits. The safety sensors are connected directly and locally to the safety modules. These safety modules perform the work of the otherwise obligatory safety relays and safely shut down the downstream motor starters in accordance with the function selected. The crosslinks required for this are already integrated in the system and need no additional wiring. All signals from the safety modules are automatically relayed as diagnostic signals, e.g. in the event of crossover in the EMERGENCY-STOP circuit.

The highest safety category 4 according to EN 954-1 can be obtained with safety motor starters Solutions local. They can thus be used for evaluation of EMERGENCY-STOP circuits or for monitoring protective doors and also for time-delayed disconnections. With the contact multiplier the safety-relevant signals can also be made available to external systems.

All standard safety applications can be covered through combination of different TM-PF30 terminal modules. Needless to say, ET 200S motor starters can also be used in conjunction with external safety relays or with ASIsafe.

Use of the PM-DFX1 safety module: The PM-DFX1 safety module is used for feeding in 1 to 6 switch-off groups. The infeed voltage can be switched using 1 to 6 external safety shutdown devices (either ASIsafe monitors or 3TK28 safety relays). This safety module is used in applications with external safety shutdown devices where there is a need for the fully selective safety shutdown of fail-safe motor starters/frequency converters (see [example 2, page 4/14](#)).

With the Safety Motor Starter Solutions local, up to 80 % of wiring is saved compared to conventional safety systems with local safety applications.

The safety module evaluates the signal state of the connected safety sensors and, using the integrated safety relays, shuts down the group(s) of downstream motor starters. The shutdown function is monitored by the module, and the auxiliary voltages likewise.

Safety-relevant system signals, e.g. due to an actuated EMERGENCY-STOP switch or a missing auxiliary voltage, are automatically generated and notified to the interface module. The latter assigns an unambiguous ID to the fault. Using the PROFIBUS DP diagnostics module, faults of this type can be identified and localized without a great deal of programming work.

- For use of Standard, High-Feature or fail-safe motor starters in systems with safety categories 2 to 4 (according to ISO 13849-1)
- No complex wiring for conventional safety technology
- Can also be used in combination with external safety relays
- Can also be used to activate external safety systems
- Safety module available for function-monitored and automatic starting
- Safety module available for Stop category 0 and 1
- Safety module for monitoring the auxiliary voltages for motor starters
- Safety modules can be plugged into the TM-PF30 terminal modules

#### PM-D F1/F2/F3/F4/F5 safety modules

- PM-D F1/F2/F3/F4 safety modules monitor auxiliary voltages and contain the complete functionality of a safety relay:
  - PM-D F1  
For evaluation of EMERGENCY-STOP circuits with the function "monitored start".
  - PM-D F2  
For monitoring of protective doors with the function "automatic start".
  - PM-D F3  
Expansion to PM-D F1/F2 for time-delayed disconnection.
  - PM-D F4  
For expansion of safety circuits with other ET 200S motor starters, e.g. in a different line.
  - PM-D F5  
Transmits the status from PM-D F1 ... 4 through four floating enabling circuits to external safety equipment (contact multipliers)
- The PM-D F1 and PM-D F2 modules can be combined with the PM-D F3 or PM-D F4 modules.
- A PM-D F5 can be positioned at any point between a PM-D F1 ... 4 and a PM-X.
- Safety modules monitor the U1 and U2 auxiliary voltages. A voltage failure is relayed as a diagnostic signal over the bus.
  - No additional PM-D safety module is required when the safety modules are used.
  - Each safety circuit, beginning with a PM-D F1 ... 4, must be terminated with one PM-X each.

#### Terminal modules for (TM-PF30) safety module

For supplying load and sensor voltage to the potential bars of the motor starters, and for connection of the 2-channel sensor circuit (e.g. EMERGENCY-STOP pushbutton) and a reset button. Different terminal modules are available for the configuring of separate safety circuits or for the cascading of safety circuits, and for applications with time-delayed disconnection.

#### Terminal modules for (TM-X) safety module

For connection of an external infeed contactor (2nd shutdown possibility). With terminals for contactor coil and feedback contact. Is always required to terminate a group of safety-oriented motor starters.

#### Fail-safe Kit

The Fail-safe Kit (F-Kit) must be added to each Standard motor starter in a safety segment in order to monitor the switching function.

F-Kit 1 supplements the DS1-x direct-on-line starter, F-Kit 2 the RS1-x reversing starter.

The F-Kits are comprised of:

- Contact supports for the terminal modules
- One or two auxiliary switch blocks for the contactor/contactors of the motor starter
- Connecting cables

High-Feature motor starters and their terminal modules come as standard with the functionality of the F-Kits integrated.

# SIMATIC ET 200S distributed IOs

## ET 200S Safety motor starters

### Safety modules local and PROFIsafe

#### Components needed for applications with safety requirement

Components needed	Safety category acc. to EN 954-1			
	1	2	3	4
PM-D	X	--	--	--
PM-D F1/-F2/-F4	--	X	X	X
PM-D F3	--	X	X	--
F-Kit 1/2	--	X <sup>1)</sup>	X <sup>1)</sup>	X <sup>1)</sup>
PM-X	--	X	X	X
PM-DFX1	--	X	X	X
External infeed contactor	--	--	X	X

1) F-Kit needed only for Standard motor starter; already integrated in High-Feature motor starter.

#### Possible combinations of safety and terminal modules

Terminal modules	PM-D F1	PM-D F2	PM-D F3	PM-D F4	PM-D F5	PM-X	PM-DFX1	FCM
TM-PF30 S47-B0	X	X	--	--	--	--	--	--
TM-PF30 S47-B1	X	X	--	--	--	--	--	--
TM-PF30 S47-C0	--	--	X	X	--	--	--	--
TM-PF30 S47-C1	--	--	X	X	--	--	--	--
TM-PF30 S47-D0	--	--	--	--	X	--	--	--
TM-X15 S27-01	--	--	--	--	--	X	--	--
TM-PFX30 S47-G0	--	--	--	--	--	--	X	--
TM-PFX30 S47-G1	--	--	--	--	--	--	X	--
TM-FCM30 S47	--	--	--	--	--	--	--	X

#### Examples

The diverse possible uses of the safety motor starter Solutions local are presented in the manual SIMATIC ET 200S Motor Starters in the context of typical sample applications.

Safety functional examples for easy, quick and low-cost implementations of applications with Safety motor starters Solutions local are available on the Internet:

You can find more information on the Internet at:

- [www.siemens.com/sirius-starting](http://www.siemens.com/sirius-starting)
- [www.siemens.com/ET200S-motorstarter](http://www.siemens.com/ET200S-motorstarter)
- [www.siemens.com/industrymall](http://www.siemens.com/industrymall)

4

Example 1:

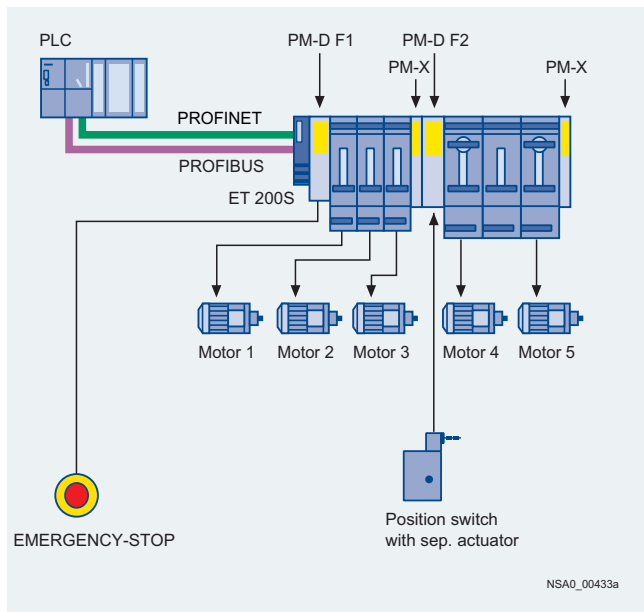

ET 200S safety motor starter Solutions local with 2 safety circuits (= switch-off groups), Standard motor starters and High-Feature motor starters.

Example 2:

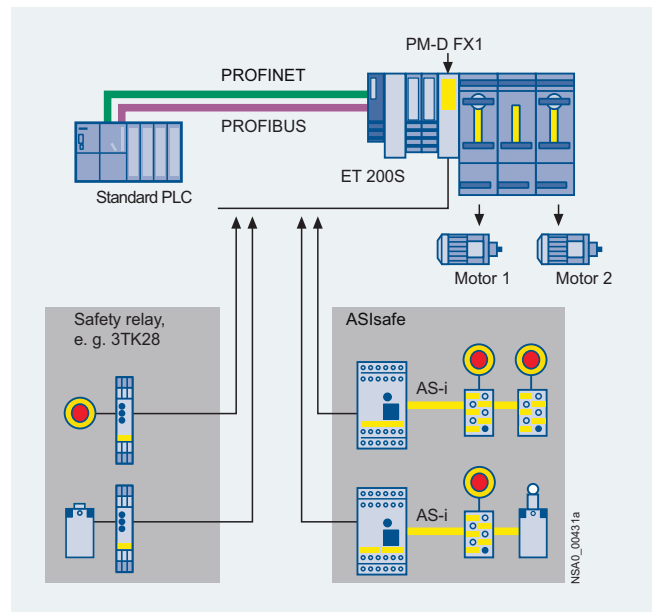

ET 200S safety motor starter Solutions local with 2 external safety assemblies (= safety relays or ASIsafe monitors) and with fail-safe motor starters (PM-DFX1 application). 2 of the 6 available safe switch-off groups are used.

Signals with relevance for safety can be input to ET 200S through a PM-DFX1 infeed terminal module through the enabling circuits of the ASIsafe monitor or the safety relay to control the fail-safe motor starters which then selectively switch off the downstream motors.



# SIMATIC ET 200S distributed IOs

## ET 200S Safety motor starters

Safety modules local and PROFIsafe

### Safety modules PROFIsafe

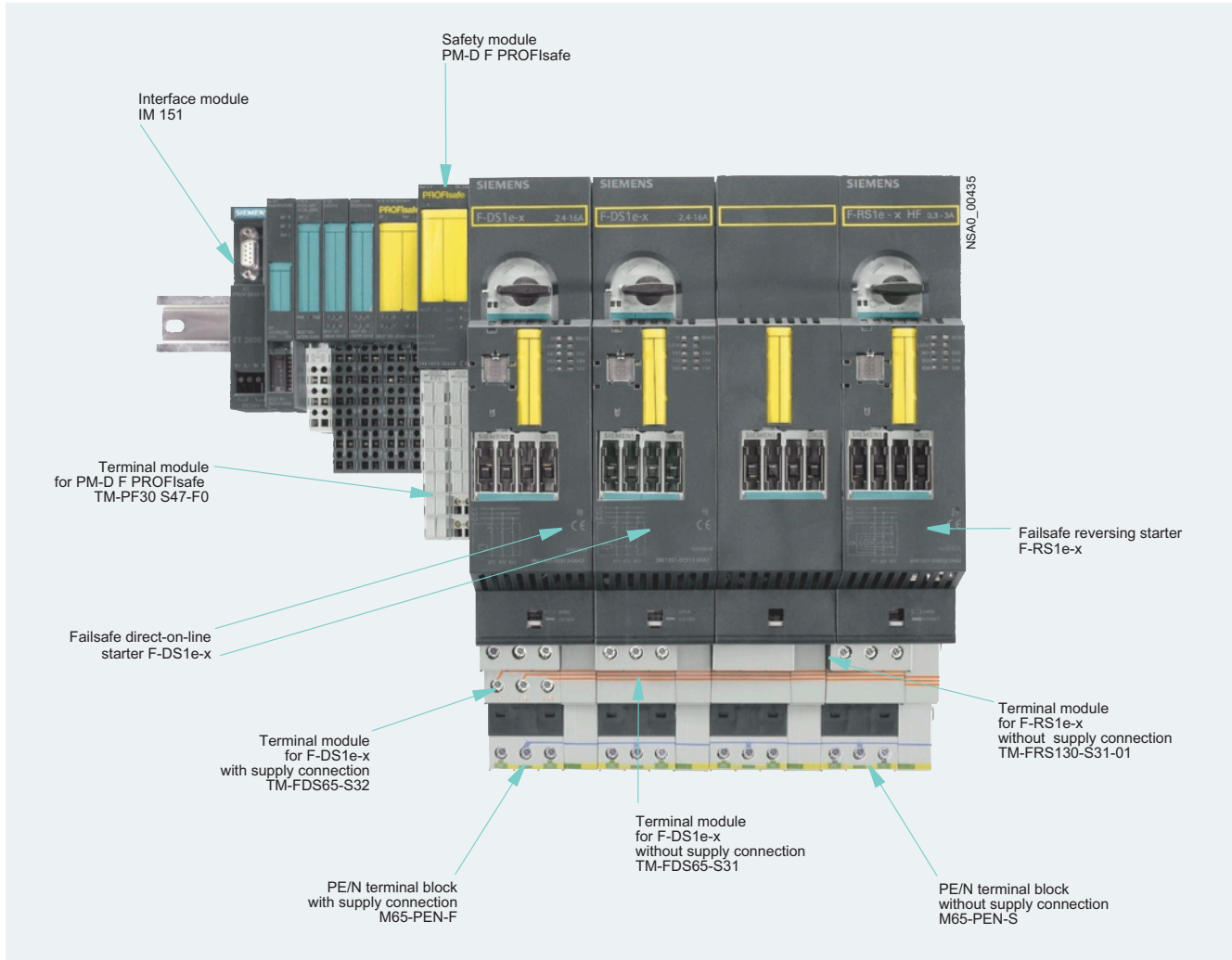

Interplay of ET 200S Safety motor starter Solutions PROFIsafe components

### Safety motor starters Solutions PROFIsafe



PM-D F PROFIsafe with TM-PF30 S47-F0 terminal module

Sensor and actuator assignment are freely configurable within the framework of the distributed safety concept:

The logic of the safety functions is implemented by software. Safety-oriented PROFIsafe communication and the use of a safety-oriented control system are required.

Integration of the safety technology in the standard automation is realized through a single bus system (see Advantages of PROFIsafe), using PROFIBUS as well as PROFINET.

- For the use of fail-safe motor starters in plants with safety category 2 to 4 according to EN 954-1 and SIL 2 and 3 acc. to IEC 61508. The use of Standard or High-Feature motor starters is also possible with certain assemblies
- High flexibility (any assignment of sensors to motor starters using the PLC)
- Full selectivity of disconnection of the fail-safe motor starters
- No complex wiring for conventional safety systems, e.g. no in-feed contactors even in the highest safety category
- Can also be used to activate external safety systems through F-CM contact multiplier
- Safety module available for any safety function
- Safety module available for Stop category 0 and 1
- Safety module for monitoring the auxiliary voltages for motor starters
- Safety modules can be plugged into the TM-PF30 terminal modules

# SIMATIC ET 200S distributed IOs

## ET 200S Safety motor starters

### Safety modules local and PROFIsafe

#### High degree of flexibility with safety technology Fail-safe motor starters for PROFIsafe:

In EMERGENCY-STOP applications, the fail-safe motor starters are selectively switched off through the upstream PM-D F PROFIsafe safety module. For each safety module, six switch-off groups can be formed. In the first delivery stage, the fail-safe freely-programmable logic of the SIMATIC controller is used to interface with the relevant fail-safe sensor technology. The interface between PROFIsafe and installations that use conventional safety technologies is implemented through the F-CM fail-safe contact multiplexer with four floating contacts.

#### Example:

The diverse possible uses of the Safety motor starter Solutions PROFIsafe are presented in the manual SIMATIC ET 200S Motor Starters in the context of typical sample applications.

Safety functional examples for easy, quick and low-cost implementations of applications with safety motor starters Solution PROFIsafe are available on the Internet:

You can find more information on the Internet at:

[www.siemens.com/sirius-starting](http://www.siemens.com/sirius-starting)

[www.siemens.com/ET200S](http://www.siemens.com/ET200S)

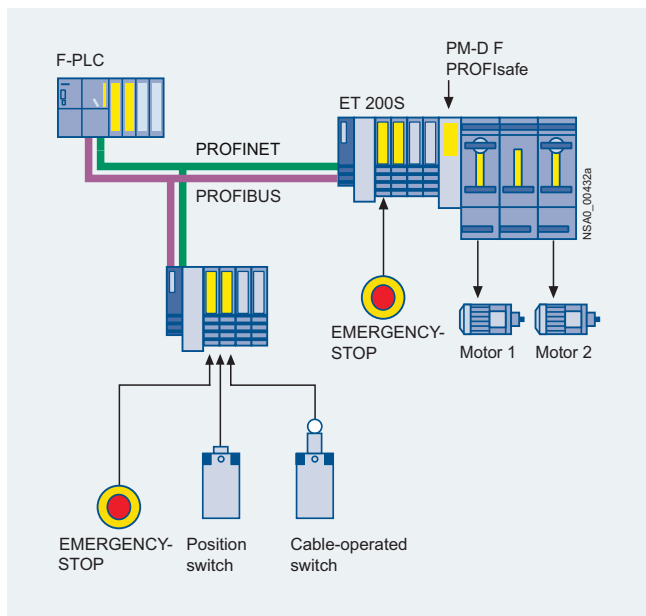

ET 200S Safety motor starters Solutions PROFIsafe with fail-safe motor starters and fully selective disconnection (PM-DF PROFIsafe application)

Within an ET 200S station the fail-safe motor starters are assigned to one of 6 safety segments. For plants with distributed configuration the shutdown signals of these safety segments are preferably issued by a higher-level, safety-oriented control system through PROFIsafe. This permits the greatest flexibility for assigning the motor starters to different safety circuits.

Alternatively, an ET 200S F-CPU can also be used for control purposes.

If a safety-oriented SIMATIC CPU is used, the ET 200S is available as a safety-oriented peripheral. Nevertheless, in such a station it is possible to configure conventional motor starters and input/output modules mixed with modules with safety functions.

Thanks to the PROFIsafe profile, the safety functions are available in the complete network, which means that the Safety motor starter Solutions PROFIsafe enable the selective disconnection of a fail-safe motor starters or the disconnection of a group of Standard and High-Feature motor starters regardless of where and on which peripheral station the safe control devices were connected. As such, this solution provides an unprecedented level of flexibility and reduction of wiring for applications in

wide-spread plants or with a sporadic demand for changes in the assignment of safety segments.

The Solution PROFIsafe safety motor starters are ideally suited for safety concepts with Cat. 2 to 4 according to EN 954-1- or up to SIL 3 according to IEC 61508.

Each safety module switches up to 6 switch-off groups for fail-safe motor starters/frequency converters.

#### PM-D F PROFIsafe safety modules

The PM-D F PROFIsafe safety module receives the shutdown signal from the interface module of the ET 200S and safely switches off 1 to 6 switch-off groups. This safety module is used in PROFIsafe applications where there is a need for the selective safety shutdown of fail-safe motor starters/frequency converters.

The terminal assignment of the terminal modules for safe motor starters corresponds to the terminal assignment of the 45 and 65 mm terminal modules. The terminal modules for safe motor starters have a coding module in addition. This enables the safe motor starter to be assigned to one of the six switch-off groups.

The terminal module contains three coding elements which fully cover the three coding openings in the terminal module. The labeled coding element contains (in the chamber marked with the dash) the busbar tap; the non-labeled coding elements are used only to cover the coding openings. Switch-off group 1 (AG1 or SG1) is coded in the as-delivered state. The coding can be changed to switch-off group 2 by releasing the coding element and turning it through 180°. Changing the coding to switch-off group 3 is possible by exchanging the labeled and blank coding elements. In this case the dash on the labeled coding element must correlate with the dash of the required switch-off group (symbolized busbar).

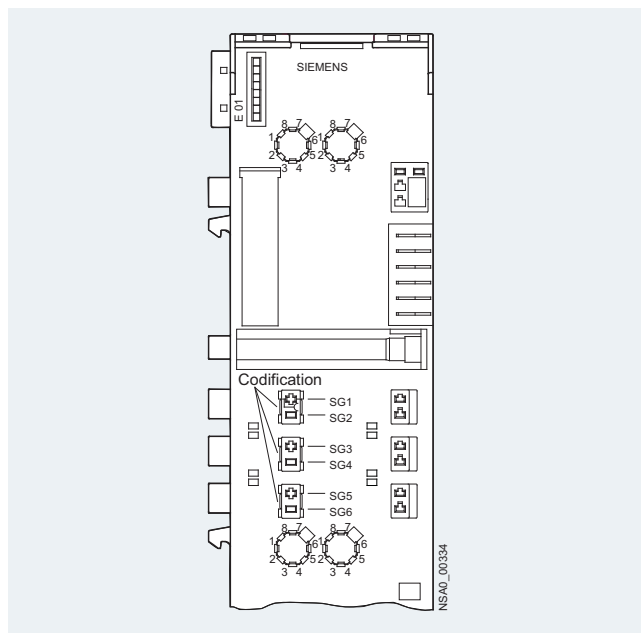

The fail-safe motor starters are assigned to one of the six possible switch-off groups.

# SIMATIC ET 200S distributed IOs

## ET 200S Safety motor starters

Safety modules local and PROFIsafe

### Selection and ordering data

	Version	DT	Order No.
<b>Safety modules local</b>			
 <p>3RK1 903-3DA00</p>	<b>PM-D F1</b> With diagnostics Safety module for EMERGENCY-STOP application Monitored start	A	<b>3RK1 903-1BA00</b>
	<b>PM-D F2</b> With diagnostics Safety module for protective door monitoring Automatic start	A	<b>3RK1 903-1BB00</b>
	<b>PM-D F3</b> With diagnostics Safety module for expanding PM-D F1/2 for another voltage group Time-delayed 0 to 15 s	A	<b>3RK1 903-1BD00</b>
	<b>PM-D F4</b> With diagnostics Safety module for expanding PM-D F1/2 for another voltage group	A	<b>3RK1 903-1BC00</b>
	<b>PM-D F5</b> With diagnostics Safety module for expanding PM-D F1...4 with four floating enabling circuits Contact multipliers	A	<b>3RK1 903-1BE00</b>
	<b>PM-D FX1</b> With diagnostics Infeed terminal module for supply of 1 to 6 switch-off groups	A	<b>3RK1 903-3DA00</b>
	<b>FC-M contact multipliers</b> With 4 safe floating contacts	A	<b>3RK1 903-3CA00</b>
<b>Safety modules PROFIsafe</b>			
	<b>PM-D F PROFIsafe safety modules</b> For PROFIBUS and PROFINET For fail-safe motor starters For fail-safe contact multipliers With six switch-off groups (SG1 to SG6)	A	<b>3RK1 903-3BA01</b>
	<b>F-CM contact multipliers</b> With 4 safe floating contacts	A	<b>3RK1 903-3CA00</b>

# SIMATIC ET 200S distributed IOs

## ET 200S Safety motor starters

### Safety modules local and PROFI-safe terminal modules

#### Overview

##### Terminal modules for safety modules

For supplying load and sensor voltage to the self-assembling potential bars of the Standard motor starters, High-Feature motor starters and frequency converters. Safety modules for voltage monitoring are plugged onto TM-P modules. TM-P modules can be used any number of times within the ET 200S. A safety module must always be plugged upstream from the first motor starter.

Different safety circuits can be functionally separated or else cascaded using different terminal modules. Each group in such a case must be terminated with a PM-X connection module.

##### TM-PF30 S47-B1

The terminal module is always positioned at the beginning of a safety segment and accommodates the PM-DF1 safety module for EMERGENCY-STOP applications or the PM-DF2 safety module for protective door monitorings. The 24 V supply voltages for the electronics (U1) and those for supplying the contactors (U2) of the motor starters must be connected along with the 2-channel connection of the safety sensors (e.g. EMERGENCY-STOP pushbuttons) to this terminal module. Connections for the ON button (enabling) and safe output of the safety module are available in addition.

##### TM-PF30 S47-B0

The terminal module is used to cascade lower level safety segments and accommodates the PM-DF1 safety module for EMERGENCY-STOP applications or the PM-DF2 safety module for protective door monitorings. No other auxiliary voltage has to be connected to this terminal module. The supply comes from the preceding PM-DF1 or PM-DF2 module over the potential bars of the terminal modules. Once the potential of the preceding safety module is disconnected, this sub-potential also has no voltage.

##### TM-PF30 S47-C1

The terminal module is always positioned at the beginning of a safety segment expansion in a new station, e.g. at an interlace point. It accommodates the PM-D F3 safety module for time-de-

layed shutdown or the PM-D F4 safety module for direct shutdown in separately located ET 200S stations. The 24 V supply voltages for the electronics (U1) and those for supplying the contactors (U2) are fed in new.

The shutdown command from an upstream ET 200S station is received through a safe input. Separate terminals are available to connect the feedback circuit to the upstream ET 200S station. No safety sensors can be connected to this terminal module.

##### TM-PF30 S47-C0

The terminal module is used to cascade lower level safety segments and accommodates the PM-D F3 safety module for time-delayed shutdown or the PM-D F4 safety module. Only the U2 supply voltage for the contactors must be connected to this terminal module. The U1 supply comes from the preceding safety module (sub-potential group) over the potential bars of the terminal modules. No safety sensors can be connected to this terminal module.

##### TM-PF30 S47-D0

The terminal module is used to accommodate the PM-D F5 safety module. On this terminal module, safe signals can be relayed to external systems through four groups, each with two safety relay contacts configured with redundancy. The terminal module must always be positioned between one of the above mentioned terminal modules and a terminal module for the TM-X connection module. No safety sensors can be connected to this terminal module.

##### Terminal modules for connection modules (TM-X)

For connection of an external infeed contactor (second shutdown option) for category 3 and 4. The connection module is plugged on the right alongside the last motor starter of a safety segment. On the TM-X terminal module there are the terminals for connecting the positively driven NC contact of the contactors as well as the terminals for connecting the contactor coil. If no contactor with redundant switching is required, e.g. for category 2 (EN 954-1), the feedback circuit has to be closed at these terminals with a jumper. In applications with external safety relays it is also used instead of the safety module as interface to the ex-

4

#### Technical specifications

##### TM-PFX30 S47/TM-PF30 S47 terminal modules

Dimensions		
Mounting dimensions (W x H x D)	mm	30 x 196.5 x 102
Depth with power module	mm	117.5
Insulation voltages and rated currents		
Insulation voltage	V	500
Rated operational voltage	V	24 DC
Rated operational current	A	10
Conductor cross-sections		
Solid	mm <sup>2</sup>	1 x (0.14 ... 2.5), according to IEC 60947 1 x 2.5
Finely stranded with end sleeve	mm <sup>2</sup>	1 x (0.14 ... 1.5), according to IEC 60947
AWG cables, solid or stranded	AWG	1 x (18 ... 22)
Wiring		
Required tool		Standard screwdriver size 1
Tightening torque	Nm	0.4 ... 0.7

**Selection and ordering data**

Version	DT	Order No.
---------	----	-----------

**Terminal modules for Safety modules local**

3RK1 903-1AA00

**Terminal modules**
**TM-PF30 S47-B1**

For PM-D F1/2 Safety Modules  
With infeed U1/U2 and sensor connection

A **3RK1 903-1AA00**
**TM-PF30 S47-B0**

For PM-D F1/2 Safety Modules  
With sensor connection

A **3RK1 903-1AA10**
**TM-PF30 S47-C1**

For PM-D F3/4 Safety Modules  
With infeed U1/U2  
and control input IN+/IN-

A **3RK1 903-1AC00**
**TM-PF30 S47-C0**

For PM-D F3/4 Safety Modules  
With infeed U2

A **3RK1 903-1AC10**
**TM-PF30 S47-D0**

For PM-D F5 Safety Modules

A **3RK1 903-1AD10**
**TM-X15 S27-01**

For PM-X Safety Module

A **3RK1 903-1AB00**
**TM-P15-S27-01 terminal modules**

For PM-D power module

A **3RK1 903-0AA00**
**TM-PFX30 S47-G0/G1 terminal modules**

For PM-D FX1 safety modules (infeed terminal modules)

• Infeed left (TM-PFX30 S47-G0)

A **3RK1 903-3AE10**

• Infeed center (TM-PFX30 S47-G1)

A **3RK1 903-3AE00**
**TM-FCM30 S47-F01 terminal modules**

For F-CM contact multipliers

A **3RK1 903-3AB10**
**Terminal modules for Safety modules PROFIsafe**
**TM-PF30 S47-F0 terminal modules**

For PM-D F PROFIsafe safety modules

A **3RK1 903-3AA00**
**TM-FCM30 S47-F01 terminal modules**

For F-CM contact multipliers

A **3RK1 903-3AB10**

# SIMATIC ET 200S distributed IOs

## ET 200S Safety motor starters

### Accessories for Standard and High-feature motor starters

#### Overview

##### **Accessories for Standard motor starters**

###### Control kits

The control kit for the Standard motor starter provides the possibility of testing the motor during start-up or service by actuating the motor starter protector. Using the control kit with the motor starter protector tripped, the contactor is mechanically locked in ON position.

###### Control unit

With the control unit the contactor coils of the Standard motor starter can be directly controlled using 24 V DC. The motor starter can thus be started as normal using a on-site control point without PLC or bus.

###### Note:

*The control unit cannot be used in combination with the safety system or a brake control module.*

###### DM-V15 distance module

- Passive module without bus connection and terminals
- Does not need a separate terminal module
- Follows a TM-DS45 or TM-RS90 or TM-xB if required
- Does not need to be taken into account when configuring the GSD file

The distance module is available for applications with high motor currents or high ambient temperatures involving Standard motor starters. It can be used to the right and left of a DS1-x direct-on-line starter or to the right of an xB1-4 brake module in order to improve heat removal to the side. The distance module is a completely passive module and does not need to be taken into account with regard to the control system during configuration. Details of the distance module can be found in the manual "SIMATIC ET 200S". If you have any queries concerning the use of the distance module, contact Technical Support for Siemens Low-Voltage Controls and Distribution (fax: +49(0)911/895-5907).

##### **Accessories for High-Feature motor starters**

###### 2DI 24 V DC COM control module

The 2DI 24 V DC COM control module is plugged onto the interface on the front of the motor starter. The module provides two inputs which can receive signals from the process and be assigned directly to the starter.

The functionality can be selected from a list of various control functions as part of the PROFIBUS parameterization. On-site control point, emergency start and quick stop, for example, are available as functions. The signal levels can also be parameterized (NO/NC). For more extensive control functions the two inputs of a xB3 or x4 brake control module, which is plugged in alongside on the right, can be integrated in addition. The signal states of all inputs are transmitted in parallel with the internal use to the higher-level control system.

When a motor starter is replaced, the parameterization is automatically transmitted by download to the new starter. The inputs on the motor starter ensure autonomous operation, e.g. in the event of PLC failure, on the one hand and short response times through direct processing in the starter on the other hand. Another advantage results from the direct assignment of functions to modular machine concepts.

The 2DI 24 V DC COM control module has in addition a PC interface for connecting the Switch ES Motor Starter parameterization and diagnostics software (Version 2.0 and higher). The module works solely on High-Feature motor starters with ES Motor Starter interface. The Logo!-PC cable is used as connecting

cable between the 2DI 24 V DC COM control module and the High-Feature motor starter.

##### **Accessories for Standard and High-Feature motor starters**

###### PE/N bridge module

PE/N bridge modules are used to bridge gaps in the PE/N bus which are caused, for example, by using brake control modules, PM-D(F) power modules or PM-X connection modules. If a bridge module is used, the supply must not be fed in anew. They are available in widths of 15 and 30 mm.

###### L123 bridge modules

The L123 bridge modules are used to bridge gaps in the power bus (see above). They are available in widths of 15 and 30 mm.

###### Brake control module

for motors with mechanical brake

###### Terminal modules for brake control modules

The TM-xB terminal modules are used to accommodate the xB1, xB2, xB3 and xB4 brake control modules. The TM-xB terminal module must always follow directly after a terminal module for Standard motor starters, High-Feature motor starters or frequency converters as control of the solid-state braking switch is provided through an output of the motor starter/frequency converter. The xB215 terminal modules for the brake control modules have not only the terminals for connecting the cable for the motor brake but also the terminals of the two local acting inputs. These local inputs are not evaluated by a frequency converter, which is why the xB215 terminal module can only be switched behind a motor starter.

##### **Accessories for Standard, High Feature, fail-safe motor starters**

###### PE/N terminal blocks

The PE/N terminal block is required for direct connection of the protective conductor in the motor cable without intermediate terminals. It is plugged together with the terminal module for motor starters or frequency converters before the latter is mounted on the standard mounting rail. With two PE terminals and one N terminal the "-F" version is connected to the "-S32" terminal modules for motor starters or frequency converters. The "-S" version is combined with the "-S31" terminal module. The "F" terminal modules are delivered with two caps for closing the PE/N bus contacts on the final terminal module of a segment. The modules for the Standard motor starters have a width of 45 mm and the modules for the High-Feature motor starters and frequency converters have a width of 65 mm.

There is no electrical connection between the terminals of the PE/N terminal block and the integrated shielding of the frequency converter. The PE/N terminal block must therefore not be used for the shielding of the motor cable.

# SIMATIC ET 200S distributed IOs

## ET 200S Safety motor starters

Accessories for Standard and High-feature motor starters

### Selection and ordering data

Version	DT	Order No.
<b>Accessories for Standard motor starters</b>		
 3RK1 903-0CA00	<b>Control kits</b> for manually operating the contactor contacts during start-up and servicing (one set contains five control kits)	A 3RK1 903-0CA00
 3RK1 903-0CG00	<b>Control units</b> for direct contactor control (manual control) 24 V DC	A 3RK1 903-0CG00
 3RK1 903-0CD00	<b>DM-V15 distance modules for DS1-x direct-on-line starters with high temperatures or high current loading</b> 15 mm wide	A 3RK1 903-0CD00
 3RK1 903-2AA00	<b>PE/N M45-PEN-F terminal blocks</b> 45 mm wide including two caps in combination with TM-DS45-S32 / TM-RS90-S32	A 3RK1 903-2AA00
 3RK1 903-2AA10	<b>PE/N M45-PEN-S terminal blocks</b> 45 mm wide in combination with TM-DS45-S31 / TM-RS90-S31	A 3RK1 903-2AA10
<b>Accessories for High-Feature motor starters</b>		
 3RK1 903-0CH20	<b>2DI 24 V DC COM control modules</b> Digital input module with 2 inputs (cable length up to 100 m) for local motor starter functions for mounting onto the front of motor starters, operational voltage 24 V DC (supplied from $U_1$ ), short-circuit proof, floating contact with serial interface for connecting ES motor starters, connected using LOGO!-PC cable	A 3RK1 903-0CH20
 3RK1 922-3BA00	<b>LOGO! PC cables</b> for connecting the High-Feature motor starter with ES interface switch to a PC	A 6ED1 057-1AA00-0BA0
 3RK1 922-3BA00	<b>Hand-held devices</b> for ET 200S High-Feature motor starters, (also for ET 200pro and ECOFAST), for on-site operation. A serial interface cable must be ordered separately.	B 3RK1 922-3BA00
	<b>M65-PEN-F terminal blocks</b> 65 mm wide, including two caps, in combination with TM-DS65-S32 / TM-RS130-S32	A 3RK1 903-2AC00

# SIMATIC ET 200S distributed IOs

## ET 200S Safety motor starters

### Accessories for Standard and High-feature motor starters



Version	DT	Order No.
<b>M65-PEN-S terminal blocks</b> 65 mm wide, in combination with TM-DS65-S31 / TM-RS130-S31	A	<b>3RK1 903-2AC10</b>
<b>Accessories for Standard / High-Feature motor starters</b>		
 3RK1 903-0AH00	<b>M15-PE/N bridge modules</b> 15 mm wide for bridging a 15 mm module	A <b>3RK1 903-0AH00</b>
 3RK1 903-0AJ00	<b>M30-PE/N bridge modules</b> 30 mm wide for bridging a 30 mm module	A <b>3RK1 903-0AJ00</b>
 3RK1 903-0AE00	<b>M15-L123 bridge modules</b> 15 mm wide for bridging a 15 mm module	A <b>3RK1 903-0AE00</b>
 3RK1 903-0AF00	<b>M30-L123 bridge modules</b> 30 mm wide for bridging a 30 mm module	A <b>3RK1 903-0AF00</b>
 3RK1 903-0AF20	<b>Sealing caps</b> for L123 bridge modules and PE/N	A <b>3RK1 903-0AF20</b>
 3RK1 903-0CB00	<b>Brake control modules</b> for motors with mechanical brakes	
	<ul style="list-style-type: none"> <li>• <b>xB1 for motor starters</b> 24 V DC/4 A</li> <li>• <b>xB2 for motor starters</b> 500 V DC/0.7 A</li> <li>• <b>xB3 for motor starters</b> 24 V DC / 4 A / 2 DI 24 V DC local control with diagnostics, with two inputs</li> <li>• <b>xB4 for motor starters</b> 500 V DC / 0.7 A / 2 DI 24 V DC local control with diagnostics, with two inputs</li> </ul>	A <b>3RK1 903-0CB00</b> A <b>3RK1 903-0CC00</b> A <b>3RK1 903-0CE00</b> A <b>3RK1 903-0CF00</b>
	<b>Terminal modules for brake control modules</b>	
	<ul style="list-style-type: none"> <li>• <b>TM-xB15 S24-01</b> for xB1 or xB2</li> <li>• <b>TM-xB215 S24-01</b> for xB3 or xB4</li> </ul>	A <b>3RK1 903-0AG00</b> A <b>3RK1 903-0AG01</b>
<b>Accessories for fail-safe motor starters</b>		
	<b>PE/N M65-PEN-F terminal blocks</b> With incoming connection, with caps	A <b>3RK1 903-2AC00</b>
	<b>M65-PEN-S terminal blocks</b> without incoming connection	A <b>3RK1 903-2AC10</b>



# SIMATIC ET 200S distributed IOs

## ET 200S Safety motor starters

Accessories for Standard and High-feature motor starters

Version	DT	Order No.
<b>Accessories for power modules</b>		
<b>Color coding plates</b>		
6 x 200 color coding plates for terminal modules One set contains 10 strips of 20 color coding plates per color		
• White	X	<b>6ES7 193-4LA10-0AA0</b>
• Yellow	X	<b>6ES7 193-4LB10-0AA0</b>
• Yellow and green	X	<b>6ES7 193-4LC10-0AA0</b>
• Red	X	<b>6ES7 193-4LD10-0AA0</b>
• Blue	X	<b>6ES7 193-4LF10-0AA0</b>
• Brown	X	<b>6ES7 193-4LG10-0AA0</b>
<b>Accessories for Safety modules local</b>		
<b>PM-X safety modules</b>		
With diagnostics Module for connecting a safety group and for connecting an external infeed contactor or for connecting to an external safety circuit		
	A	<b>3RK1 903-1CB00</b>
<b>F-Kit 1</b>		
Fail-safe equipment for DS1-x <sup>1)</sup> Standard motor starters		
	A	<b>3RK1 903-1CA00</b>
<b>F-Kit 2</b>		
Fail-safe equipment for RS1-x <sup>1)</sup> Standard motor starters		
	A	<b>3RK1 903-1CA01</b>

3RK1 903-1CA00

3RK1 903-1CA01

<sup>1)</sup> The function of the fail-safe-kit is already integrated into High-Feature motor starters.

# SIMATIC ET 200S distributed IOs

## ET 200S Safety frequency converters

### ET 200S FC fail-safe frequency converter

#### Overview



Components of the ET 200S FC fail-safe frequency converter

- Parameters are assigned using STARTER, the graphical parameterizing tool for Siemens drives, either via the connected fieldbus or via a point-to-point connection.  
Note: Access to the frequency converter via the bus is not possible using STARTER if there is a CPU between the PC and the frequency converter. This also applies to CPU IM 151-7.
- Active braking is possible without additional overhead. The line-commutated energy recovery of the frequency converter for the power supply network means that brake chopper modules or pulsed resistors are superfluous.
- The "safe standstill" is completely electronic and therefore without contacts. This provides reliable and extremely short response times.
- A unique feature is that the "Safely Limited Speed" and the "Safe Stop 1" do not require a motor encoder or other encoder. These functions can therefore be implemented with minimum overhead.

#### Benefits

- Frequency converters with integrated safety functions "Safe Torque OFF", "Safely Limited Speed" and "Safe Stop 1".
- The frequency converter is completely integrated into the ET 200S system and offers all system advantages, such as high availability thanks to the hot swapping function, modular expansion, or reduction of the wiring overhead resulting from the self-assembling terminal module wiring.
- With self-assembling 50 A power bus, i.e. the load voltage is only supplied once for a group of frequency converters
- Comprehensive diagnostics facilities for high availability
- Input for motor encoder for precise speed control
- Input for PTC/KTY encoder for comprehensive motor protection
- Slot for optional memory card (MMC) to save the parameter settings for fast replacement of modules without tools
- All common control modes are available: Frequency control, sensor-less vector control or torque control, closed-loop control with motor encoder

#### Application

- New application possibilities are opened up for the ET 200S system where continuous control of the speed of asynchronous motors is required.
- The frequency converter handles frequency control and vector control for more complex drive tasks. In addition, the converter also supports torque control for conveyor applications, winding and unwinding drives, as well as hoisting gear. Together with a motor encoder, the range extends up to closed-loop controls for exact control of speeds and torques.
- The advantages of line-commutated power regeneration are primarily evident in continuous regenerative operation. Examples include unwinding units, lowering of loads with hoisting gear, or electric braking of large centrifugal masses.
- Together with an intelligent header module (IM 151 CPU) and the ET 200S FC frequency converter, the I/O station is expanded to become a complete automation solution for machine modules and plant sections.
- The integral safety functions significantly reduce the overhead for drive solutions in plant sections where there is a hazard potential. Monitoring of the safely reduced speed in sensor-less standard asynchronous motors is unique in drive engineering.

#### Certification

Product group	Product type	Order No.	Category	SIL CL	PL	PFH <sub>D</sub>	Proof Test Interval (years)	Notes
SIMATIC ET 200S	ET 200S FC (FW1.x)	6SL3244-0SA01-1AA0 3	3	2	PL d	$5 \cdot 10^{-8}$	20	Values include Control Unit and Power Module
	ET 200S FC (FW3.x)	6SL3244-0SA01-1AA1 3	3	2	PL d	$5 \cdot 10^{-8}$	20	

# SIMATIC ET 200S distributed IOs

## ET 200S Safety frequency converters

### ET 200S FC fail-safe frequency converter

#### Design

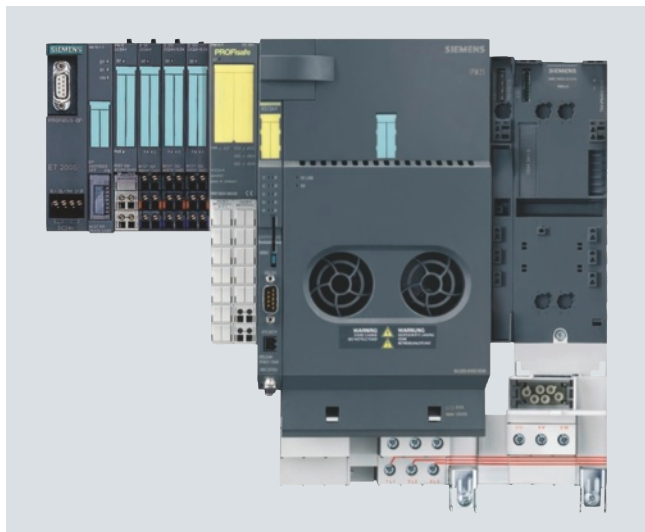

Design of an ET 200S station with two ET 200S FC fail-safe frequency converters (on the right only terminal modules)

The ET 200S FC consists of the following components:

- ICU24F control unit (F = with integral safety technology)
- IPM25 converter power module
- Terminal modules to accommodate control unit and converter power module

Following insertion of the modules, the control unit and the converter power module of the frequency converter are interconnected.

The PM-D F PROFIsafe or PM-D F X1 power modules provide the power supply for one or more control units.

#### Accessories

The following accessories are available:

- The labeling strips and color coding labels of the ET 200S system can also be used for the frequency converter.
- **Jumper block L1/L2/L3**  
The jumper blocks L1/L2/L3 are used to bridge a gap in the power bus. 15 mm wide jumper blocks are used to bridge the control unit of the subsequent frequency converter. If a Brake Control Module is connected, a 30 mm wide jumper block is required in order to pass on the power bus via the Brake Control Module and ICU24 to the subsequent IPM25 converter power module.
- **Jumper block PE/N**  
The jumper blocks PE/N are used to bridge a gap in the PE/N bus, e.g. caused by use of a Brake Control Module, a PM-D(F) power module or the control unit of the frequency converter.
- **EMC filter**  
An EMC filter must be externally connected to the supply of the power bus in order to achieve EMC Class A (according to EN 55011). Shielded motor cables must be used in addition. It must be ensured that the shield is connected correctly. The terminal modules for the converter power module of the frequency converter are equipped with an integral shield connection element.  
Within the ET 200S system, several frequency converters can be supplied over a common power bus with 400 V. The EMC filter is connected up-circuit of the power bus. The filters are designed for a maximum effective length of 350 m shielded cable. The effective cable length is the combined length of all motor cables of the frequency converter on the common 400 V power bus.  
The two EMC filters of the ET 200S FC are designed as group filters for more than one frequency converter and have the following properties:

EMC filter Type	Rated current	Maximum cable length	Conductor cross-section
6SL3203-0BE22-5AA0	25 A	350 m	4 mm <sup>2</sup>
6SL3203-0BE25-0AA0	50 A	350 m	10 mm <sup>2</sup>

The use of output reactors or LC filters on the converter output does not affect the maximum cable length for the EMC filter.

- **Output reactors and LC filters for longer cable lengths**  
Without additional components on the converter output, the maximum length of motor cables on the SIMATIC ET 200S FC frequency converter is 50 m (shielded cable) or 100 m (unshielded). Longer cables are possible when output reactors or LC filters are used:  
To reduce the capacitive equalizing currents and  $dv/dt$  for motor cables, output reactors are provided. Consequently when output reactors are used, the maximum permissible cable lengths between the motor and converter are:

IPM25 converter power module	Output reactor Type	Max. permissible motor cable lengths (shielded/unshielded) for a line voltage of	
		380 V -10 % to 400 V	401 V to 480 V +10 %
0.75 kW	6SE6400-3TC00-4AD2	150 m/225 m	100 m/150 m
2.2 kW and 4.0 kW	6SE6400-3TC01-0BD3	150 m/225 m	100 m/150 m

# SIMATIC ET 200S distributed IOs

## ET 200S Safety frequency converters

### ET 200S FC fail-safe frequency converter

#### Design (continued)

The LC filter limits the rate of rise of voltage and the capacitive charge/discharge currents which occur with converter operation. This means that considerably longer motor cables can be used for operation with LC filters. The service life of the motor is as long as for direct mains operation. It is therefore not necessary to use an output reactor. When LC filters are used, the maximum permissible cable lengths between the motor and converter are:

IPM25 converter power module	LC filter Type	Max. permissible motor cable lengths (shielded/unshielded) for a line voltage of 380 V to 480 V -10 % +10 %
0.75 kW	6SE6400-3TD00-4AD0	200 m/300 m
2.2 kW and 4.0 kW	6SE6400-3TD01-0BD0	200 m/300 m

When an output reactor or LC filter is used, it is important to note the following during assembly and start-up:

The output reactors and LC filters must be mounted alongside or below the ET 200S station. Vertical alignment is important to ensure adequate cooling. The connecting cable to the converter must be pre-assembled for all components and shortened to a length of approximately 30 cm - the shield of the motor cable must be attached to the output reactor or the LC filter.

The pulse frequency of the converter must be reduced to 4 kHz (the factory setting is 8 kHz). In addition, when an LC filter is used, the converter must be operated in *V/f* mode.

- **Shield clamps**  
To connect the shield of motor cables
- **Grounding terminal**  
To ground the 3 x 10 mm busbar for the shield connection
- **Busbar 3 x 10 mm**  
To accommodate the shield clamps and the grounding terminal
- **Brake Control Module**  
xB1 or xB2 to control an external electromechanical brake

#### Function

The ET 200S FC is capable of dynamic control procedures such as sensorless vector control or torque control. Where particular speed accuracy and dynamic response requirements exist, a motor encoder can be connected to the control module.

The ET 200S FC is operated without a line reactor.

A PTC or KTY encoder in the motor can be evaluated by the control module to evaluate the motor temperature.

Integral safety functions are selected via the switch-off modules of a series-connected PM-D F:

- Safe Torque Off (STO) to protect against active movement of the drive
- Safely Limited Speed (SLS) to protect against dangerous movements due to exceeded limit speeds.
- Safe Stop 1 (SS1) for continuous monitoring of a safe braking ramp

Neither of the functions "Safe Stop 1" or "Safely Limited Speed" requires a motor encoder or other encoder; the implementation cost is minimal. Existing plants in particular can be updated with safety technology without the need to change the motor or mechanical system. The safety functions "Safely Limited Speed" and "Safe Stop 1" are certified for induction motors without encoders – these safety functions are not permitted for pull-through loads as in the case of lifting gear and winders.

The safety functions of the ET 200S FC are certified according to Category 3 of EN 954-1 and to SIL 2 of IEC 61508.

#### Accessories

The following accessories are available:

- **MMC parameter memory**  
If required, the complete parameter settings of the frequency converter can be saved on a memory card (MMC). When servicing, the plant is immediately ready for use again after replacing the frequency converter and inserting the memory card.

# SIMATIC ET 200S distributed IOs

## ET 200S Safety frequency converters

### ET 200S FC fail-safe frequency converter

#### Technical specifications

	Control unit	Converter Power Modules		
	ICU24F	IPM25, FS A Frame size A	IPM25, FS B Frame size B	
<b>Selection features</b>				
• Integral safety functions according to Category 3 of EN 954-1 or according to SIL2 of IEC 61508	• Safe Torque Off (STO) • Safely Limited Speed (SLS) <sup>1)</sup> • Safe Stop 1 (SS1) <sup>1)</sup>	-	-	
• Output	-	0.75 kW	2.2 kW	4.0 kW
• Rated input current (at 50 °C ambient temperature)	-	1.9 A	5.7 A	9.6 A
• Rated output current (at 50 °C ambient temperature)	-	2.1 A	5.9 A	10.2 A
• Mounting dimensions (W x H x D) in mm (including terminal module)	15 x 220 x 156	65 x 290 x 156	130 x 290 x 156	
<b>Electrical data</b>				
Line voltage	380 V to 480 V 3 AC + 10 %/-10 %			
Line frequency	47 Hz to 63 Hz			
Overload capability	<ul style="list-style-type: none"> <li>• Overload current 1.5 x rated output current (i.e. 150 % overload) for 60 s, cycle time 300 s</li> <li>• Overload current 2 x rated output current (i.e. 200 % overload) for 3 s, cycle time 300 s</li> </ul>			
Output frequency	0 Hz to 650 Hz			
Pulse frequency	8 kHz (standard), 2 kHz to 16 kHz (in 2 kHz steps)			
Standard short circuit current rating SCCR (Short Circuit Current Rating) <sup>2)</sup>	10 kA			
Skipped frequency range	1, programmable			
Converter efficiency	≥96 % at rated load of the motor			
Typical power loss at 420 V input voltage <sup>3)</sup> and motor with rated load (motor and regenerative mode)	10 W	40 W (Pulse frequency 8 kHz) 65 W (Pulse frequency 16 kHz) 30 W (Pulse frequency 4 kHz)	110 W 140 W 80 W	160 W 200 W 130 W
Typical power loss at 420 V input voltage <sup>3)</sup> and motor during no-load operation, 50 Hz	10 W	35 W (Pulse frequency 8 kHz)	70 W	110 W
Interfaces	<ul style="list-style-type: none"> <li>• Connection to PROFIBUS or PROFINET over the ET 200S backplane bus</li> <li>• RS232 interface with USS protocol for commissioning on the PC using the STARTER commissioning software</li> <li>• Activation of the integrated safety functions via PROFIsafe (PM-D F PROFIsafe) or terminals (PM-D F X1)</li> <li>• Slot for an optional memory card (MMC) for uploading or downloading parameter settings</li> <li>• PTC/KTY84 interface (Sub-D connector) for motor temperature monitoring</li> <li>• Speed sensor interface (Sub-D connector) for unipolar HTL incremental position encoder</li> </ul>			
<b>Functions</b>				
Open-loop/closed-loop control procedure	<ul style="list-style-type: none"> <li>• V/f control – linear (<math>M-n</math>) with/without flux current control (FCC), quadratic (<math>M-n^2</math>) or parameterizable</li> <li>• Vector control – with or without encoder</li> <li>• Torque control</li> </ul>			
Operating functions	Jogging mode, free function blocks (FFB), positioning deceleration ramp, automatic restart following interruption due to power failure, bumpless connection of converter to rotating motor			
Braking functions	<ul style="list-style-type: none"> <li>• Regenerative braking operation without brake chopper and pulse resistor</li> <li>• Control of an electromechanical holding brake via an optional Brake Control Module</li> </ul>			
Protective functions	Undervoltage, overvoltage, ground faults, short circuits, stall prevention, motor thermal protection ( $I^2t$ , or sensor) inverter overtemperature, motor blocking protection			
Connectable motors	<ul style="list-style-type: none"> <li>• Low-voltage asynchronous motors</li> <li>• Motor cable lengths: max. 50 m (shielded) max. 100 m (unshielded) If an output reactor or an LC filter is used, longer cable lengths are possible</li> </ul>			
<b>Mechanical data</b>				
Degree of protection	IP20			
Operating temperature	With vertical design of station	-10 °C to +40 °C		
	With horizontal design of station	-10 °C to +50 °C/to +60 °C with derating		
<b>Standards</b>				
Compliance with standards	UL, cUL, CE, c-tick, low-voltage directive 73/23/EEC, EMC directive 89/336/EEC			

<sup>1)</sup> The safety functions "Safely Limited Speed" and "Safe Stop 1" are certified for asynchronous motors without encoders - these safety functions are not permitted for pull-through loads as in the case of lifting gear and winders.

<sup>2)</sup> Applies to industrial control cabinet installations according to NEC Article 409 / UL 508A. Additional information can be found in the Internet under: <http://www.support.automation.siemens.com/ww/view/en/23995621>

<sup>3)</sup> The power loss varies according to the input voltage.

# SIMATIC ET 200S distributed IOs

## ET 200S Safety frequency converters

### ET 200S FC fail-safe frequency converter

#### Technical specifications (continued)

##### Derating data – Pulse frequency

Output kW	Rated output current in A at a pulse frequency of							
	2 kHz	4 kHz	6 kHz	8 kHz	10 kHz	12 kHz	14 kHz	16 kHz
0.75	2.1	2.1	2.1	2.1	1.05	1.05	1.05	1.05
2.2	5.9	5.9	5.9	5.9	5.3	5.3	5.3	5.3
4.0	10.2	10.2	10.2	10.2	5.1	5.1	5.1	5.1

The current data apply to an ambient temperature of 50 °C unless specified otherwise.

#### Selection and Ordering Data

	Version	Order No.
	<b>ICU24F control unit</b> <ul style="list-style-type: none"> <li>Control modes: <math>V/f</math>, FCC, SLVC, VC with encoder, torque control</li> <li>Motor encoder input: HTL unipolar</li> <li>Motor temperature input: PTC/KTY</li> <li>Integrated safety functions</li> </ul>	<b>6SL3244-0SA01-1AA1</b>
	<b>IPM25 converter power module</b> 380 V – 480 V 3 AC +10/-10 % 47 Hz – 63 Hz Overload: 150 % 60 s 200 % 3 s Power: 0.75 kW	<b>6SL3225-0SE17-5UA1</b>
	<b>IPM25 converter power module</b> 380 V – 480 V 3 AC +10/-10 % 47 Hz – 63 Hz Overload: 150 % 60 s 200 % 3 s Power: 2.2 kW 4.0 kW	<b>6SL3225-0SE22-2UA1</b> <b>6SL3225-0SE24-0UA1</b>

## Overview

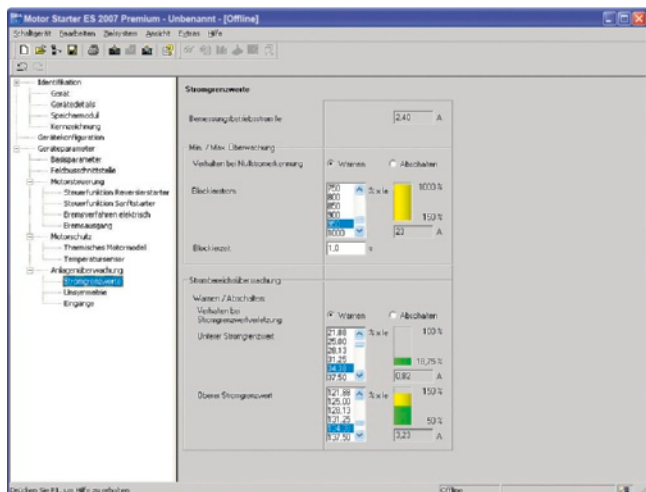

Motor Starter ES for parameterization, monitoring, diagnostics and testing of motor starters

Motor Starter ES is used for start-up, parameterization, diagnostics, documentation and the preventative maintenance of the motor starters in the SIMATIC ET 200S, ET 200pro, ECOFAST and M200D product families.

Interfacing is performed

- Through the local interface on the device
- With PROFIBUS DP V1 capable motor starters from any point in PROFIBUS or in PROFINET (applies for ET 200pro/ ECOFAST/M200D)
- With PROFIBUS-capable motor starters from any point in PROFINET or PROFIBUS (applies for M200D).

Using Motor Starter ES, the communication-capable motor starters are easily parameterized during start-up, monitored during normal operation and successfully diagnosed for service purposes. Preventative maintenance is supported by a function for reading out diverse statistical data (e. g. operating hours, operating cycles, cut-off currents, etc.). The user is supported during these procedures with comprehensive Help functions and plain text displays.

Motor Starter ES provides the following advantages:

- Clearly arranged configuring of device functions and their parameters – online and offline
- Effective diagnostics functions on the soft starter and display of the most important measured values
- Trace function (oscilloscope function) for recording measured values and events (included in the Motor Starter ES Standard and Premium software version for M200D PROFIBUS and PROFINET).

Motor Starter ES can either be used as a stand-alone program or it can be integrated into STEP 7 via an object manager.

**Note:**

The series ET 200S and ET 200pro frequency converters can be programmed very efficiently with the configuring tool STARTER, just like the SINAMICS drives.

[Look up page 4/65 for a description.](#)

### Efficient engineering with new program versions

The Motor Starter ES software program is available in three versions which differ in their user-friendliness, scope of functions and price.

Motor Starter ES	Basic	Standard	Premium
Access through the local interface on the device	✓	✓	✓
Parameter assignment	✓	✓	✓
Operating	✓	✓	✓
Diagnostics	--	✓	✓
Creating templates	--	✓	✓
Comparison functions	--	✓	✓
Standards-conform printout according to EN ISO 7200	--	✓	✓
Service data (slave pointer, statistics data)	--	✓	✓
Access through PROFIBUS	--	--	✓
Access through PROFINET	--	--	✓
S7 Routing	--	--	✓
Teleservice through MPI	--	--	✓
STEP 7 object manager	--	--	✓
Trace function	--	✓ <sup>2)</sup>	✓
✓ Function available	--	Function not available	

Motor Starter ES	Basic	Standard	Premium
ET 200S High Feature PROFIBUS IM	✓	✓	--
ET 200S High Feature PROFINET IM	✓	✓	--
ECOFAST AS-Interface High Feature	✓	✓	--
ECOFAST PROFIBUS	✓	✓	✓
ET 200pro PROFIBUS IM	✓	✓	✓
ET 200pro PROFINET IM	✓	✓	✓
M200D AS-Interface Standard	✓	✓	--
M200D PROFIBUS	✓	✓	✓
M200D PROFINET	✓	✓	✓
✓ Function available	--	Function not available	

### More functions

- Standards-conform printouts  
The software tool greatly simplifies machine documentation. It enables parameterization printouts according to EN ISO 7200. The elements to be printed are easy to select and group as required.
- Easy creation of typicals  
Typicals can be created for devices and applications with only minimum differences in their parameters. These typicals contain all the parameters which are needed for the parameterization. In addition it is possible to specify which of these parameters are fixed and which can be adapted, e.g. by the startup engineer.
- Teleservice through MPI  
The Motor Starter ES Premium version supports the use of MPI Teleservice (comprising the Teleservice software and various Teleservice adapters) for remote diagnostics of the devices. This facilitates diagnostics and maintenance, and it shortens response times for service purposes.

# SIMATIC ET 200S distributed IOs

## ET 200 S - Software

### Motor Starter ES

#### Types of delivery and license

Motor Starter ES is available as follows:

- Floating license – the license for any one user at any one time
  - Authorizes any one user
  - Independent of the number of installations (unlike the single license which is allowed to be installed once only)
  - Only the actual use of the program has to be licensed
  - Trial license (free use of all program functions for 14 days for test and evaluation purposes, included on every product CD, available in the download file of the SIRIUS ES program in the Service&Support portal).

Following delivery versions are also available for Motor Starter ES 2007:

- Upgrade  
Switching from an old to a new version with expanded functions, e.g. upgrade from Motor Starter ES 2006 to Motor Starter ES 2007

- Powerpack  
Special pack for switching within the same software version to a more powerful version with more functionality, e.g. Powerpack Motor Starter ES 2007 for switching from Standard to Premium
- Software Update Service  
To keep you up to date at all times, we offer a special service which supplies you automatically with all service packs and upgrades.
- License Download  
User-friendly license key download from our Mall (currently only for customers from Germany) as an easy and quick way for you to receive additional licenses for your software.

#### System requirements

Parameterization, start-up and diagnostics software Motor Starter ES 2007	
For ECOFAST Motor Starter, SIMATIC ET 200S High-Feature Starter, SIMATIC ET 200pro Starter and M200D (AS-I Standard, PROFIBUS, PROFINET)	
<b>Operating system</b>	Windows XP Professional (Service Pack 2, Service Pack 3), Windows 7 Professional (32 Bit) , Enterprise (32 Bit), Ultimate (32 Bit) Vista Ultimate 32/Business 32 (Service Pack 1)
<b>Processor</b>	≥ Pentium 800 MHz/≥ 1 GHz (Windows 7)
<b>RAM</b>	≥ 512 MB / ≥ 1 GB (Windows 7)
<b>Monitor resolution</b>	≥ 1 024 x 768
<b>Free space on hard disk<sup>1)</sup></b>	≥ 400 MB
<b>CD-ROM/DVD drive</b>	Yes (only when installing from CD)
<b>Serial interface (COM)</b>	Yes
<b>PC cable/parameterization cable/connection cable</b>	Yes
<b>PROFIBUS card/PROFIBUS processor</b>	Optional, for parameterization and diagnostics through PROFIBUS
<b>Ethernet interface/PROFINET card</b>	Optional, for parameterization and diagnostics through PROFINET

<sup>1)</sup> Additional free space recommended, e.g. for swap-out file.

#### Selection and ordering data

##### Parameterization, start-up and diagnostics software Motor Starter ES 2007

For ECOFAST Motor Starter, SIMATIC ET 200S High-Feature Starter, SIMATIC ET 200pro Starter and M200D (AS-I Standard, PROFIBUS, PROFINET)

Version	DT	Order No.
<b>Motor Starter ES 2007 Basic</b>		
<b>Floating license for one user</b> E-SW, software and documentation on CD, 3 languages (German/English/French), communication through system interface		
• License key on USB stick, Class A, including CD	B	<b>3ZS1 310-4CC10-0YA5</b>
• License key download, Class A, no CD	B	<b>3ZS1 310-4CE10-0YB5</b>



Version	DT	Order No.
<b>Motor Starter ES 2007 Standard</b>		
<b>Floating license for one user</b> E-SW, software and documentation on CD, 3 languages (German/English/French), communication through system interface		
• License key on USB stick, Class A, including CD	B	<b>3ZS1 310-5CC10-0YA5</b>
• License key download, Class A, no CD	B	<b>3ZS1 310-5CE10-0YB5</b>
<b>Upgrade for Motor Starter ES 2006</b>	B	<b>3ZS1 310-5CC10-0YE5</b>
Floating license for one user, E-SW, software and documentation on CD, license key on USB stick, Class A, 3 languages (German/English/French), communication through the system interface		
<b>Powerpack for Motor Starter ES 2007 Basic</b>	B	<b>3ZS1 310-5CC10-0YD5</b>
Floating license for one user, E-SW, software and documentation on CD, license key on USB stick, Class A, 3 languages (German/English/French), communication through the system interface		
<b>Software Update Service</b>	B	<b>3ZS1 310-5CC10-0YL5</b>
For 1 year with automatic extension, assuming the current software version is in use, E-SW, software and documentation on CD, communication through the system interface		
<b>Motor Starter ES 2007 Premium</b>		
<b>Floating license for one user</b> E-SW, software and documentation on CD, 3 languages (German/English/French), communication through system interface or PROFIBUS		
• License key on USB stick, Class A, including CD	B	<b>3ZS1 310-6CC10-0YA5</b>
• License key download, Class A, no CD	B	<b>3ZS1 310-6CE10-0YB5</b>
<b>Upgrade for Motor Starter ES 2006</b>	B	<b>3ZS1 310-6CC10-0YE5</b>
Floating license for one user, E-SW, software and documentation on CD, license key on USB stick, Class A, 3 languages (German/English/French), communication through the system interface or PROFIBUS		
<b>Powerpack for Motor Starter ES 2007 Standard</b>	B	<b>3ZS1 310-6CC10-0YD5</b>
Floating license for one user, E-SW, software and documentation on CD, license key on USB stick, Class A, 3 languages (German/English/French), communication through the system interface or PROFIBUS		
<b>Software Update Service</b>	B	<b>3ZS1 310-6CC10-0YL5</b>
For 1 year with automatic extension, assuming the current software version is in use, E-SW, software and documentation on CD, communication through the system interface or PROFIBUS		
<b>Accessories</b>		
<b>For ET 200S High-Feature motor starters</b>		
• Control modules 2DI DC 24 V COM, for ET 200S High-Feature starter, Fail-safe Starter A	A	<b>3RK1 903-0CH10</b>
• LOGO! PC cables	A	<b>6ED1 057-1AA00-0BA0</b>
<b>For ET 200pro and MD200D motor starters</b>		
• RS232 interface cables, serial data connection between ET 200pro MS/FC, M200D and laptop/PC/PG or MS	B	<b>3RK1 922-2BP00</b>

# ET 200pro distributed IOs

## ET 200pro motor starters

### General data

#### Overview



ET 200pro motor starter: Isolator module, Standard starter and High-Feature starter mounted on a wide module rack

#### Motor starters

- Only two variants up to 5.5 kW
- All settings can be parameterized by bus
- Comprehensive diagnostic signals
- Overload can be acknowledged by remote reset
- Current unbalance monitoring
- Stall protection
- Emergency start function in the event of overload
- Current value transmission by bus
- Current limit monitoring
- Direct-on-line or reversing starters
- Power bus can be plugged in using the new HAN Q4/2 plug-in connectors
- Conductor cross-sections up to 6 x 4 mm<sup>2</sup>
- 25 A per segment (power looped through using jumper plug)
- In the Standard and High-Feature versions (with 4 DI onBoard)
- Electromechanical switching and electronic switching
- Electronic starter for direct activation or with integrated smooth-starter function
- Supplied with 400 V AC brake contact as an option

#### Isolator modules

The isolator module with switch disconnecter function is used for safe disconnection of the 400 V operational voltage during repair work in the plant and provides an integrated group fusing function (i.e. additional group short-circuit protection for all subsequently supplied motor starters).

Depending on the power distribution concept, all stations can be equipped with an isolator module as an option.

#### Safety applications

##### Safety local isolator module

With the Safety local modules

- Safety local isolator module and
  - 400 V disconnecting module
- it is possible to achieve safety category 4/SIL 3 with an appropriate connection.

##### Safety Solution PROFIsafe

With the Safety PROFIsafe modules

- F-Switch and
- 400 V disconnecting module

it is likewise possible to achieve safety category 4/SIL 3 with an appropriate connection.

#### Motor Starter ES software

The Motor Starter ES software is used for parameterization, monitoring, diagnostics and testing of motor starters.

[See page 4/29.](#)

### Benefits

- ET 200pro motor starters provide the following advantages:
- High flexibility thanks to a modular and compact design
  - Little variance among all motor starter versions (2 units up to 5.5 kW)
  - Extensive parameterization using STEP 7 HW-Config
  - Increase of plant availability through fast replacement of units (easy mounting and plug-in technology)

- Extensive diagnostics and information for preventive maintenance
- Parameterizable inputs for on-site control functions (High-Feature)
- Cabinet-free construction thanks to high degree of protection IP65.

### Application

With the ET 200pro motor starters, any AC loads can be protected and switched. They are an integral part of ET 200pro and have the high degree of protection IP65. This makes them ideal for operation in modular, distributed peripherals without control cabinets or control enclosures.

The ET 200pro motor starters are available both with mechanical as well as electronic contacts

The ET 200pro electromechanical starters are offered as direct (DSe/DSe) and reversing starters (RSe/RSe) in the High-Feature version with the following equipment:

- 4 digital inputs
- Device versions with or without control for externally fed brakes with 400 V AC
- With expanded parameterization capabilities.

The ET 200pro electronic starters are offered as direct (DSe/DSe) and reversing starters (RSe/RSe) in the High-Feature version with the following equipment:

- 4 digital inputs
- With soft-start and smooth ramp-down function
- With the deactivated smooth start function as an electronic starter for applications with a high level of switching frequency
- Device versions with or without control for externally fed brakes with 400 V AC
- With expanded parameterization capabilities.

As the result of the protection concept with solid-state overload evaluation and the use of SIRIUS controls size S00, additional advantages are realized on the standard and High-Feature motor starters - advantages which soon make themselves positively felt particularly in manufacturing processes with high plant stoppage costs:

- Configuration is made easier by the fine modular structure. When using the ET 200pro motor starters, the list of parts per load feeder is reduced to two main units: the bus module and the motor starter. This makes the ET 200pro ideal for modular machine concepts or solutions for conveying systems and in machine-tool building.
- Expansions are easily possible through the subsequent adding of modules. The innovative plug-in technology also does away with the wiring needed up to now. Through the hot swapping function (disconnection and connection during operation) a motor starter can be replaced within seconds if necessary, without having to shut down the ET 200pro station and with it the process in the plant. The motor starters are therefore recommendable in particular for applications with special demands on availability. Storage costs are optimized in addition by the low level of variance (2 units up to 5.5 kW).

The ordering option for motor starters with a 400 V AC brake output provides the possibility of controlling motors with 400 V AC brakes. With four locally acting inputs available on the High-Feature motor starter it is possible to realize autonomous special functions which work independently of the bus and the higher level control system, e.g. as a quick stop on gate valve controls or limit position disconnectors. In parallel with this, the states of these inputs are signaled to the control system.

When using the optional isolator module with switch disconnect and group fusing function for the ET 200pro, the 400 V supply of the motor starters can be switched on and off directly in the field, i.e. locally.

The Motor Starter ES software is available for the parameterization and diagnostics.  
See [page 4/29](#).

# ET 200pro distributed IOs

## ET 200pro motor starters

Standard motor starters  
High-Feature motor starters

### Selection and ordering data

Version	DT	Order No.
---------	----	-----------

#### Standard motor starters, mechanical Motor protection: thermal model



DSe Standard

##### DSe direct-on-line starters<sup>1)</sup>

- Without brake output
- With brake output 400 V AC

A

3RK1 304-5□S40-4AA0

A

3RK1 304-5□S40-4AA3

##### RSe reversing starters<sup>1)</sup>

- Without brake output
- With brake output 400 V AC

A

3RK1 304-5□S40-5AA0

A

3RK1 304-5□S40-5AA3

#### High-Feature motor starters, mechanical Motor protection: thermal model



RSe High-Feature

##### DSe direct-on-line starters<sup>1)</sup>

- Without brake output and with 4 inputs
- With brake output 400 V AC and 4 inputs

C

3RK1 304-5□S40-2AA0

C

3RK1 304-5□S40-2AA3

##### RSe reversing starters<sup>1)</sup>

- Without brake output and with 4 inputs
- With brake output 400 V AC and 4 inputs

C

3RK1 304-5□S40-3AA0

C

3RK1 304-5□S40-3AA3

Setting range

Rated operational current

- 0.15 ... 2.0 A

K

- 1.5 ... 12.0 A

L

#### High-Feature motor starters, electronic Full motor protection, comprising thermal motor protection and thermis- tor motor protection



sRSSt High-Feature

##### sDSSt/sDSt direct-on-line starters<sup>1)2)</sup>

- Without brake output and with 4 inputs
- With brake output 400 V AC and 4 inputs

C

3RK1 304-5□S70-2AA0

C

3RK1 304-5□S70-2AA3

##### sRSSt/sRSt reversing starters<sup>1)2)</sup>

- Without brake output and with 4 inputs
- With brake output 400 V AC and 4 inputs

C

3RK1 304-5□S70-3AA0

C

3RK1 304-5□S70-3AA3

Setting range

Rated operational current

- 0.15 ... 2.0 A

K

- 1.5 ... 12.0 A

L

x = Additional price

<sup>1)</sup> Only functions when used together with the backplane bus module and the wide module rack. The backplane bus module and the wide module rack must be ordered separately (see "Accessories for ET 200pro motor starters").

<sup>2)</sup> The solid-state motor starters can be used not only as solid-state motor starters with a high level of switching frequency but also as fully fledged soft starters for soft starting and smooth ramp-down. The changeover from motor starter to soft starter takes place through reparameterization in HW Config.

Depending on the setting, this results in the following current ranges:  
- Parameterization as solid-state starter: 0.15 ... 2 A and 1.5 ... 9 A (4 kW)  
- Parameterization as soft starter: 0.15 ... 2 A and 1.5 ... 12 A (5.5 kW).

# ET 200pro distributed IOs

## ET 200pro motor starters

### ET 200pro Safety motor starters Safety modules

#### Overview



ET 200pro motor starter: Safety local isolator module, disconnecting module, Standard starter and High-Feature starter mounted on a wide module rack

#### Safety local isolator module

The Safety local isolator module is a repair switch with integrated safety evaluation functions that can be parameterized using DIP switches.

It is used for:

- Connection of a 1 or 2-channel EMERGENCY-STOP circuit up to Category 3-4/SIL 3 (protective door or EMERGENCY-STOP pushbuttons) and parameterizable start behavior
- Control of the 400 V disconnecting module by means of a safety rail signal

#### 400 V disconnecting module

The 400 V disconnecting module enables the safe disconnection of an operational voltage of 400 V up to Category 3-4/SIL 3. For operation in a Safety Solution local application it functions only in combination with the Safety local isolator module.

For operation in a Safety PROFIsafe application it functions only in combination with the F-Switch.

#### F-Switch

Fail-safe digital inputs/outputs in degree of protection IP65/66/67 for near-machine, cabinet-free use.

##### Fail-safe digital inputs

- For the fail-safe reading in of sensor information (1-/2-channel)
- Including integrated discrepancy evaluation for 2v2 signals
- Internal sensor supplies (incl. testing) available

##### Fail-safe digital outputs

- 3 fail-safe PP-switching outputs for safe switching of the backplane bus bars

The F-Switch is certified up to Category 4 (EN 954-1) and up to SIL 3 (IEC 61508) and has detailed diagnostics.

It supports PROFIsafe in PROFIBUS configurations as well as in PROFINET configurations.

#### Note:

For safety characteristics for motor starters, see Catalog IC 10, "Appendix" --> "Standards and Approvals"

#### Application

##### Safety local isolator module

The Safety local isolator module features the same functions as a standard isolator module with an additional local safety function.

The Safety local isolator module contains a 3TK28 41 module and is equipped with M12 terminals for the connection of external safety components.

Terminals 1 and 2 can be used to connect either 1-channel or 2-channel EMERGENCY-STOP circuits or protective door circuits (IN 1, IN 2).

For monitored starts, an external START switch can be connected to terminal 3.

The required safety functions can be set using 2 slide switches located under the left M12 opening.

In the event of an EMERGENCY-STOP, the Safety local isolator module trips the downstream 400 V disconnecting module. This safely isolates the 400 V circuit up to Category 4/SIL 3.

In combination with the 400 V disconnecting module, the Safety local isolator module can be used for safety applications up to Category 4/SIL 3 according to EN 954-1.

##### 400 V disconnecting module

The 400 V disconnecting module can be used together with the Safety local isolator module for local safety applications and together with the F-Switch for PROFIsafe safety applications.

It contains two contactors connected in series for safety-oriented disconnection of the main circuit.

The auxiliary circuit supply of the device is over a safety power rail in the backplane bus module.

The 400 V disconnecting module can be used together with the Safety local isolator module or with the F-Switch for safety applications up to Category 4/SIL 3 according to EN 954-1.

##### F-Switch



The F-Switch is a fail-safe solid-state module for PROFIsafe safety applications. It has two fail-safe inputs and outputs for safe switching of the 24 V supply over backplane bus bars. In combination with the 400 V disconnecting module it can be used in PROFIsafe applications for the fail-safe disconnection of ET 200pro motor starters up to Category 4/SIL 3.

# ET 200pro distributed IOs

## ET 200pro motor starters



### ET 200pro Safety motor starters Safety modules

#### Selection and ordering data

Version	DT	Order No.
<b>ET 200pro safety modules</b>		
 3RK1 304-0HS00-7AA0	<b>Safety local isolator modules<sup>1)2)</sup></b> Rated operational current 16 A	C <b>3RK1 304-0HS00-7AA0</b>
 3RK1 304-0HS00-8AA0	<b>400 V disconnecting modules<sup>3)4)</sup></b> Rated operational current 25 A	C <b>3RK1 304-0HS00-8AA0</b>
 6ES7 148-1FS00-0AB0	<b>F-Switch PROFIsafe</b> 24 V DC, including bus module Connection module to be ordered separately	A <b>6ES7 148-4FS00-0AB0</b>
	<b>Connection modules for F-Switch</b> 24 V DC	A <b>6ES7 194-4DA00-0AA0</b>

- 1) The Safety local isolator module only functions when used together with the 400 V disconnecting module.
- 2) Only in combination with the special backplane bus module for the Safety local isolator module (see "Accessories for ET 200pro motor starters").
- 3) The 400 V disconnecting module only functions when used together with the Safety local isolator module or with the F-Switch.
- 4) Only functions when used together with the backplane bus module and the wide module rack. The backplane bus module and the wide module rack must be ordered separately (see "Accessories for ET 200pro motor starters").

#### Selection and ordering data

Version	DT	Order No.
<b>ET 200pro isolator modules, mechanical</b>		
 <b>Isolator modules<sup>1)</sup></b> Rated operational current 25 A  3RK1 304-0HS00-6AA0	A	<b>3RK1 304-0HS00-6AA0</b>
 <b>Safety local isolator modules<sup>2)3)</sup></b> Rated operational current 16 A  3RK1 304-0HS00-7AA0	C	<b>3RK1 304-0HS00-7AA0</b>

<sup>1)</sup> Only functions when used together with the related 110 mm backplane bus module and the wide module rack. The backplane bus module and the wide module rack must be ordered separately (see "Accessories for ET 200pro motor starters").

<sup>2)</sup> The Safety local isolator module only functions when used together with the 400 V disconnecting module.

<sup>3)</sup> Only in combination with the special backplane bus module for the Safety local isolator module (see "Accessories for ET 200pro motor starters").

# ET 200pro distributed IOs

## ET 200pro motor starters

### Accessories for ET 200pro motor starters

#### Overview

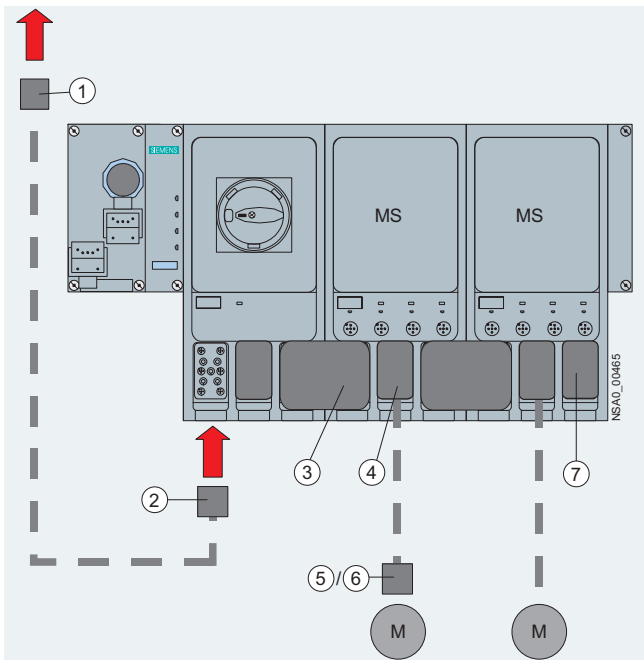

Basic design of an ET 200pro motor starter

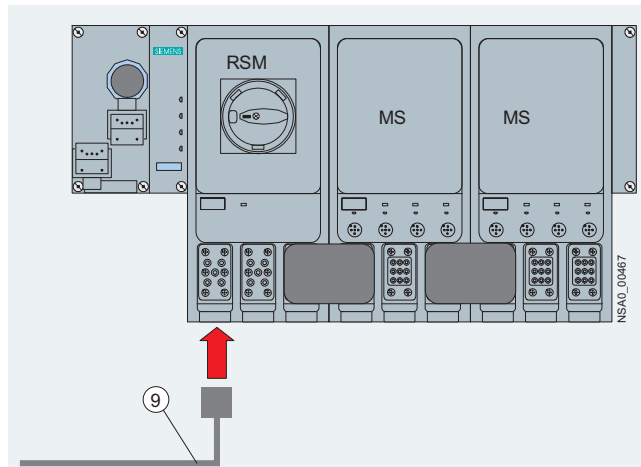

Infeed on the RSM isolator module

Legend:

- ① Power feeder plug (see page 4/39)
- ② Power connection plug (see page 4/39)
- ③ Power jumper plug (see page 4/39)
- ④ Motor connection plug (see page 4/39)
- ⑤ Motor plug (see page 4/39)
- ⑥ Motor plug with EMC suppressor circuit (see page 4/39)
- ⑦ Power loop-through plug (see page 4/39)
- ⑧ Power connection cable (see page 4/39)
- ⑨ Power connection cable for isolator modules (see page 4/39)
- ⑩ Motor cable (see page 4/40)

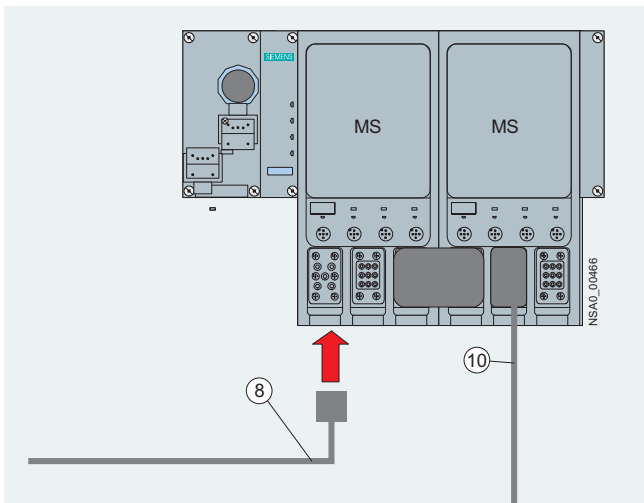

Infeed on the ET 200pro motor starter



#### Selection and ordering data

Version	DT	Order No.
<b>ET 200pro accessories</b>		
<b>① Power feeder plugs</b> Connector set for energy supply, e.g. for connecting to T terminal connectors, comprising a coupling enclosure, straight outgoing feeder (with bracket), pin insert for HAN Q4/2, incl. gland <ul style="list-style-type: none"> <li>• 5 male contacts 2.5 mm<sup>2</sup></li> <li>• 5 male contacts 4 mm<sup>2</sup></li> <li>• 5 male contacts 6 mm<sup>2</sup></li> </ul>	B B B	<b>3RK1 911-2BS60</b> <b>3RK1 911-2BS20</b> <b>3RK1 911-2BS40</b>
<b>② Power connection plugs</b> Connector set for energy supply for connection to ET 200pro motor starters/ET 200pro isolator modules, comprising a cable-end connector hood, angled outgoing feeder, female insert for HAN Q4/2, incl. gland <ul style="list-style-type: none"> <li>• 5 female contacts 2.5 mm<sup>2</sup></li> <li>• 5 female contacts 4 mm<sup>2</sup></li> <li>• 5 female contacts 6 mm<sup>2</sup></li> </ul>	C B B	<b>3RK1 911-2BE50</b> <b>3RK1 911-2BE10</b> <b>3RK1 911-2BE30</b>
<b>③ Power jumper plugs</b>	B	<b>3RK1 922-2BQ00</b>
<b>④ Motor connection plugs</b> Connector set for motor cable for connection to ET 200pro motor starters, comprising a cable-end connector hood, angular outgoing feeder, pin insert for HAN Q8/0, incl. gland <ul style="list-style-type: none"> <li>• 8 male contacts 1.5 mm<sup>2</sup></li> <li>• 6 male contacts 2.5 mm<sup>2</sup></li> </ul>	B B	<b>3RK1 902-0CE00</b> <b>3RK1 902-0CC00</b>
<b>⑤ Motor plugs</b> Connector set for motor cable for connection to motors, comprising a cable-end connector hood, straight outgoing feeder, female insert for HAN 10e, incl. star jumper, incl. gland <ul style="list-style-type: none"> <li>• 7 female contacts 1.5 mm<sup>2</sup></li> <li>• 7 female contacts 2.5 mm<sup>2</sup></li> </ul>	C C	<b>3RK1 911-2BM21</b> <b>3RK1 911-2BM22</b>
<b>⑥ Motor plugs with EMC suppressor circuit</b> Connector set for motor cable for connection to motors, comprising a cable-end connector hood, straight outgoing feeder, female insert for HAN 10e with EMC suppressor circuit, incl. star jumper, incl. gland <ul style="list-style-type: none"> <li>• 7 female contacts 1.5 mm<sup>2</sup></li> <li>• 7 female contacts 2.5 mm<sup>2</sup></li> </ul>	C C	<b>3RK1 911-2BL21</b> <b>3RK1 911-2BL22</b>
<b>⑦ Power loop-through plugs</b> Connector set for power loop-through for connection to ET 200pro motor starters/ET 200pro isolator modules, comprising a cable-end connector hood, angled outgoing feeder, pin insert for HAN Q4/2, incl. gland <ul style="list-style-type: none"> <li>• 4 male contacts 2.5 mm<sup>2</sup></li> <li>• 4 male contacts 4 mm<sup>2</sup></li> </ul>	B B	<b>3RK1 911-2BF50</b> <b>3RK1 911-2BF10</b>
<b>⑧ Power connection cables, assembled at one end</b> Power connection cable for ET 200pro motor starters, ECOFAST, open at one end, for HAN Q4/2, angled, insert turned at isolator module end, 4 x 4 mm <sup>2</sup> <ul style="list-style-type: none"> <li>• Length 1.5 m</li> <li>• Length 5.0 m</li> </ul>	B B	<b>3RK1 911-0DB13</b> <b>3RK1 911-0DB33</b>
<b>⑨ Power connection cables for isolator modules, assembled at one end</b> Power connection cable for ET 200pro isolator modules, open at one end, for HAN Q4/2, angled, insert turned at isolator module end, 4 x 4 mm <sup>2</sup> <ul style="list-style-type: none"> <li>• Length 1.5 m</li> <li>• Length 5.0 m</li> </ul>	C C	<b>3RK1 911-0DF13</b> <b>3RK1 911-0DF33</b>

# ET 200pro distributed IOs

## ET 200pro motor starters

### Accessories for ET 200pro motor starters

Version	DT	Order No.
<b>⑩ Motor cables, assembled at one end</b> Open at one end, HAN Q8, angled, length 5 m		
<ul style="list-style-type: none"> <li>Motor cable for motor without brake, for ET 200pro, ET 200X, AS-i Compact, 4 x 1.5 mm<sup>2</sup></li> </ul>	C	<b>3RK1 911-0EB31</b>
<ul style="list-style-type: none"> <li>Motor cable for motor with brake, for ET 200pro, 6 x 1.5mm<sup>2</sup></li> </ul>	C	<b>3RK1 911-0ED31</b>

Solution Partner

Automation

SIEMENS

More connection technology products can be found at our "Siemens Solution Partners" [www.siemens.com/automation/partnerfinder](http://www.siemens.com/automation/partnerfinder) under "Distributed Field Installation System" technology

Version	DT	Order No.
<b>Module racks, wide<sup>1)</sup></b> <ul style="list-style-type: none"> <li>Length 500 mm</li> <li>Length 1000 mm</li> <li>Length 2000 mm</li> </ul>	A A A	<b>6ES7 194-4GB00-0AA0</b> <b>6ES7 194-4GB60-0AA0</b> <b>6ES7 194-4GB20-0AA0</b>
<b>Module racks, wide, compact<sup>1)</sup></b> <ul style="list-style-type: none"> <li>Length 500 mm</li> <li>Length 1000 mm</li> <li>Length 2000 mm</li> </ul>	A A A	<b>6ES7 194-4GD00-0AA0</b> <b>6ES7 194-4GD10-0AA0</b> <b>6ES7 194-4GD20-0AA0</b>
<b>Backplane bus modules 110 mm<sup>2)</sup></b>	B	<b>3RK1 922-2BA00</b>
<b>Backplane bus modules for Safety local isolator modules</b>	B	<b>3RK1 922-2BA01</b>
<b>RS 232 interface cables</b>	B	<b>3RK1 922-2BP00</b>
<b>Hand-held devices</b> for ET 200pro motor starter, (also for ET 200S High-Feature and ECOFAST), for local operation. A serial interface cable must be ordered separately.	B	<b>3RK1 922-3BA00</b>
<b>Sealing caps (for power supply)</b> (1 pack contains 10 units)	B	<b>3RK1 902-0CJ00</b>
<b>Dismantling tools for HAN Q4/2</b>	C	<b>3RK1 902-0AB00</b>
<b>Crimping tools for pins/sockets 4 mm<sup>2</sup> and 6 mm<sup>2</sup></b>	C	<b>3RK1 902-0CW00</b>
<b>Crimping tools for male contacts and sockets up to 4.0 mm<sup>2</sup> (HAN Q8/0)</b>	B	<b>3RK1 902-0CT00</b>
<b>Dismantling tools for male contacts and sockets (HAN Q8/0)</b>	B	<b>3RK1 902-0AJ00</b>
<b>M12 sealing caps</b> For sealing unused input and output sockets (one set contains ten sealing caps)	▶	<b>3RX9 802-0AA00</b>



3RK1 922-3BA00

4

<sup>1)</sup> The wide module rack can accommodate all ET 200pro motor starters and any optional modules (isolator module, Safety local isolator module and 400 V disconnecting module).

<sup>2)</sup> The backplane bus module is a prerequisite for operation of the ET 200pro motor starter and the optional module.

# ET 200pro distributed IOs

## ET 200pro frequency converters

### ET 200pro FC frequency converters

#### Overview



Standard ET 200pro FC frequency converters and with integrated safety functions

- Two versions with and without integrated safety functions
- Power 1.1 kW (1.5 kW at max. 45 °C ambient temperature)
- Vector control, frequency controller or torque control without sensors
- Integrated brake controller DC 180 V
- Power recovery
- Power looped through using jumper plug with 25 A per segment
- User-friendly parameterization via bus
- Comprehensive diagnostics

#### Benefits

- The frequency converter is completely embedded in the ET 200pro system and provides all the system advantages such as the cabinet-free design, the simple mounting on the module rack, the reduction of the wiring outlay through self-assembling communication and supply rails in the back-plane bus, extensive diagnostic mechanisms and high availability through exchangeability without influencing other modules in the ET 200pro station.
- The load voltage is relayed to the following frequency converters or motor starters with minimum installation costs via pre-assembled jumper plugs. The maximum current carrying capacity of the jumper plug is 25 A.
- Simple combination and expansion of the converter functionality through I/O modules or isolator module inside the distributed station.
- Input for PTC/KTY sensor for comprehensive motor protection.
- The integrated DC 180 V brake controller makes the rectifiers in the motor terminal box redundant.
- Slot for optional memory card (MMC) for saving the parameterization for fast module exchange with automatic reparameterization.
- Types of control available: Frequency control, sensor-less vector control or torque control.
- Parameterizing takes place via STARTER, the graphic parameterizing tool for Siemens operating systems, either via the connected field bus or a point-to-point connection. Note: Access of the STARTER to the frequency converter via the bus is not possible if there is a CPU between the PC and the frequency converter. This also applies for the CPU IM 154-8.
- Active and dynamic braking of the motor is possible without additional outlay. The resulting brake power is fed back into the supply network making brake choppers and pulse resistors unnecessary.
- The fail-safe version of the frequency converter provides autonomous, certified safety functions which contribute to protecting man and machine against dangerous movements in machines. The integration of the safety technology in the operating mechanism also simplifies the machine architecture and allows complete diagnostics.
- Actuation of the fail-safe functions of the local frequency converter with the F-RSM Safety local isolator module or via field bus with the F-Switch PROFI-safe module.

#### Certification

Product group	Product type	Order No.	Category	SIL CL	PL	PFH <sub>D</sub>	Proof Test Interval (years)
SIMATIC ET 200pro	ET 200pro FC	6SL3235-0TE21-1SB0	3	2	PL d	5,00 * 10 <sup>-8</sup>	20

# ET 200pro distributed IOs

## ET 200pro frequency converters

### ET 200pro FC frequency converters

#### Application

- The frequency converter steplessly controls the speed of asynchronous motors.
- The modular, service-friendly concept of the frequency converter makes it particularly suitable for manufacturing processes with high plant stoppage costs.
- The grouping of several frequency converters into a distributed station enables optimum solutions for spatially or functionally adjacent operating mechanisms.
- The frequency converter governs both frequency control for simple applications and vector control for more challenging operating mechanism tasks. It also sees to the optimum actuation of any motor brake that is present.
- The converter also supports torque control, e.g. for applications with mechanically coupled operating mechanisms.
- The advantages of the line-commutated power recovery are shown above all in continuous regenerative mode. Examples of these are unwinders, the lowering of loads or the dynamic braking of large centrifugal masses.
- The integrated safety functions greatly reduce the outlay for operating mechanism solutions in system sections where there is potential danger. Additional savings result through sensor-less monitoring of the speed of standard asynchronous motors.

#### Design



Installation of an ET 200pro station with 2 ET 200pro FC frequency converters with integrated safety functions

The ET 200pro FC comprises the following components:

- Standard ET 200pro FC frequency converters or with integrated safety functions
- Special backplane bus module for accommodating the frequency converter

#### Technical specifications

##### ET 200pro frequency converters with integrated safety functions

###### Selection features

- |   |   |
|---|---|
| <p>Integrated safety functions based on Category 3 of EN 954-1 and SIL 2 of IEC 61508</p> | <ul style="list-style-type: none"> <li>• Safe torque off (STO)</li> <li>• Safely limited speed (SLS)<sup>1)</sup></li> <li>• Safe stop 1 (SS1)<sup>1)</sup></li> <li>• Control of the integrated safety functions via F-RSM Safety local isolator module or via F-Switch PROFIsafe</li> </ul> |
|---|---|

###### Electrical specifications

Mains voltage	3 AC 380 V to 480 V +10 %/-10 %
Power (at 0 °C to 55 °C ambient temperature)	1.1 kW
Rated input current (at 0 °C to 55 °C ambient temperature)	2.0 A
Rated output current (at 0 °C to 55 °C ambient temperature)	3.5 A
Power (at 0 °C to 45 °C ambient temperature)	1.5 kW
Rated input current (at 0 °C to 45 °C ambient temperature)	2.5 A
Rated output current (at 0 °C to 45 °C ambient temperature)	3.9 A
Mains frequency	47 Hz up to 63 Hz
Overload capacity	<ul style="list-style-type: none"> <li>• Overload current 1.5 x rated output current (i.e. 150 % overload) during 60 s cycle time 300 s</li> <li>• Overload current 2 x rated output current (i.e. 200 % overload) during 3 s, cycle time 300 s</li> </ul>
Output frequency	0 Hz up to 650 Hz
Pulse frequency	4 kHz (standard), 2 kHz to 16 kHz (in 2-kHz steps)
Standard short-circuit breaking current SCCR (Short Circuit Current Rating) <sup>2)</sup>	10 kA
Concealable frequency range	1, parameterizable
Converter degree of efficiency	≥96 %
Interfaces	<ul style="list-style-type: none"> <li>• Connection to PROFIBUS (PROFINET available soon) via the ET 200pro backplane bus</li> <li>• Optical interface with USS protocol for RS 232 optical connection cable</li> <li>• Slot for an optional memory card (MMC) for the upload or download of parameter settings</li> <li>• PTC/KTY84 interface for motor temperature monitoring</li> </ul>

# ET 200pro distributed IOs

## ET 200pro frequency converters

### ET 200pro FC frequency converters

#### Technical specifications

ET 200pro frequency converters with integrated safety functions	
<b>Functions</b>	
Control process	<ul style="list-style-type: none"> <li>• <math>U/f</math> controller- linear (<math>M-n</math>) with/without flow current control (FCC), square (<math>M-n^2</math>) or parameterizable</li> <li>• Vector control – without sensor</li> <li>• Torque control</li> </ul>
Operating functions	Inching, free function blocks (FFB), positioning return ramp, automatic restart after operation interrupted by mains failure, surge-free connection of the converter on rotating motor
Brake functions	<ul style="list-style-type: none"> <li>• Regenerative braking operation without brake chopper and pulse resistor</li> <li>• Control of an electromechanical holding brake DC 180 V</li> </ul>
Protection functions	Undervoltage, overvoltage, ground fault, short-circuit, tipping protection, thermal motor protection ( $I^2t$ , or sensor), converter overheating, motor blocking protection
Connectable motors	<ul style="list-style-type: none"> <li>• Low-voltage asynchronous motors</li> <li>• Motor cable length: max. 15 m (shielded)</li> </ul>

ET 200pro frequency converters with integrated safety functions	
<b>Mechanical specifications</b>	
Degree of protection	IP65
Operating temperature	0 °C to +55 °C Performance increase at 0 °C to +45 °C
Mounting position	Vertical wall mounting (vertical alignment of cooling fins)
Mounting dimensions (W x H x D) in mm (including terminal module)	155 x 230 x 213
Weight	4.0 kg
<b>Standards</b>	
Standards conformity	UL, cUL, CE, Low-Voltage Directive 73/23/EU, EMC Directive 89/336/EU



- 1) The "Safely Limited Speed" and "Safe Stop 1" safety functions are certified for asynchronous motors without sensors – these safety functions are not approved for drawing loads such as lifting units and unwinders.
- 2) Applicable for industrial control cabinet installation acc. to NEC Article 409/UL 508A.

You can find more information in the Internet at <http://support.automation.siemens.com/ww/view/en/23995621>

#### Derating data – pulse frequency

Ambient temperature °C	Rated output current in A at a pulse frequency of							
	2 kHz	4 kHz	6 kHz	8 kHz	10 kHz	12 kHz	14 kHz	16 kHz
0...55 (1.1 kW)	3.5	3.5	2.8	2.2	1.6	1.1	0.5	–
0...45 (1.5 kW)	3.9	3.9	3.9	3.9	3.4	3.0	2.6	2.2

#### Selection and ordering data

	Version	Order No.
	<b>ET 200pro frequency converters with integrated safety functions</b> 3 AC 380 V – 480 V +10/-10 % 47 Hz – 63 Hz Overload: 150 %, 60 s, 200 % 3 s Power: 1.1 kW (0 ° ... 55 °C) 1.5 kW (0 ° ... 45 °C)	<b>6SL3235-0TE21-1SB0</b>
	<b>ET 200pro FC standard frequency converters</b> 3 AC 380 V – 480 V +10/-10 % 47 Hz – 63 Hz 150 %, 60 s, 200 % 3 s Power: 1.1 kW (0 ° ... 55 °C) 1.5 kW (0 ° ... 45 °C)	<b>6SL3235-0TE21-1RB0</b>
	<b>Backplane bus module for accommodating the frequency converter</b>	<b>6SL3260-2TA00-0AA0</b>

# ET 200pro distributed IOs

## ET 200pro frequency converters

### ET 200pro FC frequency converters

#### Accessories

Following accessories are available:

Description	Order No.
<b>Connector set</b> for energy supply, HanQ4/2	
<ul style="list-style-type: none"> <li>• 2.5 mm<sup>2</sup></li> <li>• 4.0 mm<sup>2</sup></li> <li>• 6.0 mm<sup>2</sup></li> </ul>	<b>3RK1911-2BE50</b> <b>3RK1911-2BE10</b> <b>3RK1911-2BE30</b>
<b>Prefabricated single-sided motor cable with plug, shielded, HanQ8</b>	
<ul style="list-style-type: none"> <li>• Length 1.5 m</li> <li>• Length 3 m</li> <li>• Length 5 m</li> <li>• Length 10 m</li> </ul>	<b>6ES7194-1LA01-0AA0</b> <b>6ES7194-1LB01-0AA0</b> <b>6ES7194-1LC01-0AA0</b> <b>6ES7194-1LD01-0AA0</b>
<b>Frequency converter plug</b> for motor cable, shielded, HanQ8	<b>6ES7194-1AB01-0XA0</b>
<b>Power jumper plugs</b> for 400-V power loop-through connection to the following 400 V modules	<b>3RK1922-2BQ00</b>
<b>RS 232 interface cables</b> for parameterization of the converter with the STARTER tool via a direct point-to-point connection	<b>3RK1922-2BP00</b>
<b>Memory card (MMC)</b> for the ET 200S FC and ET 200pro FC parameter settings If required there is space on the memory card (MMC) for the complete parameterization of the frequency converter. For service purposes the system is immediately ready for use after replacement of the frequency converter and acceptance of the memory card.	<b>6SL3254-0AM00-0AA0</b>

4

#### Dimensions

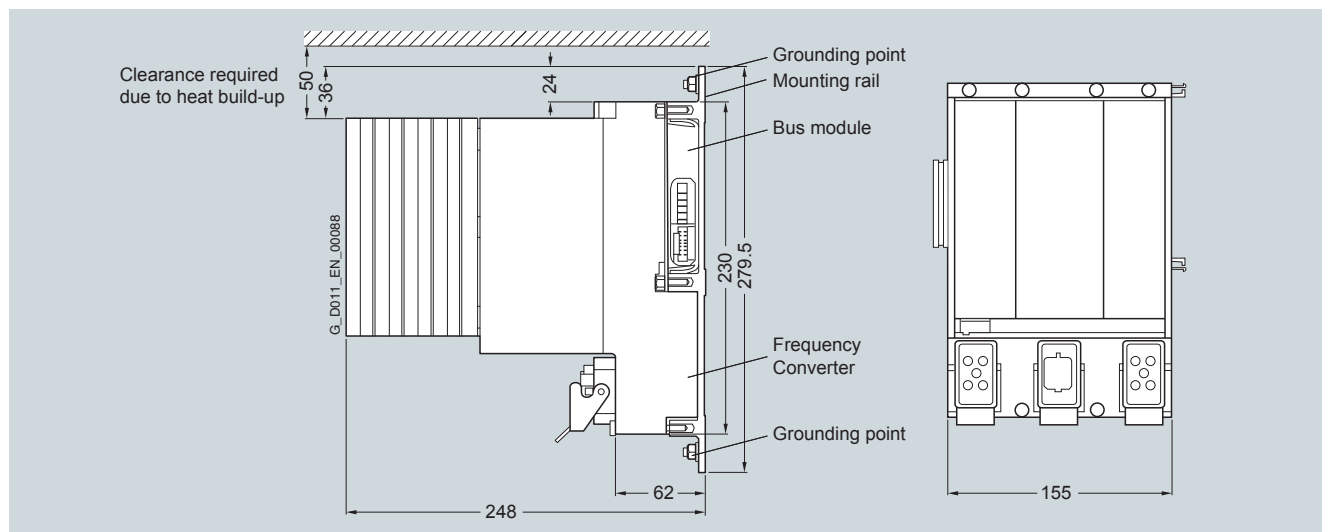

ET 200pro FC frequency converter with backplane bus module and mounting rail



Application areas of the SINAMICS drive family

#### Area of application

SINAMICS is the family of drives from Siemens designed for machine and plant engineering applications. SINAMICS offers solutions for all drive tasks:

- Simple pump and fan applications in the process industry
- Applied single drives in centrifuges, presses, extruders, elevators, as well as conveyor and transport systems
- Drive line-ups in textile, plastic film, and paper machines, as well as in rolling mill plants
- High-precision servo drives for the manufacture of wind turbines
- Highly dynamic servo drives for machine tools, as well as packaging and printing machines

#### Variants

Depending on the application, the SINAMICS range offers the ideal variant for any drive task.

- SINAMICS G is designed for standard applications with asynchronous (induction) motors. These applications have less stringent requirements regarding the dynamic performance of the motor speed.
- SINAMICS S handles complex drive tasks with synchronous and asynchronous (induction) motors and fulfills stringent requirements regarding
  - the dynamic performance and accuracy
  - integration of extensive technological functions in the drive control system
- SINAMICS DCM is the DC drive belonging to the SINAMICS family. As a result of its standard expandability, it addresses both basic as well as demanding drive applications.

#### Platform concept and Totally Integrated Automation

All SINAMICS versions are based on a platform concept. Common hardware and software components, as well as standardized tools for design, configuration and commissioning tasks, ensure high-level integration across all components. SINAMICS handles a wide variety of drive tasks with no system gaps. The different SINAMICS versions can be easily combined with each other.

SINAMICS is a part of the Siemens "Totally Integrated Automation" concept. Integrated SINAMICS systems covering configuration, data management and communication at the automation level, result in extremely cost-effective solutions based on SIMOTION, SINUMERIK and SIMATIC control systems.

# SINAMICS

## Introduction

### The SINAMICS drive family

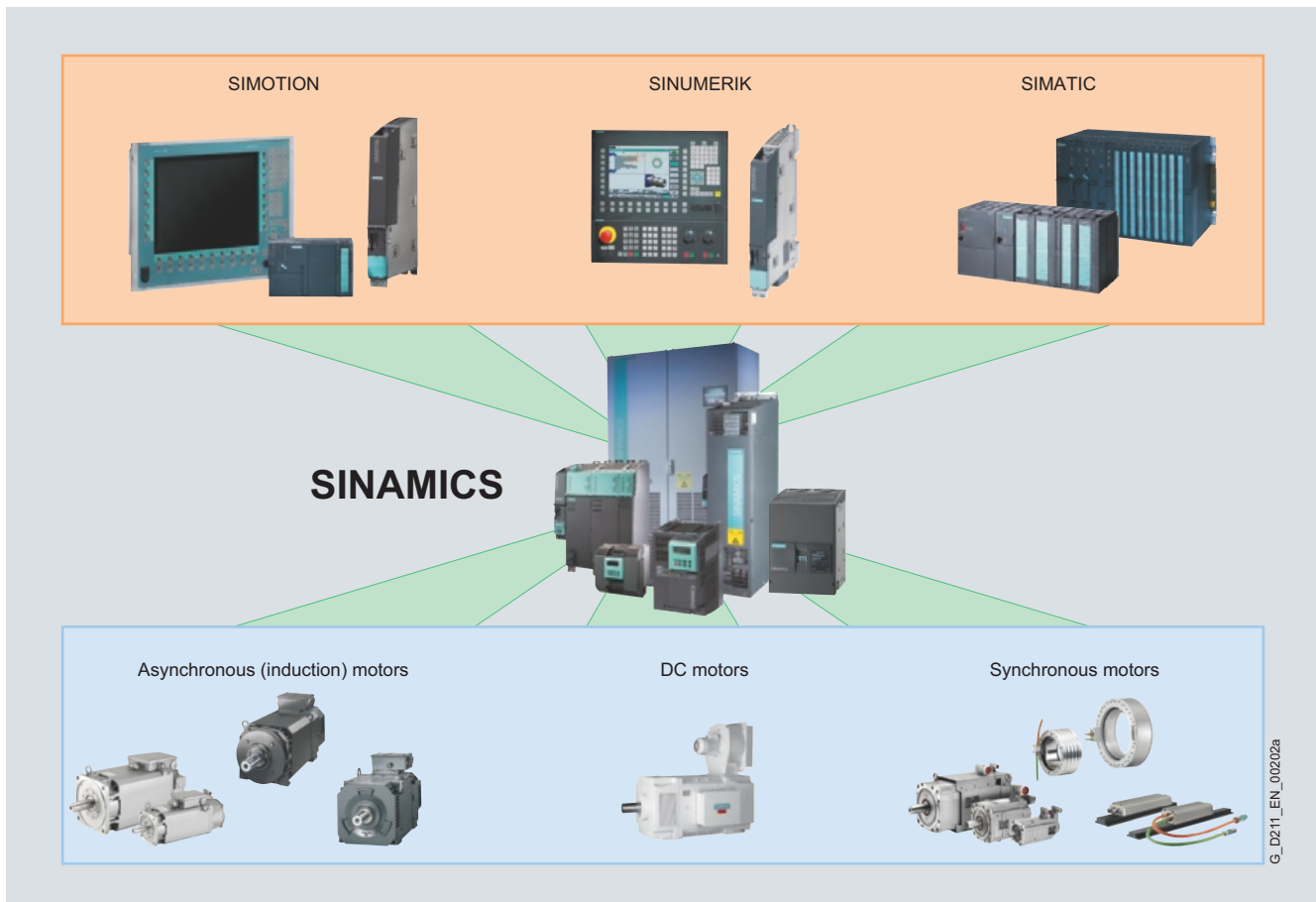

G\_D211\_EN\_00202a

4

SINAMICS as part of the Siemens modular automation system

#### **Quality management according to DIN EN ISO 9001**

SINAMICS conforms to the most exacting quality requirements. Comprehensive quality assurance measures in all development and production processes ensure a consistently high level of quality.

Of course, our quality management system is certified by an independent authority in accordance with DIN EN ISO 9001.

#### **Suitable for global use**

SINAMICS meets the requirements of relevant international standards and regulations – from the EN standards and IEC standards to UL and cULus regulations.

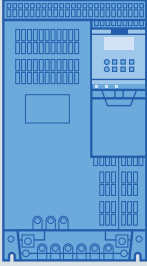
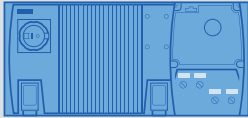
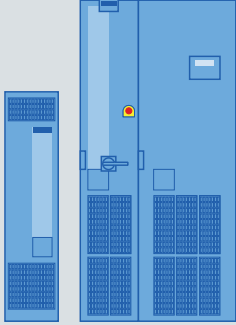

### SINAMICS drives with integrated safety functions

Low voltage AC		
SINAMICS G120	SINAMICS G120D	SINAMICS G130/150
		
<i>For high-quality applications</i>		
V/f control / vector control		
0.37 kW - 250 kW	0.75 kW - 7.5 kW	75 kW - 1500 kW
Pumps, ventilators, conveyor belts, compressors, mixers, mills, extruders		
<i>Shared engineering tools</i>		
<i>SIZER - for simple planning and configuration (see page 4/64)</i>		
<i>STARTER - for fast commissioning, optimization and diagnostics (see page 4/65)</i>		

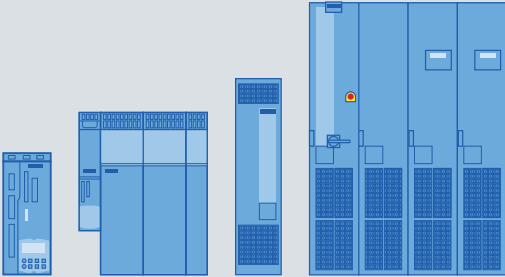
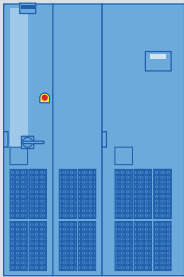
Low voltage AC		
SINAMICS S110	SINAMICS S120	SINAMICS S150
		
<i>For single-axis positioning</i>	<i>For demanding applications</i>	
Servo control	V/f control / vector control / servo control	
0.12 kW - 90 kW	0.12 kW - 4500 kW	75 kW - 1200 kW
Single-axis positioning applications in machine building and plant engineering	Motion Control applications in production machines (packaging, textile, printing, paper, plastic), machine tools, plants and process lines, metal forming technology, renewable energies	Test stands, cross cutters, centrifuges
<i>Shared engineering tools</i>		
<i>SIZER - for simple planning and configuration (see page 4/64)</i>		
<i>STARTER - for fast commissioning, optimization and diagnostics (see page 4/65)</i>		

#### System properties



The SINAMICS range is characterized by the following system properties:

- Uniform functionality based on a single platform concept
- Standardized engineering
- High degree of flexibility and combination capability
- Wide range of performance
- Designed for global use
- SINAMICS Safety Integrated
- Greater efficiency and effectiveness
- High energy efficiency
- Multiple communication options
- Totally Integrated Automation



# SINAMICS

## Introduction

### SINAMICS drives with integrated safety functions

	Drive applications with variable speed		
	SINAMICS G120	SINAMICS G120D	SINAMICS G130 SINAMICS G150
			
	Modular frequency inverter for variable-speed single drives	Modular, distributed frequency inverter for variable-speed single drives	Frequency converter for variable-speed single drives
<b>Main applications</b>	Machines and plants for industrial and commercial applications (mechanical engineering, automotive, textiles, chemicals, printing, steel)	Machines and plants for industrial applications, particularly automotive, but also in airports (wet area without tensides), the food, beverages and tobacco industry, and distribution logistics (e.g. overhead monorail conveyors)	Machines and plants for industrial applications, wherever solid, liquid, or gas substances must be moved, transported, pumped, or compressed
<b>Application examples</b>	<ul style="list-style-type: none"> <li>• Pumps and fans</li> <li>• Compressors</li> <li>• Conveyor systems</li> </ul> in production and process industries	<ul style="list-style-type: none"> <li>• Conveyor technology, above all for high-performance solutions</li> </ul>	<ul style="list-style-type: none"> <li>• Pumps and fans</li> <li>• Compressors</li> <li>• Extruders and mixers</li> <li>• Mills</li> </ul>
<b>Power range</b>	0.37 – 250 kW 0.50 – 340 HP	0.75 – 7.5 kW 1.02 – 10.2 HP	75 – 800 kW / 75 – 1500 kW 102 – 1088 HP / 102 – 2040 HP
<b>Degree of protection</b>	IP20	IP65	IP20 / optional up to IP54 for SINAMICS G150
<b>Regenerative feedback</b>	Yes, optional	Yes	No
<b>Control method</b>			
- V/f control	Yes	Yes	Yes
- Vector control with/without encoder	Yes	Yes	Yes
- Servo control	-	-	-
<b>Motors</b>	Induction motors	Induction motors	Induction and Synchronous motors

### SINAMICS drives with integrated safety functions

	High-performance and motion control applications		
	SINAMICS S110	SINAMICS S120	SINAMICS S150
			
	Single-axis positioning drive	Modular drive system for demanding single or multiple-axis applications	Frequency converter for complex variable-speed single drives
<b>Main applications</b>	Simple positioning tasks with synchronous servo motors and induction motors	Continuous motion control, motion control tasks (including highly dynamic and coordinated positioning tasks) in multi-axis drives with a common, central power supply and intermediate DC circuit	Machines and plants for industrial applications with the most stringent requirements for processes with dynamic and reproducible procedures
<b>Application examples</b>	<ul style="list-style-type: none"> <li>• Handling devices</li> <li>• Feed/extraction equipment</li> <li>• Assembly machines</li> <li>• Positioning axes</li> <li>• Tool changers</li> </ul>	<ul style="list-style-type: none"> <li>• Production machines: Machinery, equipment, and process lines in the packaging, textile, printing, paper, wood, glass, ceramics, and plastics industries</li> <li>• Presses</li> <li>• Converting applications</li> <li>• Handling devices</li> <li>• Paper machines, rolling mills, marine applications</li> </ul>	<ul style="list-style-type: none"> <li>• Test bay drives</li> <li>• Centrifuges</li> <li>• Elevators and cranes</li> <li>• Cross cutters and shears</li> <li>• Conveyor belts</li> <li>• Presses</li> <li>• Cable winches</li> </ul>
<b>Power range</b>	0.12 – 90 kW 0.16 – 122 HP	1.6 – 4500 kW 2 – 6035 HP	75 – 1200 kW 100 – 1609 HP
<b>Degree of protection</b>	IP20	IP20 / optional up to IP54 For cabinet modules	IP20 / optional up to IP54
<b>Regenerative feedback</b>	No	Yes, optional	Yes
<b>Control method</b>			
- V/f control	No	Yes	Yes
- Vector control with/without encoder	No	Yes	Yes
- Servo control	Yes	Yes	Yes
<b>Motors</b>	Induction and synchronous motors	Induction, synchronous, torque, linear motors	Induction, synchronous, torque, linear motors
<b>Additional information</b>	Page 4/82 Catalog PM 22	Page 4/97 Catalog PM 21	Page 4/117 Catalog D21.3

# Safety Integrated with SINAMICS

## The members for the SINAMICS family

### Overview

#### *Legal framework*

Machine manufacturers and plant managers must ensure that their machines or plants cannot cause danger due to malfunctions apart from the general risks.

In Europe, for example, compliance with the machinery directive is required by law in the EU industrial safety directive. In order to ensure the conformity with this directive, it is recommended that the corresponding harmonized European standards are applied. This triggers the presumption of conformity and provides manufacturers and operators with legal certainty in terms of compliance with both national regulations and EU directives. The machine manufacturer uses the CE marking to document the compliance with all relevant directives and regulations in the free movement of goods.

#### *Safety-related standards*

Functional safety is specified in various standards. EN ISO 12100 and EN ISO 14121-1, for example, are concerned with the construction and risk assessment of machines. EN 62061 (only applicable for electrical and electronic control systems) and EN ISO 13849-1, which will replace the extensively used EN 954-1 as from the end of 2011, define the functional and safety-related requirements of control systems with relevance to safety.

The above-mentioned standards define different safety requirements that the machine has to satisfy in accordance with the risk, frequency of a dangerous situation, probability of occurrence and the opportunities for recognizing impending danger:

- EN 954-1: Categories B, 1 ... 4
- EN ISO 13849-1: Performance Level PL a ... e
- EN 62061: Safety Integrity Level SIL 1 ... 3

#### *Trend toward integrated safety systems*

The trend toward greater complexity and increasing modularity of machines have caused the safety functions to move away from the classical central safety functions (for example, deactivation of the complete machine using a main switch) and into the machine control system and the drives. This is often accompanied by a significant increase in productivity because the changeover times are shortened and during this changeover, depending on the type of machine, some subcomponents can even continue to manufacture.

Integrated safety functions act much faster than those of a conventional design. The safety of a machine is increased further with Safety Integrated. Furthermore, safety measures controlled by integrated safety systems are perceived as less interfering by the operator of the machine due to the custom actions, so the motivation to consciously bypass safety functions is significantly reduced.

The integrated safety functions of the SINAMICS drive family provide highly effective application-oriented protection for personnel and machinery.

### Function

#### Safety functions integrated into SINAMICS drives

SINAMICS drives are characterized by a number of integrated Safety functions.

They satisfy the requirements of

- Category 3 according to EN 954-1 or EN ISO 13849-1
- Performance Level (PL) d according to EN ISO 13849-1
- Safety Integrity Level (SIL) 2 according to EN 61508

In addition, the Safety Integrated functions of SINAMICS are generally certified by independent institutes. An up-to-date list of certified components is available on request from your local Siemens office, and under <http://supportautomation.siemens.com>

The Safety Integrated functions currently available in SINAMICS are listed below (terms as defined in IEC 61800-5-2):

#### Safe Torque Off (STO)

##### Description of function

This function prevents the drive from restarting unexpectedly, in accordance with EN 60204-1, Section 5.4. Safe Torque Off disables the drive pulses and disconnects the power supply to the motor (corresponds to Stop Category 0 of EN 60204-1). The drive is reliably torque-free. This state is monitored internally in the drive.

##### Application, customer benefits

STO has the immediate effect that the drive cannot supply any more torque-generating energy. STO can be used wherever the drive will reach a standstill in a sufficiently short time based on the load or friction or when coasting down of the drive will not have any relevance for safety.

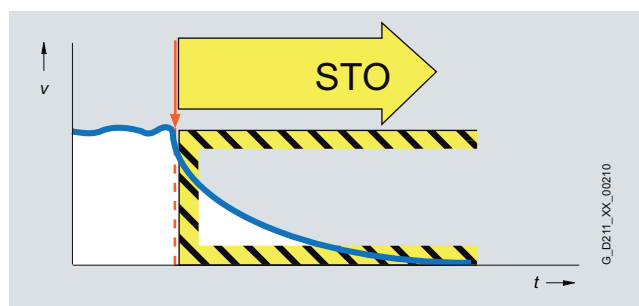

#### Safe Stop 1 (SS1)

##### Description of function

The Safe Stop 1 function can safely stop the drive in accordance with EN 60204-1, Stop Category 1. When the SS1 function is selected, the drive brakes autonomously along a quick-stop ramp (OFF3) and automatically activates the Safe Torque Off and Safe Brake Control functions (if enabled) when the parameterized safety delay time expires.

##### Application, customer benefits

If the drive does not stop sufficiently quickly as a result of load torque when the stop function is activated, it can be actively braked by the converter. With this integrated quick brake function, it is often possible to eliminate mechanical brakes which wear, or to lessen the load on them, so that maintenance costs and the stress on the machine can be reduced.

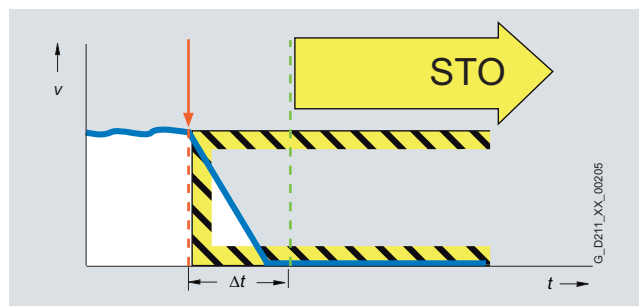

# SINAMICS

## Safety Integrated with SINAMICS

### Safe Brake Control (SBC)

#### Description of function

Safe Brake Control SBC is used to control holding brakes which are operative at zero current, e.g. motor holding brakes. The brake control circuit is a fail-safe, two-channel design.

The Safe Brake Control is activated when the Safe Torque Off function is activated and when safety monitors respond resulting in safe pulse suppression.

- Note 1: Safe Brake Control does not detect mechanical faults in the brake itself, such as worn brake linings.
- Note 2: Motor modules of type SINAMICS S120 Booksize incorporate the terminals for the motor brake. For SINAMICS S120 blocksize an additional Safe Brake Relay is required.

#### Application, customer benefits

In combination with STO and SS1, SBC can also be activated. SBC allows a holding brake to be safely activated on the motor after the torque-generating energy has been shut down, to prevent, for example, sudden drop of suspended axes.

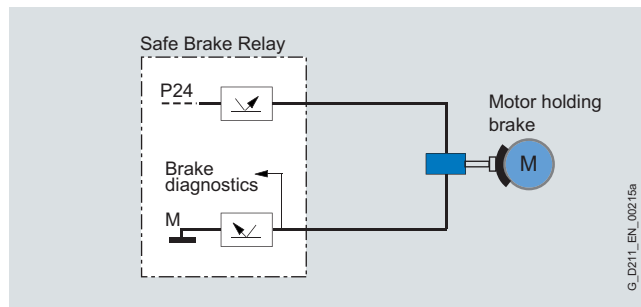

### Safe Stop 2 (SS2)

#### Description of function

The Safe Stop 2 function can safely stop the drive in accordance with EN 60204-1, Stop Category 2. When the SS2 function is selected, the drive brakes autonomously along a quick-stop ramp (OFF3). In contrast to SS1, the automatic speed control remains operational afterwards, i. e. the motor can supply the full torque required to maintain the current position. Standstill is safely monitored (Safe Operating Stop function).

#### Application, customer benefits

As in the case of SS1, the drive is automatically braked when the stop function is selected. In contrast to SS1, the drive can also supply the full torque at standstill.

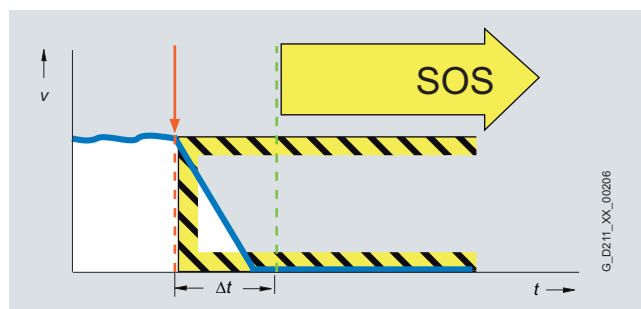

### Safe Operating Stop (SOS)

#### Description of function

The Safe Operating Stop function represents safe standstill monitoring. The drive control remains in operation. The motor can therefore deliver the full torque to hold the current position. The actual position is reliably monitored. In contrast to safety functions SS1 and SS2, the speed setpoint is not influenced automatically. After SOS has been selected, the higher-level control must bring the drive to a standstill within a parameterized safe time  $\Delta t$  and then hold the position setpoint. After the time  $\Delta t$  has elapsed, SOS is activated and monitored to ensure that the current standstill position is not exited.

#### Application, customer benefits

SOS is an ideal solution for applications for which the machine or parts of the machine must be at a safe standstill in certain steps, but the drive must also supply a holding torque. The speed control continues to operate and ensures that the drive remains in its current position despite opposing torques. SOS monitors the current standstill position. When SOS is selected, in contrast to SS1 and SS2, the drive does not influence the speed setpoint autonomously. Conversely, before SOS is activated the higher-level control has the option of ramping down the affected axes in a coordinated manner in the network within a delay time that can be set. This can be used to prevent any damage to the machine or product.

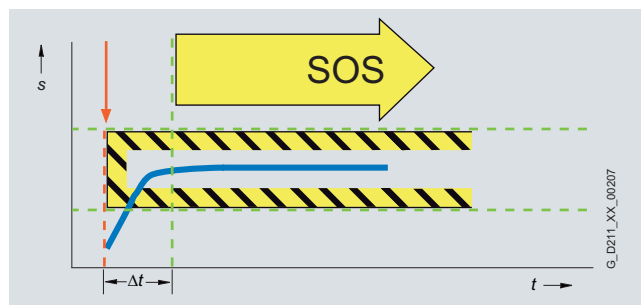

### Safely Limited Speed (SLS)

#### Description of function

The Safely Limited Speed function of SINAMICS G120 and SINAMICS G120D monitors the drive. In addition, depending on the mode selected, it either limits the motor speed to a safe value or monitors the speed directly, keeping it below a parameterizable speed.

SINAMICS S120 does not, by itself, influence the rotation speed set value. Here it is the task of the superimposed controller, after activation of SLS, to diminish the speed of the drives below the selected speed limit and to do this within a predetermined time.

This makes it possible to jointly shut down drives operating in combination, and thus to prevent damage to the devices.

#### Application, customer benefits

When many machines are being set up, the operating personnel must be working on the machine that is in motion. This either occurs step-by-step because the danger area must be exited again and again during starting or the operator is working on the moving machine and is therefore exposed to increased risk.

The SLS function can save a considerable amount of time here and the safety of the operating personnel is assured despite this. The speed of the drive can then be safely limited to a lower speed that is not dangerous.

The adjustable delay time before activation of SLS allows the drive control to ramp down coordinated axes in a defined manner. This can be used to prevent any damage to the product.

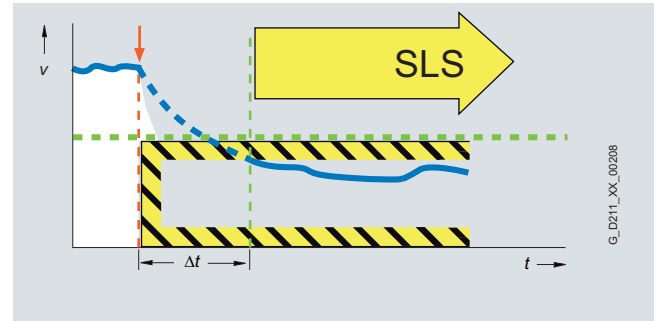

### Safe Speed Monitor (SSM)

#### Description of function

The Safe Speed Monitor function supplies a safe checkback signal (active High), when the drive undershoots a settable speed limit. In contrast to the functions described above, there is no automatic error response from the drive when the limit is overshoot.

#### Application, customer benefits

The safe SSM checkback can be used in a higher-level controller for safety-related responses. As there is no automatic response from the drive to a limit violation, the higher-level safety controller can respond to the alarm flexibly in accordance with the situation. In the simplest case, the SSM signal can be used to release a protective door when a safe speed has been reached.

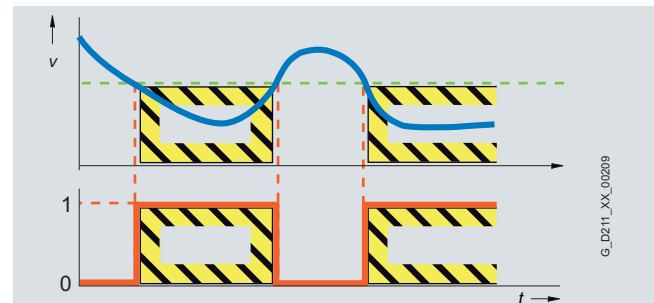

# SINAMICS

## Safety Integrated functions for SINAMICS

### Safety Integrated for SINAMICS G120 and SINAMICS G120D

#### Overview

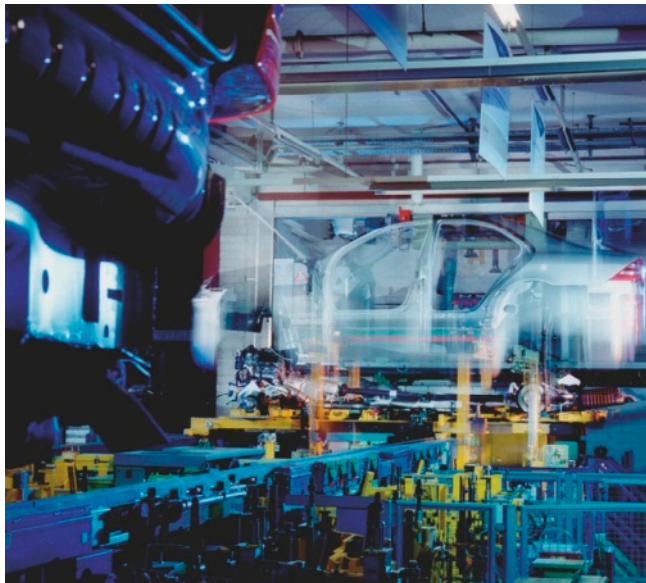

The integrated safety functions of SINAMICS G120 and SINAMICS G120D provide highly effective application-oriented protection for personnel and machinery.

SINAMICS G120 and SINAMICS G120D offer the following Safety Integrated functions (terms as defined in IEC 61800-5-2):

- Safe Torque Off (STO)
- Safe Stop 1 (SS1)
- Safely Limited Speed (SLS)
- Safe Direction (SDI) (G120 only)

The Safety Integrated functions are completely integrated into the drive system. They can be activated as follows:

- via safe digital inputs on the Control Unit (SINAMICS G120 only) without the need for an additional safety relay
- via PROFIBUS with PROFIsafe
- via PROFINET with PROFIsafe

The Safety Integrated functions are implemented electronically and therefore offer short response times in comparison to solutions with externally implemented monitoring functions. This system is absolutely unique worldwide in that it does not require speed feedback through sensors or encoders.

The STO function can be used without restriction for all applications.

The SS1 and SLS functions may be used for any application in which the load can never accelerate when the frequency inverter is switched off. Therefore, they are not suitable for applications with loads that can pull, e.g. lifting gear and winders.

#### Function

##### PROFIsafe

PROFIsafe is an open communications standard that supports standard and safety-related communication over the same communications cable (hard-wired or wireless). A second, separate bus system is therefore not necessary. To ensure safe communication, the transmitted telegrams are continuously monitored. Possible errors, such as lost or repeated telegrams or those received in the wrong order are avoided in that safety-related telegrams are numbered consecutively, their reception is monitored within a defined period, and an identifier for the sender and receiver of a telegram is transferred. A CRC (cyclic redundancy check) data security mechanism is also used.

PROFIsafe can be implemented on PROFIBUS and PROFINET for the SINAMICS G120 and SINAMICS G120D systems.

##### Licensing

The Safety Integrated functions for SINAMICS G120 and SINAMICS G120D do not require a license.

The availability of Safety Integrated functions depends on the type of Control Unit, i.e. whether it is a standard Control Unit or a Fail-safe Control Unit.

An overview of the Safety Integrated functions of SINAMICS G120 and SINAMICS G120D with their secondary conditions is given in the following table:

Function	Activation	Underlying function	Response when a limit value is exceeded	External setpoint input effective	Encoder required
STO	<ul style="list-style-type: none"> <li>• PROFIsafe</li> <li>• Fail-safe digital inputs (with SINAMICS G120 only)</li> </ul>	–	–	no	no
SS1	<ul style="list-style-type: none"> <li>• PROFIsafe</li> <li>• Fail-safe digital inputs (with SINAMICS G120 only)</li> </ul>	STO when 2 Hz is reached	Activation of STO	no	no
SLS	<ul style="list-style-type: none"> <li>• PROFIsafe</li> <li>• Fail-safe digital inputs (with SINAMICS G120 only)</li> </ul>	–	Activation of STO or SS1	yes (depending on mode)	no
SDI	<ul style="list-style-type: none"> <li>• PROFIsafe</li> <li>• Fail-safe digital inputs (with SINAMICS G120 only)</li> </ul>	–	Activation of STO or SS1	yes	no



# SINAMICS Safety Integrated functions for SINAMICS

Safety Integrated for SINAMICS G120 and SINAMICS G120D

## Function

### Comparison between conventional and integrated safety systems

To implement safety functions in conjunction with drives, in some cases complex and costly solutions are required.

These costs are significantly reduced using the safety functions integrated in SINAMICS G120 and SINAMICS G120D.

#### Safe Torque Off (STO)

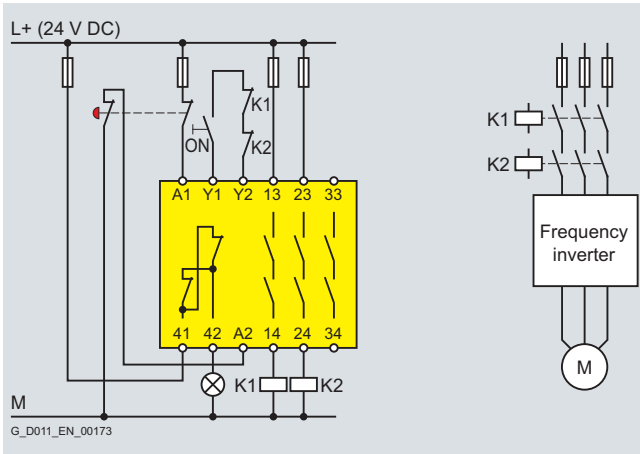

Conventional wiring

#### Safe Stop 1 (SS1)

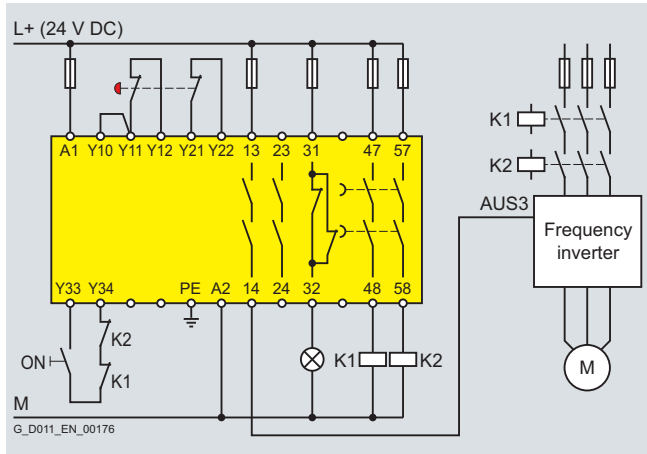

Conventional wiring

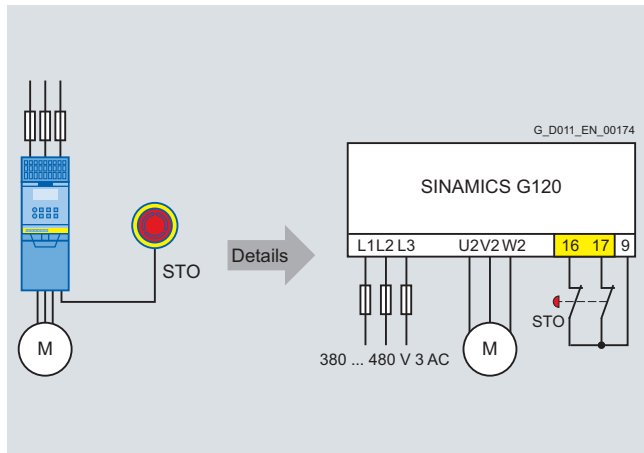

Integrated safety via fail-safe inputs

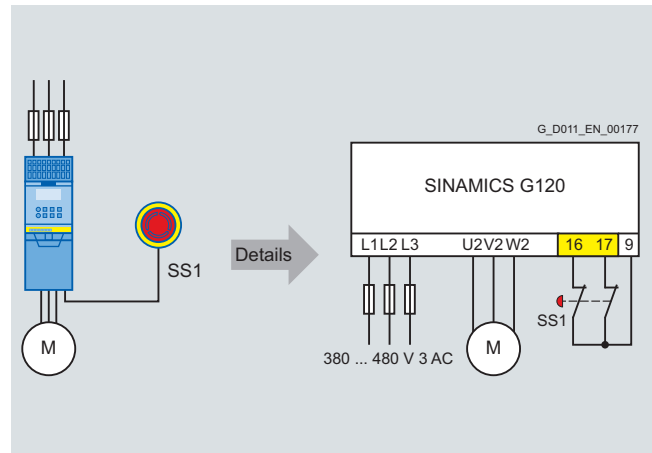

Integrated safety via fail-safe inputs

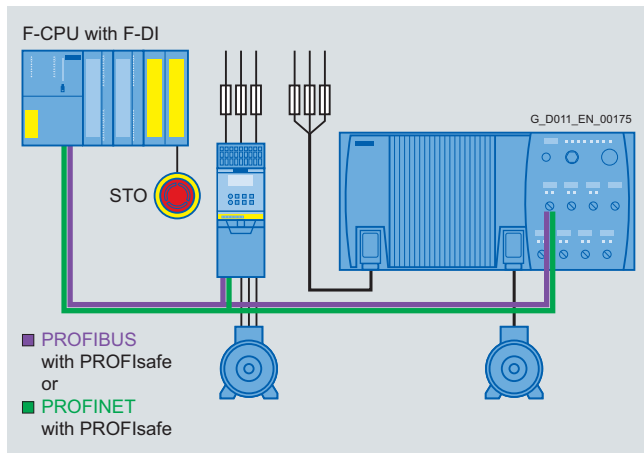

Integrated safety via PROFSafe

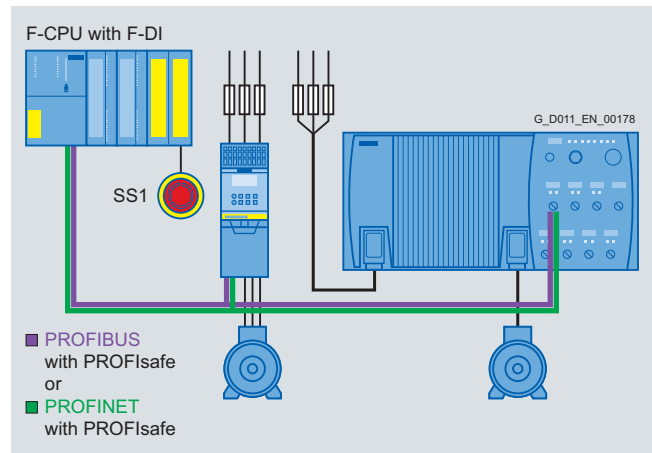

Integrated safety via PROFSafe

# SINAMICS

## Safety Integrated functions for SINAMICS

### Safety Integrated for SINAMICS G120 and SINAMICS G120D

#### Function

#### Safely Limited Speed (SLS)

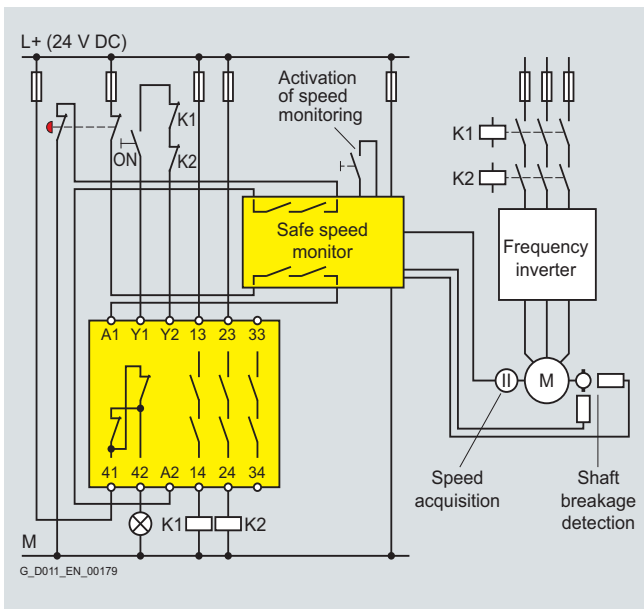

Conventional wiring

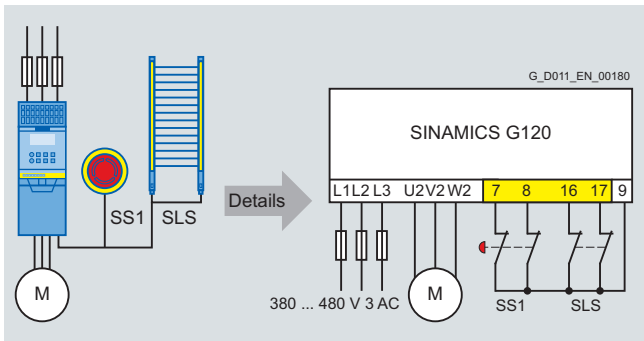

Integrated safety via fail-safe inputs

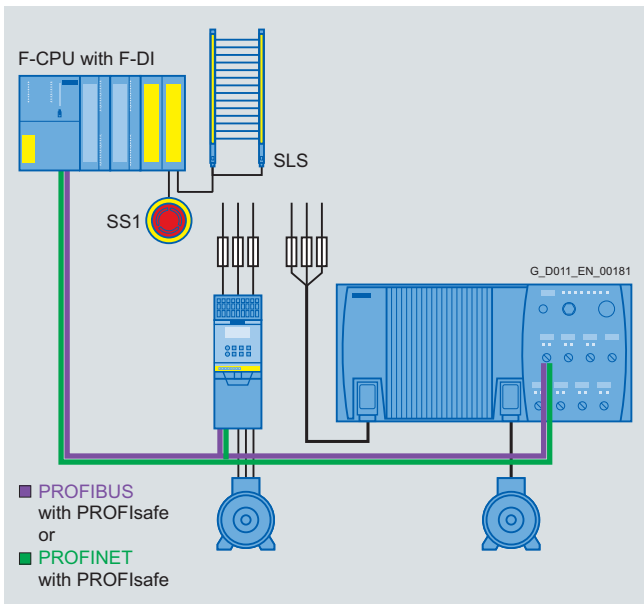

Integrated safety via PROFIsafe

4

**Overview**

SINAMICS G130 and SINAMICS G150 offer the following Safety Integrated functions (terms as defined in IEC 61800-5-2):

- Safe Torque Off (STO)
- Safe Stop 1 (SS1)

The Safety Integrated functions are completely integrated into the drive system. They can be activated as follows:

- via terminals located on the Control Unit and power unit
- via Option K82, for potential-isolated control in a within a voltage range of 24 V - 230 V AC or DC
- via PROFIBUS or PROFINET, with PROFIsafe profile

The Safety Integrated functions are implemented electronically and therefore offer short response times in comparison to solutions with externally implemented monitoring functions.

**Function**

The drive systems SINAMICS G130 and SINAMICS G150 are only available with so-called basic function. These are available to the customer by default and without the need of a licence. Only if the control voltage for the safety functions is higher than 24 V it is required to order option K82.

An overview of the Safety Integrated functions of SINAMICS G130 and SINAMICS G150, plus their boundary conditions is provided in the following table:

Function	Activation	Underlying function	Reaction to limit overshoot	External set-point input effective	Encoder required	Licence required
STO	<ul style="list-style-type: none"> <li>• EP Terminals located at the unit and at the CU</li> </ul>		–	no	no	no
SS1	<ul style="list-style-type: none"> <li>• Terminals located at the unit and at the CU</li> </ul>	STO when pre-set deceleration time is over	–	no	no	no

# SINAMICS

## Safety Integrated functions for SINAMICS

### Safety Integrated for SINAMICS S110

#### Overview

The integrated safety functions of SINAMICS S110 provide highly effective application-oriented protection for personnel and machinery. The current version of SINAMICS S110 offers the following Safety Integrated functions (terms as defined in IEC 61800-5-2):

- Safe Torque Off (STO)
- Safe Brake Control (SBC)
- Safe Stop 1 (SS1)
- Safe Stop 2 (SS2)
- Safe Operating Stop (SOS)
- Safely Limited Speed (SLS)
- Safe Speed Monitor (SSM)
- Safe Direction (SDI)

The Safety Integrated functions are fully integrated into the drive system. They can be activated as follows:

- Via fail-safe digital inputs on the CU305 Control Unit
- PROFIsafe

The Safety Integrated functions are implemented electronically and therefore offer short response times in comparison to solutions with externally implemented monitoring functions.

#### Function

The Safety Integrated functions of the SINAMICS S110 drive system are grouped into Basic Functions and Extended Functions. No license is required for the Basic Functions when activated by the fail-safe terminals on the CU305.

The Extended Functions do require a license. These are activated by means of fail-safe terminals on the CU305 or by means of the safe communication via standard PROFIsafe. When a license is required the MMC memory card for the CU305 is also required.

- **Basic Functions**
  - Safe Torque Off (STO)<sup>1)</sup>
  - Safe Brake Control (SBC)
  - Safe Stop 1 (SS1)
- **Extended Functions**
  - Safe Stop 1 (SS1) with SBR
  - Safe Stop 2 (SS2) with SBR
  - Safe Operating Stop (SOS)
  - Safely Limited Speed (SLS)
  - Safe Speed Monitor (SSM)
  - Safe Direction (SDI)

The functions SS2 and SOS require safe speed/position sensing.

With extended functions SS1 and SS2, safe acceleration monitoring (SAM) is performed during braking to ensure that any faults during braking will be detected. Safe acceleration monitoring requires safe speed/position sensing.

#### Safe speed/position sensing

Incremental encoders or absolute encoders can be used for safe detection of speed or position on a drive. Safe actual value sensing relies on redundant evaluation of the incremental channels A/B that supply sin/cos signals of  $1 V_{pp}$ .

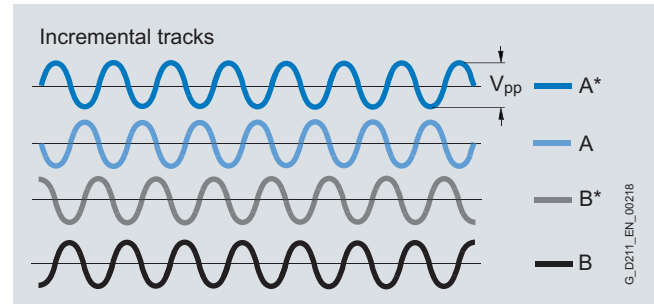

Signal progression for the incremental channels

When motors with a DRIVE-CLiQ interface are used (see synchronous and asynchronous (induction) motors), the speed/position actual values are generated directly in the motor as safe values and transferred to the Control Unit over a safe DRIVE-CLiQ communication link.

For motors without a DRIVE-CLiQ interface, the connection is made using additional Sensor Modules (SMC or SME; see Section SINAMICS S120 in Catalog PM 21).

#### Permissible encoder types

Encoders with photoelectric scanning capability must always be used for safe sensing of actual values. These optical encoders must supply sin/cos signals of  $1 V_{pp}$  on the incremental channels A/B.

Basic absolute encoders (e.g. ECI, EQI) that offer an EnDat interface with additional sin/cos tracks, but operate according to an inductive measuring principle internally, are not permitted.

#### PROFIsafe

PROFIsafe is an open communications standard that supports standard and safety-related communication over the same communications cable (wired or wireless). A second, separate bus system is therefore not necessary. To ensure safe communication, the transmitted message frames are continuously monitored. Possible errors, such as lost or repeated messages or those received in the wrong order etc., are avoided in that safety-related messages are numbered consecutively, their arrival is monitored within a defined period, and an identifier for the sender and receiver of a message is transferred. A CRC (cyclic redundancy check) data security mechanism is also used.

With SINAMICS S110, PROFIsafe is currently only compatible with PROFIBUS. This will be extended to include PROFINET soon.

#### Licensing

The Safety Integrated basic functions do not require a license.

However, the extended functions of Safety Integrated do require a license. It is irrelevant which safety functions are used and how many.

The license can be ordered as an option with the memory card (order code **F01**). For memory card order numbers, please refer to the selection and ordering data.

<sup>1)</sup> The activation option using PROFIsafe currently requires an encoder and a license.

#### Function (continued)

#### Overview of SINAMICS S110 Safety Integrated functions and associated boundary conditions

Function	Activation	Underlying function	Reaction	External set-point input effective	Encoder required	License required
<b>Basic Functions</b>	<b>STO</b>	<ul style="list-style-type: none"> <li>F-DI0 on CU305</li> <li>PROFIsafe</li> </ul>	SBC (if activated)	–	No	No
	<b>SBC</b>	<ul style="list-style-type: none"> <li>With STO (directly or following expiry of the delay with SS1)</li> </ul>	–	–	No	No
	<b>SS1</b>	<ul style="list-style-type: none"> <li>F-DI0 on CU305</li> </ul>	STO following expiry of the parameterized delay, followed by SBC (if activated)	–	No	No
<b>Extended Functions</b>	<b>SS1 (with SBR)</b>	<ul style="list-style-type: none"> <li>F-DI0-2 on CU305</li> <li>PROFIsafe</li> </ul>	Safe acceleration monitoring during braking. STO and SBC (if activated) following expiry of the parameterized delay or speed decay below the minimum speed limit	STO	No	No
	<b>SS2 (with SBR)</b>	<ul style="list-style-type: none"> <li>F-DI0-2 on CU305</li> <li>PROFIsafe</li> </ul>	Safe acceleration monitoring during braking. Following expiry of the parameterized delay SOS	STO	No	Yes
	<b>SOS</b>	<ul style="list-style-type: none"> <li>F-DI0-2 on CU305</li> <li>PROFIsafe</li> </ul>	–	SS1	Yes	Yes
	<b>SLS</b>	<ul style="list-style-type: none"> <li>F-DI0-2 on CU305</li> <li>PROFIsafe</li> </ul>	–	SS1, STO or SOS (parameterizable)	Yes	No
	<b>SSM</b>	<ul style="list-style-type: none"> <li>Always active</li> </ul>	–	Indication only	Yes	No
	<b>SDI</b>	<ul style="list-style-type: none"> <li>F-DI0-2 on CU305</li> <li>PROFIsafe</li> </ul>	–	SS1, STO or SOS (parameterizable)	Yes	No
						Yes

#### The operating principle of Safety Integrated

##### Two independent switch-off signal paths

Two independent switch-off signal paths are available. All switch-off signal paths are low active, thereby ensuring that the system is always switched to a safe state if a component fails or in the event of an open circuit. If an error is discovered in the switch-off signal paths, the Safe Torque Off or Safe Stop 1 function is activated (depending on the parameterization, see the above table) and a system restart inhibited.

##### Two-channel monitoring structure

All the main hardware and software functions for Safety Integrated are implemented in two independent monitoring channels (e.g. switch-off signal paths, data management, data comparison). A cyclic crosswise comparison of the safety-relevant data in the two monitoring channels is carried out.

The monitoring functions in each monitoring channel work on the principle that a defined status must prevail before each action is carried out and a specific acknowledgement must be made after each action. If these expectations of a monitoring channel are not fulfilled, the drive coasts to a standstill (two-channel) and an appropriate message is output.

##### Forced dormant error detection using test stop

The functions and switch-off signal paths must be tested at least once within a defined time in order to meet requirements as per EN 954-1/ISO 13859-1 and IEC 61508 relating to prompt fault detection. This functionality must be implemented by means of test stop triggering either in cyclic manual mode or by the automated process. The test stop cycle is monitored and an alarm is output following a timeout.

A test stop does not require Power On. The acknowledgment is set by canceling the test stop request.

When the appropriate safety devices are implemented (e.g. protective doors), it can be assumed that running machinery will not pose any risk to personnel. For this reason, only an alarm is output to inform the user that a forced dormant error detection run is due, thereby requesting that this be carried out at the next available opportunity.

Examples of when forced dormant error detection runs are required:

- when the drives are at a standstill after the system has been switched on
- before the protective door is opened
- at defined intervals (e.g. every 8 hours)
- in automatic mode, time- and event-driven

# Safety Integrated functions for SINAMICS

## Safety Integrated for SINAMICS S120

### Overview

The integrated Safety functions of SINAMICS S120 provide highly effective application-oriented protection for personnel and machinery.

The current version of SINAMICS S120 offers the following Safety Integrated functions (terms as defined in IEC 61800-5-2):

- Safe Torque Off (STO)
- Safe Brake Control (SBC)
- Safe Stop 1 (SS1)
- Safe Stop 2 (SS2)
- Safe Operating Stop (SOS)
- Safely Limited Speed (SLS)
- Safe Speed Monitor (SSM)
- Safe Direction (SDI)

The Safety Integrated functions are completely integrated into the drive system. They can be activated as follows:

- Over terminals on the Control Unit and on the power unit (STO, SBC, SS1 only)
- Over terminals on the TM54F Terminal Module
- Over PROFIBUS or PROFINET with PROFIsafe profile

The Safety Integrated functions are implemented electronically and therefore offer short response times in comparison to solutions with externally implemented monitoring functions.

SIMOTION provides support for SINAMICS drives that can execute safety-related monitoring functions (SOS, SLS, SDI) or stop reactions (STO, SS1, SS2). This support ensures that limit violations are prevented at the drive end in that SIMOTION controls the drive through the application, for example, within the permissible velocity (with SLS) or brings it to a standstill (with SOS).

The selection and deselection of the functions SS2, SOS, and SLS and their state are indicated by means of specific technological alarms and system variables on the axis.

### Function

#### Basic Functions and Extended Functions

The Safety Integrated functions of the SINAMICS S120 drive system are grouped into Basic Functions and Extended Functions. The Basic Functions are included in the standard scope of supply, so they do not require a license.

A license is however required for each axis before the Extended Functions can be used. The Extended Functions are activated over terminals on the TM54F Terminal Module or over the safe communication of PROFIsafe on PROFIBUS or PROFINET<sup>1)</sup>. The Basic Functions can also be activated via on-board terminals on the device or via PROFIsafe<sup>2)</sup>.

- **Basic Functions**
  - Safe Torque Off (STO)
  - Safe Brake Control (SBC)
  - Safe Stop 1 (SS1)
- **Extended Functions**
  - Safe Stop 1 (SS1) with SBR
  - Safe Stop 2 (SS2) with SBR
  - Safe Operating Stop (SOS)
  - Safely Limited Speed (SLS)
  - Safe Speed Monitor (SSM)
  - Safe Direction (SDI)

With Extended Functions Safe Stop 1 (SS1) and Safe Stop 2 (SS2) with SBR, safe acceleration monitoring (SAM) is performed during braking to ensure that any faults during braking will be detected.

**The Extended Functions are available for Motor Modules in booksize and chassis formats as of Version 3 (last position of Order No. ≥ 3).**

The Basic Functions – activated via on-board terminals on the device or via PROFIsafe – do not require an encoder.

As from SINAMICS firmware version V4.3<sup>3)</sup>, the Extended Functions Safe Stop 1 (SS1) with SBR and Safely Limited Speed are also available without encoder (initially in combination with asynchronous motors only).

In the case of extremely high dynamic requirements, it can be necessary to configure safe speed/position sensing for the functions Safe Stop 1 (SS1) with SBR and Safely Limited Speed. The Extended Functions Safe Stop 2 (SS2) with SBR, Safe Operating Stop and Safe Speed Monitor always require safe speed/position sensing.

#### Licensing

The Safety Integrated Basic Functions do not require a license.

In the case of Safety Integrated Extended Functions, however, a license is required for every axis using these functions. It is of no consequence here which safety functions are used and how many.

The required licenses can be optionally ordered with the CompactFlash Card:

[For the order numbers of the CompactFlash Cards, see Catalog PM 21, sections SINAMICS S120 drive system and SIMOTION D.](#)

**Notes:** On one SIMOTION D4x5 / CX32, up to 5 safety axes are currently possible with Extended Functions. On one CU320-2, up to 6 safety axes are currently possible with Extended Functions.

The CU310 / D410 Control Units have been designed to control only single axes. Only one license is therefore required for the Extended safety functions (order code **F01**).

An overview of the Safety Integrated functions of SINAMICS S120 and their boundary conditions is provided in the following table (see next page):

<sup>1)</sup> PROFIsafe on PROFINET: As from SINAMICS firmware version V2.6; available soon for SIMOTION D.

<sup>2)</sup> As from SINAMICS firmware version V2.6 SP2 or SIMOTION firmware version V4.1 SP4.

<sup>3)</sup> Not available for CU310/D410/D4x5/CX32 (SINAMICS firmware version V2.x).

**Function** (continued)*Overview of SINAMICS S120 Safety Integrated functions and associated boundary conditions*

Functions	Activation	Underlying function	Reaction to limit overshoot	External set-point input effective	Encoder required	License required
<b>STO</b>	<ul style="list-style-type: none"> <li>• EP terminals on the device and on the CU3xx/D4xx/CX32</li> <li>• Terminals on TM54F</li> <li>• PROFIsafe</li> </ul>	SBC (if activated)	–	No	No	No <sup>1)</sup>
<b>SBC</b>	<ul style="list-style-type: none"> <li>• With STO (directly or following expiry of the delay with SS1)</li> </ul>	–	–	–	No	No
<b>SS1</b>	<ul style="list-style-type: none"> <li>• EP terminals on the device and on the CU3xx/D4xx/CX32</li> <li>• PROFIsafe</li> </ul>	STO following expiry of the parameterized delay, SBC (if activated)	–	No	No	No
<b>SS1 with SBR</b>	<ul style="list-style-type: none"> <li>• Terminals on TM54F</li> <li>• PROFIsafe</li> </ul>	Safe acceleration monitoring during braking. STO and SBC (if activated) following expiry of the parameterized delay or under-shooting of the minimum speed limit	STO	No	No <sup>2)</sup>	Yes (per safety axis)
<b>SS2</b>	<ul style="list-style-type: none"> <li>• Terminals on TM54F</li> <li>• PROFIsafe</li> </ul>	Safe acceleration monitoring during braking. Following expiry of the parameterized delay SOS	STO	No	Yes	Yes (per safety axis)
<b>SLS</b>	<ul style="list-style-type: none"> <li>• Terminals on TM54F</li> <li>• PROFIsafe</li> </ul>	–	SS1, STO or SOS (parameterizable)	Yes	No <sup>2)</sup>	Yes (per safety axis)
<b>SOS</b>	<ul style="list-style-type: none"> <li>• Terminals on TM54F</li> <li>• PROFIsafe</li> </ul>	–	SS1/STO	Yes	Yes	Yes (per safety axis)
<b>SSM</b>	Always active	–	Indication only	Yes	No <sup>2)</sup>	Yes (per safety axis)
<b>SDI</b>	<ul style="list-style-type: none"> <li>• Terminals on TM54F</li> <li>• PROFIsafe</li> </ul>	–	SS1, STO or SOS (parameterizable)	Yes	No <sup>2)</sup>	Yes (per safety axis)

<sup>1)</sup> The activation option using terminals on TM54F currently requires a license.

<sup>2)</sup> As from SINAMICS firmware version V4.3; not available for CU310/D410/D4x5/CX32 (SINAMICS firmware version V2.x).

# SINAMICS

## Safety Integrated functions for SINAMICS

### Safety Integrated for SINAMICS S120

#### Safe speed/position sensing

Only incremental encoders or absolute encoders with photoelectric sampling can be used for safe sensing of the position values on a drive. Safe actual value sensing relies on redundant evaluation of the incremental channels A/B that supply sin/cos signals of  $1 V_{pp}$ .

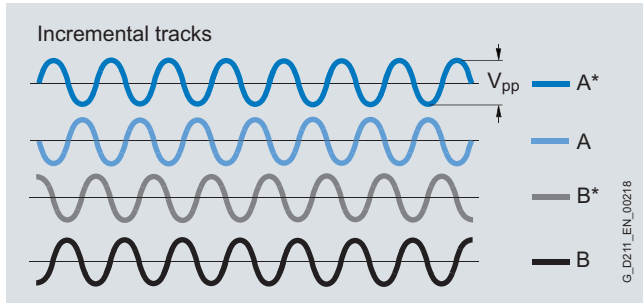

Signal progression for the incremental tracks

When motors with a DRIVE-CLiQ interface are used, the speed/position actual values are generated directly in the motor as safe values and are transferred to the Control Unit over safe communication via DRIVE-CLiQ.

The following can be used for safe speed/position sensing:

- Single-encoder systems or
- Dual-encoder systems

#### Single-encoder system

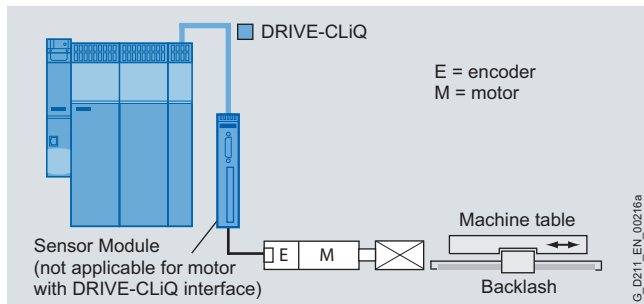

Example of a single-encoder system

In a single-encoder system, the motor encoder is used exclusively for safe actual value sensing.

#### Dual-encoder system

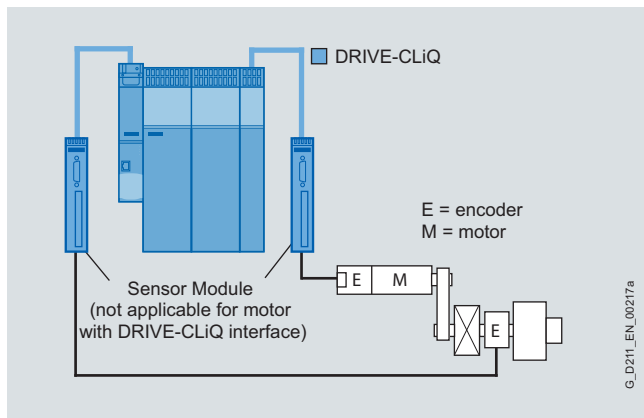

Example of a dual-encoder system on a spindle

The safe actual values for a drive are provided by two separate encoders. The actual values are transferred to the Control Unit over DRIVE-CLiQ. When motors without a DRIVE-CLiQ connection are used, a Sensor Module (SMC/SME) must be implemented. Each measuring system requires a separate DRIVE-CLiQ connection.

#### Further information

Absolute encoders (e. g. ECI, EQI) that offer an EnDat interface with additional sin/cos tracks, but operate according to an inductive measuring principle internally, are not permitted.

For motors without a DRIVE-CLiQ interface, the connection is established by means of additional Sensor Modules:

- SMC20
- SME20/SME25
- SME120/SME125

For descriptions and ordering information of sensor modules look up Catalog PM 21.



**Overview**

The current version of SINAMICS S150 offers the following Safety Integrated functions (terms as defined in IEC 61800-5-2):

- Safe Torque Off (STO)
- Safe Stop 1 (SS1)
- Safe Stop 2 (SS2)
- Safe Operating Stop (SOS)
- Safely Limited Speed (SLS)
- Safe Speed Monitor (SSM)

The Safety Integrated functions are completely integrated into the drive system. They can be activated as follows:

- Over terminals on the Control Unit and on the power unit (STO and SS1)
- via Option K82, for potential-isolated control in a within a voltage range of 24 V - 230 V AC or DC
- Over terminals located on the terminal module "option K87" (TM54F)
- Over PROFIBUS or PROFINET with PROFIsafe profile

The Safety Integrated functions are implemented electronically and therefore offer short response times in comparison to solutions with externally implemented monitoring functions.

**Function**

The Safety Integrated functions of the SINAMICS S150 drive system are grouped into Basic Functions and Extended Functions. The Basic Functions are included in the standard scope of supply, so they do not require a license. Only if the control voltage for the safety functions is higher than 24 V it is required to order option K82.

An overview of the Safety Integrated functions of SINAMICS S150 and their boundary conditions is provided in the following table:

**Overview of SINAMICS S150 Safety Integrated functions and associated boundary conditions**

Functions	Activation	Underlying function	Reaction to limit overshoot	External set-point input effective	Encoder required	License required
<b>STO</b>	<ul style="list-style-type: none"> <li>• EP terminals on the device and on the CU</li> <li>• Terminals on TM54F / option K87</li> <li>• PROFIsafe</li> </ul>	–	–	No	No <sup>1)</sup>	No <sup>2)</sup>
<b>SS1</b> <sup>3)</sup>	<ul style="list-style-type: none"> <li>• Terminals on TM54F / option K87</li> <li>• PROFIsafe</li> </ul>	Safe acceleration monitoring (SBR) during braking. STO and SBC (if activated) following expiry of the parameterized delay or undershooting of the minimum speed limit	STO	No	Yes	Yes (per safety axis)
<b>SS2</b> <sup>3)</sup>	<ul style="list-style-type: none"> <li>• Terminals on TM54F / option K87</li> <li>• PROFIsafe</li> </ul>	Safe acceleration monitoring (SBR) during braking. Following expiry of the parameterized delay SOS	STO	No	Yes	Yes
<b>SLS</b> <sup>3)</sup>	<ul style="list-style-type: none"> <li>• Terminals on TM54F / option K87</li> <li>• PROFIsafe</li> </ul>	–	SS1, STO or SOS (parameterizable)	Yes	Yes	Yes
<b>SOS</b> <sup>3)</sup>	<ul style="list-style-type: none"> <li>• Terminals on TM54F / option K87</li> <li>• PROFIsafe</li> </ul>	–	SS1 or STO (parameterizable)	Yes	Yes	Yes
<b>SSM</b> <sup>3)</sup>	<ul style="list-style-type: none"> <li>• Terminals on TM54F / option K87</li> <li>• PROFIsafe</li> </ul>	–	–	Yes	Yes	Yes

<sup>1)</sup> The activation option using terminals on TM54F currently requires an encoder.

<sup>2)</sup> The activation option using terminals on TM54F currently requires a license.

<sup>3)</sup> Extended safety functions require sin/cos encoders.

# SINAMICS

## Engineering tools

### SIZER configuration tool

#### Overview

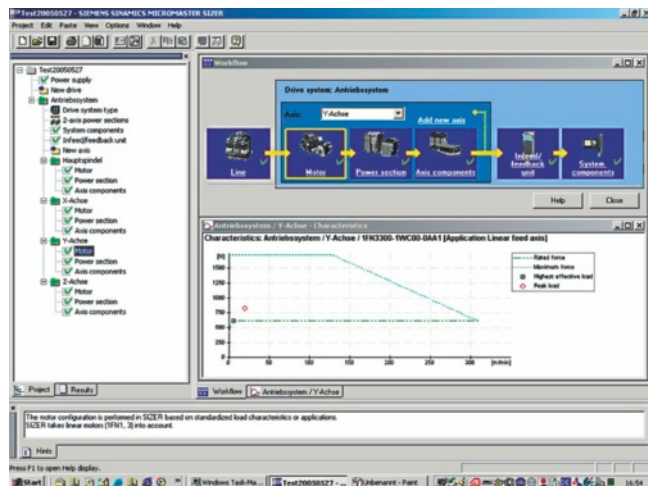

The easy configuration of the following drives and controls is carried out by the configuration tool SIZER:

- drive family SINAMICS
- drive family MICROMASTER 4
- CNC control SINUMERIK solution line
- Motion Controller SIMOTION
- SIMATIC Technology

The tool will support you during the technical configuration of hard- and firmware components required to complete a drive task. SIZER supports the complete configuration of a drive system from simple single drives to multi-axis applications.

SIZER supports all of the engineering steps in one workflow:

- Configuring the power supply
- Designing the motor and gearbox, including calculation of mechanical transmission elements
- Configuring of the drive components
- Selecting the required accessories
- Selecting the line-side and motor-side power options, e.g. cables, filters and reactors

When SIZER was being designed, particular importance was placed on high usability and a universal, function-based approach to the drive task. The extensive user guidance makes using the tool easy. Status information keeps you continually informed of the progress of the configuration process.

The SIZER user interface is available in English, French, German and Italian.

The drive configuration is saved in a project. In the project, the components and functions used are displayed in a hierarchical tree structure.

The project view permits the configuration of drive systems and the copying/inserting/modifying of drives already configured.

The configuration process produces the following results:

- A parts list of the components required (export to Excel, using the Excel data sheet to import in VSR)
- Technical specifications of the system
- Characteristic curves
- Comments on system reactions
- Location diagrams of the drive and control components
- Dimension sheets
- 2-D/3-D models for motors and drive components

These results are displayed in a results tree and can be reused for documentation purposes.

User support is provided by the technological online help menu, which provides the following information:

- Detailed technical data
- Information about the drive systems and their components
- Decision-making criteria for the selection of components
- Online help in Chinese, English, French, German, Italian and Japanese.

#### Minimum system requirements

PG or PC with Pentium II 400 MHz (Windows 2000), Pentium III 500 MHz (Windows XP)

512 MB RAM (1 GB RAM recommended)

At least 2.7 GB of free hard disk space

An additional 100 MB of free hard disk space on Windows system drive

Monitor resolution, 1024 × 768 pixels

Windows 2000 SP4 / XP Professional SP2 / XP Home Edition SP2

Microsoft Internet Explorer 5.5 SP2

#### Selection and ordering data

	Order No.
<b>SIZER configuration tool for SINAMICS</b>	<b>6SL3070-0AA00-0AG0</b>
English, French, German, Italian	

## Overview

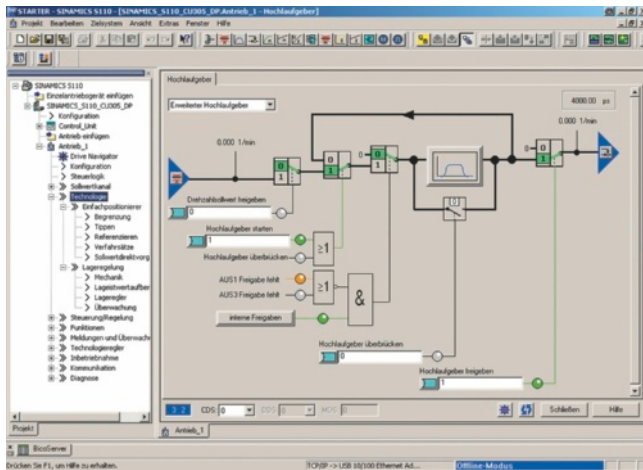

The easy-to-use STARTER drive/commissioning software can be used to:

- commissioning,
- optimization and
- diagnostics

This software can be operated either as a standalone PC application or can be integrated into the SCOUT engineering system (on SIMOTION) or via Drive ES Basic into SIMATIC STEP 7 (TIA-compliant). The basic functions and handling are the same in both cases.

In addition to the SINAMICS drives, the current version of STARTER also supports MICROMASTER 4 devices and inverters for the SIMATIC ET 200S FC distributed I/O system.

The project wizards can be used to create the drives within the structure of the project tree.

First-time users are supported by solution-based dialog menu, whereby a standard graphics-based display maximizes clarity when setting the drive parameters.

First commissioning is guided by wizards, which make all the basic settings in the drive. This enables a drive to be up and running after only setting a small number of parameters within the drive configuration process.

The individual settings required are made using graphics-based parameterization screenforms, which also display the mode of operation.

Examples of individual settings that can be made include:

- terminals
- bus interface
- setpoint channel (e.g. fixed setpoints)
- speed control (e.g. ramp-function generator, limits)
- BICO interconnections
- diagnostics

Experts can gain rapid access to the individual parameters via the expert list and do not have to navigate dialogs.

An individual compilation of frequently used parameters can be saved in individual user lists.

In addition, the following functions are available for optimization purposes:

- self-optimization of controller settings
- trace
- diagnostics functions provide information about:
  - control/status words
  - parameter status
  - operating conditions
  - communication states

### Performance

- Easy to use: Only a small number of settings need to be made for successful first commissioning: axis turning
- Solution-based dialog-based user guidance simplifies commissioning
- Self-optimization functions reduce manual effort for optimization
- The built-in trace function provides optimum support during commissioning, optimization and troubleshooting

### Minimum hardware and software requirements

PG or PC with Pentium II 400 MHz (Windows 2000), Pentium III 500 MHz (Windows XP)

512 MB RAM (1 GB RAM recommended)

Monitor resolution, 1024 × 768 pixels

Windows 2000 SP3, SP4 or XP Professional SP1, SP2 or Windows Server 2003 SP1

Microsoft Internet Explorer 5.01

### Integration

For communication between PG/PC and CU305 a serial RS232-interface, a PROFIBUS or PROFINET (available soon) is used depending on the CU version.

#### Serial (RS232)

In the case of a point-to-point connection to the serial PC-interface, for example, the following zero modem cable can be used:

**Order No.: 6ES7901-1BF00-0XA0**

#### PROFIBUS

For example, PROFIBUS Communications Module CP 5512 (PCMCIA type 2 card + adapter with 9-pole SUB-D socket for connection to PROFIBUS. For Windows 2000/XP Professional and PCMCIA 32)

**Order No.: 6GK1551-2AA00**

and connection cable between CP 5512 and SINAMICS

**Order No.: 6ES7901-4BD00-0XA0**

### Selection and ordering data

	Order No.
<b>STARTER commissioning tool (V4.1.5) for SINAMICS</b>	<b>6SL3072-0AA00-0AG0</b>
English, French, German, Italian, Spanish	

# SINAMICS G120D

## Distributed inverters 0.75 kW to 7.5 kW (1.0 hp to 10 hp)

### SINAMICS G120D distributed inverters

#### Overview

The new SINAMICS G120D distributed frequency inverter series is the solution for demanding drive tasks especially in the field of conveyor systems. SINAMICS G120D inverters continuously control the speed of three-phase asynchronous motors and fulfill all the requirements of conveyor system applications from simple frequency control through to demanding vector control. With its well-thought-out modular design with IP65 degree of protection, it can be seamlessly integrated into the plant or system and supports a high plant availability and low stocks of spare parts. The innovative power unit concept capable of energy recovery helps to save energy. Safety functions that are unique worldwide permit improved plant and system concepts with a higher productivity. This drive can be optimally integrated into the Siemens TIA world of automation via PROFIBUS or PROFINET.

With different device versions (frame sizes FSA to FSC) in a power range from 0.75 kW to 7.5 kW (1.0 hp to 10 hp), it is suitable for a wide variety of drive solutions.



Example: SINAMICS G120D, frame size FSA, comprising PM250D Power Module and Fail-safe CU240D DP-F Control Unit

#### Reasons for using distributed drive systems

- Modular drive solutions – therefore standardized mechatronic elements that can be individually tested
- A control cabinet is not required, resulting in a smaller space requirement and lower cooling requirements
- Long cables between the inverter and motor can be avoided (which means lower power losses, reduced noise emission and lower costs for shielded cables and additional filters)
- Distributed configurations offer considerable benefits for conveyor systems with their extensive coverage (e.g. in the automotive and logistics sectors)

#### Modularity

SINAMICS G120D is a modular inverter system with IP65 degree of protection comprising various function units. The main units are:

- Control Unit (CU)
- Power Module (PM)

The Control Unit controls and monitors the Power Module and the connected motor using several different closed-loop control types that can be selected. The digital inputs and digital outputs on the device support the simple wiring of sensors and actuators directly at the drive. The input signals can either be directly linked within the Control Unit and initiate local responses independently or they can be transferred to the central control via PROFIBUS or PROFINET for processing within the context of the overall plant.

The Power Module supplies the motor in a power range 0.75 kW to 7.5 kW (1.0 hp to 10 hp). The Power Module is controlled by a

microprocessor in the Control Unit. State-of-the-art IGBT technology with pulse-width-modulation is used for highly reliable and flexible motor operation. Comprehensive protection functions provide a high degree of protection for the Power Module and the motor. The unusually low profile mechanical design is optimized so that the device can be directly used in the plant or system. The Power Module also has the same drilling dimensions for all power ratings (one standard footprint).

#### Safety Integrated

The SINAMICS G120D distributed inverters include versions for safety-oriented applications. All Power Modules are already designed for Safety Integrated. A Safety Integrated Drive can be created by combining a Power Module with the relevant Fail-safe Control Unit.

SINAMICS G120D **fail-safe inverter** provides three safety functions, certified in accordance with EN 954-1, Category 3 and IEC 61508 SIL 2:

- Safe Torque Off (STO) to protect against active movement of the drive
- Safe Stop 1 (SS1) for continuous monitoring of a safe braking ramp
- Safely Limited Speed (SLS) for protection against dangerous movements when a speed limit is exceeded

The functions "Safe Stop 1" and "Safely Limited Speed" can both be implemented without having to use a motor encoder or encoder; the implementation cost is minimal. Existing systems in particular can be updated with safety technology without the need to change the motor or mechanical system.

The safety functions "Safely Limited Speed" and "Safe Stop 1" are not certified for pull-through loads such as e.g. hoisting gear and unwinders.

Additional information is provided in the part Highlights, section Safety Integrated (see page 4/54).

#### Efficient Infeed Technology

The advanced Efficient Infeed Technology is employed in PM250D Power Modules. This technology allows the energy produced by motors operating in generator mode connected to standard inverters to be fed back into the supply system. At the same time, considerable savings can be achieved in terms of energy consumption and operating costs.

Additional information is included in the part Highlights, section Efficient Infeed Technology.

#### STARTER commissioning tool

The STARTER commissioning tool (from STARTER Version 4.1, SP1 and higher) supports the commissioning and maintenance of SINAMICS G120D inverters. The operator guidance combined with comprehensive, user-friendly functions for the relevant drive solution allow you to commission the device quickly and easily.

## Certification

Designation	Product type	Order No.	Category	SIL CL	PL	PFH <sub>D</sub>	Proof Test Interval (years)	Notes
SINAMICS G120D	CU240D DP-F	6SL3544-0FA21-1PA0	3	2	PL d	5,00 * 10 <sup>-8</sup>	20	Values include Control Unit and Power Module
	CU240D PN-F	6SL3544-0FA21-1FA0	3	2	PL d	5,00 * 10 <sup>-8</sup>	20	

## Benefits

- Mechanical design, installation and retrofit of a system are significantly simplified as a result of the compact and space-saving design with an extremely low profile and with the same drilling dimensions for all power ratings
- Wide power range from 0.75 kW to 7.5 kW (1.0 hp to 10 hp)
- The safety functions make it easier to integrate drives into safety-oriented machines or plants
- The innovative circuit design (bidirectional input rectifier with "pared-down" DC link) allows the kinetic energy of a load to be fed back into the line supply system. This feedback capability provides enormous potential for energy savings because generated energy no longer has to be converted into heat in a braking resistor. Braking resistors and reactors are not necessary – this is a particular advantage in terms of the space requirement and installation costs for the high IP65 degree of protection
- Increased degree of ruggedness and longer service life as the electronic modules are coated
- Flexibility due to modularity for a future-oriented distributed drive concept with a high IP65 degree of protection
  - Module replacement under voltage (hot swapping)
  - The modules can be easily replaced, which makes the system extremely service friendly
- Communications-capable via PROFINET or PROFIBUS with PROFIdrive Profile 4.0
  - Reduced number of interfaces
  - Plantwide engineering
  - Easy to handle
- The ability to connect up to six sensors and two actuators directly to the Control Unit means that almost all of the drive information can be directly managed; local preprocessing of the signals takes the load off the fieldbus and ensures a fast and reproducible response time
- Integrated class A EMC filter (acc. to EN 55011)
- Integrated brake control, brake voltages that are supported, 400 V AC / 180 V DC
- Integrated motor protection using a thermal motor model and evaluation of PTC, Thermo-Click or KTY 84 temperature sensors
- Software parameters for simple adaptation to 50 Hz or 60 Hz motors (IEC or NEMA motors)
- Easy replacement of devices and fast copying of parameters to the memory card using the optional MMC memory card
- Engineering and commissioning with standard engineering tools such as SIZER (from Version 2.9 and higher), STARTER (from Version 4.1, SP1 and higher) and Drive ES: Ensure fast engineering and easy commissioning – STARTER is integrated in STEP 7 with Drive ES Basic with all the advantages of central data storage and totally integrated communication
- Certified worldwide for compliance with CE, UL, cUL, C-tick and Safety Integrated according to EN 954-1, Category 3 and IEC 61508 SIL 2

## Applications

SINAMICS G120D is ideally suited to demanding conveyor system applications in the industrial environment for which a distributed drive with communications capability is required. This applies in particular to the automotive sector, e.g. assembly lines.

SINAMICS G120D is also suitable for additional high-performance applications, e.g. in the airport sector, food and beverage industry (without tenside) and in distribution logistics (e.g. electric monorail systems).

## Configuration

The following electronic configuring aids and engineering tools are available for the SINAMICS G120D distributed inverters:

*Selection guide, SD Configurator within the DVD catalog CA 01*

More than 100,000 products with approximately 5 million possible product versions from the area of drive technology are listed in the Interactive Catalog CA 01 – the Offline Mall from Siemens IA&DT. In order to make it easier to select the optimum motor and/or inverter from the wide range of Standard Drives, the SD Configurator was developed, which is integrated as "Selection guide" in this catalog on the DVD with the selection and configuration tools.

### Online SD Configurator

In addition, the SD Configurator can now be used on the Internet without requiring any installation. The SD Configurator can be found in the Siemens Mall under the following address:

<http://www.siemens.com/dt-configurator>

### SIZER Configuration Tool (page 4/64)

The SIZER PC tool makes it easy to engineer the SINAMICS and MICROMASTER 4 drive family. It provides support when selecting the hardware and firmware components necessary to implement a drive task. SIZER supports the configuration of the complete drive system and allows simple single-motor drives up to complex multi-axis applications to be engineered. For SINAMICS G120D from SIZER Version 2.9 and higher.

### STARTER Commissioning Tool (page 4/65)

The STARTER commissioning tool allows menu-prompted commissioning, optimization and diagnostics. In addition to SINAMICS drives, STARTER is also suitable for MICROMASTER 4 units and the drive converters for the distributed I/O SIMATIC ET 200S FC and SIMATIC ET 200pro FC. For SINAMICS G120D from STARTER Version 4.1, SP1 and higher.

### Drive ES Engineering System

Drive ES is the engineering system used to integrate the communication, configuration and data management functions of Siemens drive technology into the SIMATIC automation world easily, efficiently and cost-effectively. The STEP 7 Manager user interface forms the basis. A variety of software packages, i.e. Drive ES Basic, Drive ES SIMATIC and Drive ES PCS 7, are available for SINAMICS.

# SINAMICS G120D

## Distributed inverters 0.75 kW to 7.5 kW (1.0 hp to 10 hp)

### SINAMICS G120D distributed inverters

#### Design

The SINAMICS G120D distributed frequency inverters are modular inverters for standard drives. Each SINAMICS G120D comprises two operative units – the Power Module and Control Unit.

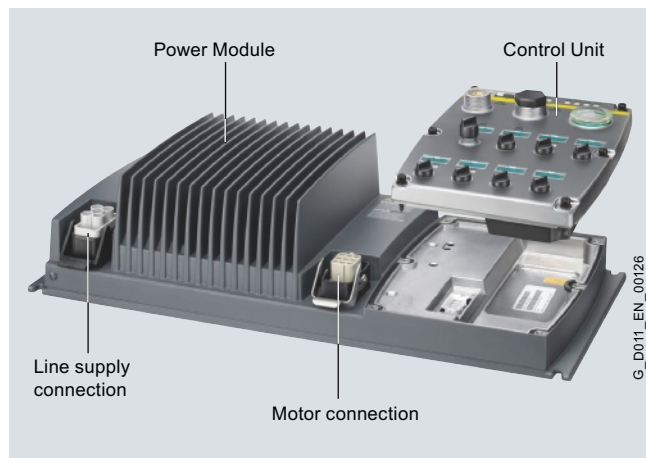

Power Module PM250D with line and motor connections and CU240D Control Unit

#### Power Modules

The following Power Modules are available for the SINAMICS G120D distributed inverters:

##### PM250D Power Modules

PM250D Power Modules (0.75 kW to 7.5 kW/1.0 hp to 10 hp) have an innovative circuit design which allows line-commutated energy recovery back into the line supply. This innovative circuit permits generated energy to be fed back into the supply system and therefore saves energy.

#### Control Units

The following Control Units are available for SINAMICS G120D distributed inverters:

##### CU240D Control Units

The Control Unit performs closed-loop control functions for the inverter. In addition to the closed-loop control, it has additional functions that can be adapted to the particular application through parameterization. Several Control Units are available in different versions:

- CU240D DP
- CU240D DP-F
- CU240D PN
- CU240D PN-F

#### Supplementary System Components

##### Intelligent Operator Panel IOP Handheld

The IOP (Order No. 6SL3255-0AA00-4HA0) supports both entry-level personnel and drive experts. Thanks to the large plain text display, the menu prompting and the Application Wizards, it is easy to commission, diagnose and locally control standard drives.

The IOP Handheld is for use with SINAMICS G120, SINAMICS G110D, SINAMICS G120D, SIMATIC ET 200S FC or SIMATIC ET 200pro FC



Intelligent Operator Panel IOP Handheld

##### MMC memory card

The parameter settings for an inverter can be stored on the MMC memory card. When service is required, e.g. after the inverter has been replaced and the data have been downloaded from the memory card the drive system is immediately ready for use again. The associated slot is located on the rear of the Control Unit.

##### RS232 interface cable for communication with a PC

For controlling and commissioning an inverter directly from a PC if the appropriate software (STARTER commissioning tool from Version 4.1, SP1 and higher) has been installed.

##### USB interface cable for communication with a PC

For controlling and commissioning an inverter directly from a PC if the appropriate software (STARTER commissioning tool from Version 4.1.3 and higher) has been installed.

##### Connecting cable for the Control Units

Flexible plug-in cables to transfer data between the Industrial Ethernet participants or PROFIBUS participants, as well as to supply power to the Control Unit.

##### Connecting cable for the Power Modules

Connector sets to connect to the line supply and the outgoing motor feeder are available as accessories as well as pre-fabricated motor cables for connection to the motor.

##### Spare Parts Kit

A Spare Parts Kit is available which comprises small parts such as seals, caps, PROFIBUS address windows and screws.

##### Replacement fan

A replacement fan is available, which comprises a pre-mounted unit with cover, fan and screws.

# SINAMICS G120D

## Distributed inverters 0.75 kW to 7.5 kW (1.0 hp to 10 hp)

### SINAMICS G120D distributed inverters

#### Technical specifications

Unless explicitly specified otherwise, the following technical specifications are valid for all the following components of the SINAMICS G120D distributed inverter listed here.

SINAMICS G120D	
<b>Mechanical specifications</b>	
<b>Vibratory load according to EN 60068-2-6</b>	
• Transport <sup>1)</sup>	5 ... 9 Hz: Constant deflection, 3.1 mm 9 ... 200 Hz: Constant acceleration = 9.81 m/s <sup>2</sup> (1 × g)
• Operation	10 ... 58 Hz: Constant deflection, 0.15 mm 58 ... 200 Hz: Constant acceleration = 19.62 m/s <sup>2</sup> (2 × g)
<b>Shock load according to EN 60068-2-27</b>	
• Transport <sup>1)</sup>	147.15 m/s <sup>2</sup> (15 × g)/11 ms 3 Shocks in each axis and direction
• Operation	147.15 m/s <sup>2</sup> (15 × g)/11 ms 3 Shocks in each axis and direction
<b>Ambient conditions</b>	
<b>Protection class acc. to EN 61800-5-1</b>	Class III (PELV)
<b>Touch protection according to EN 61800-5-1</b>	Class I (with protective conductor system)
<b>Permissible ambient and coolant temperature (air) during operation for Power Modules</b>	-10 ... +40 °C without derating > 40 ... 55 °C see derating characteristics
<b>Permissible ambient and coolant temperature (air) during operation for Control Units</b>	CU240D DP: -10 ... +55 °C CU240D PN: -10 ... +50 °C CU240D DP-F: 0 ... 55 °C CU240D PN-F: 0 ... 50 °C (> 40 ... 55 °C see derating characteristics) up to 2000 m above sea level
<b>Climatic ambient conditions</b>	
• Storage <sup>1)</sup> acc. to EN 60068-2-1	Temperature -40 ... +70 °C
• Transport <sup>1)</sup> acc. to EN 60068-2-1	Temperature -40 ... +70 °C max. humidity 95 % at 40 °C
• Operation acc. to EN 60068-2-2	Temperature -10 ... +40 °C without derating
<b>Environmental class/harmful chemical substances</b>	
• Operation acc. to EN 60721-3-3	Class 3C2
<b>Degree of pollution acc. to EN 61800-5-1</b>	2
<b>Certification for Fail-safe versions</b>	
• Category acc. to EN 954-1	3
• SIL Cl acc. to IEC 61508	2
• PL acc. to ISO 13849	Available soon
• PFH <sub>D</sub>	5 × 10 <sup>-8</sup>
• T1	10 Years
<b>Standards</b>	
<b>Compliance with standards</b>	UL 508C (UL list number E121068), CE, c-tick
<b>CE mark</b>	According to Low-Voltage Directive 73/23/EEC and Machinery Directive 98/37/EC
<b>EMC Directive <sup>2)</sup></b>	
• Frame sizes FSA to FSC with integrated class A line filter	Category C2 <sup>3)</sup> acc. to EN 61800-3 (corresponds to class A acc. to EN 55011)

**Note:** The EMC product standard EN 61800-3 does not apply directly to a frequency inverter but to a PDS (Power Drive System), which comprises the complete circuitry, motor and cables in addition to the inverter. The frequency inverters on their own do not generally require identification according to the EMC Directive.

#### Note:

Additional information is provided in the section on Safety Integrated, see page 4/54.

<sup>1)</sup> In transport packaging.

<sup>2)</sup> For further general information, see also SINAMICS G110 section Technical specifications, Compliance with standards.

<sup>3)</sup> With shielded motor cable up to 15 m.

# SINAMICS G120D

## Distributed inverters 0.75 kW to 7.5 kW (1.0 hp to 10 hp)

### CU240D Control Units

#### Overview



Example of CU240D DP-F Control Unit



Example of CU240D PN-F Control Unit

The Control Unit performs closed-loop control functions for the inverter. In addition to the closed-loop control, it has additional functions that can be adapted to the particular application through parameterization. Control Units are available in different versions:

- CU240D DP-F
- CU240D PN-F

#### Safety Integrated functions

The SINAMICS G120D fail-safe inverter provides three safety functions, certified in accordance with EN 954-1, Category 3 and IEC 61508 SIL 2:

- Safe Torque Off (STO) to protect against active movement of the drive
- Safe Stop 1 (SS1) for continuous monitoring of a safe braking ramp
- Safely Limited Speed (SLS) for protection against dangerous movements when a speed limit is exceeded

The functions "Safe Stop 1" and "Safely Limited Speed" can both be implemented without a motor encoder or encoder; the implementation cost is minimal. Existing systems in particular can be simply updated with safety technology without the need to change the motor or mechanical system.

The safety functions "Safely Limited Speed" and "Safe Stop 1" are not permitted for pull-through loads such as e.g. hoisting gear and unwinders.

Safety functions have been extended with firmware V3.2.

#### Selection and ordering data

Communication	Digital inputs	Digital outputs	Encoder interfaces	Designation	Control Unit Order No.
<b>Fail-safe for Safety Integrated</b>					
PROFIBUS DP	6	2	1	CU240D DP-F	<b>6SL3544-0FA21-1PA0</b>
PROFINET	6	2	1	CU240D PN-F	<b>6SL3544-0FA21-1FA0</b>



# SINAMICS G120D

## Distributed inverters 0.75 kW to 7.5 kW (1.0 hp to 10 hp)

### CU240D Control Units

#### Design

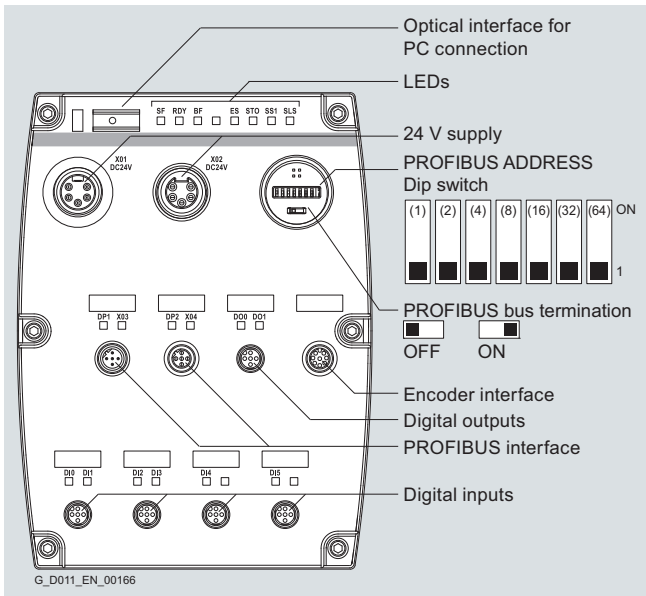

CU240D DP-F Control Unit

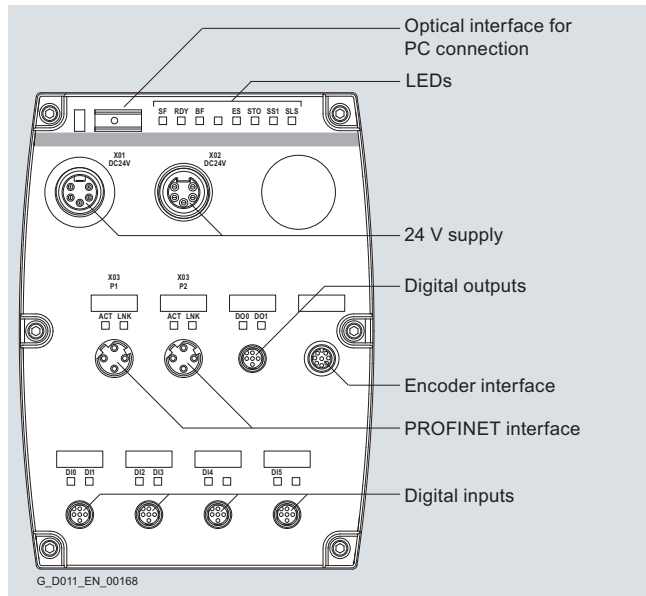

CU240D PN-F Control Unit



Control Unit, view from the rear, MMC slot at the top and PM-IF interface at bottom center

# SINAMICS G120D

## Distributed inverters 0.75 kW to 7.5 kW (1.0 hp to 10 hp)

### CU240D Control Units

#### Technical specifications

Control Unit	CU240D DP-F 6SL3544-0FA21-1PA0	CU240D PN-F 6SL3544-0FA21-1FA0
<b>Electrical specifications</b>		
<b>Operating voltage</b>	external 24 V DC necessary	external 24 V DC necessary
<b>Current consumption <sup>1)</sup></b> (from the 24 V supply)		
• with Power Module frame sizes FSA and FSB	200 mA	350 mA
• with Power Module frame size FSC	350 mA	500 mA
<b>Interfaces</b>		
<b>Digital inputs</b>	6	6
<b>Digital outputs</b> (0.5 A, fed through switched 24 V DC)	2	2
<b>Bus interface</b>	PROFIBUS DP, PROFI-safe	PROFINET, PROFI-safe
<b>Encoder interfaces</b> (HTL incremental interface, bipolar up to 2048 pulses, max. 100 mA)	1	1
<b>PTC/KTY interface</b> (connection via Power Module)	✓	✓
• Motor temperature sensor	1 input, sensors that can be connected: PTC, KTY or Thermo-Click	1 input, sensors that can be connected: PTC, KTY or Thermo-Click
<b>Control of a mechanical motor brake</b> (connection via Power Module)	✓	✓
<b>MMC memory card slot</b>	✓	✓
<b>RS232 interface</b> (connected with RS232 interface cable or USB interface cable via the optical interface of the Control Unit)	✓	✓
<b>Safety functions</b>		
<b>Integrated safety functions</b> Acc. to Category 3 of EN 954-1 and acc. to SIL 2 of IEC 61508	<ul style="list-style-type: none"> <li>• Safe Stop 1 (SS1)</li> <li>• Safely Limited Speed (SLS)</li> <li>• Safe Torque Off (STO)</li> <li>• The safety functions "Safely Limited Speed" and "Safe Stop 1" are not certified for pull-through loads such as e.g. hoisting gear and unwinders.</li> </ul>	<ul style="list-style-type: none"> <li>• Safe Stop 1 (SS1)</li> <li>• Safely Limited Speed (SLS)</li> <li>• Safe Torque Off (STO)</li> <li>• The safety functions "Safely Limited Speed" and "Safe Stop 1" are not certified for pull-through loads such as e.g. hoisting gear and unwinders.</li> </ul>
<b>Open-loop/closed-loop control techniques</b>		
<b>V/f linear/square/parameterizable</b>	✓	✓
<b>V/f with flux current control (FCC)</b>	✓	✓
<b>Vector control, without encoder</b>	✓	✓
<b>Vector control, with encoder</b>	✓	✓
<b>Torque control, without encoder</b>	✓	✓
<b>Torque control, with encoder</b>	✓	✓

<sup>1)</sup> The current consumption of connected encoders and sensors (total, max. 300 mA) as well as the current drawn from the digital outputs must be added.

# SINAMICS G120D

## Distributed inverters 0.75 kW to 7.5 kW (1.0 hp to 10 hp)

### CU240D Control Units

#### Technical specifications

Control Unit	CU240D DP-F 6SL3544-0FA21-1PA0	CU240D PN-F 6SL3544-0FA21-1FA0
<b>Software functions</b>		
Fixed frequencies	16, parameterizable	16, parameterizable
Signal interconnection with BICO technology	✓	✓
Automatic restart after line supply failure or operational fault	✓	✓
Positioning down ramp	✓	✓
Slip compensation	✓	✓
Free function blocks (FFB) for logic and arithmetic operations	✓	✓
Ramp smoothing	✓	✓
3 selectable drive data sets	✓	✓
3 selectable command data sets (CDS) (manual/auto)	✓	✓
Flying restart	✓	✓
JOG	✓	✓
Technology controller (PID)	✓	✓
Thermal motor protection	✓	✓
Thermal inverter protection	✓	✓
Setpoint input	✓	✓
Motor identification	✓	✓
Motor holding brake	✓	✓
<b>Mechanical specifications and ambient conditions</b>		
Degree of protection	IP65	IP65
Operating temperature	0 ... 55 °C (32 ... 131 °F)	0 ... 50 °C (32 ... 122 °F)
Storage temperature	-40 ... +70 °C (-40 ... +158 °F)	-40 ... +70 °C (-40 ... +158 °F)
Relative humidity	< 95 % RH, condensation not permissible	< 95 % RH, condensation not permissible
<b>Dimensions</b>		
• Width	150 mm	150 mm
• Height	210 mm	210 mm
• Depth	40 mm	40 mm
Weight, approx.	0.7 kg	0.7 kg

# SINAMICS G120D

## Distributed inverters 0.75 kW to 7.5 kW (1.0 hp to 10 hp)

### Supplementary system components

#### Accessories

##### MMC memory card



The parameter settings for an inverter can be stored on the MMC memory card. When service is required, e.g. after the inverter has been replaced and the data have been downloaded from the memory card the drive system is immediately ready for use again.

##### Selection and ordering data

	Order No.
<b>MMC memory card</b>	<b>6SL3254-0AM00-0AA0</b>

##### RS232 interface cable for communication with a PC

For controlling and commissioning an inverter directly from a PC over a point-to-point link if the appropriate software (STARTER commissioning tool <sup>1)</sup>, from Version 4.1, SP1 and higher) has been installed.

##### Selection and ordering data

	Order No.
<b>RS232 interface cable</b> for communication with a PC	<b>3RK1922-2BP00</b>

##### USB interface cable for communication with a PC

For controlling and commissioning an inverter directly from a PC over a point-to-point link if the appropriate software (STARTER commissioning tool <sup>1)</sup>, from Version 4.1, SP1 and higher) has been installed.

##### Selection and ordering data

	Order No.
<b>USB interface cable</b> for communication with a PC (2.5 m long)	<b>new 6SL3555-0PA00-2AA0</b>

##### STARTER Commissioning Tool

The STARTER commissioning tool (from STARTER Version 4.1, SP1 and higher) supports the commissioning and maintenance of SINAMICSG 120D inverters. The operator guidance combined with comprehensive, user-friendly functions for the relevant drive solution allow you to commission the device quickly and easily.

##### Selection and ordering data

	Order No.
<b>STARTER commissioning tool <sup>1)</sup></b> on DVD	<b>6SL3072-0AA00-0AG0</b>

A Spare Parts Kit can be ordered which comprises small parts such as replacement seals, caps, PROFIBUS address windows and screws.

##### Selection and ordering data

	Order No.
<b>Spare Parts Kit for SINAMICS G120D</b> comprising replacement seals, caps, PROFIBUS address windows and screws	<b>6SL3500-0SK01-0AA0</b>

<sup>1)</sup> The STARTER commissioning tool is also available on the Internet under <http://support.automation.siemens.com/WW/view/en/10804985/133100>

## Overview

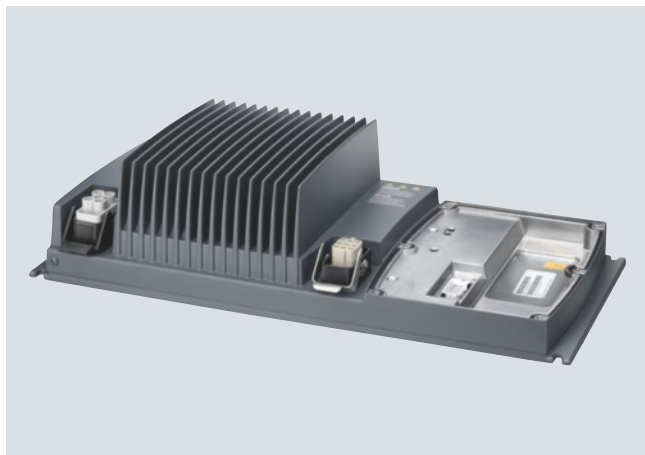

Example of PM250D Power Module frame size FSA

The regenerative feedback capability of the PM250D Power Module in generator mode (electronic braking) means that energy is returned to the supply system and is not wasted in a braking resistor. This saves space, time-consuming dimensioning of the braking resistor as well as its wiring. The amount of generated heat is also reduced. For further information, please refer to part Innovation, section Efficient Infeed Technology.

An innovative circuit design reduces the line harmonics. A line reactor is not required. This saves space and costs for configuration and procurement.

The PM250D Power Module is also designed for safety-oriented applications. In conjunction with a Fail-safe Control Unit, the drive can be turned into a Safety Integrated Drive (see Control Units).

The PM250D Power Modules with integrated class A line filter are suitable for connection to TN and TT supply systems.

## Selection and ordering data

Rated power <sup>1)</sup>		Rated output current <sup>2)</sup>	Input current	Frame size	SINAMICS G120D PM250D Power Module with integrated class A line filter Order No.
kW	hp	A	A		
<b>380 ... 500 V 3 AC</b>					
0.75	1	2.2	2.1	FSA	<b>6SL3525-0PE17-5AA0</b>
1.5	1.5 <sup>3)</sup>	4.1	3.8	FSA	<b>6SL3525-0PE21-5AA0</b>
3	4	7.7	7.2	FSB	<b>6SL3525-0PE23-0AA0</b>
4	5	10.2	9.5	FSC	<b>6SL3525-0PE24-0AA0</b>
5.5	7.5	13.2	12.2	FSC	<b>6SL3525-0PE25-5AA0</b>
7.5	10	19.0	17.7	FSC	<b>6SL3525-0PE27-5AA0</b>

## Integration

PM250D Power Modules communicate with the Control Unit via the PM-IF interface.

PM250D Power Modules have the following interfaces as standard:

- PM-IF interface to connect the PM250D Power Module to the Control Unit.
- Motor connection via a HAN Q8 (connector) including control of the motor brake and temperature sensor
- Line supply connection via HAN Q4/2 (socket)

<sup>1)</sup> Rated power based on the rated output current  $I_{rated}$ . The rated output current  $I_{rated}$  is based on the duty cycle for high overload (HO).

<sup>2)</sup> The rated output current  $I_{rated}$  is based on the duty cycle for high overload (HO). These current values are valid for 400 V and are stamped on the rating plate of the Power Module.

<sup>3)</sup> It is not possible to make any assignment to a particular standard.

# SINAMICS G120D

## Distributed inverters 0.75 kW to 7.5 kW (1.0 hp to 10 hp)

### PM250D Power Modules

#### Technical specifications

##### General technical specifications

	PM250D Power Modules												
<b>System operating voltage</b>	380 ... 500 V 3 AC $\pm 10\%$												
<b>Line supply requirements</b>	$\leq 1\%$												
<b>Line short circuit voltage <math>u_K</math></b>													
<b>Input frequency</b>	47 ... 63 Hz												
<b>Output frequency</b>													
• Control type V/f	0 ... 650 Hz												
• Control type Vector	0 ... 200 Hz												
<b>Pulse frequency</b>	4 kHz (standard), higher pulse frequencies up to 16 kHz, see the derating data												
<b>Power factor</b>	0.95												
<b>Inverter efficiency</b>	95 ... 97 %												
<b>Modulation depth</b>	87 %												
<b>Overload capability</b>													
• High overload (HO)	<ul style="list-style-type: none"> <li>• Average maximum rated output current during a cycle time of 300 s</li> <li>• <math>1.5 \times</math> rated output current (i.e. 150 % overload) over 60 s at a cycle time of 300 s</li> <li>• <math>2 \times</math> rated output current (i.e. 200 % overload) over 3 s at a cycle time of 300 s</li> </ul>												
<b>Electromagnetic compatibility</b>	Integrated class A line filter according to EN 55011												
<b>Possible braking methods</b>	Energy recovery in generator mode (max. with rated power possible); Integrated brake control supplies the DC supply voltage for the brake												
	<table border="1"> <thead> <tr> <th>Line voltage</th> <th>380 V AC</th> <th>400 V AC</th> <th>440 V AC</th> <th>480 V AC</th> <th>500 V AC</th> </tr> </thead> <tbody> <tr> <td>Rectified brake voltage</td> <td>171 V DC</td> <td>180 V DC</td> <td>198 V DC</td> <td>216 V DC</td> <td>225 V DC</td> </tr> </tbody> </table>	Line voltage	380 V AC	400 V AC	440 V AC	480 V AC	500 V AC	Rectified brake voltage	171 V DC	180 V DC	198 V DC	216 V DC	225 V DC
Line voltage	380 V AC	400 V AC	440 V AC	480 V AC	500 V AC								
Rectified brake voltage	171 V DC	180 V DC	198 V DC	216 V DC	225 V DC								
	Disconnection on the DC side permits "fast" braking (max. output current 1 A)												
<b>Degree of protection</b>	IP65												
<b>Operating temperature</b>	-10 ... +55 °C (operating temperature ranges of the Control Units should be taken into account)												
<b>Storage temperature</b>	-40 ... +70 °C (-40 ... +158 °F)												
<b>Permissible mounting position</b>	Horizontal wall mounting and mounting in the horizontal position												
<b>Relative humidity</b>	< 95 % RH, condensation not permissible												
<b>Cooling</b>	FSA and FSB: Convection FSC: Air cooling as required using the integrated fan												
<b>Installation altitude</b>	up to 1000 m above sea level without power reduction, > 1000 m see derating characteristics												
<b>Standard SCCR (Short Circuit Current Rating) <sup>1)</sup></b>	10 kA												
<b>Protection functions</b>	<ul style="list-style-type: none"> <li>• Undervoltage</li> <li>• Overvoltage</li> <li>• Overcontrol/overload</li> <li>• Ground fault</li> <li>• Short circuit</li> <li>• Stall protection</li> <li>• Motor blocking protection</li> <li>• Motor overtemperature</li> <li>• Inverter overtemperature</li> <li>• Parameter locking</li> </ul>												
<b>Standards conformance</b>	UL 508C (UL list number E121068), cUL, CE, c-tick												
<b>CE mark</b>	According to Low-Voltage Directive 73/23/EEC and Machinery Directive 98/37/EC												

<sup>1)</sup> Applies to industrial control cabinet installations to NEC Article 409/UL 508A. For further information, visit us on the Internet at: <http://support.automation.siemens.com/WW/view/en/23995621>

# SINAMICS G130

## Drive converter chassis units 75 kW to 800 kW

### SINAMICS G130 chassis units

#### Overview



SINAMICS G130 drive converter chassis units in frame sizes FX + HX

The SINAMICS G130 is a converter that can be combined very flexibly with the associated system components and integrated into customer-specific control cabinets or directly into machines.

The SINAMICS G130 drive converter chassis units are available for the following voltages and power ranges:

Line voltage	Power
380 ... 480 V 3 AC	110 ... 560 kW
500 ... 600 V 3 AC	110 ... 560 kW
660 ... 690 V 3 AC	75 ... 800 kW

A wide range of add-on electrical components allow the drive system to be optimized for specific requirements. Configuration and commissioning are greatly simplified by predefined interfaces.

The control accuracy of the sensorless vector control is suitable for most applications, and additional actual speed value encoders are therefore superfluous.

However, encoder evaluation units are available for the SINAMICS G130 converters so that they can address applications that require an encoder for plant-specific reasons.

Communication between the Control Unit, the Power Module and other active SINAMICS components takes place via DRIVE-CLiQ, the drive's internal interface. The DRIVE-CLiQ connections, which are available as pre-assembled cables of different lengths, allow a complete converter system to be put together quickly.

For communication with the process control system, with the CU320-2 either a PROFIBUS or a PROFINET interface is available as standard. There is also the option to expand the interface using digital and analog inputs and outputs. The TM31 Terminal Module and TB30 Terminal Board are provided for this purpose. Additional expansion cards can also be installed to allow communication via PROFINET and the CAN protocol.

# SINAMICS G130

## Drive converter chassis units 75 kW to 800 kW

### SINAMICS G130 chassis units

#### Benefits

- Particularly quiet and compact converters due to the use of state-of-the-art IGBT power semiconductors and an innovative cooling concept.
- Individual modules and power components can be replaced quickly and easily, which ensures a higher level of plant availability. The design of replaceable components is based on the principle that they must be quick and easy to change. In addition, the "SparesOnWeb" Internet tool makes it easy to view the spare parts that are available for the system components ordered.
- Can be easily integrated in automation solutions by means of a standard communications interface as well as a range of analog and digital interfaces.
- Easy commissioning and parameterization using interactive menus on the AOP30 Advanced Operator Panel with graphic LCD and plain-text display, or from a PC using the STARTER commissioning tool (→Tools and configuration).
- Preset software functions make it easier to tailor the converter to the individual plant.
- All components, from individual parts to the ready-to-connect cabinet, undergo rigorous testing throughout the entire production process. This guarantees a high level of functional reliability during installation and commissioning, as well as in operation.

#### Application

Variable-speed drives are ideal for all applications that involve moving, conveying, pumping or compressing solids, liquids or gases.

This means the following applications in particular:

- Pumps and fans
- Compressors
- Extruders and mixers
- Mills

#### Documentation

The documentation for the various drive units consists of the following parts:

- Operating instructions
- Spare parts list
- Unit-specific dimension drawings, layout diagrams, circuit and terminal diagrams

The documentation is supplied as standard with the CU Kit on CD-ROM. The documentation is available in English, French, German, Italian and Spanish.

#### Design

The SINAMICS G130 drive converter chassis unit provides machine builders and plant constructors with a modular drive system that can be tailored to specific applications.

SINAMICS G130 drive converter chassis units consist of two modular, stand-alone components:

- Power Module and
- Control Unit

They may be located separately from one another or combined in a single unit. The Power Module contains a slot for the Control Unit.

The Power Modules are supplied with a DRIVE-CLiQ cable for communication and a cable for the 24 V supply to the Control Unit. These cables are pre-assembled for installing the Control Unit in the Power Module. If the two units are installed in separate locations, the cables must be ordered in the appropriate lengths.

The AOP30 Advanced Operator Panel and the BOP20 Basic Operator Panel can be used for commissioning and local operation.

Predefined interfaces, via terminal block or the CU320-2 Control Unit with either PROFIBUS or PROFINET, make commissioning and control of the drive much easier. The interfaces of the CU320-2 Control Unit can be supplemented with add-on modules, such as the plug-in TB30 Terminal Module or the TM31 Terminal Module.

If further customer interfaces are needed to communicate with the drive, an external 24 V supply must be provided.

The two figures in the following pages are helpful when it comes to assembling the required converter components correctly. The first figure shows the design and individual components of a SINAMICS G130 drive. The second figure is a flowchart containing the decision and selection criteria required for the individual components.

#### Varnished PCBs

The following converter components are equipped as standard with varnished PCBs:

- Power Modules
- Control Units
- Sensor Modules
- Terminal Modules
- Advanced Operator Panel (AOP30)

The coating on the modules protects the sensitive SMD components against corrosive gases, chemically active dust and moisture.

#### Nickel-plated busbars

All of the copper busbars of the Power Modules are nickel-plated in order to achieve the best possible immunity to environmental effects. Further, the bare copper connections do not have to be cleaned for customer connections.

#### Additional information

Catalog D 11

Internet:

<http://www.siemens.com/sinamics>



**Design** (continued)

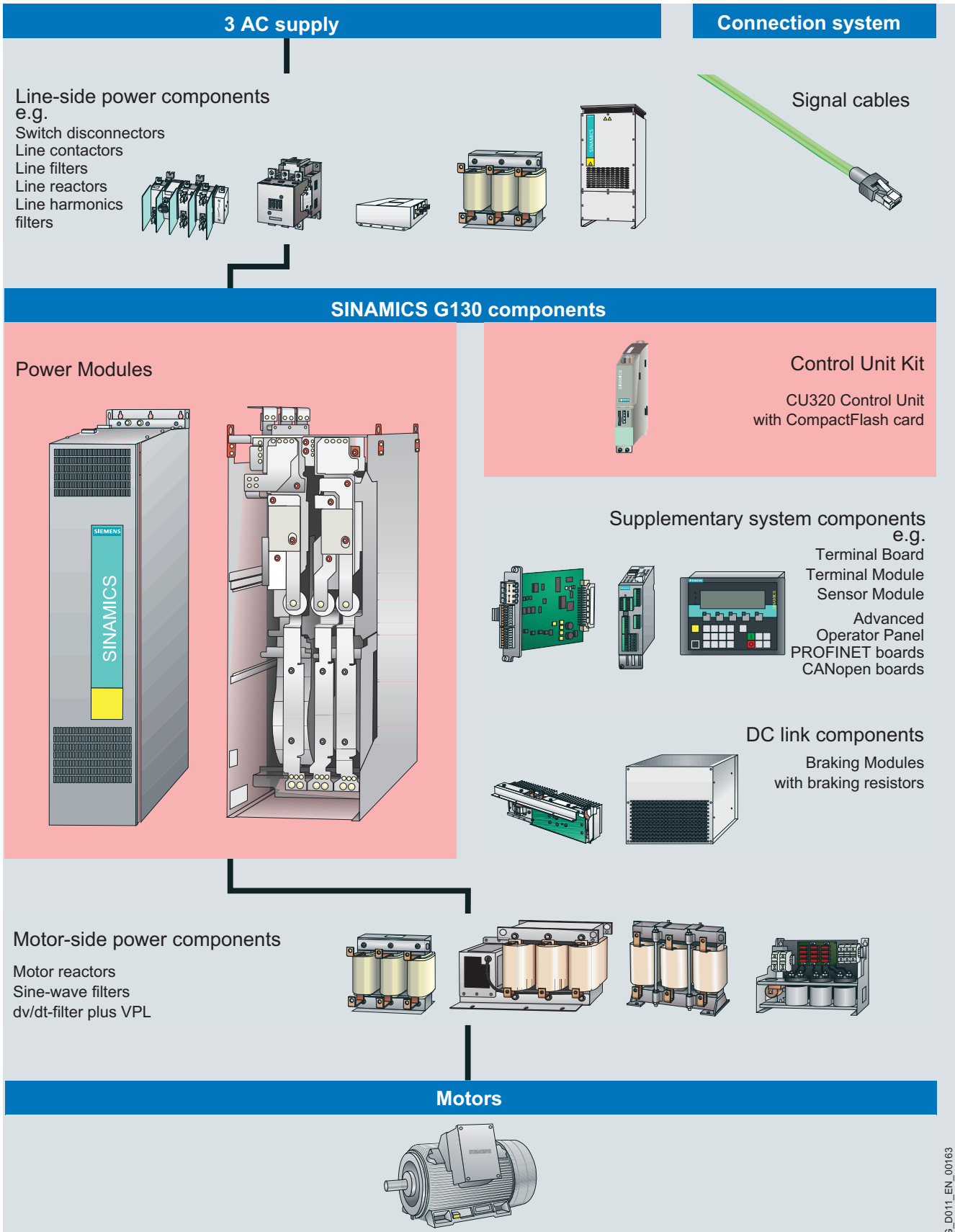

# SINAMICS G150

## Drive converter cabinet units 75 kW to 1500 kW

### SINAMICS G150 cabinet units

#### Overview



SINAMICS G150 drive converter cabinet units, versions A and C

With its SINAMICS G150 drive converter cabinet units, Siemens is offering a drive system on which all line-side and motor-side components as well as the Power Module are integrated extremely compactly into a specially designed cabinet enclosure. This approach minimizes the effort and expense required to configure and install them.

SINAMICS G150 has been specially tuned to the requirements of drives with quadratic and constant load characteristics, with medium performance requirements and without regenerative feedback.

The control accuracy of the sensorless Vector Control is suitable for most applications, and additional actual speed value encoders are therefore superfluous.

However, the SINAMICS G150 converters are optionally available with an encoder evaluator in order to handle applications that require an encoder for plant-specific reasons.

SINAMICS G150 drive converter cabinet units offer an economic drive solution that can be matched to customers' specific requirements by adding from the wide range of available components and options.

There are two versions of the drive converter cabinet units:

- **Version A**  
All available line connection components, such as the main switch, circuit-breakers, line contactor, line fuses, line filter, motor-side components, and additional monitoring devices, can be installed as required. This version is also available with power units connected in parallel.
- **Version C**  
This offers an extremely space-optimized structure without line-side components. This particularly slimline version can be used, for example, when line connection components are accommodated in a central low-voltage distribution panel (MCC) on the plantside.

The SINAMICS G150 drive converter cabinet units are available for the following voltages and power ranges:

Line voltage	Power range for single circuit (versions A and C)	Power range for parallel circuit (version A)
380 ... 480 V 3 AC	110 ... 560 kW	630 ... 900 kW
500 ... 600 V 3 AC	110 ... 560 kW	630 ... 1000 kW
660 ... 690 V 3 AC	75 ... 800 kW	1000 ... 1500 kW

Degrees of protection are IP20 (standard), and, as an option, IP21, IP23, IP43 and IP54.

#### Global use

SINAMICS G150 drive converter cabinet units are manufactured in compliance with relevant international standards and regulations, and are therefore suitable for global use (→ Technical specifications).

# SINAMICS G150

## Drive converter cabinet units 75 kW to 1500 kW

### SINAMICS G150 cabinet units

#### Benefits

- Particularly quiet and compact converters due to the use of state-of-the-art IGBT power semiconductors and an innovative cooling concept.
- Individual modules and power components can be replaced quickly and easily, which ensures a higher level of plant availability. The design of replaceable components is based on the principle that they must be quick and easy to change. In addition, the "SparesOnWeb" Internet tool makes it easy to view the spare parts that are available for the system components ordered.
- Can be easily integrated in automation solutions due to a communications interface supplied as standard and various analog and digital interfaces.
- Easy commissioning and parameterization using interactive menus on the user-friendly AOP30 Advanced Operator Panel with graphical LCD and plain-text display, or from a PC using the STARTER commissioning tool (→ Tools and configuration)
- Preset software functions make it easier to tailor the converter to the individual plant. For example, the key functions for controlling pumps are stored as a preprogrammed macro in the drive.
- They have been designed as "zoned" units and therefore offer the highest possible standard of operational reliability. EMC measures have been rigorously implemented. With the help of simulated conditions, partitions have been designed to act as air guides and heat dissipation units.
- Special measures used in the construction of the cabinets ensure that they remain mechanically durable throughout their entire life cycle. All components, from individual parts to the ready-to-connect cabinet, undergo rigorous testing throughout the entire production process. This guarantees a high level of functional reliability during installation and commissioning, as well as in operation.

#### Application

Variable-speed drives are advantageous for all applications that involve moving, conveying, pumping or compressing solids, liquids or gases.

This means the following applications in particular:

- Pumps and fans
- Compressors
- Extruders and mixers
- Mills

#### Design

SINAMICS G150 drive converter cabinet units are characterized by their compact, modular, and service-friendly design.

A wide range of options is available depending on the cabinet version which permit optimum adaptation of the drive system to the respective requirements (→ Options).

#### Additional information

Catalog D 11

Internet:

<http://www.siemens.com/sinamics>

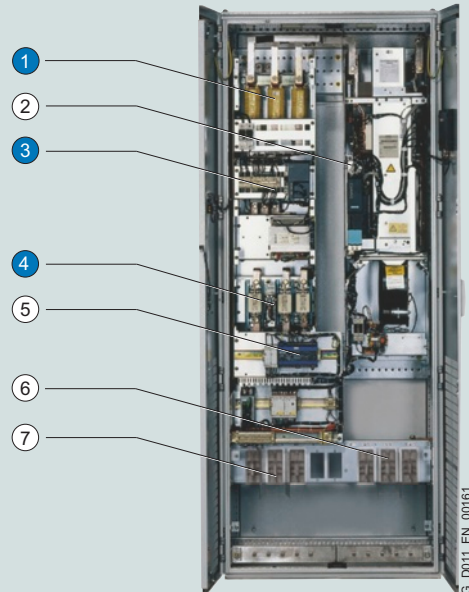

- ① Line reactor (< 500 kW standard)
  - ② PROFIBUS connection
  - ③ Line contactor
  - ④ Main control switch with fuses
  - ⑤ Customer's terminal block
  - ⑥ Motor connection
  - ⑦ Line connection
- Standard version  
● Options

Example of design of a SINAMICS G150 drive converter cabinet unit, version A

# SINAMICS S110

## Single-axis drives 0.12 kW to 90 kW

The basic positioning drive  
for single-axis applications

### Overview

*SINAMICS S110 – the basic positioning drive for single-axis applications*

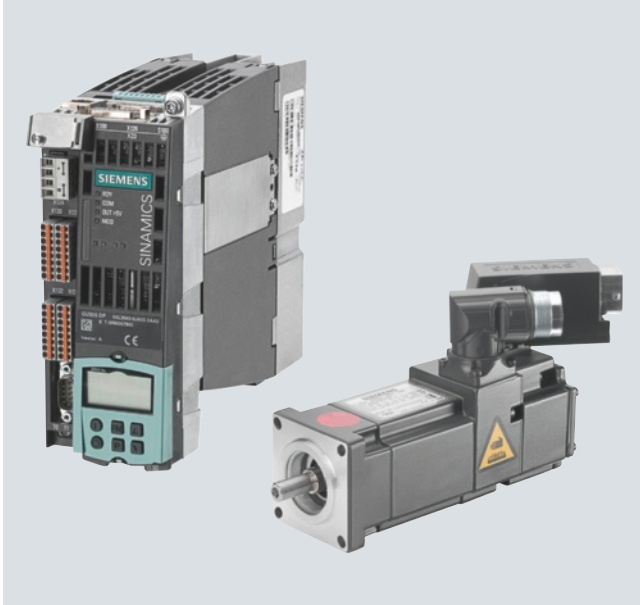

Many applications in mechanical engineering and plant construction require machine axes to be positioned quickly and precisely by the simplest possible method. It is often simply a case of moving a machine axis from position X to position Y reliably and with the required level of performance. The SINAMICS S110 drive converter is ideally suited to this type of application. It is specially designed to position single axes accurately and effectively.

SINAMICS S110 is the perfect solution for many applications. Typical examples are:

- Handling equipment
- Feed and withdrawal devices
- Stacking units
- Automatic assembly machines
- Laboratory automation
- Metalworking
- Machines used in the wood, glass and ceramic industries
- Printing machines
- Plastics processing machines

The so-called basic positioner (EPOs) is an integral component of the SINAMICS S110. It provides a simple method of solving positioning tasks.

The SINAMICS S110 is designed for connection to both synchronous servo motors and asynchronous (induction) motors. It supports all the most popular types of encoder.

A variety of field bus interfaces is provided for linking the unit to a higher-level control system. Alternatively, it can be controlled via a  $\pm 10$  V setpoint interface.

An outstanding feature of the SINAMICS S110 converter is its integrated safety functions (Safety Integrated) which make it easy to provide highly effective protection for personnel and machinery.

### Flexible in application

SINAMICS S110 is a flexible, versatile system.

Synchronous servo motors and asynchronous (induction) motors with outputs up to 90 kW can be used to implement rotary or linear axes.

When DRIVE-CLiQ motors are used they can be connected simply by means of the integrated DRIVE-CLiQ interface. This means that the electronic rating plate of the motor can be easily read out, reducing the engineering time and overhead involved in commissioning the drive.

Furthermore, the SINAMICS S110 features an integrated encoder interface for optional use. It is capable of evaluating HTL and TTL encoders.

In addition to pure point-to-point positioning, SINAMICS S110 naturally offers also on-the-fly changeover from continuous operation to positioning mode in order, for example, to precisely position objects transported randomly on a conveyor belt. Even simple traversing profiles with different motion cycles and wait times can be executed automatically by SINAMICS S110.

The Control Unit of the SINAMICS S110 (CU305) is equipped with an integrated communication interface for linking the converter to an automation system. A CANopen or PROFIBUS interface can be ordered. Standardized protocols for linking to a higher-level control are supported – the PROFIdrive profile for positioning mode and the PROFIsafe profile for safety-related communication.

The converter is thus perfectly coordinated with the SIMATIC S7 automation system. The devices are linked by means of PROFIBUS and the SIMATIC S7 uses standard function blocks to communicate with the drive. In addition, the STARTER commissioning tool can be seamlessly integrated into STEP7, the SIMATIC's programming software.

### BICO technology

Every drive contains a number of input and output variables which can be freely and independently interconnected using Binector Connector Technology (BICO). A binector is a logic signal which can assume the value 0 or 1. A connector is a numerical value, e.g. the actual speed or current setpoint.

### Free function blocks

The "free function blocks" integrated in the CU305 Control Unit can be adapted easily but precisely to a very broad range of customized requirements. The available range of blocks includes simple logic blocks such as AND/OR elements, as well as more complex devices such as ramp-function generators, smoothing elements or limit-value monitors. All blocks can be flexibly interconnected using BICO (Binector-Connector) technology, ensuring that signals are processed quickly and internal to the drive which helps to reduce the load on the higher-level control.

### Diagnostics optimally supported by trace function

The time characteristics of input and output variables associated with drives can be measured by the integrated trace function and displayed using the STARTER commissioning tool. The trace can record up to 4 signals simultaneously. The recording can be triggered as a function of freely selectable boundary conditions, e.g. the value of an input or output variable.

# SINAMICS S110

## Single-axis drives 0.12 kW to 90 kW

The basic positioning drive  
for single-axis applications

### Functions

The EPos basic positioner in the SINAMICS S110 drive system provides powerful and precise positioning functions. Due to its flexibility and adaptability, the basic positioner can be used for a wide range of positioning tasks.

The functions are easy to handle both during commissioning and during operation, and the comprehensive monitoring functions are outstanding.

Many applications can be carried out without external position controllers.

The EPos basic positioner is used to position linear and rotary axes (modulo) in absolute/relative terms with rotary as well as linear motor encoder or machine encoder (indirect measuring system).

EPos is a function module that can be activated on synchronous and asynchronous (induction) motors.

User-friendly configuring and commissioning including control panel (operation using PC) and diagnostics with the STARTER commissioning tool.

In addition to extremely flexible positioning functions, EPos offers a high degree of user-friendliness and reliability thanks to integral monitoring and compensation functions.

Different operating modes and their functionality increase flexibility and plant productivity, for example, by means of "on-the-fly" and bumpless correction of the motion control.

Preconfigured PROFIdrive positioning frames are available which, when selected, automatically establish the internal "connection" to the basic positioner.

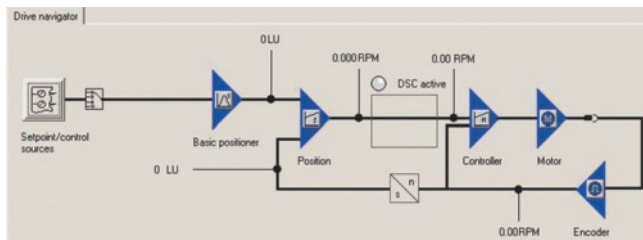

Position controller

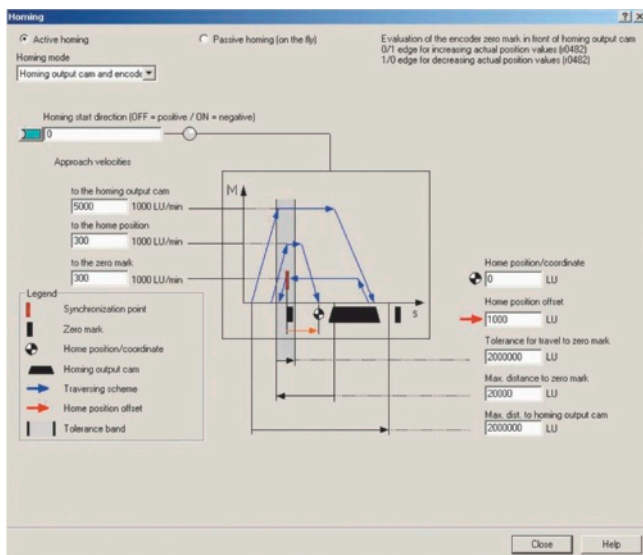

Going to home position

### Functionality of the EPos basic positioner

#### Closed-loop position control with the following essential components

- Position actual value sensing (including the lower-level measuring probe evaluation and reference mark search)
- Position controller (including limits, adaptation and pre-control calculation)
- Monitoring functions (standstill, positioning and dynamic following error monitoring, cam signals)

#### Mechanical system

- Backlash compensation
- Modulo offset

#### Limits

- Speed/acceleration/delay/jerk limitation
- Software limit switch (traversing range limitation by means of position setpoint evaluation)
- Stop cams (traversing range limitation by means of hardware limit switch evaluation)

#### Homing and alignment

- Set reference point (for an axis at standstill)
- Search for reference (separate mode including reversing cam functionality, automatic reversal of direction, homing to "output cam and encoder zero mark" or only "encoder zero mark" or "external zero mark (proximity switches)")
- Flying referencing (seamless homing possible during "normal" traversing with the aid of the measuring input evaluation; generally evaluation, e.g. of a proximity sensor. Subordinate function for the modes "jog", "direct setpoint input/MDI" and "traversing blocks")
- Absolute encoder alignment

#### Traversing blocks mode (16 traversing blocks)

- Positioning using traversing blocks that can be stored in the drive unit including block change enable conditions and specific tasks for an axis that was previously referenced
- Traversing block editor using STARTER
- A traversing block contains the following information:
  - Job number and job (e.g. positioning, waiting, GOTO set jump, setting of binary outputs, travel to fixed stop)
  - Motion parameters (target position, override speed for acceleration and deceleration)
  - Mode (e.g.: hide block, continuation conditions such as "Continue\_with\_stop", "Continue\_flying" and "Continue\_externally using high-speed probe inputs")
  - Job parameters (e.g. waiting time, block step conditions)

#### Direct setpoint input (MDI) mode

- Positioning (absolute, relative) and setting-up (endless closed-loop position control) using direct setpoint inputs (e.g. via the PLC using process data)
- It is always possible to influence the motion parameters during traversing (on-the-fly setpoint acceptance) as well as on-the-fly change between the setup and positioning modes
- The direct setpoint specification operating mode (MDI) can also be used in positioning or setup mode if the axis is not homed. This means that on-the-fly synchronization and re-homing can be carried out with "flying referencing".

#### Jog mode

- Closed-loop position controlled traversing of the axis with the "endless position controlled" or "jog incremental" modes, which can be toggled between (traverse through a "step width")

# SINAMICS S110

## Single-axis drives 0.12 kW to 90 kW

### CU305 Control Unit

#### Overview



CU305 Control Unit with BOP20

The CU305 Control Unit for the communication and open-loop/closed-loop control functions of a SINAMICS S110 is combined with the PM340 Power Module to create a powerful single drive.

#### Integration

The CU305 controls the PM340 via the PM-IF interface.

A BOP20 Basic Operator Panel can also be snapped directly onto the CU305 for parameterization and diagnostic purposes.

DRIVE-CLiQ motors or Sensor Modules (SMC10 or SMC20) can also be connected to the integrated DRIVE-CLiQ socket to permit the operation of motors without a DRIVE-CLiQ interface.

The status of the CU305 is indicated via multi-color LEDs.

The CU305 can be operated optionally with a memory card. The firmware and project data are stored on the plug-in card underneath, so that the CU305 can be replaced without the support of software tools. This memory card can also be used to perform standard commissioning on multiple drives of identical type. The card is available as an empty memory card or containing the latest drive firmware version. The safety license for the extended safety functions can be added to the MMC memory card. To use these extended safety functions, a memory card containing the safety license must be permanently inserted.

The CU305 and other connected components are commissioned and diagnosed with the STARTER commissioning tool.

#### Design

The CU305 features the following connections and interfaces as standard:

- 1 DRIVE-CLiQ socket, used solely to connect a DRIVE-CLiQ motor or a Sensor Module
- 1 PM-IF interface for communication with PM340 Power Modules in Blocksize format
- 1 interface to the BOP20 Basic Operator Panel
- 1 field bus communication interface via order selection:
  - PROFIBUS interface with PROFIdrive V4 profile (CU305 DP)
  - CAN open interface (CU305 CAN)
  - PROFINET interface with 2 ports and PROFIdrive V4 profile (CU305 PN available soon)
- 1 onboard encoder evaluation
  - The following encoder signals can be evaluated:
    - Incremental encoder TTL/HTL
    - SSI encoder without incremental signals (available soon)
- 1 analog input:  $\pm 10$  V, 13-bit resolution
- 3 parameterizable, fail-safe digital inputs (floating) or alternatively: 6 parameterizable digital inputs (floating)
- 1 parameterizable, fail-safe digital output (floating) or alternatively: 1 digital output (floating)
- 4 parameterizable bidirectional digital inputs/outputs (floating)
- 5 parameterizable digital inputs (floating)
- 1 serial RS232 interface
- 1 slot for a memory card on which the firmware, parameters and licenses can be stored
- 2 test sockets and one reference ground for commissioning support
- 1 x connection for the electronics power supply via the 24-V-DC power supply connector
- 1 PE/protective conductor connection
- 1 temperature sensor input (KTY84-130 or PTC)

#### Integration

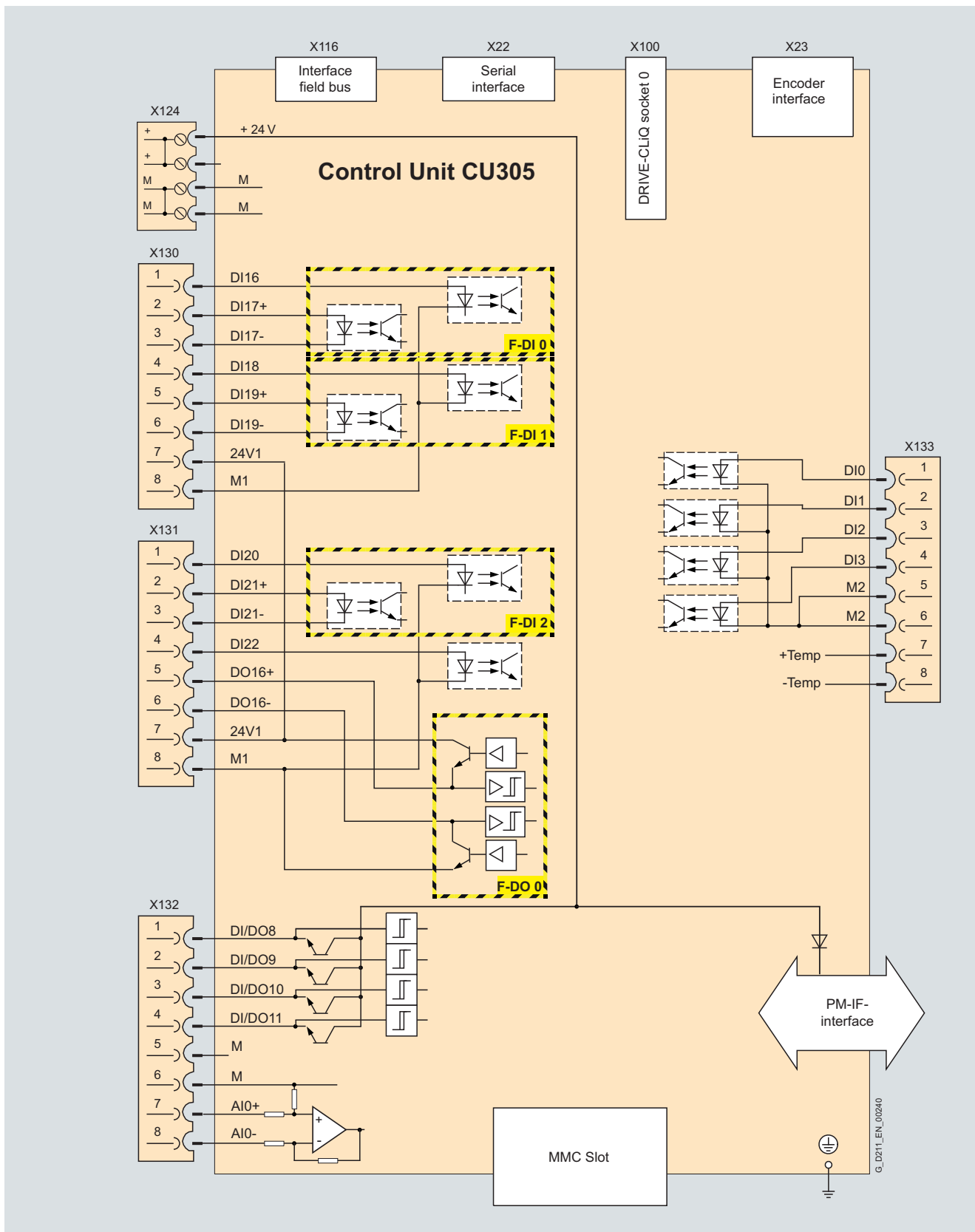

4

Terminal assignments on CU305 (DP or CAN)

# SINAMICS S110

## Single-axis drives 0.12 kW to 90 kW

### CU305 Control Unit

#### Technical specifications

	CU305 DP and CU305 CAN Control Units
<b>Current demand</b> at 24 V DC, max. without taking account of digital outputs and DRIVE-CLiQ supply	0.8 A for CU305 incl. 350 mA for HTL encoder + 0.5 A for PM340 Power Module
<b>Max. conductor cross-section</b>	2.5 mm <sup>2</sup>
<b>Fuse protection, max.</b>	20 A
<b>Digital inputs</b>	In accordance with IEC 61131-2 Type 1 3 floating fail-safe inputs 5 bidirectional floating digital inputs/outputs • -3 ... +30 V • -3 ... +5 V • 15 ... 30 V • 6 mA  15 µs 55 µs  5 µs 5 µs • 1.5 mm <sup>2</sup>
<ul style="list-style-type: none"> <li>• Voltage</li> <li>• Low level (an open digital input is interpreted as "low")</li> <li>• High level</li> <li>• Current consumption at 24 V DC, typ.</li> <li>• Delay time of digital inputs <sup>1)</sup>, approx. <ul style="list-style-type: none"> <li>- L → H</li> <li>- H → L</li> </ul> </li> <li>• Delay time of high-speed digital inputs <sup>1)</sup>, approx. (high-speed digital inputs can be used for position detection) <ul style="list-style-type: none"> <li>• L → H</li> <li>• H → L</li> </ul> </li> <li>• Max. conductor cross-section</li> </ul>	
<b>Digital outputs</b> (continuously short-circuit-proof)	1 fail-safe digital output 4 bidirectional non-floating digital inputs/digital outputs • 24 V DC • 100 mA  • 150 µs • 1.5 mm <sup>2</sup>
<ul style="list-style-type: none"> <li>• Voltage</li> <li>• Load current per digital output <sup>2)</sup>, max.</li> <li>• Delay time <sup>1)</sup>, approx.</li> <li>• Max. conductor cross-section</li> </ul>	
<b>Analog input</b>	-10 ... +10 V • 15 kΩ
<b>Encoder evaluation</b>	<ul style="list-style-type: none"> <li>• Incremental encoder TTL/HTL</li> <li>• SSI encoder without incremental signals (available soon)</li> <li>• 24 V DC/0.35 A or 5 V DC/0.35 A</li> <li>• 500 kHz</li> <li>• 100 ... 250 kbaud depending on cable length</li> <li>• 30 bit</li> </ul> 100 m (328 ft) (only bipolar signals permitted <sup>3)</sup> ) - HTL encoder 100 m (328 ft) for unipolar signals 300 m (984 ft) for bipolar signals <sup>3)</sup> - SSI encoder 100 m (328 ft)
<b>Power loss</b>	< 20 W
<b>PE connection</b>	M5 screw
<b>Dimensions</b>	<ul style="list-style-type: none"> <li>• Width</li> <li>• Height</li> <li>• Depth</li> </ul>
<ul style="list-style-type: none"> <li>• 73 mm (2.87 in)</li> <li>• 183.2 mm (7.21 in)</li> <li>• 89.6 mm (3.53 in)</li> </ul>	
<b>Weight, approx.</b>	0.95 kg (2.09 lbs)
<b>Approvals</b>	cULus (File No.: E164110)

<sup>1)</sup> The specified delay times refer to the hardware. The actual reaction time depends on the time slice in which the digital input or output is processed.

#### Selection and ordering data

	Order No.
<b>CU305 DP Control Unit</b> (without memory card)	<b>6SL3040-0JA00-0AA0</b>
<b>CU305 CAN Control Unit</b> (without memory card)	<b>6SL3040-0JA02-0AA0</b>

#### Accessories

	Order No.
<b>MMC memory card for CU305 DP and CU305 CAN Control Units</b>	
• empty	<b>6SL3054-4AG00-0AA0</b>
• with firmware version V4.1	<b>6SL3054-4EB00-0AA0</b>
• with firmware version V4.1 and safety license (extended functions)	<b>6SL3054-4EB00-0AA0-Z F01</b>
<b>Safety license (extended functions)</b> for a supplementary/separate order	<b>6SL3074-0AA10-0AA0</b>
<b>PROFIBUS connectors</b>	
• without programming device/PC connection	<b>6ES7972-0BA41-0XA0</b>
• with programming device/PC connection	<b>6ES7972-0BB41-0XA0</b>
<b>STARTER commissioning tool</b>	<b>6SL3072-0AA00-0AG0</b>

<sup>2)</sup> In order to use the digital outputs, an external 24 V power supply must be connected to terminal X124.

<sup>3)</sup> Signal cables twisted in pairs and shielded.



# SINAMICS S110

## Single-axis drives 0.12 kW to 90 kW

PM340 Power Modules Blocksize format

### Overview



PM340 Power Modules Blocksize format, frame sizes FSA to FSF

The PM340 Power Modules in Blocksize format feature the following connections and interfaces as standard:

- Line connection
- PM-IF interface for connection of the PM340 and CU305 Control Unit. The PM340 also supplies power to the CU305 by means of an integrated power supply
- Terminals DCP/R1 and R2 for connection of an external braking resistor
- Motor connection made with screw terminals or screw studs
- Control circuit for the Safe Brake Relay for controlling a holding brake
- 2 PE/protective conductor connections

PM340 modules without integrated line filter are designed for connection to grounded (TN, TT) and non-grounded (IT) systems.

PM340 modules with integrated line filter are suitable for connection to TN systems only.

When utilizing the integrated Braking Module (Braking Chopper), the temperature of the external braking resistor must be monitored (i.e. thermostatic switch) to provide protection against thermal overloading.

### Integration

The PM340 modules communicate with the CU305 via the PM-IF interface.



PM340 with CU305 DP and BOP20

# SINAMICS S110

## Single-axis drives 0.12 kW to 90 kW

### PM340 Power Modules Blocksize format

#### Integration

4

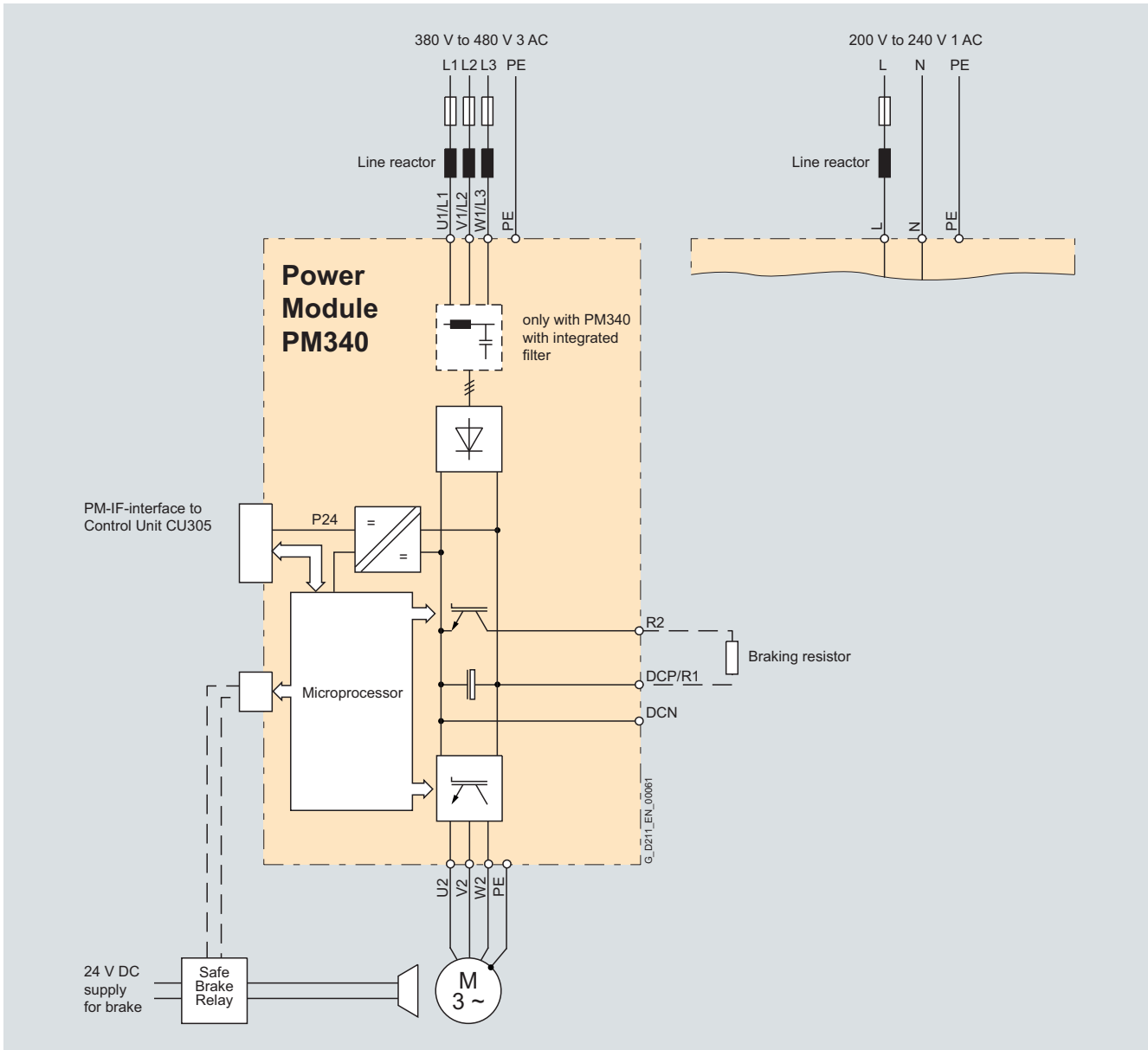

PM340 connection example

# SINAMICS S110

## Single-axis drives 0.12 kW to 90 kW

### PM340 Power Modules Blocksize format

#### Integration

Many system components for PM340 Power Modules are designed as base components, i.e. the component is mounted on the baseplate and the PM340 in front of them in a space-saving construction. Up to two base components can be mounted one after another.

	FSA	FSB	FSC	FSD	FSE	FSF
Line filter	✓	-	-	-	-	-
Line reactor	✓	✓	✓	✓	✓	○
Braking resistor	✓	✓	○	○	○	○
Motor reactor	✓	✓	✓	○	○	○

✓ = suitable as base type  
 ○ = not suitable as base type  
 - = not available (use PM340 with integrated line filter)

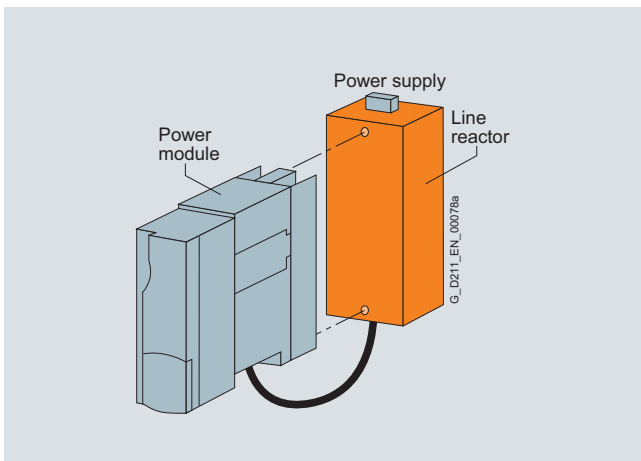

Basic layout of a PM340 with line reactor as base component

The line-side reactors are equipped with terminals and the reactors at the PM340 end with a pre-assembled cable. When installed, the mains terminals are at the top on frame sizes FSA to FSC, and at the bottom on frame sizes FSD and FSE.

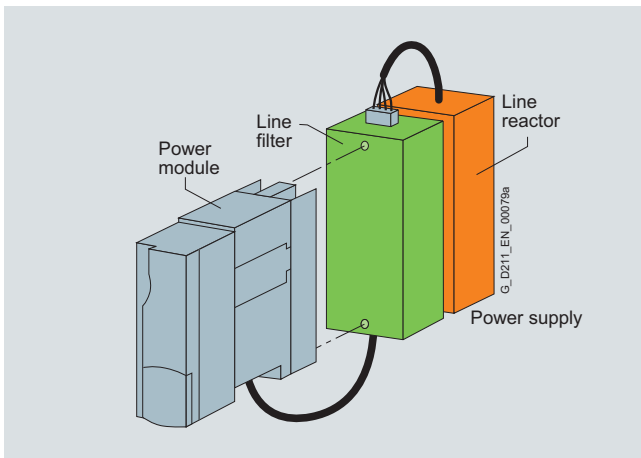

PM340 in frame size FSA with line reactor and line filter

If a line filter is installed in addition to the line reactor on frame size FSA, the components must be arranged as shown in the figure above. In this case, the line connection is below.

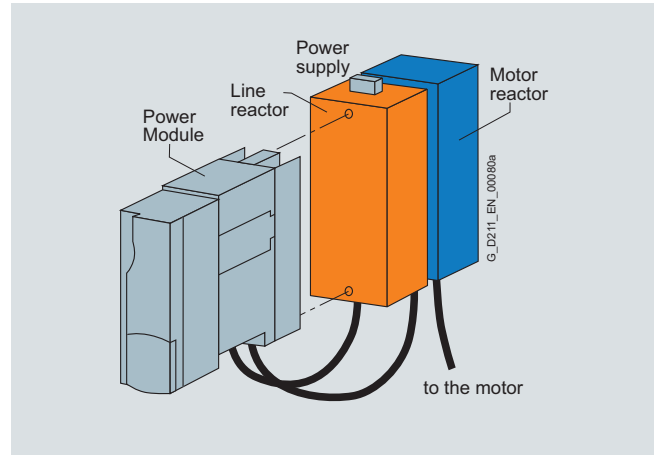

PM340 in frame size FSA with line reactor and motor reactor

PM340 modules of frame size FSB and higher are available with integrated line filters, alleviating the need for an external line filter.

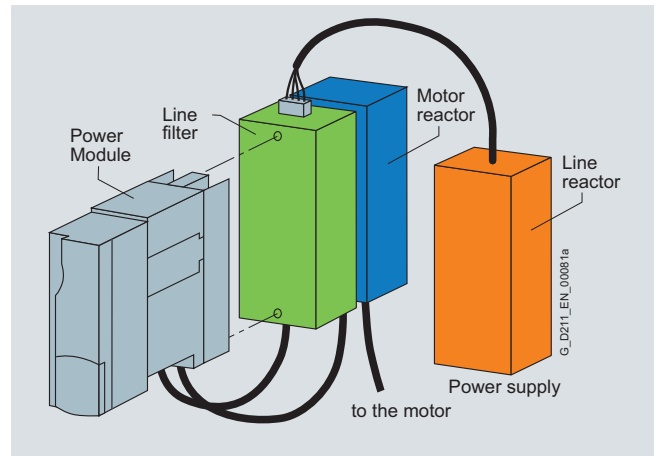

For configurations involving more than two base-type system components, e.g. line reactor + motor reactor + braking resistor, individual components must be mounted to the side of the PM340. In this instance, the line and motor reactors must be installed behind the PM340 and the braking resistor to the side.

# SINAMICS S110

## Single-axis drives 0.12 kW to 90 kW

### PM340 Power Modules Blocksize format

#### Technical specifications

##### General technical specifications

##### Electrical data

<b>Line voltage</b> (up to 2000 m (6562 ft) above sea level)	200 V ... 240 V 1 AC $\pm 10\%$ (-15 % < 1 min) or 380 ... 480 V 3 AC $\pm 10\%$ (-15 % < 1 min)
<b>Line frequency</b>	47 ... 63 Hz
<b>Line power factor</b> with rated power	
• Fundamental mode ( $\cos \varphi_1$ )	> 0.96
• Total ( $\lambda$ )	
- 200 ... 240 V 1 AC	0.45 ... 0.7
- 380 ... 480 V 3 AC	0.65 ... 0.95
<b>Overvoltage category</b> acc. to EN 60664-1	Class III
<b>Precharging frequency</b> of the DC link, max.	1× every 30 s
<b>DC link voltage, approx.</b>	1.35 × line voltage
<b>Output frequency</b>	
• Control type Servo	0 ... 650 Hz
<b>Electronics power supply</b>	24 V DC -15 %/+20 %
<b>Radio interference suppression</b>	
• Standard	No interference suppression
• With integrated line filter	Category C2 according to EN 61800-3
<b>Environmental requirements</b>	
<b>Cooling method</b>	Forced air cooling by means of built-in fan
<b>Permissible ambient or coolant temperature (air)</b> in operation for line-side components, Power Modules	0 ... 40 °C (32 ... 104 °F) without derating, > 40 ... 55 °C (104 ... 131 °F), see derating characteristics
<b>Installation altitude</b>	Up to 1000 m (3281 ft) above sea level without derating, > 1000 ... 4000 m (3281 ... 13124 ft) above sea level, see derating characteristics
<b>Conformity</b>	CE (low-voltage and EMC Directives)
<b>Approvals</b>	cULus
• 200 ... 240 V 1 AC	
- Frame size FSA	File No. E192450
• 380 ... 480 V 3 AC	
- Frame size FSA ... FSC	File No. E121068
- Frame sizes FSD ... FSF	File No. E192450
<b>Safety Integrated</b>	Safety Integrity Level 2 (SIL 2) according to IEC 61508, control category 3 according to EN 954-1 (for further information, see section headed "Safety Integrated")

# SINAMICS S110

## Single-axis drives 0.12 kW to 90 kW

**PM340 Power Modules Blocksize format**
**Selection and ordering data**

Rated output current	Type rating	Frame size	PM340 Power Module in Blocksize format <u>w/o</u> line filter	PM340 Power Module in Blocksize format <u>w/</u> integrated line filter
A	kW (HP)		Order No.	Order No.
<b>Line voltage 200 ... 240 V 1 AC</b>				
0.9	0.12 (0.2)	FSA	<b>6SL3210-1SB11-0UA0</b>	<b>6SL3210-1SB11-0AA0</b>
2.3	0.37 (0.5)	FSA	<b>6SL3210-1SB12-3UA0</b>	<b>6SL3210-1SB12-3AA0</b>
3.9	0.75 (1)	FSA	<b>6SL3210-1SB14-0UA0</b>	<b>6SL3210-1SB14-0AA0</b>
<b>Line voltage 380 ... 480 V 3 AC</b>				
1.3	0.37 (0.5)	FSA	<b>6SL3210-1SE11-3UA0</b>	–
1.7	0.55 (0.75)	FSA	<b>6SL3210-1SE11-7UA0</b>	–
2.2	0.75 (1)	FSA	<b>6SL3210-1SE12-2UA0</b>	–
3.1	1.1 (1.5)	FSA	<b>6SL3210-1SE13-1UA0</b>	–
4.1	1.5 (2)	FSA	<b>6SL3210-1SE14-1UA0</b>	–
5.9	2.2 (3)	FSB	<b>6SL3210-1SE16-0UA0</b>	<b>6SL3210-1SE16-0AA0</b>
7.7	3 (5)	FSB	<b>6SL3210-1SE17-7UA0</b>	<b>6SL3210-1SE17-7AA0</b>
10.2	4 (5)	FSB	<b>6SL3210-1SE21-0UA0</b>	<b>6SL3210-1SE21-0AA0</b>
18	7.5 (10)	FSC	<b>6SL3210-1SE21-8UA0</b>	<b>6SL3210-1SE21-8AA0</b>
25	11 (15)	FSC	<b>6SL3210-1SE22-5UA0</b>	<b>6SL3210-1SE22-5AA0</b>
32	15 (20)	FSC	<b>6SL3210-1SE23-2UA0</b>	<b>6SL3210-1SE23-2AA0</b>
38	18.5 (25)	FSD	<b>6SL3210-1SE23-8UA0</b>	<b>6SL3210-1SE23-8AA0</b>
45	22 (30)	FSD	<b>6SL3210-1SE24-5UA0</b>	<b>6SL3210-1SE24-5AA0</b>
60	30 (40)	FSD	<b>6SL3210-1SE26-0UA0</b>	<b>6SL3210-1SE26-0AA0</b>
75	37 (50)	FSE	<b>6SL3210-1SE27-5UA0</b>	<b>6SL3210-1SE27-5AA0</b>
90	45 (60)	FSE	<b>6SL3210-1SE31-0UA0</b>	<b>6SL3210-1SE31-0AA0</b>
110	55 (75)	FSF	<b>6SL3210-1SE31-1UA0</b>	<b>6SL3210-1SE31-1AA0</b>
145	75 (100)	FSF	<b>6SL3210-1SE31-5UA0</b>	<b>6SL3210-1SE31-5AA0</b>
178	90 (125)	FSF	<b>6SL3210-1SE31-8UA0</b>	<b>6SL3210-1SE31-8AA0</b>

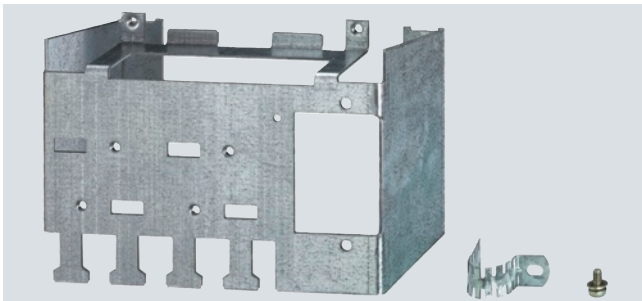
**Accessories**

Example of shield connection kit for PM340 frame size FSB

Order No.
<b>Shield connection kit</b> for PM340
• Frame size FSA
• Frame size FSB
• Frame size FSC
• Frame sizes FSD and FSE
• Frame size FSF
<b>6SL3262-1AA00-0BA0</b>
<b>6SL3262-1AB00-0DA0</b>
<b>6SL3262-1AC00-0DA0</b>
<b>6SL3262-1AD00-0DA0</b>
<b>6SL3262-1AF00-0DA0</b>

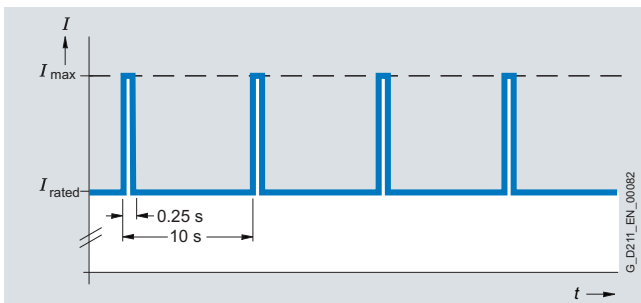
**Characteristic curves**
*Overload capability*

Duty cycle with initial load

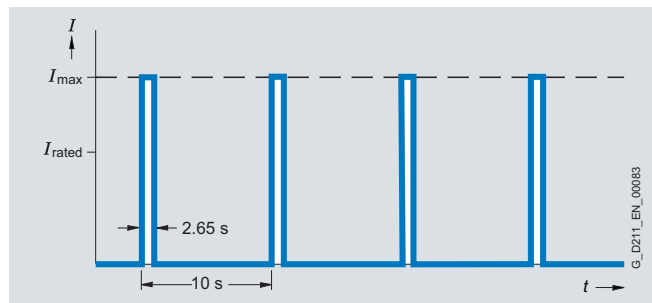

Duty cycle without initial load

# SINAMICS S110

## Single-axis drives 0.12 kW to 90 kW

### PM340 Power Modules Blocksize format

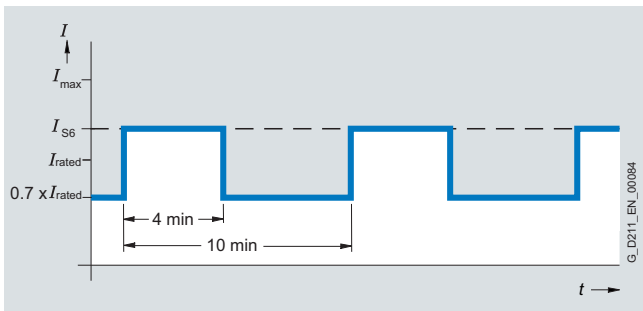

S6 duty cycle with initial load with a duty cycle duration of 600 s

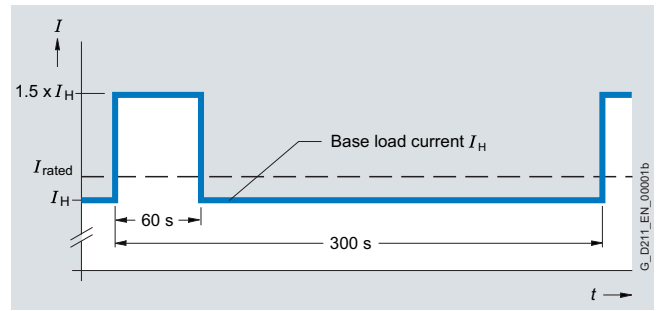

Load cycle with 60 s overload with a load cycle period of 300 s

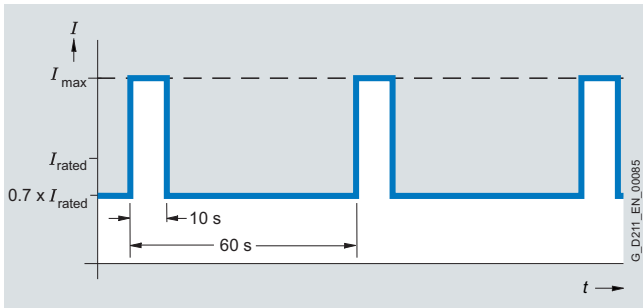

S6 duty cycle with initial load with a duty cycle duration of 60 s

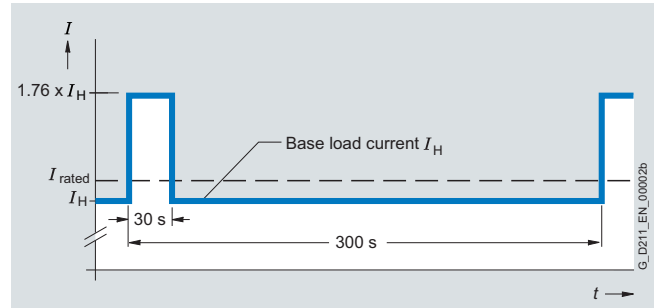

Load cycle with 30 s overload with a load cycle period of 300 s

#### Derating characteristics

- Frame sizes FSA to FSE

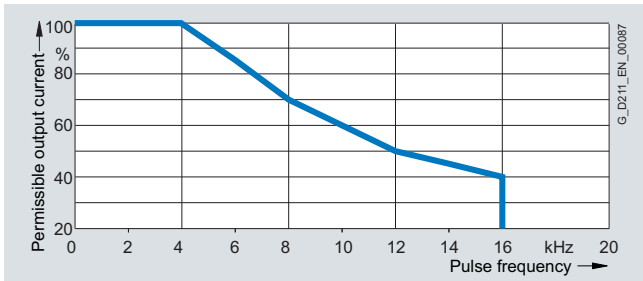

Output current as a function of pulse frequency

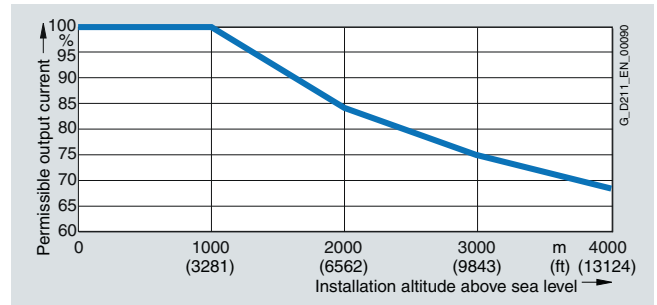

Output current as a function of installation altitude

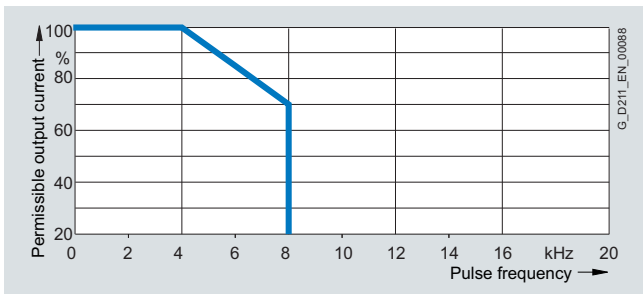

Output current as a function of pulse frequency

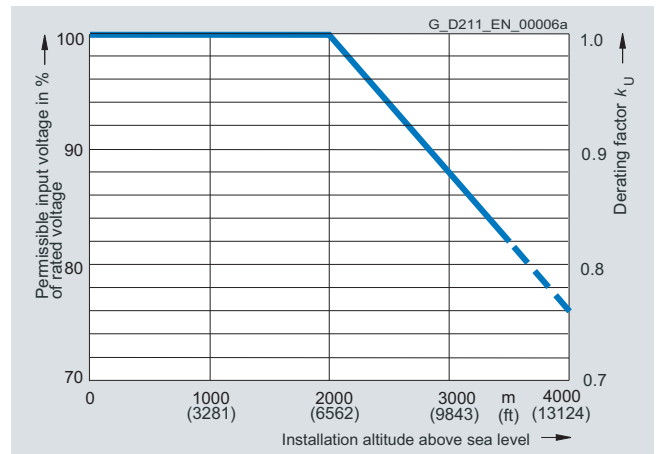

Voltage derating as a function of installation altitude

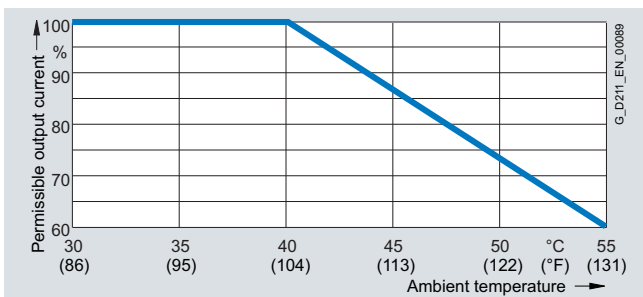

Output current as a function of ambient temperature

### Selection and ordering data

Rated output current A	Rated power kW (HP)	Suitable for PM340 Power Module		Line reactor
		Type	Frame size	Order No.
<b>Line voltage 200 ... 240 V 1 AC</b>				
0.9	0.12 (0.2)	6SL3210-1SB11-0...	FSA	<b>6SE6400-3CC00-4AB3</b>
2.3	0.37 (0.5)	6SL3210-1SB12-3...		
3.9	0.75 (1)	6SL3210-1SB14-0...	FSA	<b>6SE6400-3CC01-0AB3</b>
<b>Line voltage 380 ... 480 V 3 AC</b>				
1.3	0.37 (0.5)	6SL3210-1SE11-3UA0	FSA	<b>6SE6400-3CC00-2AD3</b>
1.7	0.55 (0.75)	6SL3210-1SE11-7UA0		
2.2	0.75 (1)	6SL3210-1SE12-2UA0	FSA	<b>6SE6400-3CC00-4AD3</b>
3.1	1.1 (1.5)	6SL3210-1SE13-1UA0		
4.1	1.5 (2)	6SL3210-1SE14-1UA0	FSA	<b>6SE6400-3CC00-6AD3</b>
5.9	2.2 (3)	6SL3210-1SE16-0...	FSB	<b>6SL3203-0CD21-0AA0</b>
7.7	3 (5)	6SL3210-1SE17-7...		
10	4 (5)	6SL3210-1SE21-0...	FSB	<b>6SL3203-0CD21-4AA0</b>
18	7.5 (10)	6SL3210-1SE21-8...	FSC	<b>6SL3203-0CD22-2AA0</b>
25	11 (15)	6SL3210-1SE22-5...		
32	15 (20)	6SL3210-1SE23-2...	FSC	<b>6SL3203-0CD23-5AA0</b>
38	18.5 (25)	6SL3210-1SE23-8...	FSD	<b>6SL3203-0CJ24-5AA0</b>
45	22 (30)	6SL3210-1SE24-5...		
60	30 (40)	6SL3210-1SE26-0...	FSD	<b>6SL3203-0CD25-3AA0</b>
75	37 (50)	6SL3210-1SE27-5...	FSE	<b>6SL3203-0CJ28-6AA0</b>
90	45 (60)	6SL3210-1SE31-0...		
110	55 (75)	6SL3210-1SE31-1...	FSF	<b>6SE6400-3CC11-2FD0</b>
145	75 (100)	6SL3210-1SE31-5...		
178	90 (125)	6SL3210-1SE31-8...	FSF	<b>6SE6400-3CC11-7FD0</b>

### Line filter

#### Selection and ordering data

Suitable for Power Module PM340 Frame size FSA	Line filter
Type	Order No.
<b>Line voltage 380 ... 480 V 3 AC</b>	
6SL3210-1SE11-...	<b>6SE6400-2FA00-6AD0</b>
6SL3210-1SE12-...	
6SL3210-1SE13-...	
6SL3210-1SE14-...	

# SINAMICS S110

## DC link components

### Braking resistors

#### Overview



Braking resistors in Blocksize format, frame size FSA and FSC

The PM340 Power Modules cannot regenerate into the line supply. For regenerative operation, e.g. the braking of a rotating mass, a braking resistor must be connected to convert the resulting energy into heat.

The braking resistor is connected at terminals DCP/R1 and R2.

The braking resistors can be installed at the side next to the PM340 Power Modules. The braking resistors for the FSA and FSB frame sizes are designed as base components. If the PM340 Power Modules of the FSA or FSB frame sizes are operated without line reactor, the braking resistors can also be installed under the Power Modules.

The braking resistors for the Power Modules of the FSC to FSF frame sizes should be placed outside the control cabinet or the switchgear room in order to direct the resulting heat loss away from the Power Modules, thereby allowing a corresponding reduction in the level of air conditioning required.

The braking resistors are designed with a temperature switch. The temperature switch must be evaluated to prevent consequential damage if the braking resistor overheats. This can be done, for example, via an entry of the Control Unit while configuring a correspondant error.

#### Selection and ordering data

	Suitable for PM340 Power Module Blocksize format	Order No.
<b>DC link voltage 240 ... 360 V DC</b> (Line voltage 200 ... 240 V 1 AC)		
<b>Braking resistor</b>		
180 Ω	Frame size FSA	<b>6SE6400-4BC05-0AA0</b>
<b>DC link voltage 510 ... 720 V DC</b> (Line voltage 380 ... 480 V 3 AC)		
<b>Braking resistor</b>		
390 Ω	Frame size FSA	<b>6SE6400-4BD11-0AA0</b>
160 Ω	Frame size FSB	<b>6SL3201-0BE12-0AA0</b>
56 Ω	Frame size FSC	<b>6SE6400-4BD16-5CA0</b>
27 Ω	Frame size FSD	<b>6SE6400-4BD21-2DA0</b>
15 Ω	Frame size FSE	<b>6SE6400-4BD22-2EA0</b>
8.2 Ω	Frame size FSF	<b>6SE6400-4BD24-0FA0</b>

#### Characteristic curves

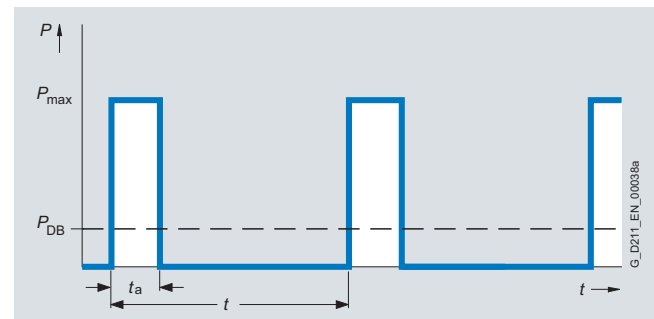

Load diagram for Braking Module in Blocksize format

$$t_a = 12 \text{ s}$$

$$t = 240 \text{ s}$$

#### More information

For further information see Catalog PM 21.  
<http://www.siemens.com/motioncontrol/docu>



### Technical specifications

DC link voltage 240 ... 360 V DC	Braking resistor  6SE6400-4BC05-0AA0
Resistor	180 Ω
Rated power $P_{DB}$	0.05 kW
Peak power $P_{max}$	1 kW
Degree of protection <sup>1)</sup>	IP20
Power connections	3 × 1.5 mm <sup>2</sup> (shielded)
• Length	0.5 m (1.64 ft)
Thermostatic switch (NC contact)	
• Switching capacity	250 V AC/max. 2.5 A
• Conductor cross section	0.5 ... 2.5 mm <sup>2</sup>
Dimensions	
• Width	72 mm (2.83 in)
• Height	230 mm (9.06 in)
• Depth	43.5 mm (1.71 in)
Weight, approx.	1.0 kg (2.2 lbs)
Approvals	cURus
Suitable for PM340 Power Module Blocksize format	FSA

DC link components 510 V ... 720 V DC		Braking resistor					
		6SE6400-4BD11-0AA0	6SL3201-0BE12-0AA0	6SE6400-4BD16-5CA0	6SE6400-4BD21-2DA0	6SE6400-4BD22-2EA0	6SE6400-4BD24-0FA0
Resistor	W	390	160	56	27	15	8.2
Rated power $P_{DB}$	kW	0.1	0.2	0.65	1.2	2.2	4.0
Peak power $P_{max}$	kW	1.7	4.1	12	24	44	80
Degree of protection <sup>1)</sup>		IP20	IP20	IP20	IP20	IP20	IP20
Power connections		3 × 1.5 mm <sup>2</sup> (shielded)	3 × 1.5 mm <sup>2</sup> (shielded)	3 × 1.5 mm <sup>2</sup> (shielded)	M6 screw studs	M6 screw studs	M6 screw studs
• Length	m	0.5 (1.64 ft)	0.5 (1.64 ft)	0.9 (2.95 ft)	–	–	–
Thermostatic switch (NC contact)							
• Switching capacity		250 V AC/ max. 2.5 A	250 V AC/ max. 2.5 A	250 V AC/ max. 2.5 A	250 V AC/ max. 2.5 A	250 V AC/ max. 2.5 A	250 V AC/ max. 2.5 A
• Conductor cross-section	mm <sup>2</sup>	0.5 ... 2.5	0.5 ... 2.5	0.5 ... 2.5	0.5 ... 2.5	0.5 ... 2.5	0.5 ... 2.5
Dimensions							
• Width	mm	72 (2.83 in)	153 (6.02 in)	185 (7.28 in)	270 (10.63 in)	270 (10.63 in)	400 (15.75 in)
• Height	mm	230 (9.06 in)	329 (12.95 in)	285 (11.22 in)	515 (20.28 in)	645 (25.39 in)	650 (25.59 in)
• Depth	mm	43.5 (1.71 in)	43.5 (1.71 in)	150 (5.91 in)	175 (6.89 in)	175 (6.89 in)	315 (12.40 in)
Weight, approx.	kg	1.0 (2.2 lbs)	1.6 (3.5 lbs)	3.8 (8.4 lbs)	7.4 (16.3 lbs)	10.6 (23.4 lbs)	16.7 (36.8 lbs)
Approvals		cURus	cURus	cURus	cURus	cURus	cURus
Suitable for PM340 Power Module Blocksize format		FSA	FSB	FSC	FSD	FSE	FSF

<sup>1)</sup> With correctly connected load connection cable.

# SINAMICS S110

## Supplementary system components

### BOP20 Basic Operator Panel

#### Overview



BOP20 Basic Operator Panel

The BOP20 Basic Operator Panel can be inserted on any CU305 Control Unit and may be used for fault acknowledgement, for parameter setting and for read-out of diagnostic information (e.g. warnings and faults).

#### Design

The BOP20 basic operator panel has a backlit two-line display area and 6 keys.

The integrated plug connector on the back is used for the power supply of the BOP20 and the communication with the Control Unit.

#### Integration



CU305 with mounted BOP20

#### Selection and ordering data

	Order No.
<b>BOP20 Basic Operator Panel</b>	<b>6SL3055-0AA0-4BA0</b>

# SINAMICS S120

## Modular drive system 0.12 kW to 4500 kW

System overview

### Overview



#### *SINAMICS S120 — The flexible, modular drive system for demanding drive tasks*

SINAMICS S120 is a modular drive system with servo and vector control that is ideal for sophisticated drive tasks in mechanical and plant engineering. Versions are available for both single-axis and multi-axis applications.

Covering power ranges of between 0.12 kW (0.16 HP) and 4500 kW (6000 HP) and featuring a variety of control modules classified according to function, the SINAMICS S120 modular system can be quickly and easily designed to meet the exact requirements of almost any high-performance drive configuration.

Even in their basic versions, the SINAMICS S120 Control Units feature extensive drive intelligence: servo and vector control, V/f control, positioning and safety functions, as well as numerous other useful functions required for ensuring reliable operation. The closed-loop control methods offered support synchronous and induction motors.

Integrated PROFIBUS DP interfaces ensure that SINAMICS S120 can be easily integrated in complete automation solutions.

PROFINET, among others, is another additional field bus interface that is supported.

Especially in conjunction with SIMATIC, the automation system from Siemens, it is possible to establish consistent, classical automation and drive solutions on the basis of a SINAMICS S120. And in conjunction with SIMOTION D or SINUMERIK 840D sl you can even construct complete motion control and processing machine solutions.

SINAMICS S120 is also available as cabinet modules specially designed for use in plant engineering applications that can be combined to create a row of drive cabinets with a total power of up to 4500 kW (6000 HP). Standardized interfaces enable the modules to be easily linked to a ready-to-connect drive solution for multi-motor applications.

#### *Cabinet Modules, the modular system for outputs of up to 4500 kW (6000 HP)*



4

# SINAMICS S120

## Modular drive system 0.12 kW to 4500 kW

### System overview

#### Integration

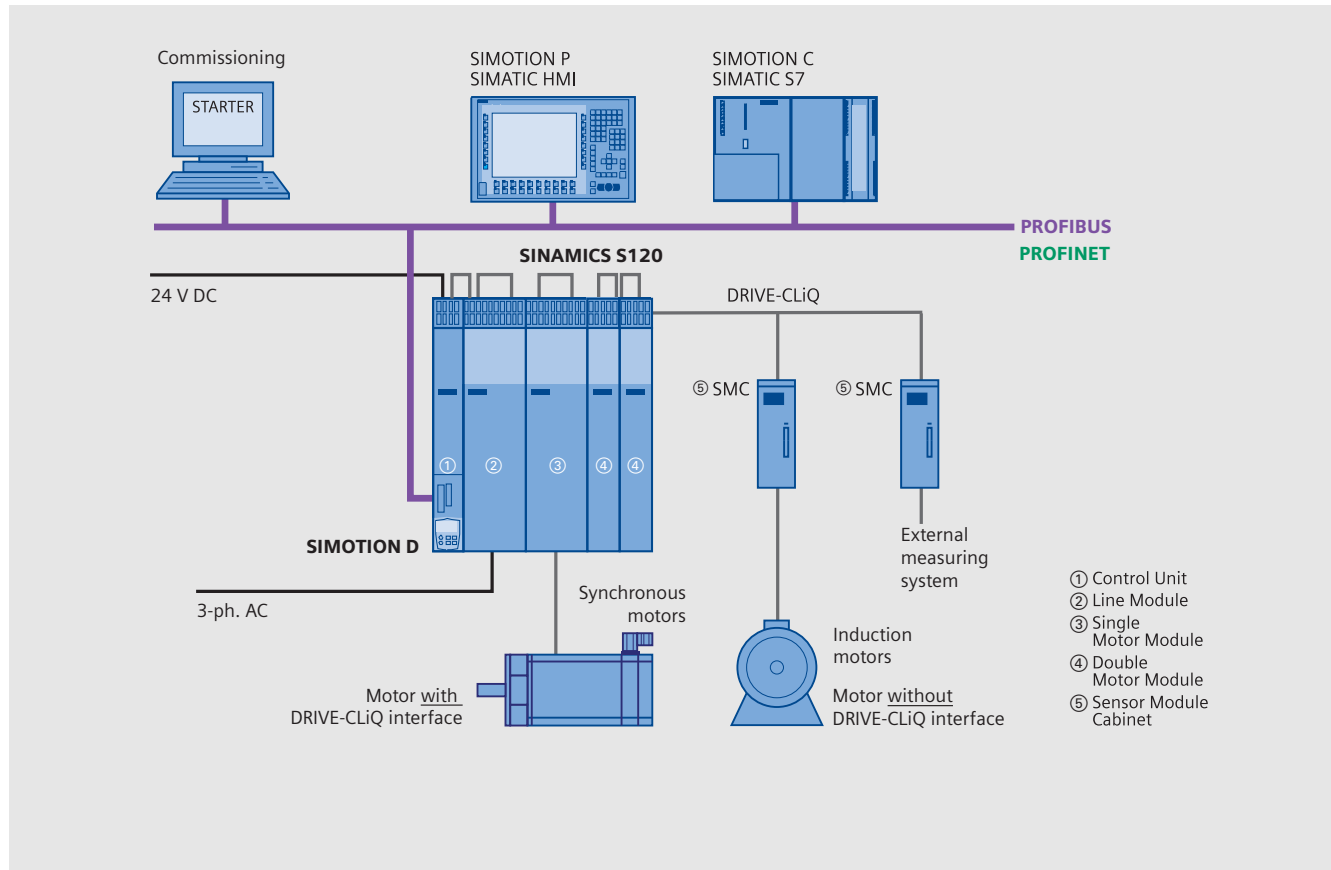

4

#### Applications

Regardless of whether the application involves continuous material webs or cyclic, highly dynamic processes – SINAMICS S120 means increased machine performance in many sectors:







- Packaging machines
- Plastics processing machines
- Textile machines
- Printing machines
- Paper machines
- Hoisting equipment
- Handling and assembly systems
- Machine tools
- Rolling mills
- Test stands for vehicles and transmissions

#### Benefits

SINAMICS S120 offers the following benefits:

- Universal application in high-performance single and multi-axis applications
- Can be combined as required to create customized solutions
- Broad power range
- Wide range of functions
- SINAMICS Safety Integrated functions
- Can support different cooling methods
- Can support different supply concepts
- Easy integration in higher-level automation and IT structure
- User friendliness
- Easy installation
- Practical connection system

### Design

SINAMICS S120 – Designs					
Modular drive systems for demanding single-axis and multi-axis applications					
Units for single-axis applications		Units for multi-axis applications			
Blocksize	Chassis	Booksize Compact	Booksize	Chassis	Cabinet Modules
					
0.12 – 90 kW	110 – 250 kW	0.9 – 9.7 kW	1.6 – 107 kW	75 – 4500 kW	1.6 – 4500 kW

SINAMICS S120 – The various designs and their respective power ranges

SINAMICS S120 devices are available as single drives or as multi-axis drive systems.

#### **SINAMICS S120 AC drives for high-performance single drives**

SINAMICS S120 AC drives were developed especially for single drives. They have a modular structure and comprise the following components: Power Module in which the power supply and power unit are integrated. Power Modules are available for outputs of 0.12 kW (0.16 HP) to 250 kW (340 HP). Connected to the Power Module is the Control Unit, which contains all the intelligent control functions as well as the drive interfaces for communication purposes and for connecting additional components.

#### **SINAMICS S120 DC/AC units for multi-axis applications**

Optimized for use in multi-axis applications, SINAMICS S120 multi-axis units feature a central power supply and DC link. They also have a modular structure and comprise the following components:

##### **Control Unit**

The Control Unit contains the control intelligence for all the drive axes integrated in the multi-axis line-up. It also contains drive-related I/Os and interfaces for communicating with higher-level controllers. Control Units are available with different ranges of functions and with different performance levels:

- Control Unit CU310 DP and CU310 PN
- Control Unit CU320
- Control Units SIMOTION D
- SINUMERIK 840D sl with NCU 7x0.2/7x0.2 PN

##### **Line Module**

The Line Module contains the central power supply for the DC link. Different Line Modules are available for different applications, including an unregulated infeed unit for motor mode and a regulated feed/feedback unit that provides a constant DC link voltage even if line voltage fluctuations occur and supplies excess energy back to the network. Line Modules are available for outputs of 5 kW (6.7 HP) to 6000 kW (8000 HP).

#### **Motor Modules**

One or more Motor Modules can be supplied with power for the motors via the DC link. Synchronous and induction motors can be operated. Motor Modules are available for rated outputs from 1.6 kW (2 HP) to 1200 kW (1600 HP).

#### **Other modules and components**

A wide range of additional modules and components are available for connecting different position measuring and encoder systems and for extending the drive system to include drive-related I/Os:

- Terminal Modules, Terminal Boards: for extending the drive system to include drive-related I/Os.
- Sensor Modules: for connecting position encoders to the drive system.
- Communication Boards: provide Control Units with an additional communication interface.

#### **DRIVE-CLiQ system interface**

All SINAMICS S120 components are connected easily via the high-performance DRIVE-CLiQ system interface.

Line and Motor Modules are connected to the Control Unit via DRIVE-CLiQ. Terminal and Sensor Modules are connected to the drive system. Motors with a DRIVE-CLiQ interface can be connected directly to the drive system.

#### **Different types and their combination.**

SINAMICS S120 is available in different types.

- SINAMICS S120 AC Drives
  - Compact Blocksize for power ratings 0.12 kW to 90 kW
  - Chassis for power ratings 110 kW to 250 kW
- SINAMICS S120 multi-axis devices
  - Booksize for power ratings 0.9 kW to 9.7 kW - with air cooling
  - Booksize for power ratings 1.6 kW to 107 kW - also available with external air cooling and in the Cold Plate version
  - Chassis for power ratings 75 kW to 1200 kW, supports liquid cooling (e.g. for applications in dusty, corrosive, or salty environments or if insufficient space is available)
  - Cabinet Modules for power ratings 1.6 kW to 4.500 kW

# SINAMICS S120

## Modular drive system 0.12 kW to 4500 kW

### System overview

All types support internal air cooling and can be combined with each other as required. Even SINAMICS S120 AC can be combined to handle multi-axis applications - through Control Unit Adapter CUA31/32 and DRIVE-CLiQ interface.

#### Auto-configuration with electronic type plate

All SINAMICS S120 components feature a digital type plate that stores all the relevant data about that particular component. For motors, this data includes the parameters of the electric equivalent circuit diagram and characteristic values of the built-in motor encoder. The Control Unit records this data automatically via DRIVE-CLiQ so that it does not need to be entered during commissioning or when the equipment is replaced.

In addition to the technical data, the digital rating plate stores logistical data (manufacturer ID, order number, and globally unique identification number). Since this data can be called up electronically on-site or remotely, all the components used in a machine can always be individually identified, which simplifies servicing.

### Technical data

Electrical data	
Line voltages	1 AC 200 ... 240 V, ± 10% 3 AC 380 ... 480 V, ± 10% 3 AC 660 ... 690 V, ± 10%
Power range	0.12 ... 1200 kW
Supported network types	IT, TN, TT
Line frequency	50 Hz, 60 Hz
Control methods	U/f closed loop Vector control Servo control Dynamic servo control (DSC)
Digital inputs and outputs	yes, scalable number
Analog inputs and outputs	yes, scalable number
Communication interfaces	Digital in/outputs, DC 24 V, Analog in/outputs, PROFIBUS DP, PROFINET, CANopen.
Functions	
Technological functions	<ul style="list-style-type: none"> <li>• Several command/drive data set</li> <li>• freely interconnectable through BICO technology,</li> <li>• flying measurement, flying restart, kinetic buffering,</li> <li>• Motion Control in conjunction with SIMOTION D,</li> <li>• numeric control in conjunction with SINUMERIK840solution line,</li> <li>• technology controller (PID),</li> <li>• integrated positioning functions</li> </ul>
Safety functions (Safety Integrated, depends on type)	<ul style="list-style-type: none"> <li>• Safe Torque Off (STO),</li> <li>• Safe Stop 1, Safe Stop 1 (SS1, SS2),</li> <li>• Safely Limited Speed (SLS),</li> <li>• Safe Speed Monitor (SSM),</li> <li>• Safe Brake Control (SBC).</li> </ul>
Limits	<ul style="list-style-type: none"> <li>• Torque limit/current limit,</li> <li>• Power limit,</li> <li>• Speed limit.</li> </ul>

Electrical data	
Protective functions (excerpt)	<ul style="list-style-type: none"> <li>• Temperature monitoring of motor and power sections</li> <li>• Overcurrents, overvoltages, undervoltages,</li> <li>• Blocking protection</li> <li>• Overspeed, Standstill,</li> <li>• Short circuit proof and ground fault proof.</li> </ul>
Setpoint processing	<ul style="list-style-type: none"> <li>• Direction of rotation reversal,</li> <li>• 4 skip bandwidths,</li> <li>• Basic ramp-function generator without rounding-off, with a special fast stopping ramp</li> <li>• Expanded ramp-function generator with rounding-off and setting functions Speed setpoint filter</li> </ul>
Connectable motors	<ul style="list-style-type: none"> <li>• Asynchronous motors,</li> <li>• Induction motors,</li> <li>• Synchronous motors,</li> <li>• Torque motors,</li> <li>• Linear motors.</li> </ul>
Supported encoders	<ul style="list-style-type: none"> <li>• Resolver,</li> <li>• Absolute encoders,</li> <li>• Incremental encoder sin/cos 1 V<sub>pp</sub>,</li> <li>• Incremental encoder TTL-Signal, RS422,</li> <li>• Incremental encoder HTL.</li> </ul>
Mechanical data	
Degree of protection	IP00 / IP20, optional up to IP54
Cooling methods	<ul style="list-style-type: none"> <li>• Internal or external air cooling,</li> <li>• liquid cooling,</li> <li>• Cold Plate cooling</li> </ul>
Standards	
Compliance with standards	CE, ®, cUL, Safety Integrated IEC 61508 / SIL 2

### Additional information

[www.siemens.com/sinamics-s120](http://www.siemens.com/sinamics-s120)

Catalog: PM 21, Order No.: E86060-K4921-A101-A2-7600

For more information regarding the internal safety functions see section „Safety Integrated“ (from page 4/60).

# SINAMICS S120

## Modular drive system 0.12 kW to 4500 kW

### Cabinet Modules

#### Overview



SINAMICS S120 Cabinet Modules are the components of a modular cabinet system for multi-axle drives with central power infeed and common DC link busbar, which are typical for paper machines, test stands, or hoisting equipment. As standard, they are installed side by side in a row. Other installation types (e.g. back to back) are possible on request.

The cabinet modules type SINAMICS S120 are available in Booksize (Motor Modules) and Chassis and therefore constitute a perfect addition to the cabinet line SINAMICS G150 and SINAMICS S150 for single drives.

All drive components, from the line infeed to the motor-side inverters, are configured in a clear, compact layout in the individual Cabinet Modules. They can be combined with great flexibility and can be optimally adapted to customer-specific requirements thanks to a comprehensive array of options.

The main components of the system are as follows:

- Line Connection Modules with line-side components such as contactors, fuses and circuit breakers, as well as line reactors for Basic Line Modules.
- Line Modules for the infeed in the following variations
  - Basic Line Modules for two-quadrant operation
  - Smart Line Modules for four-quadrant operation
  - Active Line Modules for four-quadrant operation with negligible line harmonics
- Central Braking Modules for braking operation
- The following types of Motor Modules
  - Booksize Kit
  - Chassis
- Control Units
- Auxiliary Power Supply Modules

Standardized interfaces for both the power and the control connections facilitate configuration and installation. Communication between the power modules and the central Control Unit takes place via DRIVE-CLiQ, the internal drive serial interface.

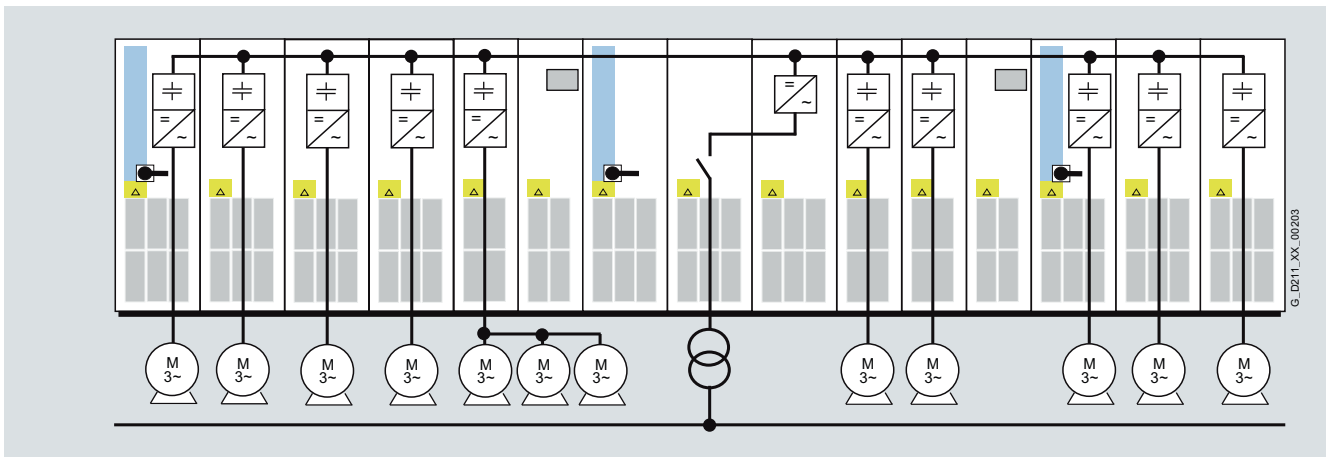

Example of a drive line-up with SINAMICS S120 Cabinet Modules for a multi-motor drive

#### More Information

[www.siemens.com/sinamics-s120](http://www.siemens.com/sinamics-s120)

Catalog: PM 21.3, chapter 3

# SINAMICS S120

## Modular drive system 0.12 kW to 4500 kW

### Cabinet Modules

#### Overview (continued)

The following table provides an overview of the voltage ranges and power ratings of the SINAMICS S120 Cabinet Modules

	Line voltage	Input current	DC link voltage	DC link current	Output current	Power range
<b>Line Connection Modules</b>	3 AC 380 ... 480 V	250 ... 3200 A				
	3 AC 500 ... 690 V	280 ... 3200 A				
<b>Basic Line Modules</b>	3 AC 380 ... 480 V	365 ... 1630 A	510 ... 650 V	420 ... 1880 A		200 ... 900 kW
	3 AC 500 ... 690 V	260 ... 1580 A	675 ... 930 V	300 ... 1880 A		250 ... 1500 kW
<b>Smart Line Modules</b>	3 AC 380 ... 480 V	463 ... 1430 A	510 ... 650 V	550 ... 1700 A		250 ... 800 kW
	3 AC 500 ... 690 V	463 ... 1430 A	675 ... 930 V	550 ... 1700 A		450 ... 1400 kW
<b>Active Line Modules</b>	3 AC 380 ... 480 V	210 ... 1405 A	540 ... 720 V	235 ... 1574 A		132 ... 900 kW
	3 AC 500 ... 690 V	575 ... 1270 A	710 ... 1035 V	644 ... 1422 A		560 ... 1400 kW
<b>Central Braking Modules</b>	3 AC 380 ... 480 V		510 ... 720 V			500 ... 1000 kW
	3 AC 500 ... 600 V		675 ... 900 V			550 ... 1100 kW
	3 AC 660 ... 690 V		890 ... 1035 V			630 ... 1200 kW
<b>Motor Modules Booksize</b>	3 AC 380 ... 480 V		510 ... 720 V	3,6 ... 200 A	3 ... 200 A	1.6 ... 107 kW
<b>Motor Modules Chassis</b>	3 AC 380 ... 480 V		510 ... 720 V	252 ... 1686 A	210 ... 1405 A	110 ... 800 kW
	3 AC 500 ... 690 V		675 ... 1035 V	102 ... 1524 A	85 ... 1270 A	75 ... 1200 kW

#### Benefits

The outstanding system features of the SINAMICS S120 Cabinet Modules provide plant operators with the following advantages:

- Process optimization with minimal effort:
  - A standard PROFIBUS interface and various analog and digital interfaces enables easy integration into automation solutions.
  - Vector control ensures that they fulfill the most exacting requirements regarding the accuracy and dynamic response of drives.
- High level of reliability and availability:
  - Individual modules and power components can be replaced quickly and easily, which ensures a higher level of plant availability.
- Energy savings during operation:
  - If the drive system includes motors that are operated in both the motoring and regenerating mode, then they can be coupled by means of a common DC link in such a way that allows energy to be transferred between them. Additional energy can be saved and the line harmonics reduced in this fashion. In certain cases, the line supply of the drive line-up can even be designed to supply less voltage than the total power of the individual Motor Modules operated on the common DC link would require.
- Cost minimization during operation, maintenance, and service:
  - Simple commissioning thanks to the menu-driven STARTER commissioning tool
  - Optional menu-driven AOP30 Advanced Operator Panel with a plain-text display.
  - All device modules are easily accessible, which makes them extremely service friendly.
- Space-saving design
- Environmentally-friendly operation:
  - The converters are exceptionally quiet and compact thanks to state-of-the-art IGBT power semiconductors and an innovative cooling concept.

#### Applications

SINAMICS S120 Cabinet Modules have been specially developed to allow simple construction of multi-motor systems. They are used for applications where several motors must be coordinated to realize a drive task as multi-motor drives in a drive line-up. Examples of such applications include:

- Paper machines
- Rolling mills
- Hoisting gear
- Test stands

#### Design

They have been designed as "zoned" units and therefore offer the highest possible standard of operational reliability. EMC measures have been rigorously implemented. With the help of simulated conditions, partitions have been designed to act as air guides and heat dissipation units.

Special measures used in the construction of the cabinets ensure that they remain mechanically durable over their entire life cycle.

Attention has been paid to providing a wide range of cable routing options and special design concepts are applied consistently to broaden the scope of application and simplify servicing. The units feature all the necessary connections and connecting elements. Thanks to their carefully considered configuration concept, cabinets are shipped in a ready-to-connect state or, in the case of multiple transport units, have been prepared for quick assembly. The selection you make is supported by an extensive range of options, harmonized and coordinated to various applications.

All components, from individual parts to the ready-to-connect cabinet, undergo rigorous testing throughout the entire production process. This guarantees a high level of functional reliability during installation and commissioning, as well as in operation.

The design of replaceable components is based on the principle that they must be quick and easy to change. In addition, the "SparesOnWeb" Internet tool makes it easy to view the spare parts that are available for the system components ordered. <sup>1)</sup>

<sup>1)</sup> The properties of S120 Cabinet Modules described in this catalog are not transferable to cabinet units constructed to meet the requirements of specific applications.



### Overview



The CU310 DP Control Unit provides the communications and open-loop/closed-loop control functions for a Power Module. The CU310 DP combined with a Power Module and CompactFlash Card creates a powerful single-axis AC drive with a PROFIBUS interface to a higher-level control.

### Design

CU310 DP Control Unit features the following interfaces as standard:

- 1 DRIVE-CLiQ socket for communication with other DRIVE-CLiQ devices, e.g. Sensor or Terminal Modules
- 1 PM-IF interface for communication with Power Modules in blocksize format
- 1 interface to the BOP20 Basic Operator Panel
- 1 PROFIBUS interface with PROFIdrive V4 profile
- 1 encoder evaluation  
The following encoder signals can be evaluated:
  - Incremental encoder TTL/HTL
  - SSI encoder without incremental signals
- 4 parameterizable digital inputs (floating)
- 4 parameterizable bidirectional digital inputs/digital outputs (non-floating)
- 1 serial RS232 interface
- 1 slot for the CompactFlash Card on which firmware and parameters are stored
- 3 test sockets and one reference ground for commissioning support
- 1 connection for the electronic power supply via the 24 V DC power supply connector
- 1 PE/ground conductor connection
- 1 safe standstill input (enable pulses) for controlling the connected PM340 Power Module
- 1 temperature sensor input (KTY84-130 or PTC)

The status of the CU310 DP Control Unit is indicated via multi-color LEDs.

A BOP20 Basic Operator Panel can also be snapped directly onto the CU310 DP Control Unit for diagnostic purposes.

As the firmware and parameter settings are stored on a plug-in CompactFlash Card, the Control Unit can be changed without the need for software tools.

### Integration

The CU310 DP Control Unit drives Power Modules in blocksize format via the PM-IF interface. In this case, other DRIVE-CLiQ components such as Sensor or Terminal Modules, can be connected to the DRIVE-CLiQ socket on the CU310 DP Control Unit.

Power Modules in chassis format are driven by the CU310 DP Control Unit via the DRIVE-CLiQ interface. With this option, Sensor and Terminal Modules must be connected to the free DRIVE-CLiQ sockets on the chassis Power Module.

Parameter settings can be changed with the BOP20 Basic Operator Panel. The BOP20 panel can also be snapped onto the CU310 DP Control Unit during operation to perform troubleshooting procedures.

The CU310 DP Control Unit and other connected components are commissioned and diagnosed with the STARTER commissioning tool. The CU310 DP Control Unit requires a CompactFlash Card with firmware version 2.4 or higher.

A CU310 DP Control Unit communicates with the higher-level control system using PROFIBUS and the PROFIdrive V4 profile.

An external 24 V power supply can be connected to the CU310 DP Control Unit when the power connection for the Power Module is not energized.

# SINAMICS S120

## Control units

### CU310 DP Control unit

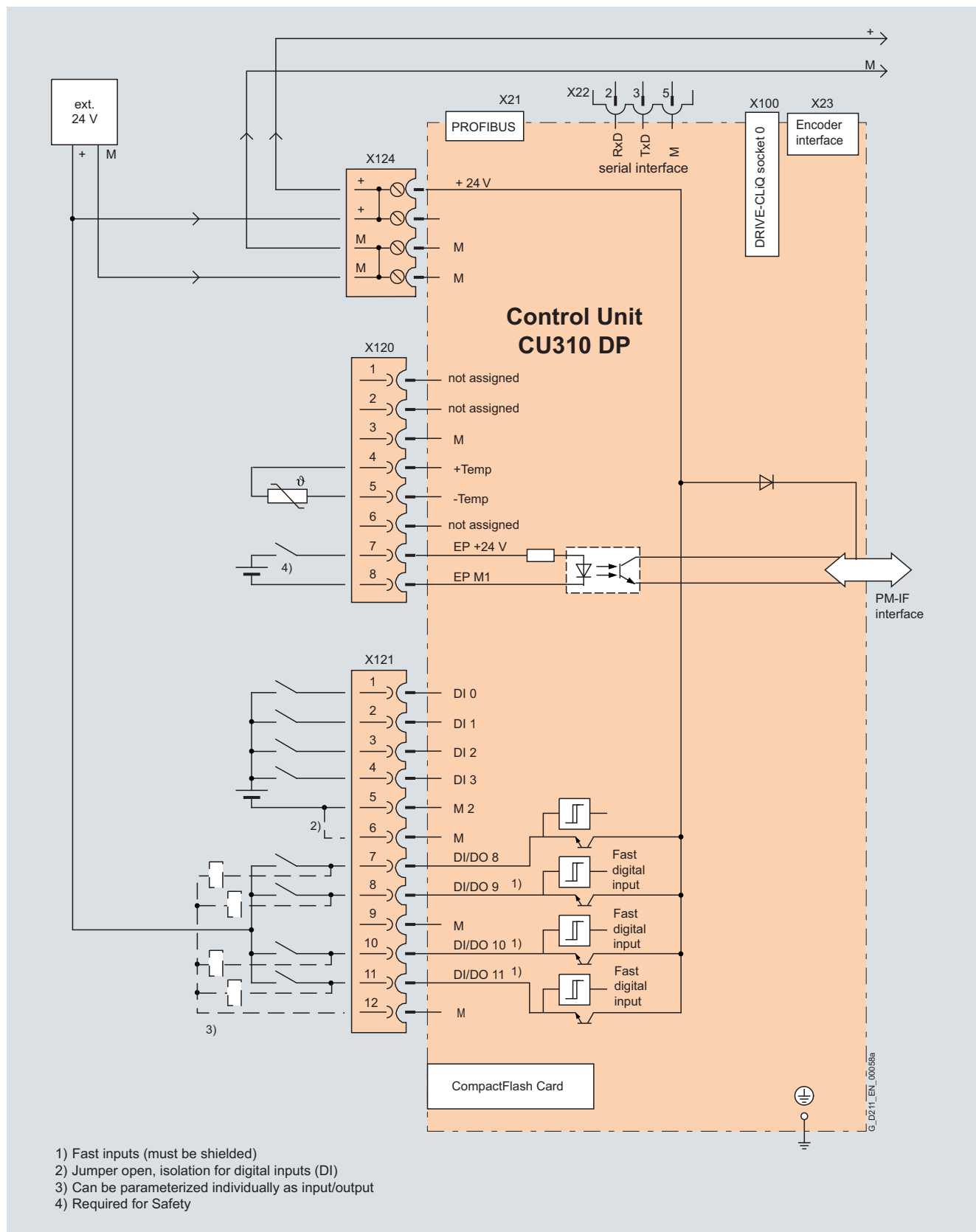

Connection example of CU310 DP Control Unit

### Technical specifications

<b>CU310 DP Control Unit</b>	6SL3040-0LA00-0AA1
<b>Power requirement, max.</b> At 24 V DC, without taking account of digital outputs and DRIVE-CLiQ supply	0.35 A for CU310 DP + 0.5 A for PM340 Power Module
<b>Conductor cross-section, max.</b>	2.5 mm <sup>2</sup>
<b>Fuse protection, max.</b>	20 A
<b>Digital inputs</b>	In accordance with IEC 61131-2 Type 1 4 x floating digital inputs 4 bidirectional non-floating digital inputs/digital outputs
• Voltage	-3 ... +30 V
• Low level (an open digital input is interpreted as "low")	-3 ... +5 V
• High level	15 ... 30 V
• Current consumption at 24 V DC, typ.	10 mA
• Delay time of digital inputs <sup>1)</sup> , approx.	
- L → H	50 μs
- H → L	100 μs
• Delay time of high-speed digital inputs <sup>1)</sup> , approx. (high-speed digital inputs can be used for position detection)	
- L → H	5 μs
- H → L	50 μs
• Conductor cross-section, max.	0.5 mm <sup>2</sup>
<b>Digital outputs</b>	4 bidirectional non-floating digital inputs/digital outputs
Sustained short-circuit strength	
• Voltage	24 V DC
• Load current per digital output <sup>2)</sup>	max. 500 mA
• Delay time <sup>1)</sup> , typ./max.	
- L → H	150 μs/400 μs
- H → L	75 μs/100 μs
• Conductor cross-section, max.	0.5 mm <sup>2</sup>
<b>Encoder evaluation</b>	<ul style="list-style-type: none"> <li>• Incremental encoder TTL/HTL</li> <li>• SSI encoder without incremental signals</li> </ul>
• Input impedance	
- TTL	570 Ω
- HTL, max.	16 mA
• Encoder supply	24 V DC/0.35 A or 5 V DC/0.35 A
• Encoder frequency, max.	300 kHz
• SSI baud rate	100 ... 250 kBaud
• Resolution absolute position SSI	30 bit
• Cable length, max.	
- TTL encoder	100 m (328 ft) (only bipolar signals permitted) <sup>3)</sup>
- HTL encoder	100 m (328 ft) for unipolar signals 300 m (984 ft) for bipolar signals <sup>3)</sup>
- SSI encoder	100 m (328 ft)
<b>Power loss</b>	< 20 W
<b>PE connection</b>	M5 screw
<b>Dimensions</b>	
• Width	73 mm (2.87 in)
• Height	183.2 mm (7.21 in)
• Depth	89.6 mm (3.53 in)
<b>Weight, approx.</b>	0.95 kg (2.09 lb)
<b>Approvals, according to</b>	cULus

<sup>1)</sup> The specified delay times refer to the hardware. The actual reaction time depends on the time slot in which the digital input or output is processed.

<sup>2)</sup> In order to use the digital outputs, an external 24 V power supply must be connected to terminal X124.

<sup>3)</sup> Signal cables twisted in pairs and shielded.

### Selection and ordering data

	Order No.
<b>CU310 DP Control Unit</b> Without CompactFlash Card	<b>6SL3040-0LA00-0AA1</b>
<i>Accessories</i>	
<b>PROFIBUS connectors</b>	
• Without PG/PC connection	<b>6ES7972-0BA41-0XA0</b>
• With PG/PC connection	<b>6ES7972-0BB41-0XA0</b>
<b>STARTER commissioning tool</b>	<b>6SL3072-0AA00-0AG0</b>
<i>Accessories for re-ordering</i>	
<b>Dust-proof blanking plugs</b> (50 units) For DRIVE-CLiQ port	<b>6SL3066-4CA00-0AA0</b>

For further information on connectors and cables, please refer to Catalog IK PI or the Siemens Industry Mall:  
<http://www.siemens.com/industrymall>

# SINAMICS S120

## Control units

### CU310 PN Control unit

#### Overview



The CU310 PN Control Unit is designed for the communication and open-loop/closed-loop control functions of a Power Module. The CU310 PN combined with a Power Module and CompactFlash Card creates a powerful single-axis AC drive. The communication link to the higher-level control is provided by PROFINET IO.

#### Design

CU310 PN Control Units feature the following interfaces as standard:

- 1 DRIVE-CLiQ socket for communication with other DRIVE-CLiQ devices, e.g. Sensor or Terminal Modules
- 1 PM-IF interface for communication with Power Modules in blocksize format
- 1 interface to the BOP20 Basic Operator Panel
- 1 PROFINET interface with 2 ports (RJ45 sockets) with PROFINET V4 profile
- 1 encoder evaluation
  - The following encoder signals can be evaluated:
    - Incremental encoder TTL/HTL
    - SSI encoder without incremental signals
- 4 parameterizable digital inputs (floating)
- 4 parameterizable bidirectional digital inputs/digital outputs (non-floating)
- 1 serial RS232 interface
- 1 slot for the CompactFlash Card on which firmware and parameters are stored
- 3 test sockets and one reference ground for commissioning support
- 1 connection for the electronic power supply via the 24 V DC power supply connector
- 1 safe standstill input (enable pulses) for controlling the connected PM340 Power Module
- 1 temperature sensor input (KTY84-130 or PTC)
- 1 PE/ground conductor connection

The status of the CU310 PN Control Unit is indicated via multi-color LEDs.

A BOP20 Basic Operator Panel can also be snapped directly onto the CU310 PN Control Unit for diagnostic purposes.

As the firmware and parameter settings are stored on a plug-in CompactFlash Card, the Control Unit can be changed without the need for software tools.

#### Integration

The CU310 PN Control Unit drives Power Modules in blocksize format via the PM-IF interface. In this case, other DRIVE-CLiQ components such as Sensor or Terminal Modules can be connected to the DRIVE-CLiQ socket on the CU310 PN Control Unit.

Power Modules in chassis format are driven by the CU310 PN Control Unit via the DRIVE-CLiQ interface. With this option, Sensor and Terminal Modules must be connected to the free DRIVE-CLiQ sockets on the Power Module.

Parameter settings can be changed with the BOP20 Basic Operator Panel. The BOP20 panel can also be snapped onto the CU310 PN Control Unit during operation to perform troubleshooting procedures.

The CU310 PN Control Unit and other connected components are commissioned and diagnosed with the STARTER commissioning tool. The CU310 PN Control Unit requires a CompactFlash Card with firmware version 2.4 or higher.

A CU310 PN Control Unit communicates with the higher-level control system using PROFINET IO and the PROFINET V4 profile.

The SINAMICS S120 drive system with CU310 PN then assumes the function of a PROFINET IO device and can perform the following functions:

- PROFINET IO device
- 100 Mbit/s full duplex
- Supports real-time classes of PROFINET IO:
  - RT (Real-Time)
  - IRT (Isochronous Real-Time), minimum send cycle 500  $\mu$ s
- Connects to controls as PROFINET IO devices using PROFINET compliant with Specification V4
- Standard TCP/IP communication for engineering processes using the STARTER commissioning tool
- Integrated 2-port switch with 2 RJ45 sockets based on the ERTEC ASIC. The optimum topology (line, star, tree) can therefore be configured without additional external switches.

An external 24 V power supply can be connected to the CU310 PN Control Unit when the power connection for the Power Module is not occupied.

### CU310 PN Control unit

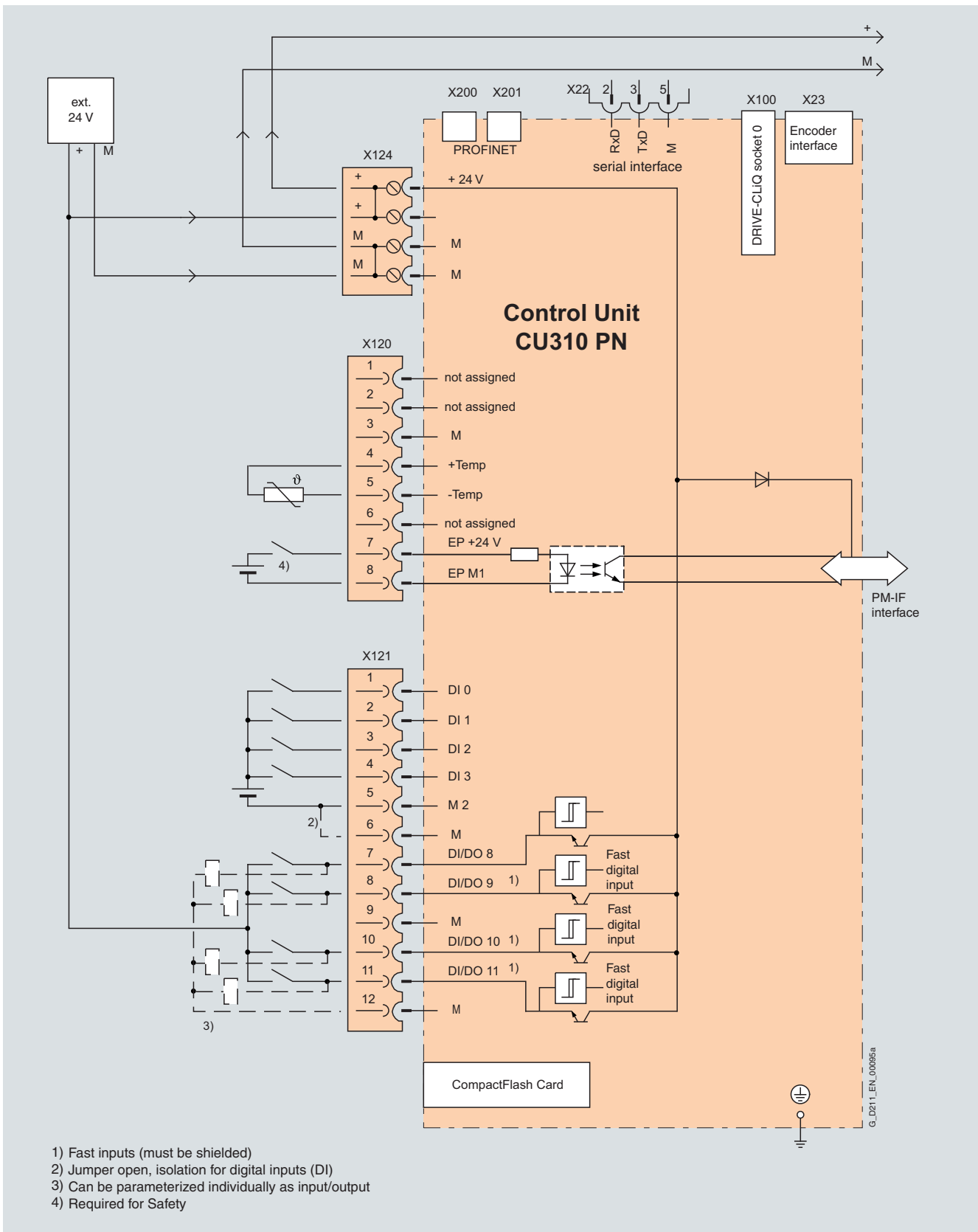

4

Connection example of CU310 PN Control Unit

# SINAMICS S120

## Control units

### CU310 PN Control unit

#### Technical specifications

<b>CU310 PN Control Unit</b>	6SL3040-0LA01-0AA1
<b>Power requirement, max.</b> At 24 V DC without taking account of digital outputs and DRIVE-CLiQ supply	0.4 A for CU310 PN + 0.5 A for PM340 Power Module
<b>Conductor cross-section, max.</b>	2.5 mm <sup>2</sup>
<b>Fuse protection, max.</b>	20 A
<b>Digital inputs</b>	In accordance with IEC 61131-2 Type 1 4 x floating digital inputs 4 bidirectional non-floating digital inputs/digital outputs -3 ... +30 V -3 ... +5 V
• Voltage	
• Low level (an open digital input is interpreted as "low")	
• High level	15 ... 30 V
• Current consumption at 24 V DC	typ. 10 mA
• Delay time of digital inputs <sup>1)</sup> , approx.	
- L → H	50 μs
- H → L	100 μs
• Delay time of high-speed digital inputs <sup>1)</sup> , approx. (high-speed digital inputs can be used for position detection)	
- L → H	5 μs
- H → L	50 μs
• Conductor cross-section, max.	0.5 mm <sup>2</sup>
<b>Digital outputs</b>	4 bidirectional non-floating digital inputs/digital outputs
Sustained short-circuit strength	24 V DC
• Voltage	
• Load current per digital output <sup>2)</sup> , max.	500 mA
• Delay time <sup>1)</sup> , typ./max.	
- L → H	150 μs/400 μs
- H → L	75 μs/100 μs
• Conductor cross-section, max.	0.5 mm <sup>2</sup>
<b>Encoder evaluation</b>	• Incremental encoder TTL/HTL • SSI encoder without incremental signals
• Input impedance	
- TTL	570 Ω
- HTL, max.	16 mA
• Encoder supply	24 V DC/0.35 A or 5 V DC/0.35 A
• Encoder frequency, max.	300 kHz
• SSI baud rate	100 ... 250 kBaud
• Resolution absolute position SSI	30 bit
• Cable length, max.	
- TTL encoder	100 m (328 ft) (only bipolar signals permitted) <sup>3)</sup>
- HTL encoder	100 m (328 ft) for unipolar signals 300 m (984 ft) for bipolar signals <sup>3)</sup>
- SSI encoder	100 m (328 ft)
<b>Power loss</b>	< 20 W (0.03 HP)
<b>PE connection</b>	M5 screw
<b>Dimensions</b>	
• Width	73 mm (2.87 in)
• Height	183.2 mm (7.21 in)
• Depth	89.6 mm (3.53 in)
<b>Weight, approx.</b>	0.95 kg (2.09 lb)
<b>Approvals, according to</b>	cULus

<sup>1)</sup> The specified delay times refer to the hardware. The actual reaction time depends on the time slot in which the digital input or output is processed.

<sup>2)</sup> In order to use the digital outputs, an external 24 V power supply must be connected to terminal X124.

<sup>3)</sup> Signal cables twisted in pairs and shielded.

#### Selection and ordering data

	Order No.
<b>CU310 PN Control Unit</b> Without CompactFlash Card	<b>6SL3040-0LA01-0AA1</b>
<i>Accessories</i>	
<b>STARTER commissioning tool</b>	<b>6SL3072-0AA00-0AG0</b>
<b>Industrial Ethernet FC</b>	
• RJ45 Plug 180 (1 unit)	<b>6GK1901-1BB10-2AA0</b>
• RJ45 Plug 180 (10 units)	<b>6GK1901-1BB10-2AB0</b>
• Stripping tool	<b>6GK1901-1GA00</b>
• Standard cable GP 2x2	<b>6XV1840-2AH10</b>
• Flexible cable GP 2x2	<b>6XV1870-2B</b>
• Trailing cable GP 2x2	<b>6XV1870-2D</b>
• Trailing cable 2x2	<b>6XV1840-3AH10</b>
• Marine cable 2x2	<b>6XV1840-4AH10</b>
<i>Accessories for re-ordering</i>	
<b>Dust-proof blanking plugs</b> (x 50)	<b>6SL3066-4CA00-0AA0</b>
For DRIVE-CLiQ port	

For further information on connectors and cables, please refer to Catalog IK PI or the Siemens Industry Mall:

<http://www.siemens.com/industrymall>

# SINAMICS S120

## CompactFlash Card for CU310

### Overview



The CompactFlash Card contains the firmware and parameter settings. The CompactFlash Card is plugged into a slot located on the CU310 Control Unit.

### Design

A CU310 Control Unit can perform the communication, open-loop and closed-loop control functions for one Power Module. The performance expansion is not required in this case.

In addition to the firmware, the CompactFlash Card also contains licensing codes which are required to enable firmware options. To order the Safety Integrated Extended Functions (Safe Stop 2, Safe Operating Stop, Safely Limited Speed, Safe Speed Monitor), order codes must be stated (**F.**) in addition to the Order No. for each axis.

The firmware options can also be enabled on-site, for example, if the performance expansions required are not known at the time of placing the order or the Safety Integrated Extended Functions are to be enabled retrospectively. You will need the serial number of the CompactFlash Card and the order number of the firmware option to be enabled. With this information, you can purchase the associated from a license database and enable the firmware option. The license code is only valid for the CompactFlash Card declared and cannot be transferred to other CompactFlash Cards.

### Selection and ordering data

	Order No.
<b>CompactFlash card for CU310 DP, CU310 PN Control Units</b>	<b>6SL3054-0CG00-1AA0</b>
With firmware version 2.6, including Certificate of License	
• With safety license for 1 axis	<b>6SL3054-0CG00-1AA0-Z F01</b>
<b>Firmware license</b>	<b>6SL3074-0AA10-0AA0</b>
Safety Integrated Extended Functions option including Certificate of License for one axis for upgrading the license of a CompactFlash card.	

### More information

#### Firmware version

The firmware version is encoded as follows in the order number printed on the CompactFlash card:

Order No.	6SL3054-	0	■	■	0	0	-1AA0
Firmware version							
	1						B
	2						C
Version							
	.1						B
	.2						C
	.3						D
	.4						E
	.5						F
	.6						G

#### Example 1

A CompactFlash card with firmware version 2.5 and a Safety license for a CU310 PN Control Unit are required:  
 Order No. 6SL3054-0CF00-1AA0-Z  
 F01

# SINAMICS S120

## Control units

### CU320-2 DP Control unit

#### Overview



The communication, open-loop and closed-loop control functions for one or more Motor Modules and the Line Module are executed in a CU320-2 DP Control Unit. The CU320-2 DP Control Unit is designed for multi-axis operation.

#### Design

4



CU320-2 DP Control Unit with BOP20 Basic Operator Panel

The CU320-2 DP Control Unit has the following interfaces and connections as standard:

- 4 x DRIVE-CLiQ sockets for communication with other DRIVE-CLiQ devices, e.g., Motor Modules, Active Line Modules, Sensor Modules, Terminal Modules
- 1 PROFIBUS interface with PROFIdrive V4 profile
- 12 parameterizable digital inputs (floating)
- 8 parameterizable bidirectional digital inputs/digital outputs (non-floating)
- 1 serial RS232 interface
- 1 interface for the BOP20 Basic Operator Panel
- 1 slot for the CompactFlash Card on which firmware and parameters are stored
- 1 slot for mounting an option module (e.g. TB30 Terminal Board)
- 2 rotary coding switches for manually setting the PROFIBUS address
- 1 Ethernet interface for commissioning and diagnostics
- 3 test sockets and one reference ground for commissioning support
- 1 connection for the electronics power supply via the 24 V DC power supply connector
- 1 PE (protective earth) connection
- 1 ground connection

A shield connection for the signal cable shield on the option module is located on the CU320-2 DP Control Unit.

The available option slot is used to expand the interfaces, for example, to include additional terminals or for communication purposes.

The status of the CU320-2 DP Control Unit is indicated via multi-color LEDs.

As the firmware and parameter settings are stored on a plug-in CompactFlash Card, the Control Unit can be changed without the need for software tools.

The CU320-2 DP Control Unit can be mounted on the side of the Line Module in booksize format via brackets integrated in a Line Module. The CU320-2 DP Control Unit can also be fixed to the wall of the control cabinet using the integrated fixing lugs. As the CU320-2 DP Control Unit is not as deep as the Line Modules, suitable spacers are available to increase the depth of the CU320-2 DP Control Unit to 270 mm (10.63 in).

#### Integration

DRIVE-CLiQ components, for example, Motor Modules and Active Line Modules, can be connected to a CU320-2 DP Control Unit. The number of modules depends on the performance required, including duty type and additional functions.

The BOP20 Basic Operator Panel can also be snapped onto the CU320-2 DP Control Unit during operation to perform troubleshooting procedures.

The CU320-2 DP Control Unit and other connected components are commissioned and diagnosed with the STARTER commissioning tool (version 4.1 and higher, SP5) and installed SINAMICS Support Package SSP\_SINAMICS\_V4\_3\_1.

The CU320-2 DP Control Unit requires a CompactFlash Card with firmware version 4.3 or higher.





# SINAMICS S120

## Control units

### CU320-2 DP Control unit

#### Technical specifications

##### CU320-2 DP Control Unit 6SL3040-1MA00-0AA0

<b>Power requirement, max.</b> At 24 V DC, without taking account of digital outputs, expansion option slot and DRIVE-CLiQ supply	1.0 A
<b>Conductor cross-section, max.</b>	2.5 mm <sup>2</sup>
<b>Fuse protection, max.</b>	20 A
<b>Digital inputs</b>  <ul style="list-style-type: none"> <li>• Voltage</li> <li>• Low level (an open digital input is interpreted as "low")</li> <li>• High level</li> <li>• Current consumption at 24 V DC, typ.</li> <li>• Delay time of digital inputs <sup>1)</sup>, approx. <ul style="list-style-type: none"> <li>- L → H</li> <li>- H → L</li> </ul> </li> <li>• Conductor cross-section, max.</li> </ul>	In accordance with IEC 61131-2 type 1 12 x floating digital inputs 8 bidirectional non-floating digital inputs/digital outputs -3 ... +30 V -3 ... +5 V 15 ... 30 V 9 mA 5 μs 50 μs 1.5 mm <sup>2</sup>
<b>Digital outputs</b> Sustained short-circuit strength <ul style="list-style-type: none"> <li>• Voltage</li> <li>• Load current per digital output, max.</li> <li>• Delay time <sup>1)</sup>, typ./max. <ul style="list-style-type: none"> <li>- L → H</li> <li>- H → L</li> </ul> </li> <li>• Conductor cross-section, max.</li> </ul>	8 bidirectional non-floating digital inputs/digital outputs 24 V DC 500 mA 150 μs/400 μs 75 μs/100 μs 1.5 mm <sup>2</sup>
<b>Power loss</b>	24 W
<b>PE connection</b>	M5 screw
<b>Ground connection</b>	M5 screw
<b>Dimensions</b> <ul style="list-style-type: none"> <li>• Width</li> <li>• Height</li> <li>• Depth</li> </ul>	50 mm (1.97 in) 300 mm 226 mm (8.90 in)
<b>Weight, approx.</b>	2.3 kg
<b>Approvals, according to</b>	cULus

<sup>1)</sup> The specified delay times refer to the hardware. The actual reaction time depends on the time slot in which the digital input or output is processed.

#### Selection and ordering data

	Order No.
<b>CU320-2 DP Control Unit</b> Without CompactFlash card	<b>6SL3040-1MA00-0AA0</b>
<i>Accessories</i>	
<b>PROFIBUS connectors</b> <ul style="list-style-type: none"> <li>• Without PG/PC connection</li> <li>• With PG/PC connection</li> </ul>	<b>6ES7972-0BA41-0XA0</b> <b>6ES7972-0BB41-0XA0</b>
<b>Spacers</b> (2 units)  For increasing the depth of the CU320-2 DP Control Unit to 270 mm (if the integrated brackets are not used, but the depth still has to be 270 mm)	<b>6SL3064-1BB00-0AA0</b>
<b>STARTER commissioning tool</b>	<b>6SL3072-0AA00-0AG0</b>
<i>Accessories for re-ordering</i>	
<b>Dust-proof blanking plugs</b> (50 units)  For DRIVE-CLiQ port	<b>6SL3066-4CA00-0AA0</b>



# SINAMICS S120

## Control units

### TM54F terminal module

#### Overview

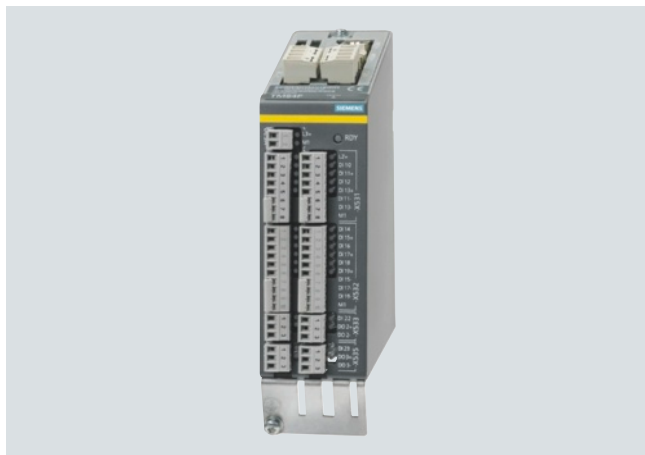

The TM54F Terminal Module is a dual-processor I/O interface with 4 fail-safe digital outputs and 10 fail-safe digital inputs for utilization of the Safety Integrated functions of the SINAMICS S120 drive system over external actuators and sensors.

Every available safety function integrated in the drive can be controlled via the fail-safe digital inputs on the TM54F Terminal Module. In cases where the parameterized safety functions of multiple drives operated on a CU320-2 or SIMOTION D4x5 must be executed on a group basis, the relevant drives can be combined into groups in the TM54F Terminal Module. The advantage of this approach is that only one fail-safe digital input needs to be connected for these drives.

The fail-safe digital inputs and outputs are redundantly configured with internal, cross-over data comparison using the two processors. A fail-safe digital output consists of one current sourcing and one current sinking output as well as a digital input for reading back the switching state. A fail-safe digital input consists of two digital inputs.

Safety sensors can be connected over two switchable 24 V sensor supplies and can be evaluated over the fail-safe digital inputs. The switchable 24 V sensor supply ensures that the fail-safe digital inputs can be dynamized for error discovery (dynamization allows switch-off signal paths to be checked). An unswitchable 24 V sensor supply is additionally provided by the TM54F Terminal Module for connecting undynamizable safety sensors.

The TM54F Terminal Module must be connected to a CU310, CU320-2 or SIMOTION D Control Unit via a DRIVE-CLiQ cable. Only one TM54F Terminal Module can be assigned to each Control Unit. It is not permissible to make the TM54F connection via another DRIVE-CLiQ device, e.g. a Motor Module or Line Module.

#### Design

The following are located on the TM54F Terminal Module:

- 4 fail-safe digital outputs
- 10 fail-safe digital inputs
- 4 LEDs, single color for indicating the status of the read back channel of the fail-safe digital outputs
- 4 LEDs, dual-color for indicating the status of the fail-safe digital outputs
- 20 LEDs, dual-color for indicating the status of the fail-safe digital inputs
- 3 LEDs, single color for indicating the status of the 24 V sensor supplies
- 2 DRIVE-CLiQ sockets

- 2 connections for 24 V sensor supply, switchable
- 1 connection for 24 V sensor supply, not switchable
- 1 connection for the electronics power supply via the 24 V DC power supply connector
- 1 connection for the 24 V power supply to digital outputs and sensors
- 1 PE/ground conductor connection

The TM54F Terminal Module can be snapped on a TH 35 top-hat rail in accordance with EN 60715 (IEC 60715).

The signal cable shield can be connected to the TM54F Terminal Module via a terminal element, e.g. Phoenix Contact type SK8 or Weidmüller type KLBÜ CO 1. The terminal element must not be used for strain relief.

The status of the TM54F Terminal Module is indicated via a multi-color LED.

Pins for connector coding are supplied with the TM54F Terminal Module.

#### Integration

The TM54F Terminal Module communicates with a CU310, CU320-2, SIMOTION D or SIMOTION CX32 Control Unit via DRIVE-CLiQ.

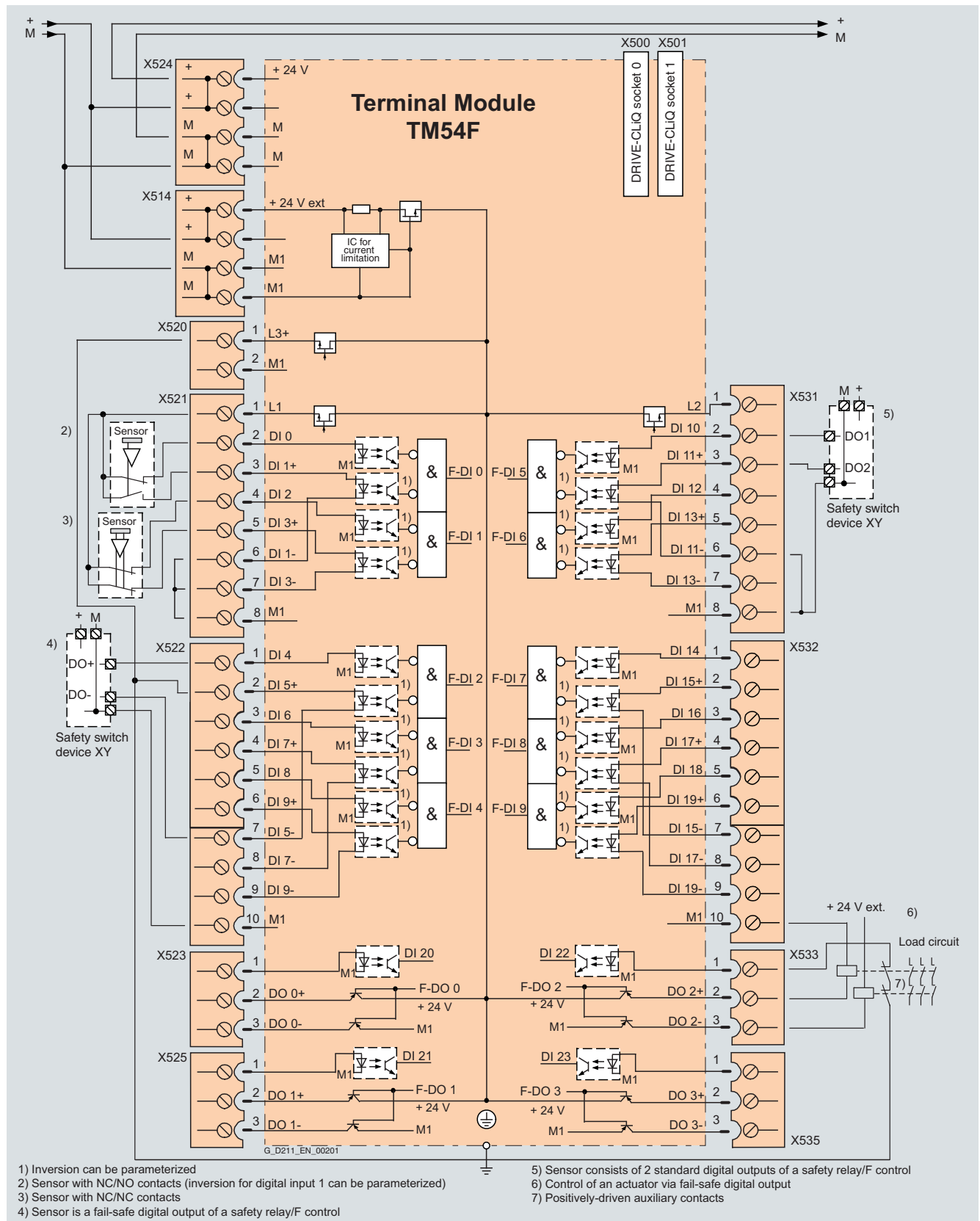

Connection example of TM54F Terminal Module

# SINAMICS S120

## Control units

### TM54F terminal module

#### Technical specifications

<b>TM54F Terminal Module</b>	6SL3055-0AA00-3BA0
<b>Current requirement</b> (X524 at 24 V DC) without DRIVE-CLiQ supply	0.2 A
<ul style="list-style-type: none"> <li>• Conductor cross-section, max.</li> <li>• Fuse protection, max.</li> </ul>	2.5 mm <sup>2</sup> 20 A
<b>Max. current requirement ext. 24 V</b>	4 A
For supplying the digital outputs and 24 V sensor supply (X514 at 24 V DC)	
<ul style="list-style-type: none"> <li>• Conductor cross-section, max.</li> <li>• Fuse protection, max.</li> </ul>	2.5 mm <sup>2</sup> 20 A
<b>I/O</b>	
<ul style="list-style-type: none"> <li>• Number of fail-safe digital inputs</li> <li>• Number of fail-safe digital outputs</li> <li>• 24 V sensor supply</li> </ul>	10 4 3, of which 2 can be temporarily shut down using an internal test routine for dynamizing fail-safe digital inputs, current carrying capacity 0.5 A each
<ul style="list-style-type: none"> <li>• Cables and connections</li> <li>• Conductor cross-section, max.</li> </ul>	Plug-in screw-type terminals 1.5 mm <sup>2</sup>
<b>Digital inputs</b>	
According to IEC 61131-2 Type 1, with isolation	
<ul style="list-style-type: none"> <li>• Voltage</li> <li>• Low level (an open digital input is interpreted as "low")</li> <li>• High level</li> <li>• Current consumption at 24 V DC, typ.</li> <li>• Delay time of digital inputs, approx. <sup>1)</sup> <ul style="list-style-type: none"> <li>- L → H, typ.</li> <li>- H → L, typ.</li> </ul> </li> <li>• Safe state</li> </ul>	-3 ... +30 V -3 ... +5 V 15 ... 30 V > 2 mA 30 μs 60 μs Low level (for inputs that can be inverted: without inversion)
<b>Digital outputs</b>	
(sustained short-circuit strength)	
<ul style="list-style-type: none"> <li>• Voltage</li> <li>• Load current per fail-safe digital output, max. <sup>2)</sup></li> <li>• Delay times (ohmic load) <sup>1)</sup> <ul style="list-style-type: none"> <li>- L → H, typ.</li> <li>- H → L, typ.</li> </ul> </li> <li>• Safe state</li> </ul>	24 V DC 0.5 A 300 μs 350 μs Output switched off
<b>Scanning cycle <math>t_{SI}</math></b>	4 ... 25 ms (adjustable)
For fail-safe digital inputs or fail-safe digital outputs	
<b>PE connection</b>	M4 screw
<b>Dimensions</b>	
<ul style="list-style-type: none"> <li>• Width</li> <li>• Height</li> <li>• Depth</li> </ul>	50 mm (1.97 in) 150 mm (5.91 in) 111 mm (4.37 in)
<b>Weight, approx.</b>	0.9 kg (2 lb)
<b>Approvals, according to</b>	cULus
<b>Safety Integrated</b>	Safety Integrity Level 2 (SIL2) acc. to IEC 61508, Performance Level d (PLd) acc. to ISO 13849-1 and Control Category 3 acc. to ISO 13849-1 or EN 954-1

<sup>1)</sup> The specified delay times refer to the hardware. The actual reaction time depends on the time slot in which the digital input/output is processed.

<sup>2)</sup> The total current of all fail-safe digital outputs must not exceed 5.33 A.

#### Selection and ordering data

	Order No.
<b>TM54F Terminal Module</b> Without DRIVE-CLiQ cable	<b>6SL3055-0AA00-3BA0</b>
<i>Accessories</i>	
<b>Dust-proof blanking plugs</b> (50 units) For DRIVE-CLiQ ports	<b>6SL3066-4CA00-0AA0</b>

# SINAMICS S150

## Drive converter cabinet units 75 kW to 1200 kW

### System overview

#### Overview



SINAMICS S150 drive converter cabinet unit

SINAMICS S150 drive converter cabinet units are particularly suitable for all variable-speed single-axis drives with high performance requirements, i.e. drives with:

- High dynamic response requirements
- Frequent braking cycles with high braking energy
- Four-quadrant operation.

SINAMICS S150 provides high-performance speed control with a high accuracy and dynamic response.

They are available for the following voltages and outputs:

Voltage	Power
3 AC 380 ... 480 V	110 ... 800 kW
3 AC 500 ... 690 V	75 ... 1200 kW

Degrees of protection are IP20 (standard), and as an option IP21, IP23, IP43 and IP54.

The drive converter cabinet units make it possible to install line side and motor side components as well as additional monitoring units.

A wide range of electrical and mechanical components enable the drive system to be optimized for the respective requirements.

#### Benefits

The self-commutating, pulsed rectifier/feedback unit which is based on IGBT technology and is equipped with a Clean Power Filter makes the minimum of demands on the line, which is characterized by the following features:

- The innovative Clean Power Filter minimizes line harmonics
- Power feedback (four-quadrant operation)
- Tolerant towards fluctuations in line voltage
- High line stability (high availability)
- Operation on weak power supplies
- Reactive power compensation is possible (inductive or capacitive)
- High drive dynamics.

Simple handling of the drive from configuration to operation as a result of:

- Compact and modular, service-friendly design
- Straightforward planning and design
- Ready to connect to facilitate the installation process
- Fast, menu-prompted commissioning with no complex parameterization
- Clear and convenient operation via a user-friendly graphical operator control panel with measured values displayed in plain text or in a quasi-analog bar display

#### Applications

Typical applications for SINAMICS S150 include:

- Test bay drives,
- Centrifuges,
- Elevators and cranes,
- Paper and rolling-mill drives,
- Cross cutters and shears,
- Conveyor belts,
- Presses,
- Cable winches.

#### Worldwide application

SINAMICS S150 drive converter cabinet units are manufactured in compliance with relevant international standards and directives, and are therefore suitable for worldwide use (see technical data).

# SINAMICS S150

## Drive converter cabinet units 75 kW to 1200 kW

### System overview

#### Design

The SINAMICS S150 drive converter cabinet units are characterized by their compact, modular and service-friendly design

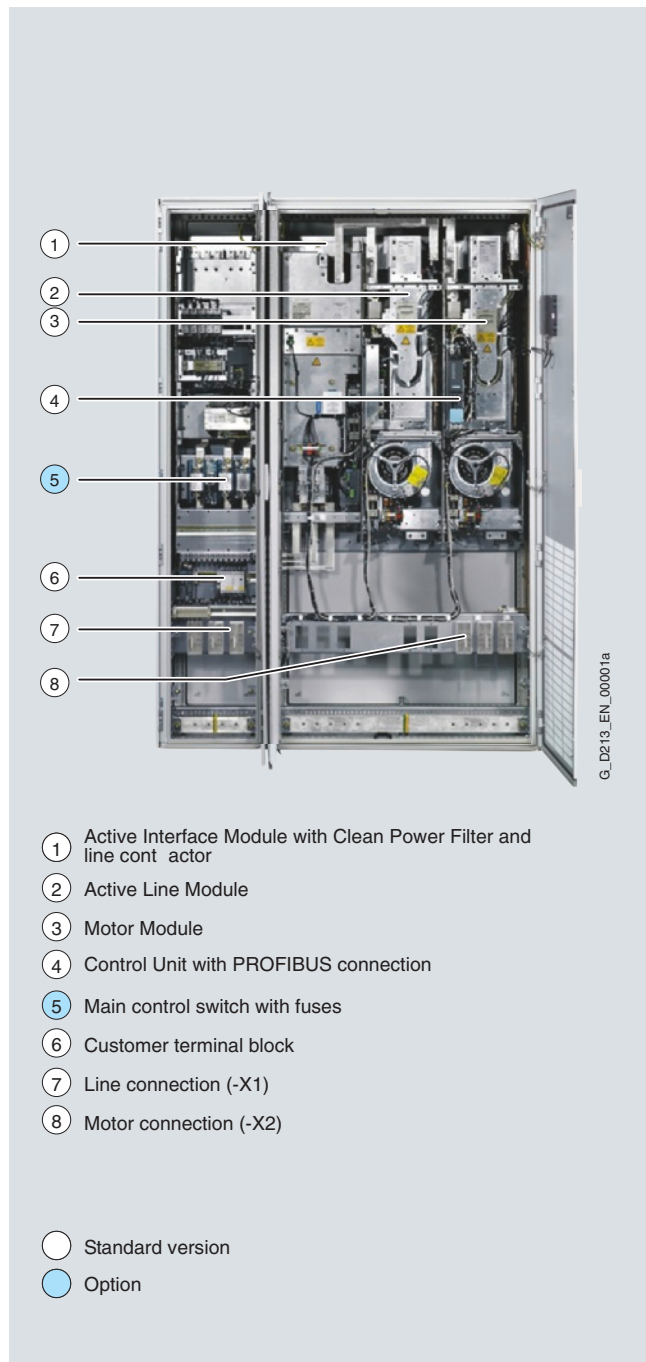

Example of the design of a SINAMICS S150 drive converter cabinet unit

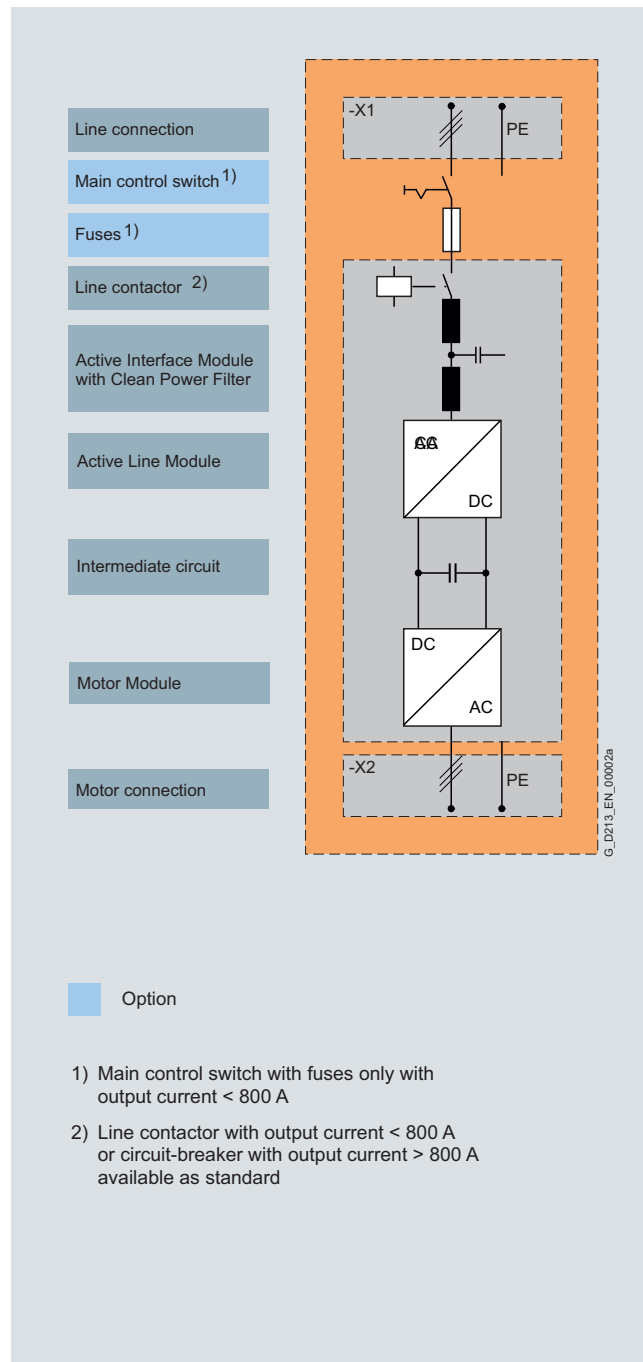

Basic design of a SINAMICS S150 drive converter cabinet unit with a number of version-specific options

#### More info

[www.siemens.com/sinamics-s150](http://www.siemens.com/sinamics-s150)

Catalog: PM 21.3, chapter 4



# CNC automation system SINUMERIK

## Safety Integrated for SINUMERIK 840D and SINUMERIK 840D sl

### Overview



#### *SINUMERIK 840D sl with SINAMICS S120*

The SINUMERIK 840D sl offers modularity, open architecture, flexibility, uniform structure for operation, programming and visualization and provides a system platform with future-oriented functions for virtually every technology. Integrated into the SINAMICS S120 drive system and complemented by the SIMATIC S7-300 automation system, the SINUMERIK 840D sl forms a new complete digital system that is ideally suited for the mid to upper performance range. The SINUMERIK 840D sl is characterized by its flexibility, excellent dynamics, precision, and optimum integration in networks.

The SINUMERIK 840D sl combines CNC, HMI, PLC, closed-loop control and communication tasks on one SINUMERIK NCU (NCU 710.2/NCU 720.2/NCU 720.2 PN/NCU 730.2/NCU 730.2 PN). Up to 6 axes are available on the SINUMERIK 840D sl with NCU 710.2. On the NCU 720.2/NCU 720.2 PN/NCU 730.2 and NCU 730.2 PN, the number of axes and/or the performance of the drive control can be increased to 31 axes.

SINAMICS S120 can be used to solve complex drive tasks for a very wide spectrum of industrial applications and is consequently designed as a modular system toolbox. From a wide range of matched components and functions, the user selects just the combination that best suits his own particular requirements. All SINUMERIK 840D sl and SINAMICS S120 components, including the motors and encoders, are interconnected via a joint serial interface called DRIVE-CLiQ.

#### *SINUMERIK 840D with SIMODRIVE 611 digital*

The SINUMERIK 840D is a CNC for up to 31 axes. It is designed to form an integral component of the modular SIMODRIVE 611 digital converter system and is thus capable of communicating with lines of drive modules via the shortest possible route.

SIMODRIVE 611 digital is a flexibly configurable converter system that is economically and ecologically designed to meet the technical demands made on modern machines. With SIMODRIVE 611 digital, Siemens is offering a converter system with digital closed-loop controls which meets the highest demands in terms of dynamic response, speed setting range, and smooth running characteristics.

The converter system's modular design makes it possible to configure drive systems with a virtually unlimited number of axes or main spindles.

#### *Motors*

The SINAMICS S120 and SIMODRIVE 611 drive systems are enhanced by a wide range of synchronous and asynchronous motors.

#### *Safety functions*

The safety-relevant functions of the SINUMERIK 840D sl/840D are integrated in the four subsystems NC, PLC, speed controller and drive. The safety-oriented functions are of two-channel design; data cross-checks are performed between the two channels.

### Application

SINUMERIK 840D sl is used worldwide:

- Turning, drilling, milling, grinding, laser machining, nibbling and punching technologies
- Tool and mold making
- Press control
- High-speed cutting
- Woodworking and glass processing
- Handling
- Transfer lines
- Rotary indexing machines
- Large-scale and jobshop production

The SINUMERIK is available as an export version for use in countries where approval is required.

<http://www.siemens.com/sinumerik>

#### *SINUMERIK Safety Integrated*

SINUMERIK Safety Integrated provides integrated safety functions that support the implementation of highly effective personnel and machine protection. The safety functions comply with the requirements of Category 3, as well as Performance Level PL d according to EN ISO 13849 and safety integrity level SIL 2 of DIN EN 61508. Consequently, important functional safety requirements can be implemented easily and economically. Available functions include, among others:

- Functions for safe monitoring of velocity and standstill
- Functions for establishing safe boundaries around working areas and protection zones, and for range recognition
- Direct connection of all safety-relevant signals and their internal logical linkage

#### *Type examination certificates/test certificates*

The following are available for the SINUMERIK 840D und SINUMERIK 840D sl:

- Type Examination Certificate of the BGIA (EN ISO 13849/EN 61508)
- Certificate of TÜV Rheinland (ISO 13849/IEC 61508)
- Certificate of TÜV Rheinland North America (NFPA 79/IEC 61508)

A list of the certified software releases and hardware versions is provided with each Certificate of Licence (CoL) of the SINUMERIK Safety Integrated option.

The Safety Integrated functions of the SINUMERIK are usually certified by independent institutes. A current list of components that have already been certified can be requested from your local Siemens office.

If you have any questions relating to certifications that have not yet been completed, please contact your local Siemens office.

Downloads are available under the following links:

For SINUMERIK 840D sl:  
<http://support.automation.siemens.com/WW/view/en/28369234/134200>

For SINUMERIK 840D:  
<http://support.automation.siemens.com/WW/view/en/28368460/134200>

### More information

Additional information is available in the Internet under:

[www.siemens.com/sinumerik](http://www.siemens.com/sinumerik)

# CNC automation system SINUMERIK

## Safety Integrated for SINUMERIK 840D and SINUMERIK 840D sl

### Benefits

- High safety standards:  
Complete implementation of the safety functions in Category 3 / SIL 2 / PL d
- High level of flexibility:  
Supports the implementation of practicable safety and operating concepts
- Extremely cost-effective:  
Reduced hardware and installation costs
- High degree of availability:  
Absence of interference-susceptible electromechanical switching elements

### Application

SINUMERIK Safety Integrated is used in the machine tool environment to implement functional safety. This includes, for example, safely monitoring speed/velocity and/or zero speed in the appropriate operating situations.

#### Application example 1

Working with the protective door open – the axis/spindle must not move:

The operator carries-out - for example – the following:

- checks
- measures
- cleans
- aligns
- removes chips
- changes the workpiece
- changes the tool

Protective functions that are effective:

1. Protection against unexpected starting using the safe standstill function – the drive pulses are safely cancelled
2. The standstill position is monitored using the safe operating stop – the drives remain in safe closed-loop position control for
  - vertical axes
  - non-symmetrical workpieces in the spindle
  - axes with no friction

#### Application example 2:

Working with the protective door open – the axis/spindle is to be moved:

The operator carries-out - for example - the following:

- moves the axes using the jog keys
- rotates the spindle (using the agreement button)
- tests programs (using the agreement button)
- executes measuring cycles

Protective functions that are effective:

1. Protection against unexpectedly high speeds – using the safely-reduced speed function
2. Protection against inadmissible process quantities – using the safely-reduced speed function:
  - burst protection for grinding wheels
  - max. spindle speed as a function of the chuck being used

### Function

The safety functions are available in all of the operating modes and can communicate with the process via safety-relevant input/output signals. They can be implemented for every axis and spindle:

#### • Safe Stopping Process

The various stop responses, configured by the user, optimally bring the drives to a standstill when a monitoring function or a sensor responds (e.g. light curtain).

The drives are safely shutdown optimally adapted to the particular operating state of the machine.

#### • Safe operating stop (SBH)

The safe operating stop is used to monitor the position of an axis or spindle when it is at a standstill. The drives remain fully functional in the closed-loop position or speed controlled mode. When the monitoring function is active – and for example, in the setting-up mode – safety zones (e.g. the tool magazine) can be entered without having to shut down the drives.

#### • Safe standstill (SH)

This function safely disconnects the power fed to the motor when a fault condition develops or in conjunction with a machine function (e.g., Emergency Stop). This is realized electronically for each individual axis. The basis for this function is the safe pulse cancellation integrated in the drive. The pulses are cancelled through two channels in the drive module. This means that the motor can no longer accidentally start – and additional external hardware circuits to implement Emergency Stop functions can be eliminated.

#### • Safety-reduced speed (SG)

Configurable speed limits are monitored – for instance when setting-up a machine without using an agreement button. In this case, the actual drive speed on the load side is compared with the selected speed limit. Up to 34 speed limits can be defined for each drive so that different applications and operating states at the machine can be monitored.

#### • Safe software limit switches (SE)

Working/ protective zones can be demarcated and traversing ranges limited on an axis-for-axis basis using the safe software limit switches. Two safe software limit switch pairs are available for each axis. Hardware limit switches for the axis end stops and their time consuming mounting, adjustment and wiring can all be eliminated.

#### • Safe software cams (SN)

The safe software cam function can be used to implement a safety-relevant traversing range detection on an axis-for-axis basis - therefore replacing today's "hardware solution". SINUMERIK 840D supports 4 cam pairs for each axis and SINUMERIK 840D sl 30 cam pairs for each axis.

#### • Safety-relevant input/output signals (SGE/SGA)

The safety-relevant input and output signals are used as an interface to the process. These are digital signals that the system can either send or receive.

#### • Safe programmable logic (SPL)

Safety-related sensors and actuators can be directly connected to the safety-relevant I/O of the control system when using safe programmable logic. External evaluation units are not required and signals are safely evaluated in the software. The associated logic operations are redundantly implemented in the NC and in the integrated PLC.

#### • Safe brake management (SBM)

The safe brake management function comprises a safe braking signal and a cyclic braking test. The safely controlled and tested brake in conjunction with the safely-monitored drive results in a redundant holding system to prevent vertical axes falling. The reliability of a mechanical brake is an essential component when it comes to providing protection against vertical axes falling. The brakes that are generally used today are not safety-relevant components. A safe brake function is obtained by integrating the standard brake (a component that has been well-proven in the field) into the safety concept of SINUMERIK Safety Integrated.

# CNC automation system SINUMERIK

## Safety Integrated for SINUMERIK 840D and SINUMERIK 840D sl

The brake is safely and electrically controlled in accordance with Category 3 (EN 954-1). It is controlled through two channels, P/M-switching (Plus/Minus). The safe brake test cyclically checks whether the expected holding torque is generated. Faults and errors in the control and in the mechanical braking system can be identified using these extended test procedures.

### • Safety-related communications via a standard bus

The safety-relevant sensors and actuators can be directly connected via the fail-safe SIMATIC PROFI-safe I/O - ET 200S, ET 200pro and ET 200eco or DP/AS-i F-Link.. This distributed I/O is connected through the standard PROFIBUS fieldbus with the PROFI-safe profile.

The SINUMERIK 840D sl ensures reliable communication via PROFIBUS or PROFINET between several fail-safe controllers. This means that safe signals can be exchanged, for example at transfer lines, between the individual machines and a central master controller.

### • Integrated acceptance test

When a machine is commissioned all of the safety-relevant functions of the electric drives must be tested in the form of an acceptance test. The test results must then be appropriately documented. This procedure applies to all electric drives no matter whether the safety functions are integrated in the controls and drives or whether external monitoring devices and equipment are used. This integrated acceptance test provides the OEM with a tool that he can use to semi-automatically carry-out this test with operator prompting. In addition to saving valuable time, this tool stands out as a result of its prompted test procedure and the fact that trace functions can be automatically configured. The automatically generated acceptance report proves the quality of the functional safety of the machine – both for the OEM as well as for the company that actually operates the machine.

## Integration

### Requirements for SINUMERIK 840D:

- General
  - SINUMERIK 840D
  - SIMODRIVE 611 digital with High-Performance control module or High-Standard control module with additional DMS input
  - The measuring circuit cables must comply with the SIMODRIVE 611 digital specifications
- For the integrated acceptance test
  - SinuCom NC software tool (can run on PC/PG)
  - SINUMERIK software version from 6.4.15
- Sensor/actuator integration with PROFI-safe I/Os
  - SINUMERIK 840D with NCU 57x.4 or NCU 57x.5
  - SINUMERIK software version from 6.3
  - Software option I/O interface via PROFIBUS DP
  - SIMATIC ET 200S or
  - SIMATIC ET 200eco or
  - SIMATIC ET 200pro or
  - DP/AS-i F-Link
  - S7 F Configuration Pack software module
- Encoder systems
 

For information on suitable encoder systems for SINUMERIK Safety Integrated, please contact your local Siemens branch.
- S7 F Configuration Pack software module
- Software options in accordance with "Selection and Ordering Data"
  - With software version 7 and above, the SI Basic option can be ordered for machines for which 4 inputs/outputs are sufficient for safe programmable logic.
  - When more than 4 inputs/outputs are required for safe programmable logic, the SI Comfort option must be used.
  - When the Safe programmable logic function is not used with Safety Integrated, the SI Basic option is adequate.

### Requirements for SINUMERIK 840D sl:

- General
  - SINUMERIK 840D sl (NCU 710.2/NCU 720.2/NCU 730.2/NCU 730.2 PN)
  - SINAMICS S120 booksize format
  - The measuring circuit cables must comply with the SINAMICS S120 specification.
- For the integrated acceptance test
  - SinuCom NC software tool (can run on PC/PG)
- Sensor/actuator integration with PROFI-safe I/Os
- Fail-safe modules
  - SIMATIC ET 200S or
  - SIMATIC ET 200eco or
  - SIMATIC ET 200pro or
  - DP/AS-i F-Link
- Encoder systems
 

For information on suitable encoder systems for SINUMERIK Safety Integrated, please contact your local Siemens branch.
- S7 F Configuration Pack software module

### Selection and ordering data

	Order No.
<b>SINUMERIK Safety Integrated for SINUMERIK 840D</b> (from software version 7)	
• SI Basic (for 1 axis/spindle; up to 4 inputs and 4 outputs can be used for the safe programmable logic)	<b>6FC5250-0AG00-0AA0</b>
• SI Comfort (for 1 axis/spindle; up to 64 inputs and 64 outputs can be used for the safe programmable logic)	<b>6FC5250-0AG10-0AA0</b>
• SI axis/spindle (per axis/spindle with 2 or more axes/spindles)	<b>6FC5250-0AG11-0AA0</b>
• SI axis/spindle package (additional 15 axes/spindles)	<b>6FC5250-0AG12-0AA0</b>

	Order No.
<b>SINUMERIK Safety Integrated for SINUMERIK 840D sl</b>	
• SI Basic (incl. 1 axis/spindle; up to 4 inputs and 4 outputs can be used for the safe programmable logic)	<b>6FC5800-0AM63-0YB0</b>
• SI Comfort (for 1 axis/spindle; up to 64 inputs and 64 outputs can be used for the safe programmable logic)	<b>6FC5800-0AM64-0YB0</b>
• SI axis/spindle (extra for each additional axis/spindle)	<b>6FC5800-0AC70-0YB0</b>
• SI axis/spindle package (additional 15 axes/spindles)	<b>6FC5800-0AC60-0YB0</b>

# CNC automation system SINUMERIK

## Safety Integrated for SINUMERIK 828D

### Overview



With the SINUMERIK 828D, Siemens offers a "Safety Integrated" solution for the midrange market. It matches all requirements defined in the machinery directive, as well as applicable standards. Many job-shop companies, which use smaller standalone machines to produce high-volume goods, prefer compact programmable machine tools.

The SINUMERIK 828D is a panel-based CNC control for demanding applications running on lathes and mills, typically located in work shops. It combines CNC, PLC, HMI and axis controlling functions in one sturdy unit. The safety-relevant functions of the SINUMERIK 828D are implemented on the basis of the safety functions of the drive system SINAMICS S120.

Drive Based Safety Integrated provides integrated safety functions that support the implementation of highly effective personnel and machine protection. The safety functions comply with the requirements of Category 3 as well as Performance Level PL d according to EN ISO 13849-1 and safety integrity level SIL 2 according to EN 61508. Consequently, important functional safety requirements can be implemented easily and economically. The range of functions includes, for example:

- Functions for safe monitoring of standstill
- Functions for safe monitoring of speed

### Benefits

- High level of safety:  
Full implementation of the safety functions in Category 3/SIL 2/PL d
- High level of flexibility:  
Practical safety and operating concepts can be implemented
- Faster commissioning using integrated safety functions

### Function

The safety functions are available in all modes and can communicate with the process using safety-oriented input/output signals. These can be implemented individually for each axis and spindle. The following Safety Integrated functions are available (terms in accordance with IEC 61800-5-2):

#### Safety Integrated basic functions

- Safe Torque Off (STO)  
Prevention of unexpected startup by internal cancellation of the drive pulses.

- Safe Brake Control (SBC)  
Safe brake control of holding brakes which are operative at zero current, e.g. motor holding brakes.
- Safe Stop 1 (SS1)  
Safe stopping of the drive with subsequent prevention of unexpected startup (STO).

#### Extended Safety Integrated functions

- Safe Operating Stop (SOS)  
Monitors drives for standstill. The drives remain fully functional for position control.
- Safe Stop 2 (SS2)  
Safe stopping of the drive with subsequent monitoring for standstill (SOS).
- Safely Limited Speed (SLS)  
Monitoring of configurable velocity limit values, e.g. during setup.
- Safe Speed Monitor (SSM)  
Safe checkback signal when a value falls below a settable speed limit, e.g. for enabling a protective door.
- Safe Acceleration Monitor (SAM)  
Prompt detection of a new axis acceleration during braking (SS1 and SS2).

The Safety Integrated basic functions are license-free. The Extended Safety Integrated functions require a software license in the form of a CNC option per axis with Safety functions.

The Safety Integrated basic functions are controlled via existing terminals on the SINAMICS S120 Combi Power Modules or the SINAMICS S120 Motor Modules in booksize compact format and the SINUMERIK 828D BASIC T/BASIC M. A TM54F Terminal Module is required to control the Extended Safety Integrated functions.

For the formation of the safe control logic, fail-safe 3TK28 or 3RK3 safety relays are recommended.

See the Siemens Industry Mall: [www.siemens.com/industrymall](http://www.siemens.com/industrymall)

### Integration

SINUMERIK 828D BASIC T

- SINUMERIK 828D BASIC M
- SINUMERIK 828D
- SINAMICS S120 Combi Power Module or SINAMICS S120 Motor Module in booksize compact format
- Motors with encoders which comply with the Safety Integrated specification: 1PH8 or 1FK7 motors
- Encoder systems  
For information on suitable encoder systems for SINUMERIK Safety Integrated, please contact your local Siemens branch.
- Signal cables which comply with the SINAMICS S120 specification: MOTION-CONNECT
- Control of the Extended Safety Integrated functions: TM54F Terminal Module
- CNC software license required per axis for the Extended Safety functions see SINUMERIK 828D BASIC
- 3TK28 or 3RK3 safety relays

### Selection and ordering data

	Order No.
<b>SINUMERIK Safety Integrated for SINUMERIK 828D</b>	
• Safety Integrated Extended Functions for one CNC axis	<b>6FC5800-0AC50-0AA0</b>

# Appendix



5/2	<b>Standard B10 values of electrical and mechanical components</b>
5/4	<b>Training</b>
5/6	<b>Siemens contact partners</b>
5/7	<b>Information and ordering in the Internet and on DVD</b>
5/9	<b>Service &amp; Support</b>
5/12	<b>Siemens Solution Partners</b>
5/13	<b>Subject index</b>
5/16	<b>Order number index</b>
5/29	<b>Software licenses</b>
5/30	<b>Conditions of sale and delivery / Export regulations</b>

# Appendix

## Standard B10 values of electrical and mechanical components

### Safety characteristics

In the following standards, the so-called B10 values for calculating the safety integrity or safety integrity level (SIL) in functional safety at a high or continuous demand rate are required also for electromechanical switchgear:

- IEC 62061 "Safety of machines - Functional safety of safety-related electrical, electronic and programmable electronic control systems",
- ISO 13849-1 "Safety of machines - Safety-related components of controls - Part 1: General principles".

Failure rates of electromechanical components are required for calculating the safety integrity or safety integrity level (SIL) in functional safety:

- in the manufacturing industry at a high demand rate
- in the process industry at a low demand rate

Further requirements are laid down in IEC 61511-1 "Functional safety - Safety instrumented systems for the process industry sector - Part 1: Framework, definitions, system, hardware and software requirements".

The TÜV-tested Safety Evaluation Tool assists in calculating the safety function as verification for the machine documentation. It is available on the Internet at

[www.siemens.com/safety-evaluation-tool](http://www.siemens.com/safety-evaluation-tool).

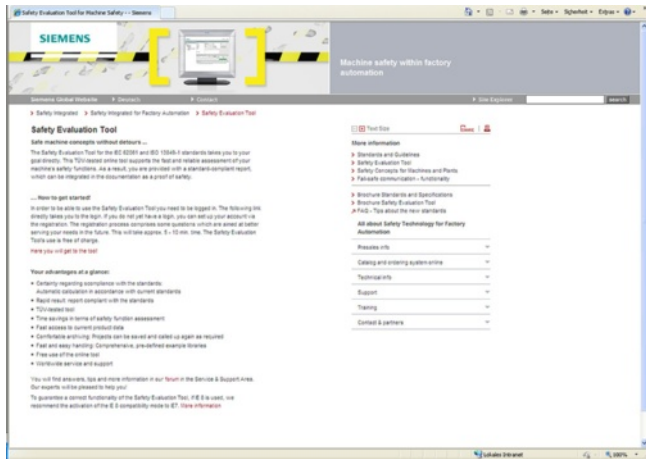

At [www.siemens.com/safety-integrated](http://www.siemens.com/safety-integrated) you will also find functional examples with calculations according to the current standards.

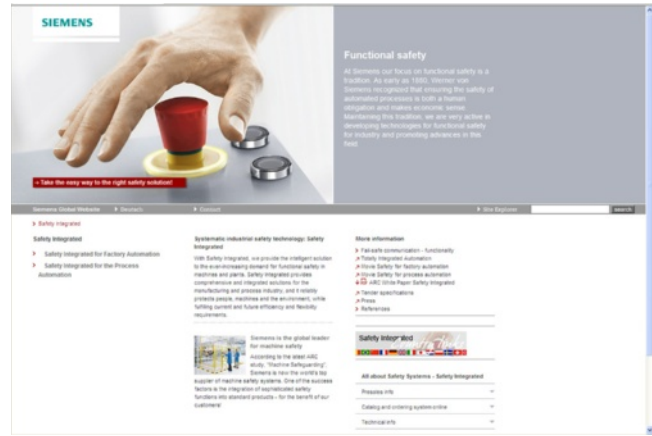

### Definitions

$\lambda(t) dt$  is the probability that a unit which has not failed by a certain time  $t$  will fail in the following interval  $(t; t + dt)$ . Failure rates have the dimension 1/time unit, e.g. 1/h. Failure rates for components are often specified in FIT (failures in time unit): 1 FIT equals  $10^{-9}/h$ . From the failure rate it is possible to derive a (mathematical) distribution function of the failure probability:

$$F(t) = 1 - \exp(-\lambda t), \text{ with } \lambda \text{ as constant failure rate}$$

- The mean value of this exponential distribution is also referred to as:
  - Mean Time To Failure (MTTF) in the case of irreparable components; 63.2 % of components fail by the MTTF.
  - Mean Operating Time Between Failures (MTBF) in the case of repairable components.
- $MTTF = 1/\lambda$ . (MTTF is a statistical mean value but no guarantee for endurance)

Electromechanical components are often irreparable components. In general, the failure rate of monitored units changes with age.

The B10 value for devices subject to wear is expressed in number of operating cycles:

- it is the number of operating cycles after which 10 % of the test specimens fail in the course of an endurance test (or: the number of operating cycles after which 10 % of the devices have failed).

For low demand rates (mainly in the process industry), the failure rate and not the B10 value is used to determine the failure probability.

### Standard B10 values at a high demand rate

With the help of the B10 value and a simplified formula (see section 6.7.8.2.1 of EN 62061), the user can then calculate the total failure rate of an electromechanical component:

$$\lambda = 0.1 \times C/B10$$

with C = operating cycles per hour. C is specified by the user.

The failure rate is made up of safe ( $\lambda_S$ ) and dangerous ( $\lambda_D$ ) failures:

$$\lambda = \lambda_S + \lambda_D$$

or

$$\lambda_D = [\text{share of dangerous failures in \%}] \times \lambda$$

$$\lambda_S = [\text{share of safe failures in \%}] \times \lambda$$

The failure rate of the dangerous failures  $\lambda_D$  of the components used is needed for further calculations.

Listed in the following table are the standard B10 values and the share of dangerous failures for SIRIUS product groups at a high demand rate.

Standard B10 values (at a high demand rate)		
SIRIUS product group (electromechanical components)	Standard B10 value (operating cycles)	Share of dangerous failures
EMERGENCY-STOP control devices (with positive-opening contacts)		
- Pulled to unlatch	30 000	20 %
- Rotated to unlatch (also with lock)	100 000	20 %
Cable-operated switches for EMERGENCY-STOP function (with positive-opening contacts)	1 000 000	20 %
Standard position switches (with positive-opening contacts)	10 000 000	20 %
Position switches with separate actuator (with positive-opening contacts)	1 000 000	20 %
Position switches with solenoid interlock (with positive-opening contacts)	1 000 000	20 %
Hinge switches (with positive-opening contacts)	1 000 000	20 %
Pushbuttons (non-latching), with positive-opening contacts)	10 000 000	20 %
Contactors / motor starters (with positively driven contacts in the case of 3RH/3TH and mirror contacts in the case of 3RT/3TF)	1 000 000	73 %

The  $B_{10d}$  value used in EN ISO 13849-1:2008 is determined as follows:

$$B_{10d} = \frac{B_{10}}{\text{Share of dangerous failures}}$$

## Standard B10 values of electrical and mechanical components

### Calculation example

A protective door is monitored by a position switch with a separate actuator.

The protective door is opened 4 times an hour.

The overall failure rate of the position switch is:

$$\lambda = 0.1 \cdot C/B_{10} \text{ [failures/h]}$$

$$\lambda = 0.1 \cdot 4/1\,000\,000 = 4 \cdot 10^{-7} \text{ [failures/h]}$$

The dangerous failure rate is calculated with:

$$\lambda_D = 20 \% \text{ of } \lambda = 0.2 \cdot 4 \cdot 10^{-7} \text{ [failures/h]}$$

$$\lambda_D = 8 \cdot 10^{-8} \text{ [failures/h]}$$

### Standard failure rates (at a low demand rate)

On the basis of the failure rates it is possible to calculate the average probability of failure on demand ( $PFD_{avg}$ ) of a PLT protective device.

A so-called low demand rate is assumed, meaning the rate of demand on the safety-related system amounts to no more than once a year and is not greater than double the frequency of the repeat test.

A repeat test once a year is recommended for electromechanical components in order to reveal passive faults.

For special applications it is possible, in agreement with the inspecting institution (e.g. a technical inspectorate, government agency or the like) to extend the test intervals by using suitable solutions (e.g. a multi-channel version etc.).

Under the above conditions and in compliance with the requirements laid down in IEC 61511 it is possible to achieve SIL 2 with a single-channel design and SIL 3 with a two-channel design.

Listed in the following table are the standard failure rates and the share of dangerous failures for SIRIUS product groups at a low demand rate.

Standard failure rates at a low demand rate		
SIRIUS product group (electromechanical components)	Standard failure rates (in FIT) <sup>1)</sup>	Share of dangerous failures <sup>2)</sup>
EMERGENCY-STOP control devices (with positive-opening contacts)	100	20 %
Cable-operated switches for EMERGENCY-STOP function (with positive-opening contacts)	100	20 %
Standard position switches (with positive-opening contacts)	100	20 %
Position switches with separate actuator (with positive-opening contacts)	100	20 %
Position switches with solenoid interlock (with positive-opening contacts)	100	20 %
Hinge switches (with positive-opening contacts)	100	20 %
Pushbuttons (non-latching) (with positive-opening contacts)	100	20 %
Contactors / motor starters (with positively driven contacts in the case of 3RH/3TH and mirror contacts in the case of 3RT/3TF)	100	< 40 %

<sup>1)</sup> The failure rates specified in the table were limited to 100 FIT.

<sup>2)</sup> Valid only under the previously mentioned conditions.

<sup>3)</sup>

Siemens standard SN 31920 contains more detailed explanations.

# Appendix Training

## Training

### Faster and more applicable know-how: Hands-on training from the manufacturer

**SITRAIN®** – the Siemens Training for Automation and Industrial Solutions – provides you with comprehensive support in solving your tasks.

Training by the market leader in automation and plant engineering enables you to make independent decisions with confidence. Especially where the optimum and efficient use of products and plants are concerned. You can eliminate deficiencies in existing plants, and exclude expensive faulty planning right from the beginning.



First-class know-how directly pays for itself: In shorter startup times, high-quality end products, faster troubleshooting and reduced downtimes. In other words, increased profits and lower costs.

#### Achieve more with SITRAIN

- Shorter times for startup, maintenance and servicing
- Optimized production operations
- Reliable configuration and startup
- Minimization of plant downtimes
- Flexible plant adaptation to market requirements
- Compliance with quality standards in production
- Increased employee satisfaction and motivation
- Shorter familiarization times following changes in technology and staff

#### Contact

Visit our site on the Internet at:

<http://www.siemens.com/sitrain>

or let us advise you personally.

#### SITRAIN Customer Support Germany:

Phone: +49 (0) 911 / 895 7575

Fax: +49 (0) 911 / 895 7576

E-Mail: [info@sitrain.com](mailto:info@sitrain.com)

### SITRAIN highlights

#### Top trainers

Our trainers are skilled teachers with direct practical experience. Course developers have close contact with product development, and directly pass on their knowledge to the trainers.

#### Practical experience

The practical experience of our trainers enables them to teach theory effectively. But since theory can be pretty drab, we attach great importance to practical exercises which can comprise up to half of the course time. You can therefore immediately implement your new knowledge in practice. We train you on state-of-the-art methodically/didactically designed training equipment. This training approach will give you all the confidence you need.

#### Wide variety

With a total of about 300 local attendance courses, we train the complete range of Siemens Industry products as well as interaction of the products in systems.

#### Tailor-made training

We are only a short distance away. You can find us at more than 50 locations in Germany, and in 62 countries worldwide. You wish to have individual training instead of one of our 300 courses? Our solution: We will provide a program tailored exactly to your personal requirements. Training can be carried out in our Training Centers or at your company.

#### The right mixture: Blended learning

"Blended learning" means a combination of various training media and sequences. For example, a local attendance course in a Training Center can be optimally supplemented by a teach-yourself program as preparation or follow-up. Additional effect: Reduced traveling costs and periods of absence.





## SITRAIN course offer for "Safety Integrated"

Title	Target group							Duration	Short title
	Decision makers, sales personnel	Project managers, project team members	Programmers	Commissioning engineers, configuration	Service personnel	Operators, users	Maintenance personnel		
<b>Factory automation</b>									
European safety standards for functional safety in practice	✓	✓	✓	✓				1 day	ST-NSSTPRX
Current European directives and CE standards in machinery and plant environments	✓	✓	✓	✓				1 day	ST-CEKEN
<b>Process automation</b>									
SIMATIC PCS 7-Process Safety		✓	✓	✓				3 days	ST-PCS7SAF
IEC 61511 Functional safety in the process industry	✓	✓		✓				2 days	ST-NRM
IEC 61511 Practical use	✓	✓		✓				1 day	ST-NRMPRX
<b>Drives (AC-Converter)</b>									
SINAMICS S120 Safety Integrated		✓	✓	✓				2 days	DR-SNS-SAF
<b>Industry automation systems SIMATIC (SIMATIC S7 H/F-Safety Integrated)</b>									
Design and programming of safety related SIMATIC S7 controller via Distributed Safety			✓	✓				3 days	ST-PPDS
Projecting and programming of the fault tolerance SIMATIC S7-400H controller			✓	✓				3 days	ST-7H400H
Projecting and programming of failsafe / fault tolerance SIMATIC S7-400H controller with the software F-Systems			✓	✓				3 days	ST-PPFS
<b>CNC automation system SINUMERIK</b>									
SINUMERIK 840D power line, Safety Integrated Maintenance Course					✓		✓	3 days	NC-84DSIS
SINUMERIK 840D power line, Safety Integrated Configuring and Start-Up				✓	✓			5 days	NC-84DSIW
SINUMERIK 840D sl, Safety Integrated Maintenance Course					✓		✓	3 days	NC-84SLSIS
SINUMERIK 840D sl Safety Integrated Configuring and Start-up				✓	✓			5 days	NC-84SLSIW

For more detailed information on these and other courses on "Safety Integrated" please go to

[www.siemens.com/sitrain-safetyintegrated](http://www.siemens.com/sitrain-safetyintegrated)

# Appendix

## Partner at Industry Automation and Drive Technologies



At Siemens Industry Automation and Drive Technologies, more than 85 000 people are resolutely pursuing the same goal: long-term improvement of your competitive ability. We are committed to this goal. Thanks to our commitment, we continue to set new standards in automation and drive technology. In all industries – worldwide.

At your service locally, around the globe for consulting, sales, training, service, support, spare parts ... on the entire Industry Automation and Drive Technologies range.

Your personal contact can be found in our Contacts Database at: [www.siemens.com/automation/partner](http://www.siemens.com/automation/partner)

You start by selecting a

- Product group,
- Country,
- City,
- Service.

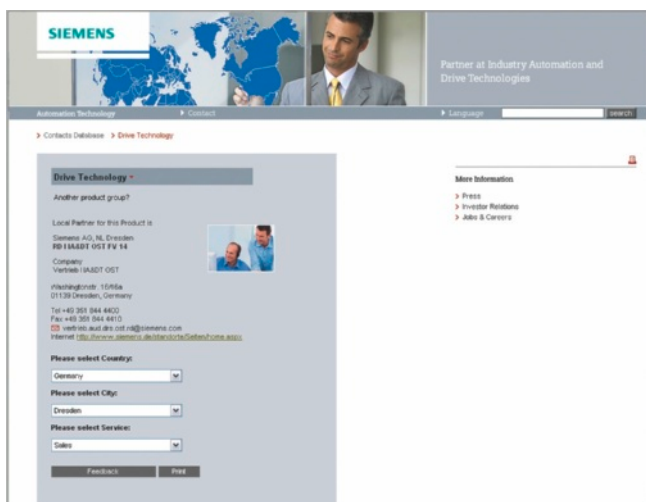
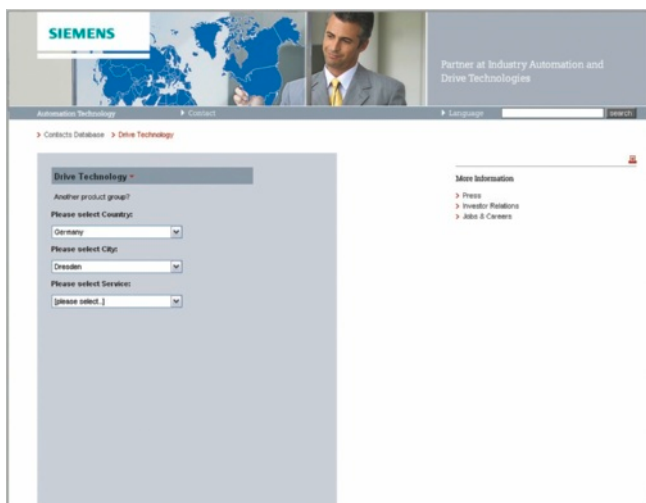

## Information and Ordering in the Internet and on DVD

### Siemens Industry Automation and Drive Technologies in the WWW



A detailed knowledge of the range of products and services available is essential when planning and configuring automation systems. It goes without saying that this information must always be fully up-to-date.

Siemens Industry Automation and Drive Technologies has therefore built up a comprehensive range of information in the World Wide Web, which offers quick and easy access to all data required.

Under the address

[www.siemens.com/industry](http://www.siemens.com/industry)

you will find everything you need to know about products, systems and services.

### Product Selection Using the Offline Mall of Industry

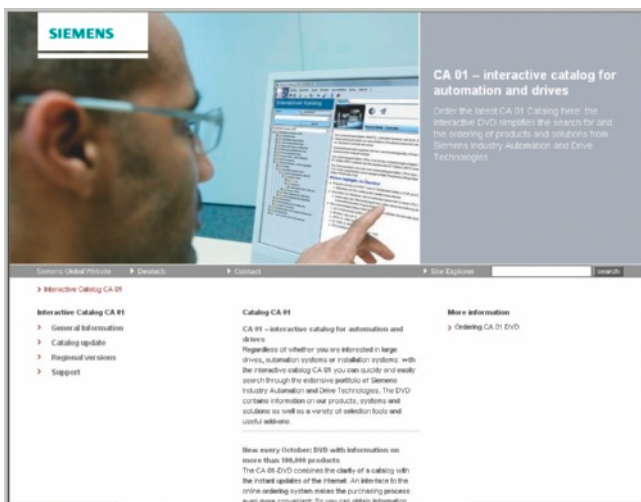

Detailed information together with convenient interactive functions:

The Offline Mall CA 01 covers more than 80 000 products and thus provides a full summary of the Siemens Industry Automation and Drive Technologies product base.

Here you will find everything that you need to solve tasks in the fields of automation, switchgear, installation and drives. All information is linked into a user interface which is easy to work with and intuitive.

After selecting the product of your choice you can order at the press of a button, by fax or by online link.

Information on the Offline Mall CA 01 can be found in the Internet under

[www.siemens.com/automation/ca01](http://www.siemens.com/automation/ca01)

or on DVD.

### Easy Shopping with the Industry Mall

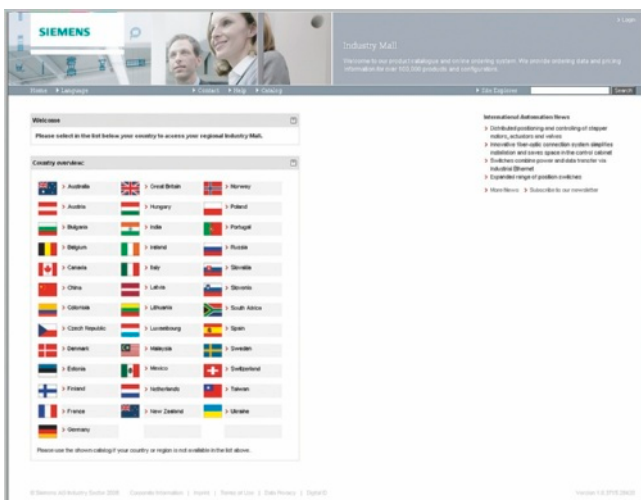

The Industry Mall is the virtual department store of Siemens AG in the Internet. Here you have access to a huge range of products presented in electronic catalogs in an informative and attractive way.

Data transfer via EDIFACT allows the whole procedure from selection through ordering to tracking of the order to be carried out online via the Internet.

Numerous functions are available to support you.

For example, powerful search functions make it easy to find the required products, which can be immediately checked for availability. Customer-specific discounts and preparation of quotes can be carried out online as well as order tracking and tracing.

Please visit the Industry Mall on the Internet under:

[www.siemens.com/industrymall](http://www.siemens.com/industrymall)

# Appendix Online Services

## Information and Ordering in the Internet and on DVD

### Safety Integrated in the WWW

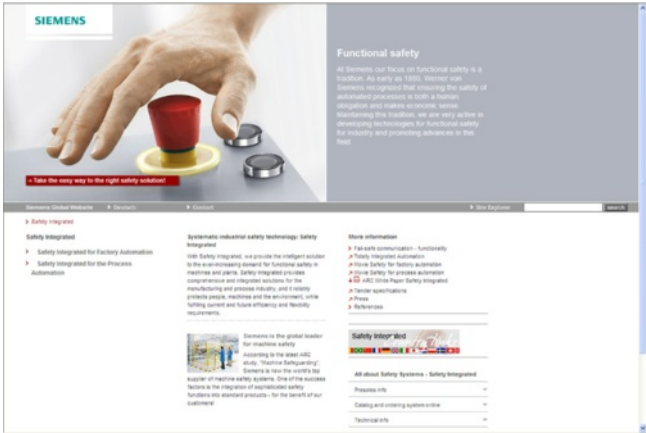

Safety Integrated offers comprehensive and integrated solutions for projects in the manufacturing and process industry. These solutions are accompanied by excellent services in all phases of a safety-related plant or machine. The website provides crucial information on products, solutions and support, for example manuals, references and function examples.

Under the address:

[www.siemens.com/safety-integrated](http://www.siemens.com/safety-integrated)

you will find all you need to know about products, systems and services.

### Easily download catalogs and information material

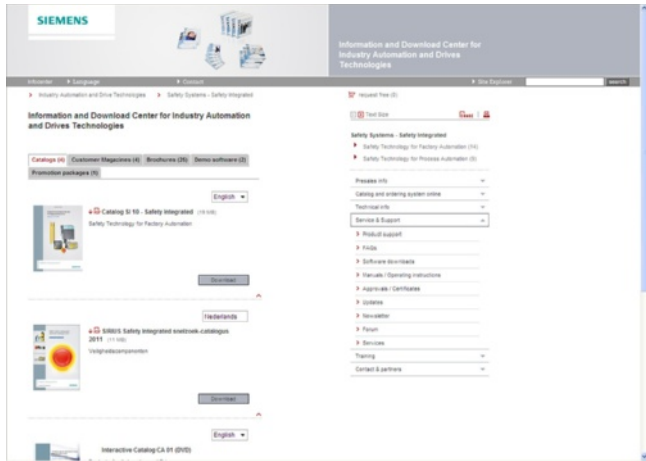

The Information and Download Center contains all current catalogs, customer magazines, brochures, demo software and action packs for downloading, or alternatively, for ordering. This also includes this catalog, the SI 10 "Safety Integrated".

[www.siemens.com/safety-infomaterial](http://www.siemens.com/safety-infomaterial)

### Newsletter Safety Integrated

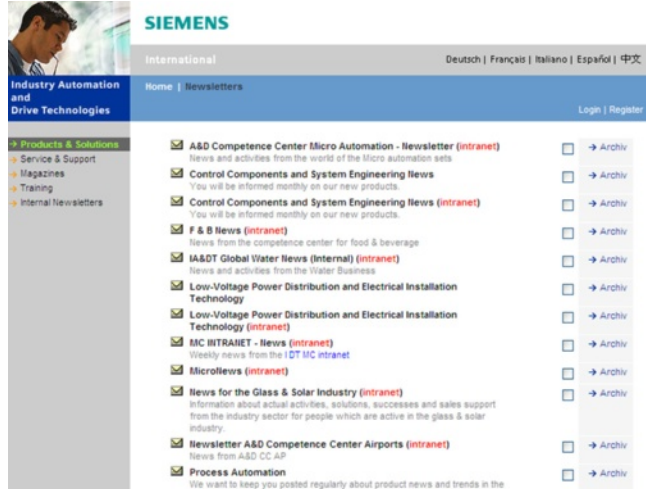

Our free Newsletter keeps you informed via e-mail about innovations, new products and product innovations and trends and also provides sample applications. With our Newsletter, you are always up-to-date.

Simply register under

[www.siemens.com/safety-integrated](http://www.siemens.com/safety-integrated)

Click into the linkbox "Presales info", then select "Newsletter".

5

The unmatched complete service for the entire life cycle

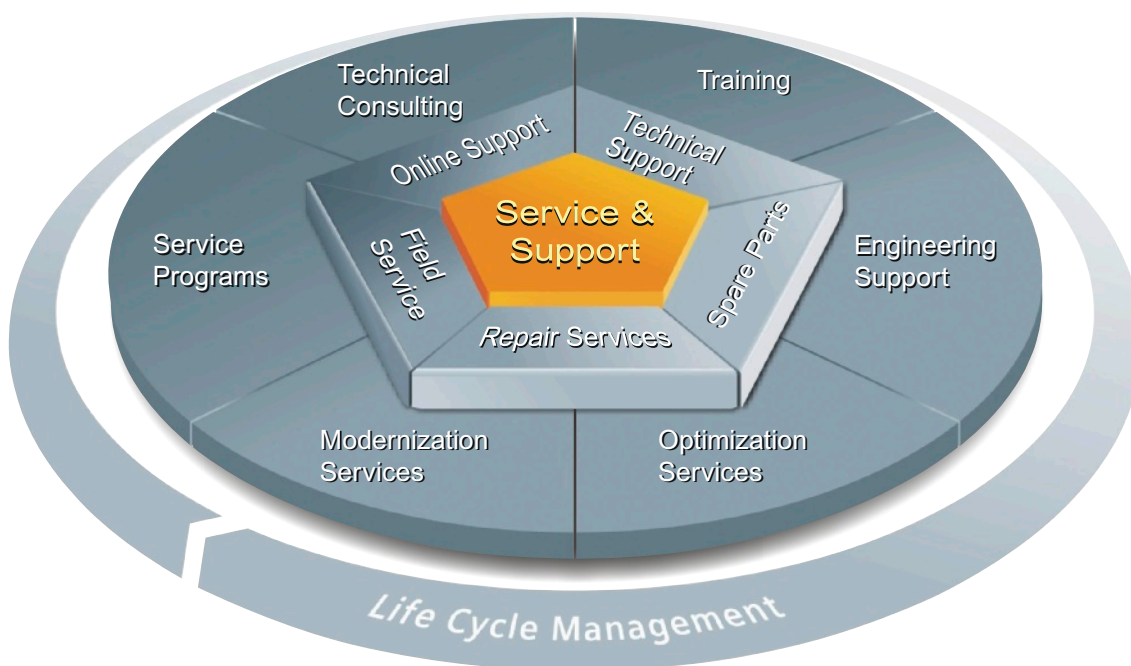

For machine constructors, solution providers and plant operators: The service offering from Siemens Industry, Automation and Drive Technologies includes comprehensive services for a wide range of different users in all sectors of the manufacturing and process industry

To accompany our products and systems, we offer integrated and structured services that provide valuable support in every phase of the life cycle of your machine or plant - from planning and implementation through commissioning as far as maintenance and modernization.

Our Service & Support accompanies you worldwide in all matters concerning automation and drives from Siemens. We provide direct on-site support in more than 100 countries through all phases of the life cycle of your machines and plants.

You have an experienced team of specialists at your side to provide active support and bundled know-how. Regular training courses and intensive contact among our employees - even across continents - ensure reliable service in the most diverse areas.

### Online Support

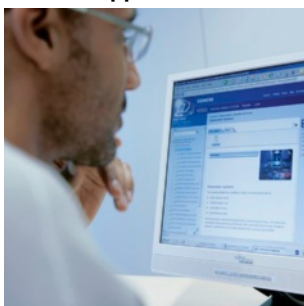

The comprehensive online information platform supports you in all aspects of our Service & Support at any time and from any location in the world.

[www.siemens.com/automation/service&support](http://www.siemens.com/automation/service&support)

### Technical Consulting

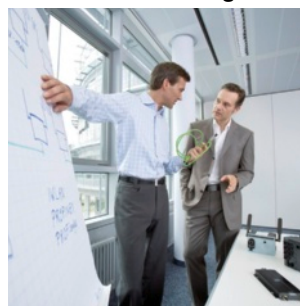

Support in planning and designing your project: From detailed actual-state analysis, definition of the goal and consulting on product and system questions right through to the creation of the automation solution.

### Technical Support

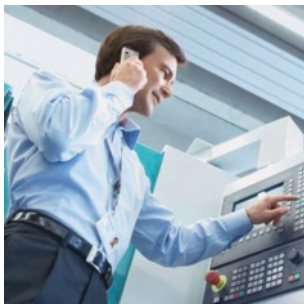

Expert advice on technical questions with a wide range of demand-optimized services for all our products and systems.

[www.siemens.com/automation/support-request](http://www.siemens.com/automation/support-request)

### Training

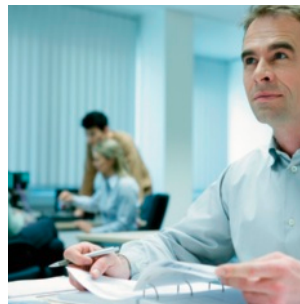

Extend your competitive edge - through practical know-how directly from the manufacturer.

[www.siemens.com/sitrain](http://www.siemens.com/sitrain)

Contact information is available in the Internet at:  
[www.siemens.com/automation/partner](http://www.siemens.com/automation/partner)

# Appendix

## Service & Support

The unmatched complete service for the entire life cycle

### Engineering Support

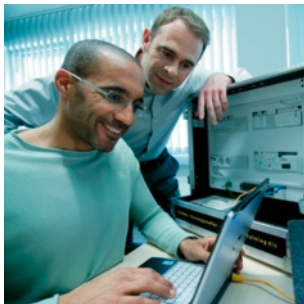

Support during project engineering and development with services fine-tuned to your requirements, from configuration through to implementation of an automation project.

### Modernization



You can also rely on our support when it comes to modernization - with comprehensive services from the planning phase all the way to commissioning.

### Field Service



Our Field Service offers you services for commissioning and maintenance - to ensure that your machines and plants are always available.

### Service programs

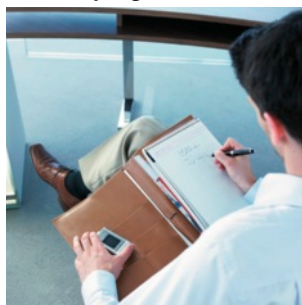

Our service programs are selected service packages for an automation and drives system or product group. The individual services are coordinated with each other to ensure smooth coverage of the entire life cycle and support optimum use of your products and systems.

The services of a Service Program can be flexibly adapted at any time and used separately.

### Spare parts



In every sector worldwide, plants and systems are required to operate with constantly increasing reliability. We will provide you with the support you need to prevent a standstill from occurring in the first place: with a worldwide network and optimum logistics chains.

Examples of service programs:

- Service contracts
- Plant IT Security Services
- Life Cycle Services for Drive Engineering
- SIMATIC PCS 7 Life Cycle Services
- SINUMERIK Manufacturing Excellence
- SIMATIC Remote Support Services

Advantages at a glance:

- Reduced downtimes for increased productivity
- Optimized maintenance costs due to a tailored scope of services
- Costs that can be calculated and therefore planned
- Service reliability due to guaranteed response times and spare part delivery times
- Customer service personnel will be supported and relieved of additional tasks
- Comprehensive service from a single source, fewer interfaces and greater expertise

### Repairs



Downtimes cause problems in the plant as well as unnecessary costs. We can help you to reduce both to a minimum - with our worldwide repair facilities.

### Optimization

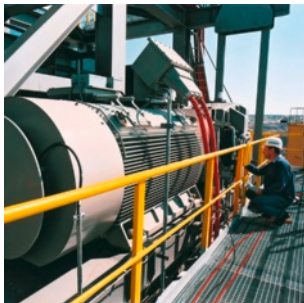

During the service life of machines and plants, there is often a great potential for increasing productivity or reducing costs. To help you achieve this potential, we are offering a complete range of optimization services.

Contact information is available in the Internet at:  
[www.siemens.com/automation/partner](http://www.siemens.com/automation/partner)

### Knowledge Base on DVD



For locations without online connections to the Internet there are excerpts of the free part of the information sources available on DVD (Service & Support Knowledge Base). This DVD contains all the latest product information at the time of production (FAQs, Downloads, Tips and Tricks, Updates) as well as general information on Service & Support.

The DVD also includes a full-text search and our Knowledge Manager for targeted searches for solutions. The DVD will be updated every 4 months.

Just the same as our online offer in the Internet, the Service & Support Knowledge Base on DVD comes complete in 5 languages (German, English, French, Italian, Spanish).

You can order the **Service & Support Knowledge Base** DVD from your Siemens contact.

Order no. **6ZB5310-0EP30-0BA2**

### Automation Value Card



#### Small card - great support

The Automation Value Card is an integral component of the comprehensive service concept with which Siemens Automation and Drives will accompany you in each phase of your automation project.

It doesn't matter whether you want just specific services from our Technical Support or want to purchase something on our Online portal, you can always pay with your Automation Value Card. No invoicing, transparent and safe. With your personal card number and associated PIN you can view the state of your account and all transactions at any time.

Services on card. This is how it's done.

Card number and PIN are on the back of the Automation Value Card. When delivered, the PIN is covered by a scratch field, guaranteeing that the full credit is on the card.

By entering the card number and PIN you have full access to the Service & Support services being offered. The charge for the services procured is debited from the credits on your Automation Value Card.

All the services offered are marked in currency-neutral credits, so you can use the Automation Value Card worldwide.

Order your Automation and Value Card easily and comfortably like a product with your sales contact.

#### Automation Value Card order numbers

Credits	Order no.
200	<b>6ES7 997-0BA00-0XA0</b>
500	<b>6ES7 997-0BB00-0XA0</b>
1 000	<b>6ES7 997-0BC00-0XA0</b>
10 000	<b>6ES7 997-0BG00-0XA0</b>

Detailed information on the services offered is available on our Internet site at:

[www.siemens.com/automation/service&support](http://www.siemens.com/automation/service&support)

Service & Support à la Card: Examples

#### Technical Support

"Priority"	Priority processing for urgent cases
"24 h"	Availability round the clock
"Extended"	Technical consulting for complex questions
"Mature Products"	Consulting service for products that are not available any more

#### Support Tools in the Support Shop

Tools that can be used directly for configuration, analysis and testing

# Appendix

## Service & Support

Siemens Solution Partner  
Automation, Power Distribution and PLM

### Overview



### Siemens Solution Partner Solution Partner Automation, Power Distribution and PLM

The products and systems from Siemens Industry Automation and Drive Technologies offer the ideal platform for all automation applications.

Under the name Siemens Solution Partner, selected system integrators operate around the world as uniformly qualified solution providers for the portfolio of Siemens automation, power distribution and product lifecycle management products. Day after day, they utilize their qualified product and system know-how as well as their excellent industry expertise to your advantage – for all requirements.

The Solution Partner emblem is a guarantee of quality. The basis for this is to be found in four defined quality features:

- **Solution quality:**  
A good result in every case based on proven solution know-how.
- **Expert quality:**  
Certified technical competence guarantees maximum efficiency.
- **Project quality:**  
Straight to the goal with proven project experience.
- **Product range quality:**  
Comprehensive portfolio for state-of-the-art solutions from a single source.

### Solution Partner Finder

The Siemens Solution Partner Program helps you to find the optimum partner for your specific requirements. Support is provided by the Solution Partner Finder, a comprehensive online database that showcases the profiles of all our solution partners. You can convince yourself of the competence of the respective Solution Partner by means of the references provided.

The following search criteria are possible:

- Country
- Technology
- Sector
- Company
- Zip code

Once you have located a partner, you are only one small step from contacting them.

You can locate the Solution Partner Finder as follows:

<http://www.siemens.com/automation/partnerfinder>

Additional information on the Siemens Solution Partner Program is available online at:

<http://www.siemens.com/automation/solutionpartner>

or under

[www.siemens.com/safety-partner](http://www.siemens.com/safety-partner)

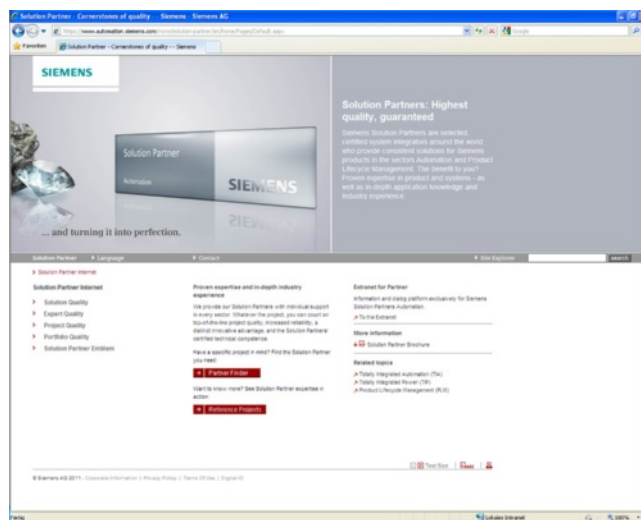

### Partners for Safety

"Siemens Solution Partner Automation" also involves highly professional participants in the field of safety technology. In such close cooperations you are eligible for professional consulting and support concerning all safety-relevant topics.

The presales and after-sales contributions comprise consulting on safety-relevant issues, the development of comprehensive safety concepts, planning and commissioning of projects, and running maintenance.



<b>A</b>	
Actuators for position switches .....	2/51, 2/52, 2/59, 2/60
Adapters for position switches .....	2/42
ASIMON .....	3/171
AS-Interface	
• ASIsafe .....	3/169–3/175
• Cable-operated switches .....	2/126
• DP/AS-i LINK Advanced .....	3/179
• DP/AS-Interface Link 20E .....	3/182
• DP-AS-i F-Link .....	3/184
• EMERGENCY-STOP mushroom pushbuttons .....	2/110, 2/119
• Enclosures for pushbuttons and indicator lights .....	2/118–2/120
• F adapters .....	2/110
• Hinge switches .....	2/89, 2/90
• IE/AS-i LINK PN IO .....	3/187
• Masters .....	3/177–3/178
• Position switches .....	2/74–2/90
• Routers .....	3/179–3/189
• Signaling columns .....	2/129, 2/132
• Slaves .....	2/120
AS-Interface sealing caps M12 .....	3/176
ASIsafe .....	3/169–3/175
• ASIMON .....	3/171
• Basic safety monitors .....	3/171
• Cable-operated switches .....	3/167
• EMERGENCY-STOP pushbuttons .....	3/167
• Expanded safety monitors .....	3/171
• K20F .....	3/174
• K45F .....	3/174
• K45F LS (light sensor) .....	3/174
• Position switches .....	3/167
• S22.5F .....	3/174
• Safety modules .....	3/174
• Safety monitors .....	3/171
• Software .....	3/171
ASIsafe CD .....	3/173
<b>B</b>	
Basic safety monitors for ASIsafe .....	3/171
BOP20 Basic Operator Panel .....	4/96
<b>C</b>	
Cable-operated switches .....	2/95, 2/122–2/126
• for ASIsafe .....	3/167
Cable sets	
• for ASIsafe .....	3/173
CALOMAT 6 .....	2/140
CompactFlash Card.....	4/109,4/113
Conditions for sale and delivery .....	5/30
Contact blocks	
• for magnetically operated switches .....	2/92
• for position switches .....	2/43
• for pushbuttons .....	2/99, 2/109, 2/117
Cover	
• for position switches .....	2/44
CP 243-2	
• for AS-Interface .....	3/177
CP 343-2	
• for AS-Interface .....	3/178
C-PLUG	
• for AS-Interface .....	3/181,3/189
CPU 315F-2 DP .....	3/3
CPU 315F-2 PN/DP .....	3/15
CPU 317F-2 DP .....	3/9
CPU 317F-2 PN/DP .....	3/23
CPU 317TF-2 DP .....	3/40
CPU 319F-3 PN/DP .....	3/31
CPU 412-3H .....	3/61
CPU 414-4H .....	3/67
CPU 414F-3 PN/DP .....	3/47
CPU 416F-2 .....	3/50
CPU 416F-3 PN/DP .....	3/50
CPU 417-4H .....	3/73
CU310 DP control unit.....	4/103
CU310 PN control unit.....	4/106
CU320-2 DP control unit.....	4/110
<b>D</b>	
Direct-on-line starters	
• ET 200pro.....	4/32–4/34
Distributed Safety V5.4 programming tool .....	3/83
DP/AS-i F-Link	
• for AS-Interface .....	3/184
DP/AS-i LINK Advanced	
• for AS-Interface .....	3/179
DP/AS-Interface Link 20E	
• for AS-Interface .....	3/182
<b>E</b>	
EMERGENCY-STOP pushbuttons .....	2/97, 2/98, 2/103, 2/104, 2/105, 2/106, 2/107, 2/108, 2/115, 2/119
EMERGENCY-STOP pushbuttons	
• for ASIsafe.....	3/167
Enclosures	
• for pushbuttons and indicator lights .....	2/114–2/119
Engineering software	
• Modular safety system ES .....	3/195–3/197
• Motor starter ES .....	4/29–4/31
ET 200eco .....	3/160
ET 200M .....	3/139
ET 200pro .....	3/119
• Motor starters .....	4/32–4/40
ET 200S .....	3/93
• Motor starters .....	4/4,4/9–4/23
Expanded safety monitors	
• For ASIsafe .....	3/171
Explosion protection (ATEX)	
• Hinge switches .....	2/69, 2/73
• Position switches .....	2/66–2/73
Export regulations .....	5/30
<b>F</b>	
F/FH Systems .....	3/84
Flowmeters .....	2/143
<b>G</b>	
Gas analyzers .....	2/140
<b>H</b>	
Hinge switches .....	2/2, 2/61–2/63, 2/89, 2/90
<b>I</b>	
IE FC RJ45 Plug 90	
• for AS-Interface .....	3/181, 3/189
IE/AS-i LINK PN IO	
• for AS-Interface .....	3/187
Incandescent lamps	
• for signaling columns and integrated signal lamps.....	2/130, 2/132
Indicator lights .....	2/94, 2/96
Integrated signal lamps .....	2/95, 2/134
Intelligent Operator Panel IOP Handheld.....	4/68
Interface modules	
• IM 151-7 F-CPU .....	3/93
• IM 151-8F PN/DP CPU .....	3/98
• IM 153-2 High Feature .....	3/142
• IM 153-4 PN High Feature .....	3/147
• IM 154-1 DP and IM 154-2 DP High Feature .....	3/121
• IM 154-4 PN High Feature .....	3/124
• IM 154-6 PN HF IWLAN .....	3/127
• IM 154-8 F PN/DP CPU .....	3/130

# Appendix

## Subject index

IOP Handheld .....4/68

### K

K20F for ASIsafe .....3/174  
 K45 mounting plates for ASIsafe .....3/176  
 K45F for ASIsafe .....3/174  
 K45F LS (light sensor) for ASIsafe .....3/174

### L

Lampholders  
 • for pushbuttons and indicator lights .....2/99, 2/109, 2/117  
 Lamps  
 • for signaling columns, integrated signal lamps .....2/130, 2/132  
 LEDs  
 • for signaling columns, integrated signal lamps .....2/130, 2/132

### M

Magnetically operated switches .....2/3, 2/91, 2/92  
 MASS 6000 .....2/144  
 MASS 6000 Ex-d transmitter .....2/146  
 Master interface module .....3/105  
 Masters for AS-Interface .....3/177–3/178  
 Mobile Panel 277(F) IWLAN .....2/135  
 Modular safety system ES .....3/195–3/197  
 Momentary-contact foot switches, foot switches .....2/95  
 Monitoring units  
 • for magnetically operated switches .....2/92  
 Motor management and control devices  
 • SIMOCODE pro 3UF7 .....3/213–3/226  
 Motor starter ES .....4/29–4/31  
 Motor starters  
 • ET 200pro .....4/32–4/40  
 • ET 200S .....4/4  
 Mushroom pushbuttons and switches .....2/103, 2/107

### O

Operator Panel IOP Handheld .....4/68  
 Operator Panel BOP20 Basic .....4/96  
 OXYMAT 6 .....2/140  
 OXYMAT 61 .....2/140

### P

Plug-in connections  
 • for position switches .....2/42  
 PM-E F PROFIsafe power modules .....3/106  
 Pointek  
 • CLS500 .....2/149  
 • CLS200 .....2/147  
 • CLS300 .....2/148  
 • ULS200 .....2/150  
 Position switches .....2/2–2/90  
 • Accessories for position switches  
 • Actuators .....2/51, 2/59  
 • Ambient temperature -40 °C .....2/20, 2/37  
 • AS-Interface .....2/74–2/90  
 • ASIsafe .....3/167  
 • Contact blocks .....2/43  
 • Explosion protection (ATEX) .....2/66–2/73  
 • Hinge switches .....2/2, 2/61–2/63, 2/89, 2/90  
 • Metal enclosures .....2/2, 2/22–2/40  
 • Molded-plastic enclosures .....2/2, 2/9–2/21  
 • Open-type .....2/2, 2/41  
 • Spare parts .....2/43, 2/44  
 • with interlocking .....2/3, 2/53, 2/87, 2/88  
 • with separate actuator .....2/3, 2/45–2/52, 2/83, 2/84, 2/85  
 • with tumbler .....2/60  
 Positive opening .....2/5  
 Pressure transmitters .....2/141  
 Process analytical instruments .....2/140  
 PROFIBUS DP master interface module .....3/105

PROFIBUS FastConnect bus connectors

• for AS-Interface .....3/181, 3/183  
 PROFIBUS FastConnect stripping tool  
 • for AS-Interface .....3/181, 3/183  
 PROFIBUS FC standard cable GP  
 • for AS-Interface .....3/181, 3/183  
 Protective caps  
 • for position switches .....2/43  
 • for pushbuttons .....2/111  
 Protective collars  
 • for pushbuttons and indicator lights .....2/111  
 Pushbuttons and indicator lights .....2/94, 2/96–2/120  
 • Nominal diameter 16 mm .....2/96–2/100  
 - Accessories and spare parts .....2/100  
 - Actuators .....2/98  
 - Complete units .....2/97  
 - Contact blocks .....2/99  
 - Lampholders .....2/99  
 • Nominal diameter 22 mm .....2/101–2/120  
 - Actuators .....2/108  
 - Contact blocks .....2/109  
 - Enclosures .....2/95, 2/114  
 - Enclosures for AS-Interface .....2/118–2/120  
 - Lampholders .....2/109  
 Pushbuttons and switches .....2/94, 2/96, 2/97, 2/98, 2/101

### R

Reversing starters  
 • ET 200pro .....4/32–4/34  
 Routers  
 • for AS-Interface .....3/179–3/189

### S

S22.5F  
 • for ASIsafe .....3/174  
 S7 F Systems .....3/86  
 S7 F/FH systems .....3/84  
 S7-300 isolation module .....3/159  
 Safety functions integrated into SINAMICS drives .....4/51  
 Safety matrix .....3/87  
 Safety modules  
 • for ASIsafe .....3/174  
 Safety monitors  
 • for ASIsafe .....3/171  
 Sealable covers  
 • for ASIsafe .....3/173  
 Signaling columns .....2/95, 2/127–2/133  
 SIMATIC mobile panel 277(F) IWLAN .....2/135  
 SIMOCODE pro 3UF7  
 • Accessories .....3/223–3/226  
 • Basic units .....3/220  
 • Expansion modules .....3/221  
 • Fail-safe expansion modules .....3/222  
 • General data .....3/213–3/219  
 SINAMICS .....4/45  
 • G120D .....4/66  
 • G130 .....4/77  
 • G150 .....4/80  
 • S110 .....4/82  
 • S120 .....4/97  
 • S150 .....4/117  
 SINUMERIK  
 • 828D .....4/122  
 • 840D sl .....4/119  
 SIPART PS2 .....2/153  
 SIRIUS 3RK3 modular safety system .....3/190  
 • Accessories .....3/194  
 • Central modules .....3/193  
 • Expansion modules .....3/193  
 • General data .....3/190–3/192  
 • Interface modules .....3/193  
 • Operating and monitoring modules .....3/193

SIRIUS 3SE5 position switches .....	2/4
SIRIUS 3TK28 safety relays	
• Accessories .....	3/212
• General data .....	3/198
• with contactor relay enabling circuits .....	3/207–3/209
• with electronic enabling circuits .....	3/204–3/206
• with relay enabling circuits .....	3/199–3/203
• with special functions .....	3/210, 3/211
SITRANS	
• F C mass flow meters .....	2/144
• F C MASSFLO coriolis mass flow meters .....	2/145
• F M MAG 6000 I/MAG 6000 I Ex d transmitter .....	2/143
• LC 500 .....	2/152
• LR200 .....	2/151
• P pressure transmitters .....	2/141
• TW universal transmitter .....	2/142
SIZER configuration tool .....	4/64
SM 326 F-digital output module .....	3/153
SM 336 F analog input module .....	3/156
Software licenses .....	5/29
Software redundancy .....	3/89
STARTER commissioning tool .....	4/65
Switching magnets .....	2/92
Sync module .....	3/79
<b>T</b>	
Terminal modules for electronic modules .....	3/117
Terminal modules	
• Fail-safe .....	4/11
• Safety modules local and PROFIsafe .....	4/18–4/19
• Standard .....	4/7
TM54F terminal module .....	4/114
Two-hand operation consoles .....	2/95, 2/121
<b>U</b>	
ULTRAMAT 23 .....	2/140
ULTRAMAT 6 .....	2/140
USB/serial adapters	
• for ASIsafe .....	3/173
<b>W</b>	
WinAC RTX F .....	3/91
<b>Y</b>	
Y-Link .....	3/80

# Appendix

## Order number index

### 2XV9

2XV9450-1SL03-0YX0.....	3/46, 3/158
2XV9450-1SL03-0YX0.....	3/46, 3/158
2XV9450-1SL03-0YX4.....	3/46, 3/158

### 3RA

3RA2908-1A.....	3/212
3RB1900-0B.....	3/224

### 3RK11

3RK1105-1AE04-0CA0.....	3/173
3RK1105-1AE04-2CA0.....	3/173
3RK1105-1AG04-0CA0.....	3/173
3RK1105-1AG04-2CA0.....	3/173
3RK1105-1BE04-0CA0.....	3/173
3RK1105-1BE04-2CA0.....	3/173
3RK1105-1BE04-4CA0.....	3/173
3RK1105-1BG04-0CA0.....	3/173
3RK1105-1BG04-2CA0.....	3/173
3RK1105-1BG04-4CA0.....	3/173

### 3RK12

3RK1205-0BE00-0AA2.....	3/175
3RK1205-0BG00-0AA2.....	3/175
3RK1205-0BQ00-0AA3.....	3/175
3RK1205-0BQ21-0AA3.....	3/175
3RK1205-0BQ24-0AA3.....	3/175
3RK1205-0BQ30-0AA3.....	3/175
3RK1205-0CQ00-0AA3.....	3/175

### 3RK13

3RK1301-0AB10-0AA4.....	4/8
3RK1301-0AB10-1AA4.....	4/8
3RK1301-0AB13-0AA4.....	4/10
3RK1301-0AB13-1AA4.....	4/10
3RK1301-0AB20-0AA4.....	4/8
3RK1301-0BB00-0AA2.....	4/6
3RK1301-0BB00-1AA2.....	4/6
3RK1301-0BB10-0AA4.....	4/8
3RK1301-0BB10-1AA4.....	4/8
3RK1301-0BB13-0AA4.....	4/10
3RK1301-0BB13-1AA4.....	4/10
3RK1301-0BB20-0AA4.....	4/8
3RK1301-0CB00-0AA2.....	4/6
3RK1301-0CB00-1AA2.....	4/6
3RK1301-0CB10-0AA4.....	4/8
3RK1301-0CB10-1AA4.....	4/8
3RK1301-0CB13-0AA4.....	4/10
3RK1301-0CB13-1AA4.....	4/10
3RK1301-0CB20-0AA4.....	4/8
3RK1301-0DB00-0AA2.....	4/6
3RK1301-0DB00-1AA2.....	4/6
3RK1301-0EB00-0AA2.....	4/6
3RK1301-0EB00-1AA2.....	4/6
3RK1301-0FB00-0AA2.....	4/6
3RK1301-0FB00-1AA2.....	4/6
3RK1301-0GB00-0AA2.....	4/6
3RK1301-0GB00-1AA2.....	4/6
3RK1301-0HB00-0AA2.....	4/6
3RK1301-0HB00-1AA2.....	4/6
3RK1301-0JB00-0AA2.....	4/6
3RK1301-0JB00-1AA2.....	4/6
3RK1301-0KB00-0AA2.....	4/6
3RK1301-0KB00-1AA2.....	4/6
3RK1301-1AB00-0AA2.....	4/6
3RK1301-1AB00-1AA2.....	4/6
3RK1301-1BB00-0AA2.....	4/6
3RK1301-1BB00-1AA2.....	4/6
3RK1301-1CB00-0AA2.....	4/6

3RK1301-1CB00-1AA2.....	4/6
3RK1301-1DB00-0AA2.....	4/6
3RK1301-1DB00-1AA2.....	4/6
3RK1301-1EB00-0AA2.....	4/6
3RK1301-1EB00-1AA2.....	4/6
3RK1301-1FB00-0AA2.....	4/6
3RK1301-1FB00-1AA2.....	4/6
3RK1301-1GB00-0AA2.....	4/6
3RK1301-1GB00-1AA2.....	4/6
3RK1301-1HB00-0AA2.....	4/6
3RK1301-1HB00-1AA2.....	4/6
3RK1301-1JB00-0AA2.....	4/6
3RK1301-1JB00-1AA2.....	4/6
3RK1301-1KB00-0AA2.....	4/6
3RK1301-1KB00-1AA2.....	4/6
3RK1304-0HS00-6AA0.....	4/37
3RK1304-0HS00-7AA0.....	4/36, 4/37
3RK1304-0HS00-8AA0.....	4/36
3RK1304-5KL40-4AA0.....	4/34
3RK1304-5KL70-2AA3.....	4/34
3RK1304-5KS40-2AA0.....	4/34
3RK1304-5KS40-2AA3.....	4/34
3RK1304-5KS40-3AA0.....	4/34
3RK1304-5KS40-4AA0.....	4/34
3RK1304-5KS40-4AA3.....	4/34
3RK1304-5KS40-5AA0.....	4/34
3RK1304-5KS70-2AA0.....	4/34
3RK1304-5KS70-2AA3.....	4/34
3RK1304-5KS70-3AA0.....	4/34
3RK1304-5KS70-3AA3.....	4/34
3RK1304-5LS40-2AA0.....	4/34
3RK1304-5LS40-3AA0.....	4/34
3RK1304-5LS40-3AA3.....	4/34
3RK1304-5LS40-4AA0.....	4/34
3RK1304-5LS40-5AA0.....	4/34
3RK1304-5LS70-2AA0.....	4/34
3RK1304-5LS70-2AA3.....	4/34
3RK1304-5LS70-3AA0.....	4/34
3RK1304-5LS70-3AA3.....	4/34

### 3RK14

3RK1405-0BE00-0AA2.....	3/175
3RK1405-0BG00-0AA2.....	3/175
3RK1405-0BQ20-0AA3.....	3/175
3RK1405-1BE00-0AA2.....	3/175
3RK1405-1BG00-0AA2.....	3/175
3RK1405-1BQ20-0AA3.....	3/175
3RK1405-1SE15-0AA2.....	3/175
3RK1405-1SG15-0AA2.....	3/175

### 3RK18

3RK1802-2FB06-0GA1.....	3/173
-------------------------	-------

### 3RK19

3RK1901-1AA00.....	3/176
3RK1901-1AA01.....	3/176
3RK1901-1KA00.....	3/176
3RK1901-1KA01.....	3/176
3RK1901-1NP00.....	3/176
3RK1901-2DA00.....	3/176
3RK1901-2EA00.....	3/176
3RK1901-5AA00.....	3/173
3RK1902-0AB00.....	4/40
3RK1902-0AJ00.....	4/40
3RK1902-0CC00.....	4/39
3RK1902-0CE00.....	4/39
3RK1902-0CJ00.....	4/40
3RK1902-0CT00.....	4/40
3RK1902-0CW00.....	4/40

3RK1902-2DA00.....	3/137
3RK1902-2HB30.....	3/136
3RK1902-2HB50.....	3/136
3RK1902-2HC10.....	3/136
3RK1902-2NB30.....	3/136
3RK1902-2NB50.....	3/136
3RK1902-2NC10.....	3/136
3RK1902-3BA00.....	3/137, 3/165
3RK1902-3DA00.....	3/137, 3/165
3RK1902-3GB30.....	3/137
3RK1902-3GB50.....	3/137
3RK1902-3GC10.....	3/137
3RK1902-3NB30.....	3/137, 3/165
3RK1902-3NB50.....	3/137, 3/165
3RK1902-3NC10.....	3/137, 3/165
3RK1902-4BA00-5AA0.....	3/166
3RK1903-0AA00.....	4/19
3RK1903-0AB00.....	4/7
3RK1903-0AB10.....	4/7
3RK1903-0AC00.....	4/7
3RK1903-0AC10.....	4/7
3RK1903-0AE00.....	4/22
3RK1903-0AF00.....	4/22
3RK1903-0AF20.....	4/22
3RK1903-0AG00.....	4/22
3RK1903-0AG01.....	4/22
3RK1903-0AH00.....	4/22
3RK1903-0AJ00.....	4/22
3RK1903-0AK00.....	4/8
3RK1903-0AK10.....	4/8
3RK1903-0AL00.....	4/8
3RK1903-0AL10.....	4/8
3RK1903-0CA00.....	4/21
3RK1903-0CB00.....	4/22
3RK1903-0CC00.....	4/22
3RK1903-0CD00.....	4/21
3RK1903-0CE00.....	4/22
3RK1903-0CF00.....	4/22
3RK1903-0CG00.....	4/21
3RK1903-0CH10.....	4/31
3RK1903-0CH20.....	4/21
3RK1903-1AA00.....	4/19
3RK1903-1AA10.....	4/19
3RK1903-1AB00.....	4/19
3RK1903-1AC00.....	4/19
3RK1903-1AC10.....	4/19
3RK1903-1AD10.....	4/19
3RK1903-1BA00.....	4/17
3RK1903-1BB00.....	4/17
3RK1903-1BC00.....	4/17
3RK1903-1BD00.....	4/17
3RK1903-1BE00.....	4/17
3RK1903-1CA00.....	4/23
3RK1903-1CA01.....	4/23
3RK1903-1CB00.....	4/23
3RK1903-2AA00.....	4/21
3RK1903-2AA10.....	4/21
3RK1903-2AC00.....	4/21, 4/22
3RK1903-2AC10.....	4/22
3RK1903-3AA00.....	4/19
3RK1903-3AB10.....	4/19
3RK1903-3AC00.....	4/11
3RK1903-3AC10.....	4/11
3RK1903-3AD00.....	4/11
3RK1903-3AD10.....	4/11
3RK1903-3AE00.....	4/19
3RK1903-3AE10.....	4/19
3RK1903-3BA01.....	4/17

3RK1903-3CA00.....	4/17	3RT1956-4EA3.....	3/224	3SB3301-1HA20.....	2/105
3RK1903-3DA00.....	4/17	3RT1956-4G.....	3/224	3SB3303-1HA20.....	2/105
3RK1911-0DB13.....	4/39	3RT1966-4EA1.....	3/224	3SB3400-0A.....	2/109
3RK1911-0DB33.....	4/39	3RT1966-4EA2.....	3/224	3SB3400-0AA.....	2/109
3RK1911-0DF13.....	4/39	3RT1966-4EA3.....	3/224	3SB3400-0B.....	2/109
3RK1911-0DF33.....	4/39	3RT1966-4G.....	3/224	3SB3400-0BA.....	2/109
3RK1911-0EB31.....	4/40	<b>3RX9</b>		3SB3400-0C.....	2/109
3RK1911-0ED31.....	4/40	3RX9802-0AA00.....	3/123, 3/125, 3/137, 3/138, 3/166	3SB3400-0CA.....	2/109
3RK1911-2BE10.....	4/39	3RX9802-0AA00.....	4/40	3SB3400-0D.....	2/109
3RK1911-2BE10.....	4/44	<b>3SB1</b>		3SB3400-0DA.....	2/109
3RK1911-2BE30.....	4/39	3SB1902-2BA.....	2/112	3SB3400-0E.....	2/109
3RK1911-2BE30.....	4/44	3SB1902-2BB.....	2/112	3SB3400-0EA.....	2/109
3RK1911-2BE50.....	4/39	3SB1902-2BH.....	2/111	3SB3400-0H.....	2/109
3RK1911-2BE50.....	4/44	<b>3SB2</b>		3SB3400-0HA.....	2/109
3RK1911-2BF10.....	4/39	3SB2000-1AC01.....	2/98	3SB3400-0M.....	2/109
3RK1911-2BF50.....	4/39	3SB2203-1AC01.....	2/97	3SB3400-0Q.....	2/109
3RK1911-2BL21.....	4/39	3SB2404-0B.....	2/99	3SB3420-0B.....	2/117
3RK1911-2BL22.....	4/39	3SB2404-0C.....	2/99	3SB3420-0BA.....	2/117
3RK1911-2BM21.....	4/39	3SB2455-0B.....	2/99	3SB3420-0C.....	2/117
3RK1911-2BM22.....	4/39	3SB2455-0C.....	2/99	3SB3420-0CA.....	2/117
3RK1911-2BS20.....	4/39	3SB2455-0F.....	2/99	3SB3423-0B.....	2/117
3RK1911-2BS40.....	4/39	3SB2455-0J.....	2/99	3SB3423-0BA.....	2/117
3RK1911-2BS60.....	4/39	3SB2908-0AA.....	2/99	3SB3423-0C.....	2/117
3RK1922-2BA00.....	4/40	3SB2908-0AB.....	2/99	3SB3423-0CA.....	2/117
3RK1922-2BA01.....	4/40	3SB2908-0AF.....	2/100	3SB3500-1AA20.....	2/108
3RK1922-2BP00.....	4/31, 4/40	3SB2908-2AG.....	2/100	3SB3500-1BA20.....	2/108
3RK1922-2BP00.....	4/44, 4/74	3SB2908-2AK.....	2/100	3SB3500-1FA20.....	2/108
3RK1922-2BQ00.....	4/39	3SB2908-2AA.....	2/100	3SB3500-1FA20-0PA0.....	2/108
3RK1922-2BQ00.....	4/44	3SB2908-8AA.....	2/100	3SB3500-1HA20.....	2/108
3RK1922-3BA00.....	4/21, 4/40	3SB2908-8AB.....	2/100	3SB3500-1HA20-0PA0.....	2/108
<b>3RK3</b>		3SB2908-8AD.....	2/100	3SB3500-1HA26.....	2/108
3RK3111-1AA10.....	3/193	3SB2908-8AE.....	2/100	3SB3500-1KA20.....	2/108
3RK3111-2AA10.....	3/193	<b>3SB3</b>		3SB3500-1LA20.....	2/108
3RK3141-1CD10.....	3/186	3SB3000-1AA20.....	2/104	3SB3500-1TA20.....	2/108
3RK3141-2CD10.....	3/186	3SB3000-1BA20.....	2/104	3SB3601-1HA20.....	2/107
3RK3211-1AA10.....	3/193	3SB3000-1FA20.....	2/104	3SB3601-1HA20-0CC0.....	2/107
3RK3211-2AA10.....	3/193	3SB3000-1HA20.....	2/104	3SB3601-1HA26.....	2/107
3RK3221-1AA10.....	3/193	3SB3000-1HA26.....	2/104	3SB3601-1HA26-0CC0.....	2/107
3RK3221-2AA10.....	3/193	3SB3000-1KA20.....	2/104	3SB3601-1HP20.....	2/107
3RK3231-1AA10.....	3/193	3SB3000-1LA20.....	2/104	3SB3601-1HR20.....	2/107
3RK3231-2AA10.....	3/193	3SB3000-1MA20.....	2/104	3SB3601-1HR26.....	2/107
3RK3242-1AA10.....	3/193	3SB3000-1TA20.....	2/104	3SB3601-1TA20.....	2/107
3RK3242-2AA10.....	3/193	3SB3110-1BA20.....	2/106	3SB3601-1TA20-0CC0.....	2/107
3RK3251-1AA10.....	3/193	3SB3110-1HA20.....	2/106	3SB3601-1TP20.....	2/107
3RK3251-2AA10.....	3/193	3SB3110-1KA20.....	2/106	3SB3601-1TR20.....	2/107
3RK3311-1AA10.....	3/193	3SB3110-1LA20.....	2/106	3SB3603-1HA20.....	2/107
3RK3321-1AA10.....	3/193	3SB3110-1MA20.....	2/106	3SB3603-1HA20-0CC0.....	2/107
3RK3321-2AA10.....	3/193	3SB3201-1HA20.....	2/103	3SB3603-1HA26.....	2/107
3RK3511-1BA10.....	3/193	3SB3201-1HA20-0CC0.....	2/103	3SB3603-1HA26-0CC0.....	2/107
3RK3511-2BA10.....	3/193	3SB3201-1HA26.....	2/103	3SB3603-1HP20.....	2/107
3RK3611-3AA00.....	3/193	3SB3201-1HA26-0CC0.....	2/103	3SB3603-1HR20.....	2/107
3RK3931-0AA00.....	3/194	3SB3201-1HP20.....	2/103	3SB3603-1HR26.....	2/107
<b>3RP1</b>		3SB3201-1HR20.....	2/103	3SB3603-1TA20.....	2/107
3RP1902.....	3/173	3SB3201-1HR26.....	2/103	3SB3603-1TA20-0CC0.....	2/107
3RP1902.....	3/212	3SB3201-1TA20.....	2/103	3SB3603-1TP20.....	2/107
3RP1903.....	3/173	3SB3201-1TR20.....	2/103	3SB3603-1TR20.....	2/107
3RP1903.....	3/194, 3/212, 3/224	3SB3203-1HA20.....	2/103	3SB3611-1HA20-0CC0.....	2/107
<b>3RT1</b>		3SB3203-1HA20-0CC0.....	2/103	3SB3611-1TA20-0CC0.....	2/107
3RT1900-1SB20.....	3/129, 3/166	3SB3203-1HA26.....	2/103	3SB3801-0AA3.....	2/116
3RT1900-1SB20.....	3/212	3SB3203-1HA26-0CC0.....	2/103	3SB3801-0AB3.....	2/116
3RT1900-1SB60.....	3/212	3SB3203-1HP20.....	2/103	3SB3801-0AD3.....	2/116
3RT1900-1SD60.....	3/212	3SB3203-1HR20.....	2/103	3SB3801-0DF3.....	2/115
3RT1955-4G.....	3/224	3SB3203-1HR26.....	2/103	3SB3801-0DG3.....	2/115
3RT1956-4EA1.....	3/224	3SB3203-1HR26.....	2/103	3SB3801-0EF3.....	2/115
3RT1956-4EA2.....	3/224	3SB3203-1TA20.....	2/103	3SB3801-0EG3.....	2/115
		3SB3203-1TR20.....	2/103	3SB3801-2AA3.....	2/116
				3SB3801-2AB3.....	2/116

# Appendix

## Order number index

3SB3801-2AD3 .....	2/116	3SE2283-0GA53 .....	2/65	3SE5000-0AA26 .....	2/16, 2/19, 2/25, 2/33, 2/36, 2/68, 2/72, 2/77, 2/79, 2/81
3SB3801-2AE3 .....	2/116	3SE2283-6GA43 .....	2/65	3SE5000-0AA31 .....	2/12, 2/19, 2/25, 2/68, 2/77, 2/79
3SB3801-2DF3 .....	2/115	3SE2283-6GA44 .....	2/65	3SE5000-0AA31-1AJ0 .....	2/21
3SB3801-2DG3 .....	2/115	3SE2283-6GA53 .....	2/65	3SE5000-0AA32 .....	2/12, 2/19, 2/25, 2/68, 2/77, 2/79
3SB3801-2EA30 .....	2/115	3SE2830-0XX00 .....	2/60	3SE5000-0AA60 .....	2/12, 2/16, 2/19, 2/25, 2/29, 2/33, 2/36, 2/68, 2/72, 2/77, 2/79, 2/81
3SB3801-2EA30-0CC0 .....	2/115	3SE2830-1XX00 .....	2/60	3SE5000-0AA60-1AJ0 .....	2/21, 2/38
3SB3801-2EC3 .....	2/116	3SE2830-6XX00 .....	2/60	3SE5000-0AA61 .....	2/12, 2/16, 2/19, 2/25, 2/29, 2/33, 2/36, 2/68, 2/72, 2/77, 2/79, 2/81
3SB3801-2EF3 .....	2/115	3SE2831-0XX00 .....	2/60	3SE5000-0AA62 .....	2/12, 2/16, 2/19, 2/25, 2/29, 2/33, 2/36, 2/68, 2/72, 2/77, 2/79, 2/81
3SB3801-2EG10-0CC0 .....	2/115	3SE2831-1XX20 .....	2/60	3SE5000-0AA62-1AJ0 .....	2/21, 2/38
3SB3801-2EG3 .....	2/115	3SE2831-6XX00 .....	2/60	3SE5000-0AA63 .....	2/12, 2/16, 2/19, 2/25, 2/29, 2/33, 2/36, 2/68, 2/72, 2/77, 2/79, 2/81
3SB3802-0AA3 .....	2/116	3SE2832-0XX00 .....	2/60	3SE5000-0AA67 .....	2/12, 2/19, 2/25, 2/33, 2/36, 2/68, 2/77, 2/79, 2/81
3SB3802-2AA3 .....	2/116	3SE2832-1XX20 .....	2/60	3SE5000-0AA68 .....	2/12, 2/16, 2/19, 2/25, 2/29, 2/33, 2/36, 2/68, 2/72, 2/77, 2/79, 2/81
3SB3803-0AA3 .....	2/116	3SE2832-6XX00 .....	2/60	3SE5000-0AA68 .....	2/12, 2/16, 2/19, 2/25, 2/29, 2/33, 2/36, 2/68, 2/72, 2/77, 2/79, 2/81
3SB3803-2AA3 .....	2/116	3SE2840-0XX00 .....	2/60	3SE5000-0AA68 .....	2/12, 2/16, 2/19, 2/25, 2/29, 2/33, 2/36, 2/68, 2/72, 2/77, 2/79, 2/81
3SB3804-0AA3 .....	2/116	3SE2840-1XX01 .....	2/60	3SE5000-0AB01 .....	2/16, 2/24, 2/29, 2/32, 2/35, 2/67, 2/71, 2/79, 2/80
3SB3804-2AA3 .....	2/116	3SE2840-1XX20 .....	2/60	3SE5000-0AC02 .....	2/29, 2/32, 2/35, 2/71, 2/80
3SB3806-0AA3 .....	2/116	3SE2840-6XX01 .....	2/60	3SE5000-0AC02-1AJ0 .....	2/38
3SB3806-2AA3 .....	2/116	3SE2840-1XX00 .....	2/60	3SE5000-0AC03 .....	2/16
3SB3863-1BB3 .....	2/121	3SE2840-1XX20 .....	2/60	3SE5000-0AC30 .....	2/43
3SB3863-4BA .....	2/121	3SE2840-1XX32 .....	2/60	3SE5000-0AD02 .....	2/29, 2/32, 2/35, 2/71, 2/80
3SB3863-4BB .....	2/121	3SE2840-6XX00 .....	2/60	3SE5000-0AD02-1AJ0 .....	2/38
3SB3863-4BC .....	2/121	3SE2840-6XX01 .....	2/60	3SE5000-0AD03 .....	2/12, 2/19, 2/24, 2/67, 2/77, 2/79
3SB3901-0AB .....	2/113	3SE2841-0XX00 .....	2/60	3SE5000-0AD03-1AJ0 .....	2/21
3SB3901-0AC .....	2/113	3SE2841-1XX20 .....	2/60	3SE5000-0AD04 .....	2/12, 2/19, 2/24, 2/67, 2/77, 2/79
3SB3901-0AQ3 .....	2/121	3SE2841-1XX32 .....	2/60	3SE5000-0AD05 .....	2/16
3SB3901-0AW .....	2/113	3SE2841-6XX00 .....	2/60	3SE5000-0AD06 .....	2/16
3SB3921-0AB .....	2/112	3SE2841-6XX01 .....	2/60	3SE5000-0AD10 .....	2/12, 2/19, 2/25, 2/67, 2/77, 2/79
3SB3921-0AC .....	2/112	3SE2842-0XX00 .....	2/60	3SE5000-0AD11 .....	2/12, 2/19, 2/25, 2/67, 2/77, 2/79
3SB3921-0AD .....	2/112	3SE2842-1XX00 .....	2/60	3SE5000-0AE01 .....	2/29, 2/32, 2/35, 2/71, 2/81
3SB3921-0AG .....	2/112	3SE2842-1XX20 .....	2/60	3SE5000-0AE01-1AJ0 .....	2/38
3SB3921-0AK .....	2/111	3SE2842-1XX32 .....	2/60	3SE5000-0AE02 .....	2/29, 2/32, 2/35, 2/71, 2/81
3SB3921-0AN .....	2/112	3SE2842-6XX00 .....	2/60	3SE5000-0AE03 .....	2/29, 2/32, 2/35, 2/71, 2/81
3SB3921-0AP .....	2/111	3SE2842-6XX01 .....	2/60	3SE5000-0AE03-1AJ0 .....	2/38
3SB3921-0AX .....	2/111	3SE5000-0AA01 .....	2/16, 2/29, 2/33, 2/36, 2/72, 2/81	3SE5000-0AE04 .....	2/29, 2/32, 2/35, 2/71, 2/81
3SB3921-0BD .....	2/113	3SE5000-0AA01-1AJ0 .....	2/38	3SE5000-0AE05 .....	2/16
3SB3921-0BU .....	2/111	3SE5000-0AA02 .....	2/16, 2/29, 2/33, 2/36, 2/72, 2/81	3SE5000-0AE10 .....	2/12, 2/19, 2/25, 2/68, 2/77, 2/79
3SB3921-0BW .....	2/112	3SE5000-0AA03 .....	2/16, 2/29, 2/33, 2/36, 2/72, 2/81	3SE5000-0AE10-1AJ0 .....	2/21
3SB3921-0CG .....	2/111	3SE5000-0AA04 .....	2/16, 2/29, 2/33, 2/36, 2/72, 2/81	3SE5000-0AE11 .....	2/12, 2/19, 2/25, 2/68, 2/77, 2/79
3SB3921-0CH .....	2/112	3SE5000-0AA05 .....	2/16, 2/29, 2/33, 2/36, 2/72, 2/81	3SE5000-0AE12 .....	2/12, 2/19, 2/25, 2/68, 2/77, 2/79
3SB3921-0CK .....	2/112	3SE5000-0AA07 .....	2/33, 2/36, 2/81	3SE5000-0AE12-1AJ0 .....	2/21
3SB3921-0DA .....	2/112	3SE5000-0AA08 .....	2/16, 2/29, 2/33, 2/36, 2/72, 2/81	3SE5000-0AE13 .....	2/12, 2/19, 2/25, 2/68, 2/77, 2/79
3SB3921-0DA .....	2/112	3SE5000-0AA11 .....	2/16, 2/29, 2/33, 2/36, 2/72, 2/81	3SE5000-0AF01 .....	2/29, 2/32, 2/35, 2/71, 2/81
3SB3921-0DC .....	2/112	3SE5000-0AA11-1AJ0 .....	2/38	3SE5000-0AF01-1AJ0 .....	2/38
3SB3921-0DD .....	2/112	3SE5000-0AA12 .....	2/16, 2/29, 2/33, 2/36, 2/72, 2/81	3SE5000-0AF02 .....	2/29, 2/32, 2/35, 2/71, 2/81
3SB3921-0DK .....	2/112	3SE5000-0AA15 .....	2/16, 2/29, 2/33, 2/36, 2/72, 2/81	3SE5000-0AF03 .....	2/29, 2/32, 2/35, 2/71, 2/81
3SB3921-0DY .....	2/112	3SE5000-0AA21 .....	2/12, 2/19, 2/25, 2/68, 2/77, 2/79	3SE5000-0AF03-1AJ0 .....	2/38
3SB3931-0AA .....	2/113	3SE5000-0AA21-1AJ0 .....	2/21		
3SB3931-0AC .....	2/113	3SE5000-0AA22 .....	2/12, 2/19, 2/25, 2/68, 2/77, 2/79		
3SB3941-0AB .....	2/112	3SE5000-0AA23 .....	2/12, 2/19, 2/25, 2/68, 2/77, 2/79		
3SB3941-0AC .....	2/112	3SE5000-0AA24 .....	2/12, 2/16, 2/19, 2/25, 2/29, 2/33, 2/36, 2/68, 2/72, 2/77, 2/79, 2/81		
3SB3941-0AD .....	2/112	3SE5000-0AA25 .....	2/12, 2/19, 2/25, 2/68, 2/77, 2/79		
3SB3941-0BX .....	2/112				
3SB3951-0AA .....	2/113				
<b>3SE2</b>					
3SE2243-0XX .....	2/52				
3SE2243-0XX18 .....	2/52				
3SE2243-0XX30 .....	2/52				
3SE2243-0XX38 .....	2/52				
3SE2243-0XX40 .....	2/52				
3SE2243-0XX48 .....	2/52				
3SE2257-6XX .....	2/52				
3SE2257-6XX18 .....	2/52				
3SE2257-6XX30 .....	2/52				
3SE2257-6XX38 .....	2/52				
3SE2257-6XX40 .....	2/52				
3SE2257-6XX48 .....	2/52				
3SE2283-0GA43 .....	2/65				
3SE2283-0GA44 .....	2/65				

3SE5000-0AF04 .....	2/29, 2/32, 2/35, 2/71, 2/81	3SE5112-0CC02-1DA0 .....	2/70	3SE5114-1RV10-1AF3 .....	2/50
3SE5000-0AF05 .....	2/16	3SE5112-0CD02 .....	2/26	3SE5115-0CA00-1AD0 .....	2/28
3SE5000-0AF10 .....	2/12, 2/19, 2/25, 2/68, 2/77, 2/79	3SE5112-0CD02-1DA0 .....	2/70	3SE5115-0KA00-1AD1 .....	2/28
3SE5000-0AF10-1AJ0 .....	2/21	3SE5112-0CE01 .....	2/26	3SE5115-0LA00-1AD1 .....	2/28
3SE5000-0AF11 .....	2/12, 2/19, 2/25, 2/68, 2/77, 2/79	3SE5112-0CE03-1DA0 .....	2/70	3SE5115-0QV10-1AD1 .....	2/50
3SE5000-0AF12 .....	2/12, 2/19, 2/25, 2/68, 2/77, 2/79	3SE5112-0CF01 .....	2/26	3SE5115-1BA00-1AF2 .....	2/28
3SE5000-0AF12-1AJ0 .....	2/21	3SE5112-0CF03-1DA0 .....	2/70	3SE5115-1CA00-1AF2 .....	2/28
3SE5000-0AF13 .....	2/12, 2/19, 2/25, 2/68, 2/77, 2/79	3SE5112-0CH01 .....	2/27	3SE5115-1LA00-1AD2 .....	2/28
3SE5000-0AH00 .....	2/29, 2/33, 2/36, 2/72, 2/81	3SE5112-0CH02 .....	2/27	3SE5115-1RV10-1AF2 .....	2/50
3SE5000-0AH00-1AJ0 .....	2/38	3SE5112-0CH11-1DA0 .....	2/70	3SE5120-0AA00-1AG0 .....	2/44
3SE5000-0AJ00 .....	2/16	3SE5112-0CH24 .....	2/27	3SE5120-1AA00 .....	2/44
3SE5000-0AK00 .....	2/12, 2/19, 2/25, 2/68, 2/77, 2/79	3SE5112-0CH60 .....	2/27	3SE5120-1AA00-1AG0 .....	2/44
3SE5000-0AK00-1AJ0 .....	2/21	3SE5112-0CH62-1AJ0 .....	2/37	3SE5120-3AA00 .....	2/44
3SE5000-0AT01 .....	2/29, 2/33, 2/36, 2/72, 2/81	3SE5112-0CT11 .....	2/27	3SE5120-3AA00-1AG0 .....	2/44
3SE5000-0AT02 .....	2/29, 2/33, 2/36, 2/72, 2/81	3SE5112-0CT13-1DA0 .....	2/70	3SE5122-0AA0 .....	2/43
3SE5000-0AT03 .....	2/29, 2/33, 2/36, 2/72, 2/81	3SE5112-0KA00 .....	2/28	3SE5122-0AA00-1CA0 .....	2/43
3SE5000-0AT04 .....	2/33, 2/36, 2/72, 2/81	3SE5112-0KA00-1AJ0 .....	2/37	3SE5122-0BA00 .....	2/32
3SE5000-0AT10 .....	2/29, 2/33, 2/36, 2/72, 2/81	3SE5112-0KA00-1CA0 .....	2/28	3SE5122-0BA00-1CA0 .....	2/32
3SE5000-0AU21 .....	2/62, 2/63, 2/89, 2/90	3SE5112-0KA00-1DA0 .....	2/71	3SE5122-0BA00-1DA0 .....	2/71
3SE5000-0AU22 .....	2/62, 2/63, 2/89, 2/90	3SE5112-0KB01 .....	2/26	3SE5122-0BB01 .....	2/30
3SE5000-0AV01 .....	2/51, 2/59, 2/85	3SE5112-0KC02 .....	2/26	3SE5122-0BC02 .....	2/30
3SE5000-0AV02 .....	2/51, 2/59, 2/85	3SE5112-0KD02 .....	2/26	3SE5122-0BD02 .....	2/30
3SE5000-0AV03 .....	2/51, 2/59, 2/85	3SE5112-0KE01 .....	2/26	3SE5122-0BE01 .....	2/30
3SE5000-0AV04 .....	2/51, 2/59, 2/85	3SE5112-0KH01 .....	2/27	3SE5122-0BF01 .....	2/30
3SE5000-0AV05 .....	2/51, 2/59, 2/85	3SE5112-0LA00 .....	2/28	3SE5122-0BH01 .....	2/31
3SE5000-0AV06 .....	2/51, 2/59, 2/85	3SE5112-0LA00-1AJ0 .....	2/37	3SE5122-0BH60 .....	2/31
3SE5000-0AV07 .....	2/51, 2/59, 2/85	3SE5112-0LA00-1CA0 .....	2/28	3SE5122-0CA00 .....	2/32
3SE5000-0AV07-1AK2 .....	2/51, 2/59, 2/85	3SE5112-0LA00-1DA0 .....	2/71	3SE5122-0CA00-1AJ0 .....	2/37
3SE5000-0AV08-1AA2 .....	2/51, 2/59, 2/85	3SE5112-0LB01 .....	2/26	3SE5122-0CA00-1CA0 .....	2/32
3SE5000-0AV08-1AA3 .....	2/51, 2/59, 2/85	3SE5112-0LC02 .....	2/26	3SE5122-0CA00-1DA0 .....	2/71
3SE5000-0BA00 .....	2/43	3SE5112-0LD02 .....	2/26	3SE5122-0CB01 .....	2/30
3SE5000-0CA00 .....	2/43	3SE5112-0LE01 .....	2/26	3SE5122-0CC02 .....	2/30
3SE5000-0CA00-1AC1 .....	2/43	3SE5112-0LF01 .....	2/26	3SE5122-0CC02-1DA0 .....	2/70
3SE5000-0GA00 .....	2/43	3SE5112-0LH01 .....	2/27	3SE5122-0CD02 .....	2/30
3SE5000-0KA00 .....	2/43	3SE5112-0LH60 .....	2/27	3SE5122-0CD02-1DA0 .....	2/70
3SE5000-0LA00 .....	2/43	3SE5112-0LU21 .....	2/63	3SE5122-0CE01 .....	2/30
3SE5000-0MA00 .....	2/43	3SE5112-0LU21-1DA0 .....	2/73	3SE5122-0CE02 .....	2/30
3SE5000-0NA00 .....	2/43	3SE5112-0LU22 .....	2/63	3SE5122-0CE03-1DA0 .....	2/70
3SE5000-0PA00 .....	2/43	3SE5112-0LU22-1DA0 .....	2/73	3SE5122-0CF01 .....	2/30
3SE5110-0AA00-1AG0 .....	2/44	3SE5112-0MA00 .....	2/28	3SE5122-0CF03-1DA0 .....	2/70
3SE5110-1AA00 .....	2/44	3SE5112-0MA00-1CA0 .....	2/28	3SE5122-0CH01 .....	2/31
3SE5110-1AA00-1AG0 .....	2/44	3SE5112-0MA00-1DA0 .....	2/71	3SE5122-0CH02 .....	2/31
3SE5110-3AA00 .....	2/44	3SE5112-0PA00 .....	2/28	3SE5122-0CH11-1DA0 .....	2/70
3SE5110-3AA00-1AG0 .....	2/44	3SE5112-0PA00-1CA0 .....	2/28	3SE5122-0CH60 .....	2/31
3SE5112-0AA00 .....	2/43	3SE5112-0PA00-1DA0 .....	2/71	3SE5122-0CT11 .....	2/31
3SE5112-0AA00-1CA0 .....	2/43	3SE5112-0QV10 .....	2/50	3SE5122-0KA00 .....	2/32
3SE5112-0BA00 .....	2/28	3SE5112-0QV10-1AA7 .....	2/50	3SE5122-0KA00-1AJ0 .....	2/37
3SE5112-0BA00-1CA0 .....	2/28	3SE5112-0QV10-1DA0 .....	2/73	3SE5122-0KA00-1CA0 .....	2/32
3SE5112-0BA00-1DA0 .....	2/71	3SE5112-1KA00 .....	2/28	3SE5122-0KA00-1DA0 .....	2/71
3SE5112-0BB01 .....	2/26	3SE5112-1LA00 .....	2/28	3SE5122-0KB01 .....	2/30
3SE5112-0BC02 .....	2/26	3SE5112-1QV10 .....	2/50	3SE5122-0KC02 .....	2/30
3SE5112-0BD02 .....	2/26	3SE5112-3KA00 .....	2/28	3SE5122-0KD02 .....	2/30
3SE5112-0BE01 .....	2/26	3SE5112-3LA00 .....	2/28	3SE5122-0KE01 .....	2/30
3SE5112-0BF01 .....	2/26	3SE5112-3QV10 .....	2/50	3SE5122-0KH01 .....	2/31
3SE5112-0BH01 .....	2/27	3SE5114-0BA00-1AC5 .....	2/28	3SE5122-0LA00 .....	2/32
3SE5112-0BH02 .....	2/27	3SE5114-0CA00-1AC5 .....	2/28	3SE5122-0LA00-1AJ0 .....	2/37
3SE5112-0BH60 .....	2/27	3SE5114-0CH01-1AC5 .....	2/27	3SE5122-0LA00-1CA0 .....	2/32
3SE5112-0CA00 .....	2/28	3SE5114-0KA00-1AE1 .....	2/28	3SE5122-0LA00-1DA0 .....	2/71
3SE5112-0CA00-1AC1 .....	2/28	3SE5114-0LA00-1AE1 .....	2/28	3SE5122-0LB01 .....	2/30
3SE5112-0CA00-1AJ0 .....	2/37	3SE5114-0QV10-1AE1 .....	2/50	3SE5122-0LC02 .....	2/30
3SE5112-0CA00-1CA0 .....	2/28	3SE5114-0RV10-1AC5 .....	2/50	3SE5122-0LD02 .....	2/30
3SE5112-0CA00-1DA0 .....	2/71	3SE5114-1BA00-1AF3 .....	2/28	3SE5122-0LE01 .....	2/30
3SE5112-0CB01 .....	2/26	3SE5114-1CA00-1AF3 .....	2/28	3SE5122-0LH01 .....	2/31
3SE5112-0CC02 .....	2/26	3SE5114-1CD02-1AF3 .....	2/26	3SE5122-0LH02 .....	2/31
		3SE5114-1CH01-1AF3 .....	2/27	3SE5122-0LH60 .....	2/31
		3SE5114-1CH02-1AF3 .....	2/27	3SE5122-0MA00 .....	2/32
		3SE5114-1LA00-1AD4 .....	2/28	3SE5122-0MA00-1CA0 .....	2/32
		3SE5114-1LH50-1AD4 .....	2/27	3SE5122-0MA00-1DA0 .....	2/71

# Appendix

## Order number index

3SE5122-0PA00 .....	2/32	3SE5132-3QV20 .....	2/48	3SE5212-0LU21-1DA0 .....	2/69
3SE5122-0PA00-1CA0 .....	2/32	3SE5134-0BA00-1AC4 .....	2/15	3SE5212-0LU22 .....	2/63
3SE5122-0PA00-1DA0 .....	2/71	3SE5134-0CA00-1AC4 .....	2/15	3SE5212-0LU22-1DA0 .....	2/69
3SE5122-0QV10 .....	2/50	3SE5134-0KA00-1AE0 .....	2/15	3SE5212-0MCO5 .....	2/22, 2/24
3SE5122-0QV10-1AA7 .....	2/50	3SE5134-0LA00-1AE0 .....	2/15	3SE5212-0MCO5-1CA0 .....	2/22, 2/24
3SE5122-0QV10-1DA0 .....	2/73	3SE5160-0AA00-1AG0 .....	2/44	3SE5212-0MCO5-1DA0 .....	2/67
3SE5122-1KA00 .....	2/32	3SE5162-0AA00 .....	2/43	3SE5212-0PC05 .....	2/22, 2/24
3SE5122-1LA00 .....	2/32	3SE5162-0BA00 .....	2/35	3SE5212-0PC05-1CA0 .....	2/22, 2/24
3SE5122-1QV10 .....	2/50	3SE5162-0BA00-1CA0 .....	2/35	3SE5212-0PC05-1DA0 .....	2/67
3SE5122-3KA00 .....	2/32	3SE5162-0BA00-1DA0 .....	2/71	3SE5212-0QV40 .....	2/49
3SE5122-3LA00 .....	2/32	3SE5162-0BD02 .....	2/34	3SE5212-0QV40-1DA0 .....	2/69
3SE5122-3QV10 .....	2/50	3SE5162-0BE01 .....	2/34	3SE5212-0RV40 .....	2/49
3SE5130-0AA00-1AG0 .....	2/44	3SE5162-0CA00 .....	2/35	3SE5212-1KC05 .....	2/22, 2/24
3SE5130-1AA00 .....	2/44	3SE5162-0CA00-1CA0 .....	2/35	3SE5212-1LC05 .....	2/22, 2/24
3SE5130-1AA00-1AG0 .....	2/44	3SE5162-0CA00-1DA0 .....	2/71	3SE5212-1RV40 .....	2/49
3SE5130-3AA00 .....	2/44	3SE5162-0CB01 .....	2/34	3SE5212-3KC05 .....	2/22, 2/24
3SE5130-3AA00-1AG0 .....	2/44	3SE5162-0CD02 .....	2/34	3SE5212-3LC05 .....	2/22, 2/24
3SE5132-0BA00 .....	2/15	3SE5162-0CE01 .....	2/34	3SE5212-3RV40 .....	2/49
3SE5132-0BA00-1CA0 .....	2/15	3SE5162-0CE02 .....	2/34	3SE5214-0BC05-1AC5 .....	2/22, 2/24
3SE5132-0BB01 .....	2/13	3SE5162-0CF01 .....	2/34	3SE5214-0CC05-1AC5 .....	2/22, 2/24
3SE5132-0BC03 .....	2/13	3SE5162-0CH01 .....	2/34	3SE5214-0KC05-1AE1 .....	2/22, 2/24
3SE5132-0BD05 .....	2/13	3SE5162-0DA00 .....	2/35	3SE5214-0LC05-1AE1 .....	2/22, 2/24
3SE5132-0BE05 .....	2/13	3SE5162-0DA00-1CA0 .....	2/35	3SE5214-1BC05-1AF3 .....	2/22, 2/24
3SE5132-0BF05 .....	2/13	3SE5162-0DA00-1DA0 .....	2/71	3SE5214-1CC05-1AF3 .....	2/22, 2/24
3SE5132-0BJ01 .....	2/14	3SE5162-0EC02 .....	2/34	3SE5230-0AA00-1AG0 .....	2/44
3SE5132-0CA00 .....	2/15	3SE5210-0AA00-1AG0 .....	2/44	3SE5230-1AA00 .....	2/44
3SE5132-0CA00-1AC1 .....	2/15	3SE5210-1AA00 .....	2/44	3SE5230-1AA00-1AG0 .....	2/44
3SE5132-0CA00-1CA0 .....	2/15	3SE5210-1AA00-1AG0 .....	2/44	3SE5230-3AA00 .....	2/44
3SE5132-0CB01 .....	2/13	3SE5210-3AA00 .....	2/44	3SE5230-3AA00-1AG0 .....	2/44
3SE5132-0CC03 .....	2/13	3SE5210-3AA00-1AG0 .....	2/44	3SE5232-0AC05 .....	2/43
3SE5132-0CD05 .....	2/13	3SE5212-0AC05 .....	2/43	3SE5232-0AC05-1CA0 .....	2/43
3SE5132-0CE05 .....	2/13	3SE5212-0AC05-1CA0 .....	2/43	3SE5232-0BC05 .....	2/9, 2/11
3SE5132-0CF05 .....	2/13	3SE5212-0BB01 .....	2/22	3SE5232-0BC05-1CA0 .....	2/9, 2/11
3SE5132-0CJ01 .....	2/14	3SE5212-0BC05 .....	2/22, 2/24	3SE5232-0BD03 .....	2/9
3SE5132-0CJ60 .....	2/14	3SE5212-0BC05-1CA0 .....	2/22, 2/24	3SE5232-0BE10 .....	2/10
3SE5132-0KA00 .....	2/15	3SE5212-0BC05-1DA0 .....	2/67	3SE5232-0BF10 .....	2/10
3SE5132-0KA00-1CA0 .....	2/15	3SE5212-0BD03 .....	2/22	3SE5232-0BK21 .....	2/10
3SE5132-0KB01 .....	2/13	3SE5212-0BE10 .....	2/23	3SE5232-0CC05 .....	2/9, 2/11
3SE5132-0KC03 .....	2/13	3SE5212-0BF10 .....	2/23	3SE5232-0CC05-1AJ0 .....	2/20
3SE5132-0KD05 .....	2/13	3SE5212-0BK21 .....	2/23	3SE5232-0CC05-1CA0 .....	2/9, 2/11
3SE5132-0KE05 .....	2/13	3SE5212-0CB01 .....	2/22	3SE5232-0CK31-1AJ0 .....	2/20
3SE5132-0KJ01 .....	2/14	3SE5212-0CC05 .....	2/22, 2/24	3SE5232-0CK62-1AJ0 .....	2/20
3SE5132-0LA00 .....	2/15	3SE5212-0CC05-1CA0 .....	2/22, 2/24	3SE5232-0FC05 .....	2/9, 2/11
3SE5132-0LA00-1CA0 .....	2/15	3SE5212-0CC05-1DA0 .....	2/67	3SE5232-0FD03 .....	2/9
3SE5132-0LB01 .....	2/13	3SE5212-0CD03 .....	2/22	3SE5232-0GC05 .....	2/9, 2/11
3SE5132-0LC03 .....	2/13	3SE5212-0CE10 .....	2/23	3SE5232-0HC05 .....	2/9, 2/11
3SE5132-0LD05 .....	2/13	3SE5212-0CF10 .....	2/23	3SE5232-0HD03 .....	2/9
3SE5132-0LE05 .....	2/13	3SE5212-0CK21 .....	2/23	3SE5232-0HD10 .....	2/9
3SE5132-0LF05 .....	2/13	3SE5212-0CK60 .....	2/23	3SE5232-0HE10 .....	2/10
3SE5132-0LJ01 .....	2/14	3SE5212-0KB01 .....	2/22	3SE5232-0HF10 .....	2/10
3SE5132-0LJ60 .....	2/14	3SE5212-0KC05 .....	2/22, 2/24	3SE5232-0HK15 .....	2/10
3SE5132-0LU21 .....	2/62	3SE5212-0KC05-1CA0 .....	2/22, 2/24	3SE5232-0HK21 .....	2/10
3SE5132-0LU22 .....	2/62	3SE5212-0KC05-1DA0 .....	2/67	3SE5232-0HK60 .....	2/10
3SE5132-0MA00 .....	2/15	3SE5212-0KD03 .....	2/22	3SE5232-0HU21 .....	2/62
3SE5132-0MA00-1CA0 .....	2/15	3SE5212-0KE10 .....	2/23	3SE5232-0HU22 .....	2/62
3SE5132-0PA00 .....	2/15	3SE5212-0KF10 .....	2/23	3SE5232-0KC05 .....	2/9, 2/11
3SE5132-0PA00-1CA0 .....	2/15	3SE5212-0KK21 .....	2/23	3SE5232-0KC05-1AJ0 .....	2/20
3SE5132-0PB01 .....	2/13	3SE5212-0KK60 .....	2/23	3SE5232-0KC05-1CA0 .....	2/9, 2/11
3SE5132-0PC03 .....	2/13	3SE5212-0LB01 .....	2/22	3SE5232-0KD03 .....	2/9
3SE5132-0PD05 .....	2/13	3SE5212-0LC05 .....	2/22, 2/24	3SE5232-0KD10 .....	2/9
3SE5132-0PE05 .....	2/13	3SE5212-0LC05-1CA0 .....	2/22, 2/24	3SE5232-0KE10 .....	2/10
3SE5132-0PJ01 .....	2/14	3SE5212-0LC05-1DA0 .....	2/67	3SE5232-0KF10 .....	2/10
3SE5132-0QV20 .....	2/48	3SE5212-0LD03 .....	2/22	3SE5232-0KK21 .....	2/10
3SE5132-1KA00 .....	2/15	3SE5212-0LE10 .....	2/23	3SE5232-0LC05 .....	2/9, 2/11
3SE5132-1LA00 .....	2/15	3SE5212-0LF10 .....	2/23	3SE5232-0LC05-1AJ0 .....	2/20
3SE5132-1QV20 .....	2/48	3SE5212-0LK21 .....	2/23	3SE5232-0LC05-1CA0 .....	2/9, 2/11
3SE5132-3KA00 .....	2/15	3SE5212-0LK60 .....	2/23	3SE5232-0LD03 .....	2/9
3SE5132-3LA00 .....	2/15	3SE5212-0LU21 .....	2/63	3SE5232-0LD03-1AH0 .....	2/9





# Appendix

## Order number index

3SE7150-1BD04 .....	2/123
3SE7150-1BF00 .....	2/123
3SE7150-1BH00 .....	2/123
3SE7150-1CD00 .....	2/123
3SE7150-2DD00 .....	2/123
3SE7150-2DD04 .....	2/123
3SE7160-1AE00 .....	2/123
3SE7160-1AE04 .....	2/123
3SE7160-1BD00 .....	2/123
3SE7310-1AE00 .....	2/124
3SE7310-1AE04 .....	2/124
3SE7910-3AA .....	2/125
3SE7910-3AB .....	2/125
3SE7910-3AC .....	2/125
3SE7910-3AH .....	2/125
3SE7920-1AB .....	2/125
3SE7920-1AC .....	2/125
3SE7921-1AA .....	2/125
3SE7921-1AC .....	2/125
3SE7930-1AD .....	2/125
3SE7931-1AB .....	2/125
3SE7931-1AD .....	2/125
3SE7931-1AE .....	2/125
3SE7941-1AC .....	2/125
3SE7942-1AA .....	2/125
3SE7943-1AC .....	2/125
3SE7944-1AC .....	2/125
3SE7950-1AB .....	2/125
3SE7950-1AD .....	2/125

### 3SF1

3SF1114-1KA00-1BA1 .....	2/80
3SF1114-1LA00-1BA1 .....	2/80, 2/90
3SF1114-1QV10-1BA1 .....	2/84
3SF1124-1KA00-1BA2 .....	2/80
3SF1124-1LA00-1BA2 .....	2/80, 2/90
3SF1124-1QV10-1BA2 .....	2/84
3SF1214-1KC05-1BA1 .....	2/78
3SF1214-1LC05-1BA1 .....	2/78, 2/90
3SF1214-1QV40-1BA1 .....	2/84
3SF1234-1KC05-1BA1 .....	2/76
3SF1234-1LC05-1BA1 .....	2/76, 2/89
3SF1234-1QV40-1BA1 .....	2/83
3SF1244-1KC05-1BA2 .....	2/76
3SF1244-1LC05-1BA2 .....	2/76, 2/89
3SF1244-1QV40-1BA2 .....	2/83
3SF1314-1SB11-1BA1 .....	2/88
3SF1314-1SD11-1BA1 .....	2/88
3SF1314-1SE11-1BA1 .....	2/88
3SF1314-1SF11-1BA1 .....	2/88
3SF1314-1SG11-1BA1 .....	2/88
3SF1314-1SJ11-1BA1 .....	2/88
3SF1324-1SB21-1BA1 .....	2/87
3SF1324-1SB21-1BA3 .....	2/87
3SF1324-1SD21-1BA1 .....	2/87
3SF1324-1SD21-1BA3 .....	2/87
3SF1324-1SD21-1BA4 .....	2/87
3SF1324-1SE21-1BA1 .....	2/87
3SF1324-1SF21-1BA1 .....	2/87
3SF1324-1SF21-1BA4 .....	2/87
3SF1324-1SG21-1BA1 .....	2/87
3SF1324-1SG21-1BA4 .....	2/87
3SF1324-1SJ21-1BA1 .....	2/87

### 3SF2

3SF2120-1BF00-0BA1 .....	2/126
3SF2140-1BF00-0BA1 .....	2/126
3SF2150-1BF00-0BA1 .....	2/126

### 3SF5

3SF5402-1AA03 .....	2/110
3SF5402-1AA04 .....	2/110
3SF5402-1AA05 .....	2/110
3SF5402-1AB03 .....	2/110
3SF5402-1AB04 .....	2/110
3SF5402-1AB05 .....	2/110
3SF5500-0BA .....	2/120
3SF5500-0BB .....	2/120
3SF5500-0BC .....	2/120
3SF5500-0CA .....	2/120
3SF5500-0CB .....	2/120
3SF5500-0CC .....	2/120
3SF5500-0DA .....	2/120
3SF5811-0AA08 .....	2/119
3SF5811-0AA10 .....	2/119
3SF5811-0AB08 .....	2/119
3SF5811-2AA08 .....	2/119
3SF5811-2AA10 .....	2/119
3SF5811-2AB08 .....	2/119
3SF5811-2AB10 .....	2/119
3SF5900-0BA .....	2/120
3SF5900-0BB .....	2/120
3SF5900-0CA .....	2/120
3SF5900-0CB .....	2/120
3SF5900-0CC .....	2/120
3SF5900-0CD .....	2/120
3SF5900-0CE .....	2/120
3SF5900-0CF .....	2/120
3SF5900-0CG .....	2/120
3SF5900-0CH .....	2/120
3SF5900-0CJ .....	2/120
3SF5900-0CK .....	2/120
3SF5900-2CC .....	2/120
3SF5900-2CD .....	2/120
3SF5900-2CE .....	2/120
3SF5900-2CF .....	2/120

### 3SX3

3SX3197 .....	2/60
3SX3203 .....	2/60
3SX3206 .....	2/60
3SX3207 .....	2/60
3SX3217 .....	2/52
3SX3218 .....	2/52
3SX3225 .....	2/65
3SX3228 .....	2/52
3SX3231 .....	2/65
3SX3233 .....	2/52
3SX3234 .....	2/52
3SX3235 .....	2/125
3SX3256 .....	2/52
3SX3260 .....	2/92
3SX3261 .....	2/92
3SX3306 .....	2/60

### 3SX5

3SX5100-1F .....	2/59
------------------	------

### 3SX9

3SX9917 .....	2/42
3SX9918 .....	2/42
3SX9926 .....	2/42, 2/51, 2/59

### 3SY3

3SY3027 .....	2/42
3SY3110 .....	2/42
3SY3127 .....	2/42, 2/51, 2/59
3SY3128 .....	2/42, 2/51, 2/59

3SY3131 .....	2/42
3SY3134 .....	2/42
3SY3136 .....	2/42

### 3TK28

3TK2810-0A .....	3/212
3TK2810-0BA01 .....	3/211
3TK2810-0BA02 .....	3/211
3TK2810-0GA01 .....	3/211
3TK2810-0GA02 .....	3/211
3TK2810-0JA01 .....	3/211
3TK2810-0JA02 .....	3/211
3TK2810-1A .....	3/212
3TK2810-1B .....	3/212
3TK2810-1BA41 .....	3/211
3TK2810-1BA42 .....	3/211
3TK2810-1KA41 .....	3/211
3TK2810-1KA42 .....	3/211
3TK2820-0AA00 .....	3/212
3TK2820-1AJ20 .....	3/202
3TK2820-1AL20 .....	3/202
3TK2820-1CB30 .....	3/202
3TK2820-2AJ20 .....	3/202
3TK2820-2AL20 .....	3/202
3TK2820-2CB30 .....	3/202
3TK2821-1CB30 .....	3/202
3TK2821-2CB30 .....	3/202
3TK2822-1CB30 .....	3/202
3TK2822-2CB30 .....	3/202
3TK2823-1CB30 .....	3/202
3TK2823-2CB30 .....	3/202
3TK2824-1AJ20 .....	3/202
3TK2824-1AL20 .....	3/202
3TK2824-1BB40 .....	3/202
3TK2824-1CB30 .....	3/202
3TK2824-2AJ20 .....	3/202
3TK2824-2AL20 .....	3/202
3TK2824-2BB40 .....	3/202
3TK2824-2CB30 .....	3/202
3TK2825-1AB20 .....	3/202
3TK2825-1AJ20 .....	3/202
3TK2825-1AL20 .....	3/202
3TK2825-1BB40 .....	3/202
3TK2825-2AB20 .....	3/202
3TK2825-2AJ20 .....	3/202
3TK2825-2AL20 .....	3/202
3TK2825-2BB40 .....	3/202
3TK2826-0DA00-0HA0 .....	3/212
3TK2826-1BB40 .....	3/202
3TK2826-1BB41 .....	3/202
3TK2826-1BB42 .....	3/202
3TK2826-1BB44 .....	3/202
3TK2826-1CW30 .....	3/202
3TK2826-1CW31 .....	3/202
3TK2826-1CW32 .....	3/202
3TK2826-1CW34 .....	3/202
3TK2826-2BB40 .....	3/202
3TK2826-2BB41 .....	3/202
3TK2826-2BB42 .....	3/202
3TK2826-2BB44 .....	3/202
3TK2826-2CW30 .....	3/202
3TK2826-2CW31 .....	3/202
3TK2826-2CW32 .....	3/202
3TK2826-2CW34 .....	3/202
3TK2827-1AB20 .....	3/202
3TK2827-1AB21 .....	3/202
3TK2827-1AJ20 .....	3/202
3TK2827-1AJ21 .....	3/202

3TK2827-1AL20	3/202	3TK2845-1HB42	3/206	3UF7150-1AA00-0	3/220
3TK2827-1AL21	3/202	3TK2845-1HB44	3/206	3UF7200-1AA00-0	3/220
3TK2827-1BB40	3/202	3TK2845-2DB40	3/206	3UF7210-1AA00-0	3/220
3TK2827-1BB41	3/202	3TK2845-2DB41	3/206	3UF7300-1AB00-0	3/221
3TK2827-2AB20	3/202	3TK2845-2DB42	3/206	3UF7300-1AU00-0	3/221
3TK2827-2AB21	3/202	3TK2845-2DB44	3/206	3UF7310-1AB00-0	3/221
3TK2827-2AJ20	3/202	3TK2845-2EB40	3/206	3UF7310-1AU00-0	3/221
3TK2827-2AJ21	3/202	3TK2845-2EB41	3/206	3UF7320-1AB00-0	3/222
3TK2827-2AL20	3/202	3TK2845-2EB42	3/206	3UF7320-1AU00-0	3/222
3TK2827-2AL21	3/202	3TK2845-2EB44	3/206	3UF7330-1AB00-0	3/222
3TK2827-2BB40	3/202	3TK2845-2FB41	3/206	3UF7330-1AU00-0	3/222
3TK2827-2BB41	3/202	3TK2845-2FB42	3/206	3UF7400-1AA00-0	3/221
3TK2828-1AB20	3/202	3TK2845-2FB44	3/206	3UF7500-1AA00-0	3/221
3TK2828-1AB21	3/202	3TK2845-2GB41	3/206	3UF7700-1AA00-0	3/221
3TK2828-1AJ20	3/202	3TK2845-2GB42	3/206	3UF7900-0AA00-0	3/223
3TK2828-1AJ21	3/202	3TK2845-2GB44	3/206	3UF7910-0AA00-0	3/223
3TK2828-1AL20	3/202	3TK2845-2HB40	3/206	3UF7920-0AA00-0	3/194, 3/223
3TK2828-1AL21	3/202	3TK2845-2HB41	3/206	3UF7922-0AA00-0	3/223
3TK2828-1BB40	3/202	3TK2845-2HB42	3/206	3UF7925-0AA00-0	3/224
3TK2828-1BB41	3/202	3TK2845-2HB44	3/206	3UF7925-0AA01-0	3/224
3TK2828-2AB20	3/202	3TK2850-1AJ20	3/209	3UF7925-0AA02-0	3/224
3TK2828-2AB21	3/202	3TK2850-1AL20	3/209	3UF7930-0AA00-0	3/194, 3/223
3TK2828-2AJ20	3/202	3TK2850-1BB40	3/209	3UF7931-0AA00-0	3/194, 3/223
3TK2828-2AJ21	3/202	3TK2850-2AJ20	3/209	3UF7932-0AA00-0	3/194, 3/223
3TK2828-2AL20	3/202	3TK2850-2AL20	3/209	3UF7932-0BA00-0	3/194, 3/223
3TK2828-2AL21	3/202	3TK2850-2BB40	3/209	3UF7933-0BA00-0	3/194, 3/223
3TK2828-2BB40	3/202	3TK2851-1AJ20	3/209	3UF7935-0AA00-0	3/194, 3/223
3TK2828-2BB41	3/202	3TK2851-1AL20	3/209	3UF7937-0BA00-0	3/194, 3/223
3TK2830-1AJ20	3/203	3TK2851-1BB40	3/209	3UF7940-0AA00-0	3/194, 3/197, 3/223
3TK2830-1AL20	3/203	3TK2851-2AJ20	3/209	3UF7946-0AA00-0	3/173, 3/194, 3/197, 3/223
3TK2830-1CB30	3/203	3TK2851-2AL20	3/209	3UF7950-0AA00-0	3/194, 3/223
3TK2830-2AJ20	3/203	3TK2851-2BB40	3/209	3UF7970-0AA00-0	3/224
3TK2830-2AL20	3/203	3TK2852-1AL20	3/209	3UF7970-0AA01-0	3/224
3TK2830-2CB30	3/203	3TK2852-1BB40	3/209	3UF7970-0AA02-0	3/224
3TK2834-1AB20	3/203	3TK2852-2AL20	3/209	3UF7982-0AA00-0	3/226
3TK2834-1AJ20	3/203	3TK2852-2BB40	3/209	3UF7982-0AA01-0	3/226
3TK2834-1AL20	3/203	3TK2853-1BB40	3/209	3UF7982-0AA02-0	3/226
3TK2834-1BB40	3/203	3TK2853-2BB40	3/209	3UF7982-0AA10-0	3/226
3TK2834-2AB20	3/203	3TK2856-1BB40	3/209	3UF7982-0AA11-0	3/226
3TK2834-2AJ20	3/203	3TK2856-2BB40	3/209	3UF7982-0AA13-0	3/226
3TK2834-2AL20	3/203	3TK2857-1BB41	3/209		
3TK2834-2BB40	3/203	3TK2857-1BB42	3/209	<b>3ZS3</b>	
3TK2840-1BB40	3/206	3TK2857-1BB44	3/209	3ZS1310-4CC10-0YA5	4/30
3TK2840-2BB40	3/206	3TK2857-2BB41	3/209	3ZS1310-4CE10-0YB5	4/30
3TK2841-1BB40	3/206	3TK2857-2BB42	3/209	3ZS1310-5CC10-0YA5	4/31
3TK2841-2BB40	3/206	3TK2857-2BB44	3/209	3ZS1310-5CC10-0YD5	4/31
3TK2842-1BB41	3/206			3ZS1310-5CC10-0YE5	4/31
3TK2842-1BB42	3/206	<b>3UF1</b>		3ZS1310-5CC10-0YL5	4/31
3TK2842-1BB44	3/206	3UF1900-1KA00	3/224	3ZS1310-5CE10-0YB5	4/31
3TK2842-2BB41	3/206	3UF1900-1KB00	3/224	3ZS1310-6CC10-0YA5	4/31
3TK2842-2BB42	3/206			3ZS1310-6CC10-0YD5	4/31
3TK2842-2BB44	3/206	<b>3UF7</b>		3ZS1310-6CC10-0YE5	4/31
3TK2845-1DB40	3/206	3UF7000-1AB00-0	3/220	3ZS1310-6CC10-0YL5	4/31
3TK2845-1DB41	3/206	3UF7000-1AU00-0	3/220	3ZS1310-6CE10-0YB5	4/31
3TK2845-1DB42	3/206	3UF7010-1AB00-0	3/220	3ZS1312-4CC10-0YA5	3/225
3TK2845-1DB44	3/206	3UF7010-1AU00-0	3/220	3ZS1312-4CE10-0YB5	3/225
3TK2845-1EB40	3/206	3UF7100-1AA00-0	3/220	3ZS1312-5CC10-0YA5	3/225
3TK2845-1EB41	3/206	3UF7101-1AA00-0	3/220	3ZS1312-5CC10-0YD5	3/225
3TK2845-1EB42	3/206	3UF7102-1AA00-0	3/220	3ZS1312-5CC10-0YE5	3/225
3TK2845-1EB44	3/206	3UF7103-1AA00-0	3/220	3ZS1312-5CC10-0YL5	3/225
3TK2845-1FB41	3/206	3UF7103-1BA00-0	3/220	3ZS1312-5CE10-0YB5	3/225
3TK2845-1FB42	3/206	3UF7104-1BA00-0	3/220	3ZS1312-6CC10-0YA5	3/225
3TK2845-1FB44	3/206	3UF7110-1AA00-0	3/220	3ZS1312-6CC10-0YD5	3/225
3TK2845-1GB41	3/206	3UF7111-1AA00-0	3/220	3ZS1312-6CC10-0YE5	3/225
3TK2845-1GB42	3/206	3UF7112-1AA00-0	3/220	3ZS1312-6CC10-0YL5	3/225
3TK2845-1GB44	3/206	3UF7113-1AA00-0	3/220	3ZS1312-6CE10-0YB5	3/225
3TK2845-1HB40	3/206	3UF7113-1BA00-0	3/220	3ZS1314-4CC10-0YA5	3/197
3TK2845-1HB41	3/206	3UF7114-1BA00-0	3/220	3ZS1314-4CE10-0YB5	3/197

# Appendix

## Order number index

3ZS1314-5CC10-0YA5.....	3/197	6AV6691-1DM01-2AE0.....	2/139	6ES7193-4LB10-0AA0.....	4/23
3ZS1314-5CC10-0YD5.....	3/197	6AV6691-1DQ01-2AA0.....	2/139	6ES7193-4LB20-0AA0.....	3/118
3ZS1314-5CC10-0YL5.....	3/197	6AV6691-1DQ01-2AB0.....	2/139	6ES7193-4LC10-0AA0.....	4/23
3ZS1314-5CE10-0YB5.....	3/197	6AV6691-1DQ01-2AC0.....	2/139	6ES7193-4LC20-0AA0.....	3/118
<b>6AG1</b>					
6AG1138-4FA04-2AB0.....	3/113	6AV6691-1DQ01-2AD0.....	2/139	6ES7193-4LD10-0AA0.....	4/23
6AG1138-4FB03-2AB0.....	3/113	6AV6691-1DQ01-2AE0.....	2/139	6ES7193-4LD20-0AA0.....	3/118
6AG1138-4HA00-7AB0.....	3/105	<b>6ED1</b>			
6AG1151-7FA20-2AB0.....	3/97	6ED1057-1AA00-0BA0.....	4/21, 4/31	6ES7193-4LF10-0AA0.....	4/23
6AG1151-8FB00-2AB0.....	3/104	<b>6ES5</b>			
6AG1153-2BA02-7XB0.....	3/145	6ES5710-8MA11.....	3/97, 3/104	6ES7193-4LF20-0AA0.....	3/118
6AG1195-7HA00-2XA0.....	3/145	6ES5710-8MA21.....	3/97, 3/104	6ES7193-4LG10-0AA0.....	4/23
6AG1195-7HB00-7XA0.....	3/145	6ES5710-8MA31.....	3/97, 3/104	6ES7193-4LG20-0AA0.....	3/118
6AG1195-7HC00-2XA0.....	3/145	6ES5710-8MA41.....	3/97, 3/104	6ES7193-4LH20-0AA0.....	3/118
6AG1195-7HD10-2XA0.....	3/145	<b>6ES7</b>			
6AG1195-7KF00-2XA0.....	3/159	6ES7138-4CF03-0AB0.....	3/107, 3/109	6ES7194-1AB01-0XA0.....	4/44
6AG1197-1LA11-4XA0.....	3/82	6ES7138-4CF42-0AB0.....	3/107, 3/109	6ES7194-1KA01-0XA0.....	3/165
6AG1315-2FJ14-2AB0.....	3/21	6ES7138-4FA04-0AB0.....	3/113	6ES7194-1KB00-0XA0.....	3/165
6AG1315-2FJ14-2AY0.....	3/21	6ES7138-4FB03-0AB0.....	3/111, 3/113	6ES7194-1LA01-0AA0.....	4/44
6AG1315-6FF04-2AB0.....	3/8	6ES7138-4FC01-0AB0.....	3/113	6ES7194-1LB01-0AA0.....	4/44
6AG1317-2FK14-2AB0.....	3/29	6ES7138-4FR00-0AA0.....	3/115, 3/116	6ES7194-1LC01-0AA0.....	4/44
6AG1317-2FK14-2AY0.....	3/29	6ES7138-4HA00-0AB0.....	3/105	6ES7194-1LD01-0AA0.....	4/44
6AG1317-6FF03-2AB0.....	3/14	6ES7142-3BF00-0XA0.....	3/162, 3/165	6ES7194-3AA00-0AA0.....	3/164, 3/165
6AG1317-6FF03-2AY0.....	3/14	6ES7142-3BH00-0XA0.....	3/162, 3/165	6ES7194-3AA00-0BA0.....	3/164, 3/165
6AG1326-1BK02-2AB0.....	3/151	6ES7143-3BH00-0XA0.....	3/163, 3/165	6ES7194-3JA00-0AA03/123, 3/125, 3/137, 3/165	3/122
6AG1326-1RF00-4AB0.....	3/151	66ES7143-3BH10-0XA0.....	3/163, 3/165	6ES7194-4AA00-0AA0.....	3/122
6AG1326-2BF10-2AB0.....	3/155	6ES7148-3FA00-0XB0.....	3/160, 3/165	6ES7194-4AC00-0AA0.....	3/122
6AG1326-2BF41-2AB0.....	3/155	6ES7148-4FA00-0AB0.....	3/138	6ES7194-4AD00-0AA0.....	3/122
6AG1326-2BF41-2AY0.....	3/155	6ES7148-4FC00-0AB0.....	3/138	6ES7194-4AF00-0AA0.....	3/125
6AG1336-4GE00-0AA0.....	3/157	6ES7148-4FS00-0AB0.....	3/138	6ES7194-4AG00-0AA0.....	3/125
6AG1412-3HJ14-4AB0.....	3/65	6ES7148-4FS00-0AB0.....	4/36	6ES7194-4AN00-0AA0.....	3/136
6AG1414-4MH14-4AB0.....	3/71	6ES7151-1BA02-0AB0.....	3/109	6ES7194-4DA00-0AA0.....	3/138
6AG1417-4HT14-4AB0.....	3/77	6ES7151-1BA02-0AB0.....	3/113, 3/116	6ES7194-4DA00-0AA0.....	4/36
6AG1654-7HY00-7XA0.....	3/82	6ES7151-3BA23-0AB0.....	3/109, 3/113, 3/116	6ES7194-4DC00-0AA0.....	3/138
6AG1960-1AA04-4XA0.....	3/79	6ES7151-3BB23-0AB0.....	3/109, 3/113, 3/116	6ES7194-4DD00-0AA0.....	3/138
<b>6AV6</b>					
6AV6645-0DB01-0AX0.....	2/138	6ES7151-7FA20-0AB0.....	3/94, 3/97	6ES7194-4GA00-0AA0.....	3/123, 3/126, 3/129
6AV6645-0DC01-0AX0.....	2/138	6ES7151-8FB01-0AB0.....	3/99, 3/104	6ES7194-4GA20-0AA0.....	3/123, 3/126, 3/129
6AV6645-0DD01-0AX0.....	2/138	6ES7153-2AR03-0XA0.....	3/145	6ES7194-4GA60-0AA0.....	3/123, 3/126, 3/129
6AV6645-0DE01-0AX0.....	2/138	6ES7153-2BA02-0XB0.....	3/81, 3/144, 3/145	6ES7194-4GB00-0AA0.....	3/123, 3/126, 3/129
6AV6645-0EF01-0AX1.....	2/138	6ES7153-2BA82-0XB0.....	3/144, 3/145	6ES7194-4GB20-0AA0.....	4/40
6AV6645-0FD01-0AX0.....	2/138	6ES7153-4BA00-0XB0.....	3/148, 3/149	6ES7194-4GB60-0AA0.....	3/123, 3/126, 3/129
6AV6645-0FE01-0AX0.....	2/138	6ES7154-2AA01-0AB0.....	3/121, 3/122, 3/138	6ES7194-4GC20-0AA0.....	3/123, 3/126, 3/129
6AV6645-0GB01-0AX0.....	2/138	6ES7154-4AB10-0AB0.....	3/124, 3/125, 3/138	6ES7194-4GC60-0AA0.....	3/123, 3/126, 3/129
6AV6645-0GC01-0AX0.....	2/138	6ES7154-6AB00-0AB0.....	3/128	6ES7194-4GC70-0AA0.....	3/123, 3/126, 3/129
6AV6651-5GA01-0AA1.....	2/138	6ES7154-6AB50-0AB0.....	3/128	6ES7194-4GD00-0AA0.....	3/123, 3/126, 3/129
6AV6651-5HA01-0AA1.....	2/138	6ES7154-8FB01-0AB0.....	3/131, 3/136	6ES7194-4GD00-0AA0.....	4/40
6AV6671-5CA00-0AX1.....	2/138	6ES7193-1BH00-0XA0.....	3/152, 3/155, 3/157	6ES7194-4GD10-0AA0.....	3/123, 3/126, 3/129
6AV6671-5CE00-0AX0.....	2/138	6ES7193-1BL00-0XA0.....	3/152, 3/155, 3/157	6ES7194-4GD10-0AA0.....	4/40
6AV6671-5CL00-0AX0.....	2/138	6ES7193-4BA00-0AA0.....	3/104, 3/105	6ES7194-4GD20-0AA0.....	3/123, 3/126, 3/129
6AV6671-5CM00-0AX0.....	2/138	6ES7193-4BB00-0AA0.....	3/104, 3/105	6ES7194-4GD20-0AA0.....	4/40
6AV6671-5CN00-0AX1.....	2/138	6ES7193-4BD00-0AA0.....	3/104, 3/105	6ES7194-4HB00-0AA0.....	3/123, 3/126, 3/129
6AV6691-1AB01-3AA0.....	2/139	6ES7193-4BH00-0AA0.....	3/104, 3/105	6ES7194-4JD50-0AA0.....	3/126
6AV6691-1AB01-3AB0.....	2/139	6ES7193-4CC20-0AA0.....	3/118	6ES7194-4JD60-0AA0.....	3/137
6AV6691-1AB01-3AC0.....	2/139	6ES7193-4CC30-0AA0.....	3/118	6ES7194-4MA00-0AA0.....	3/128
6AV6691-1AB01-3AD0.....	2/139	6ES7193-4CD20-0AA0.....	3/118	6ES7194-6KA00-0XA0.....	3/166
6AV6691-1AB01-3AE0.....	2/139	6ES7193-4CD30-0AA0.....	3/118	6ES7195-1GA00-0XA0.....	3/82, 3/146, 3/149, 3/152, 3/155, 3/157
6AV6691-1CA01-3AA0.....	2/139	6ES7193-4CE00-0AA0.....	3/118	6ES7195-1GC00-0XA0.....	3/146, 3/149, 3/152, 3/155, 3/157
6AV6691-1CA01-3AB0.....	2/139	6ES7193-4CE10-0AA0.....	3/118	6ES7195-1GF30-0XA0.....	3/82, 3/146, 3/149, 3/152, 3/155, 3/157
6AV6691-1CA01-3AC0.....	2/139	6ES7193-4CF40-0AA0.....	3/118	6ES7195-1GG30-0XA0.....	3/146, 3/149, 3/152, 3/155, 3/157
6AV6691-1CA01-3AC0.....	2/139	6ES7193-4CF50-0AA0.....	3/118	66ES7195-7HA00-0XA0.....	3/145, 3/149
6AV6691-1CA01-3AD0.....	2/139	6ES7193-4CG20-0AA0.....	3/118	6ES7195-7HB00-0XA0.....	3/145, 3/149, 3/155, 3/157
6AV6691-1CA01-3AE0.....	2/139	6ES7193-4CG30-0AA0.....	3/118	6ES7195-7HC00-0XA0.....	3/145, 3/149, 3/152, 3/155
6AV6691-1DM01-2AA0.....	2/139	6ES7193-4CK20-0AA0.....	3/109, 3/118	6ES7195-7HD10-0XA0.....	3/145
6AV6691-1DM01-2AB0.....	2/139	6ES7193-4CK30-0AA0.....	3/109, 3/118		
6AV6691-1DM01-2AC0.....	2/139	6ES7193-4JA00-0AA0.....	3/97, 3/104		
6AV6691-1DM01-2AD0.....	2/139	6ES7193-4LA10-0AA0.....	4/23		
		6ES7193-4LA20-0AA0.....	3/118		

6ES7195-7HG00-0XA0	3/159	6ES7398-8FA10-8CA0	3/8, 3/14, 3/21, 3/29, 3/38, 3/45, 3/152, 3/155, 3/158	6ES7952-1AP00-0AA0	3/48, 3/58, 3/65, 3/71, 3/77
6ES7195-7KF00-0XA0	3/159	6ES7398-8FA10-8DA0	3/8, 3/14, 3/21, 3/29, 3/38, 3/45, 3/152, 3/155, 3/158	6ES7952-1AS00-0AA0	3/48, 3/58, 3/65, 3/71, 3/77
6ES7197-1LA04-0XA0	3/82	6ES7398-8FA10-8EA0	3/8, 3/14, 3/21, 3/29, 3/38, 3/45, 3/152, 3/155, 3/158	6ES7952-1AY00-0AA0	3/48, 3/58, 3/65, 3/71, 3/77
6ES7197-1LA11-0XA0	3/82	6ES7400-0HR00-4AB0	3/65	6ES7952-1KK00-0AA0	3/48, 3/59, 3/65, 3/71, 3/77
6ES7197-1LB00-0XA0	3/81	6ES7400-0HR50-4AB0	3/65	6ES7952-1KL00-0AA0	3/48, 3/59, 3/65, 3/71, 3/77
6ES7198-8GA00-8AA0	3/166	6ES7412-3HJ14-0AB0	3/65	6ES7952-1KM00-0AA0	3/48, 3/59, 3/65, 3/71, 3/77
6ES7198-8GA00-8BA0	3/166	6ES7414-3FM06-0AB0	3/48	6ES7952-1KP00-0AA0	3/48, 3/59, 3/65, 3/71, 3/77
6ES7198-8GA00-8CA0	3/166	6ES7414-4HM14-0AB0	3/71	6ES7952-1KS00-0AA0	3/48, 3/59, 3/65, 3/71, 3/77
6ES7307-1EA01-0AA0	3/152, 3/155, 3/158	6ES7416-2FN05-0AB0	3/58	6ES7952-1KT00-0AA0	3/48, 3/59, 3/65, 3/71, 3/77
6ES7315-2FJ14-0AB0	3/16, 3/21	6ES7416-3FR05-0AB0	3/58	6ES7952-1KY00-0AA0	3/48, 3/59, 3/65, 3/71, 3/77
6ES7315-6FF04-0AB0	3/5, 3/8	6ES7416-3FS06-0AB0	3/58	6ES7953-8LF20-0AA0	3/8, 3/14, 3/21, 3/29, 3/38, 3/97, 3/104, 3/129, 3/136, 3/149
6ES7317-2FK14-0AB0	3/25, 3/29	6ES7417-4HT10-0AB0	3/77	6ES7953-8LG20-0AA0	3/8, 3/14, 3/21, 3/29, 3/38, 3/97, 3/104, 3/129, 3/136
6ES7317-6FF03-0AB0	3/10, 3/14	6ES7498-8AA00-8AB0	3/49, 3/59, 3/65, 3/71, 3/78	6ES7953-8LJ20-0AA0	3/8, 3/14, 3/21, 3/29, 3/38, 3/97, 3/104, 3/129, 3/136
6ES7317-6TF14-0AB0	3/42, 3/45	6ES7498-8AA00-8BB0	3/49, 3/59, 3/65, 3/71, 3/78	6ES7953-8LL20-0AA0	3/8, 3/14, 3/21, 3/29, 3/38, 3/97, 3/104, 3/129, 3/136
6ES7318-3FL01-0AB0	3/38	6ES7498-8AA05-8AA0	3/49, 3/59	6ES7953-8LM20-0AA0	3/8, 3/14, 3/21, 3/29, 3/38, 3/97, 3/104, 3/129, 3/136
6ES7326-1BK02-0AB0	3/150, 3/151	6ES7498-8AA05-8AN0	3/49, 3/59	6ES7960-1AA04-0XA0	3/79
6ES7326-1RF00-0AB0	3/150, 3/151	6ES7498-8AA05-8BA0	3/49, 3/59	6ES7960-1AA04-5AA0	3/79
6ES7326-2BF10-0AB0	3/155	6ES7498-8AA05-8BAA0	3/49, 3/59	6ES7960-1AA04-5BA0	3/79
6ES7326-2BF41-0AB0	3/155	6ES7498-8AA05-8BN0	3/49, 3/59	6ES7960-1AA04-5KA0	3/79
6ES7336-4GE00-0AB0	3/157	6ES7654-7HY00-0XA0	3/82	6ES7960-1AB04-0XA0	3/79
6ES7390-1AB60-0AA0	3/146, 3/149	6ES7671-1RC08-0YA0	3/92	6ES7964-2AA04-0AB0	3/49, 3/59
6ES7390-1AE80-0AA0	3/146, 3/149	6ES7671-1RC08-0YE0	3/92	6ES7972-0AA01-0XA0	3/8, 3/14, 3/21, 3/29, 3/38, 3/46, 3/49, 3/59, 3/65, 3/71, 3/78, 3/152, 3/155, 3/157
6ES7390-1AF30-0AA0	3/146, 3/149	6ES7792-0AA00-0XA0	3/97, 3/104	6ES7972-0BA12-0XA0	3/8, 3/14, 3/21, 3/29, 3/38, 3/46, 3/49, 3/59, 3/65, 3/71, 3/78, 3/152, 3/155, 3/157
6ES7390-1AJ30-0AA0	3/146, 3/149	6ES7833-1CC00-6YX0	3/65, 3/71, 3/77, 3/86	6ES7972-0BA41-0XA0	4/86, 4/105, 4/112
6ES7390-1BC00-0AA0	3/146, 3/149	6ES7833-1CC01-0YA5	3/78	6ES7972-0BA42-0XA0	3/49, 3/59, 3/66, 3/72, 3/78
6ES7391-1AA00-0AA0	3/8, 3/14, 3/21, 3/29, 3/38, 3/45	6ES7833-1CC01-0YE5	3/78	6ES7972-0BA52-0XA0	3/8, 3/14, 3/21, 3/29, 3/38, 3/46, 3/49, 3/59, 3/66, 3/72, 3/78, 3/145, 3/152, 3/155, 3/157
6ES7392-1AJ00-0AA0	3/158, 3/178	6ES7833-1CC02-0YA5	3/65, 3/71, 3/77, 3/86	6ES7972-0BA52-0XB0	3/8, 3/14, 3/21, 3/29, 3/38, 3/46, 3/49, 3/59, 3/66, 3/72, 3/78, 3/145, 3/152, 3/155, 3/157
6ES7392-1AJ00-1AB0	3/158	6ES7833-1CC02-0YE5	3/65, 3/71, 3/77, 3/86	6ES7972-0BA60-0XA0	3/181, 3/183
6ES7392-1AM00-0AA0	3/45, 3/152, 3/155	6ES7833-1FC00-0YX2	3/8, 3/14, 3/21, 3/29, 3/38, 3/48, 3/58, 3/83, 3/97, 3/104, 3/109, 3/113, 3/116, 3/136, 3/151, 3/155, 3/157, 3/166	6ES7972-0BB12-0XA0	3/8, 3/14, 3/21, 3/29, 3/38, 3/46, 3/49, 3/59, 3/65, 3/71, 3/78, 3/152, 3/155, 3/157
6ES7392-1AM00-1AB0	3/45, 3/152, 3/155	6ES7833-1FC02-0YA5	3/8, 3/14, 3/21, 3/29, 3/38, 3/48, 3/58, 3/83, 3/97, 3/104, 3/109, 3/113, 3/116, 3/136, 3/151, 3/155, 3/157, 3/166	6ES7972-0BB41-0XA0	4/86, 4/105, 4/112
6ES7392-1BJ00-0AA0	3/158, 3/178	6ES7833-1FC02-0YE5	3/8, 3/14, 3/21, 3/29, 3/38, 3/48, 3/58, 3/83, 3/97, 3/104, 3/109, 3/113, 3/116, 3/136, 3/151, 3/155, 3/157, 3/166	6ES7972-0BB42-0XA0	3/49, 3/59, 3/66, 3/72, 3/78
6ES7392-1BJ00-1AB0	3/158	6ES7833-1SM02-0YA5	3/88	6ES7972-0BB52-0XA0	3/8, 3/14, 3/21, 3/29, 3/38, 3/46, 3/49, 3/59, 3/66, 3/72, 3/78, 3/145, 3/152, 3/155, 3/157
6ES7392-1BM01-0AA0	3/45, 3/152, 3/155	6ES7833-1SM02-0YE5	3/88	6ES7972-0BB52-0XB0	3/8, 3/14, 3/21, 3/29, 3/38, 3/46, 3/49, 3/59, 3/66, 3/72, 3/78, 3/145, 3/152, 3/155, 3/157
6ES7392-1BM01-1AB0	3/45, 3/152, 3/155	6ES7833-1SM42-0YA5	3/88	6ES7972-0BB60-0XA0	3/181, 3/183
6ES7392-1CJ00-0AA0	3/158	6ES7833-1SM62-0YA5	3/88		
6ES7392-1CM00-0AA0	3/45, 3/152, 3/155	6ES7833-1SM62-0YE5	3/88		
6ES7392-2AX00-0AA0	3/46	6ES7862-0AC01-0YA0	3/90		
6ES7392-2AX10-0AA0	3/46, 3/158	6ES7862-0AC01-0YA1	3/90		
6ES7392-2BX00-0AA0	3/46	6ES7864-1CC42-0YA5	3/45		
6ES7392-2BX10-0AA0	3/46, 3/158	6ES7901-0BF00-0AA0	3/8, 3/14, 3/21, 3/29, 3/38, 3/46, 3/49, 3/59, 3/65, 3/71, 3/78		
6ES7392-2CX00-0AA0	3/46	6ES7901-4BD00-0XA0	3/152, 3/155, 3/157		
6ES7392-2CX10-0AA0	3/46, 3/158	6ES7912-0AA00-0AA0	3/8, 3/14, 3/21, 3/29, 3/38, 3/45, 3/49, 3/59, 3/65, 3/71, 3/78		
6ES7392-2DX00-0AA0	3/46	6ES7952-0AF00-0AA0	3/48, 3/58		
6ES7392-2DX10-0AA0	3/46, 3/158	6ES7952-0KF00-0AA0	3/48, 3/58		
6ES7392-2XX00-0AA0	3/46	6ES7952-0KH00-0AA0	3/48, 3/58		
6ES7392-2XX20-0AA0	3/152, 3/155, 3/158	6ES7952-1AH00-0AA0	3/48, 3/58		
6ES7392-2XY00-0AA0	3/46	6ES7952-1AK00-0AA0	3/48, 3/58, 3/65, 3/71, 3/77		
6ES7392-2XY20-0AA0	3/152, 3/155, 3/158	6ES7952-1AL00-0AA0	3/48, 3/58, 3/65, 3/71, 3/77		
6ES7393-4AA10-0AA0	3/152, 3/155, 3/158	6ES7952-1AM00-0AA0	3/48, 3/58, 3/65, 3/71, 3/77		
6ES7398-8EA00-8AA0	3/8, 3/14, 3/21, 3/29, 3/38, 3/46, 3/49, 3/59, 3/65, 3/71, 3/78				
6ES7398-8EA00-8BA0	3/8, 3/14, 3/21, 3/29, 3/38, 3/46, 3/49, 3/59, 3/65, 3/71, 3/78				
6ES7398-8EA00-8CA0	3/8, 3/14, 3/21, 3/29, 3/38, 3/46, 3/49, 3/59, 3/65, 3/71, 3/78				
6ES7398-8EA00-8DA0	3/8, 3/14, 3/21, 3/29, 3/38, 3/46, 3/49, 3/59, 3/65, 3/71, 3/78				
6ES7398-8EA00-8EA0	3/8, 3/14, 3/21, 3/29, 3/38, 3/46, 3/49, 3/59, 3/65, 3/71, 3/78				
6ES7398-8FA10-8AA0	3/8, 3/14, 3/21, 3/29, 3/38, 3/45, 3/152, 3/155, 3/158				
6ES7398-8FA10-8BA0	3/8, 3/14, 3/21, 3/29, 3/38, 3/45, 3/152, 3/155, 3/158				

# Appendix

## Order number index

6ES7972-0CB20-0XA0	3/8, 3/14, 3/21, 3/29, 3/38, 3/46
6ES7991-0CD01-0YX0	3/123
6ES7998-8XC01-8YE0	3/8, 3/14, 3/21, 3/29, 3/38, 3/45, 3/49, 3/59, 3/65, 3/71, 3/78, 3/90, 3/109, 3/113, 3/116, 3/123, 3/126, 3/129, 3/146, 3/149, 3/152, 3/155, 3/158, 3/166
6ES7998-8XC01-8YE2	3/8, 3/14, 3/21, 3/29, 3/38, 3/45, 3/49, 3/59, 3/65, 3/71, 3/78, 3/90, 3/109, 3/113, 3/116, 3/123, 3/126, 3/129, 3/146, 3/149, 3/152, 3/155, 3/158, 3/166

### 6FC5

6FC5250-0AG00-0AA0	4/121
6FC5250-0AG10-0AA0	4/121
6FC5250-0AG11-0AA0	4/121
6FC5250-0AG12-0AA0	4/121
6FC5800-0AC50-0AA0	4/122
6FC5800-0AC60-0YB0	4/121
6FC5800-0AC70-0YB0	4/121
6FC5800-0AM63-0YB0	4/121
6FC5800-0AM64-0YB0	4/121

### 6GK1

6GK1160-4AU00	3/92
6GK1161-6AA01	3/92
6GK1411-2AB10	3/189
6GK1411-2AB20	3/189
6GK1415-2AA10	3/183
6GK1415-2BA10	3/181
6GK1415-2BA20	3/181
6GK1500-0EA02	3/8, 3/14, 3/21, 3/29, 3/38, 3/46, 3/49, 3/59, 3/66, 3/72, 3/78
6GK1560-3AU00	3/92
6GK1561-1AA01	3/92
6GK1561-3AA01	3/92
6GK1562-1AA00	3/92
6GK1562-1AM00	3/92
6GK1562-3AA00	3/92
6GK1900-0AB00	3/181, 3/189
6GK1900-0MB00-6AA0	3/125
6GK1900-0NB00-6AA0	3/125
6GK1901-0DB20-6AA0	3/137
6GK1901-0DB20-6AA8	3/137
6GK1901-0DM20-2AA5	3/126, 3/137
6GK1901-1BB10-2AA0	3/22, 3/30, 3/39, 3/49, 3/59, 3/104, 3/129, 3/136, 3/149
6GK1901-1BB10-2AA0	4/108
6GK1901-1BB10-2AB0	3/22, 3/30, 3/39, 3/49, 3/59, 3/104, 3/129, 3/136, 3/149
6GK1901-1BB10-2AB0	4/108
6GK1901-1BB10-2AE0	3/22, 3/30, 3/39, 3/49, 3/59, 3/104, 3/136, 3/149
6GK1901-1BB10-6AA0	3/125
6GK1901-1BB20-2AA0	3/129, 3/136, 3/181, 3/189
6GK1901-1BB20-2AB0	3/129, 3/136, 3/181, 3/189
6GK1901-1BB20-2AE0	3/181, 3/189
6GK1901-1BB30-0AA0	3/22, 3/30, 3/39
6GK1901-1BB30-0AB0	3/22, 3/30, 3/39
6GK1901-1BB30-0AE0	3/22, 3/30, 3/39
6GK1901-1GA00	3/104, 3/136, 3/149
6GK1901-1GA00	4/108
6GK1905-0CA00	3/122

6GK1905-0CB00	3/122, 3/165
6GK1905-0CC00	3/122, 3/165
6GK1905-0CD00	3/122, 3/165
6GK1905-0DA00	3/165
6GK1905-0DA10	3/165
6GK1905-0EA00	3/123, 3/137, 3/165
6GK1905-0EB00	3/123, 3/137, 3/165
6GK1905-0EC00	3/123, 3/137, 3/165
6GK1905-0ED00	3/137
6GK1905-0FA00	3/123, 3/125, 3/137, 3/165
6GK1905-0FB00	3/123, 3/125, 3/129, 3/137, 3/165
6GK1905-6AA00	3/181, 3/183
6GK1907-0AB10-6AA0	3/126
6GK1907-0AB10-6AA0	3/126

### 6GK5

6GK5204-2BB10-2AA3	3/22, 3/29, 3/38, 3/49, 3/59
6GK5208-0HA00-2AA6	3/136
6GK5784-1AA30	2/139
6GK5786	2/139
6GK5786-1BA60-2AA0	2/138
6GK5786-1BA60-2AB0	2/138
6GK5786-2BA60-6AA0	2/138
6GK5786-2BA60-6AB0	2/138
6GK5788	2/139
6GK5791-2AC00-0AA0	2/139
6GK5791-2DC00-0AA0	2/139
6GK5792-4DN00-0AA6	3/128
6GK5792-6MN00-0AA6	3/128
6GK5793-4MN00-0AA6	3/128
6GK5793-6MN00-0AA6	3/128
6GK5795-1TR10-0AA6	3/128

### 6GK7

6GK7243-2AX01-0XA0	3/177
6GK7343-2AH01-0XA0	3/178
6GK7343-2AH11-0XA0	3/178
6GK7377-1AA00-0AA0	3/22, 3/30, 3/39

### 6SE6

6SE6400-2FA00-6AD0	4/93
6SE6400-3CC00-2AD3	4/93
6SE6400-3CC00-4AB3	4/93
6SE6400-3CC00-4AD3	4/93
6SE6400-3CC00-6AD3	4/93
6SE6400-3CC01-0AB3	4/93
6SE6400-3CC11-2FD0	4/93
6SE6400-3CC11-7FD0	4/93
6SE6400-4BC05-0AA0	4/94
6SE6400-4BD11-0AA0	4/94
6SE6400-4BD16-5CA0	4/94
6SE6400-4BD21-2DA0	4/94
6SE6400-4BD22-2EA0	4/94
6SE6400-4BD24-0FA0	4/94

### 6SL3

6SL3040-0JA00-0AA0	4/86
6SL3040-0JA02-0AA0	4/86
6SL3040-0LA00-0AA1	4/105
6SL3040-0LA01-0AA1	4/108
6SL3040-1MA00-0AA0	4/112
6SL3054-0CG00-1AA0	4/109
6SL3054-0CG00-1AA0-ZF01	4/109
6SL3054-0ED00-1BA0-ZF0	4/113
6SL3054-0ED00-1BA0	4/113
6SL3054-0ED01-1BA0	4/113
6SL3054-4AG00-0AA0	4/86
6SL3054-4EB00-0AA0	4/86

6SL3054-4EB00-0AA0-ZF01	4/86
6SL3055-0AA00-3BA0	4/116
6SL3055-0AA00-4BA0	4/96
6SL3064-1BB00-0AA0	4/112
6SL3066-4CA00-0AA0	4/105, 4/108, 4/112, 4/116
6SL3070-0AA00-0AG0	4/64
6SL3072-0AA00-0AG0	4/65, 4/74, 4/86, 4/105, 4/108, 4/112
6SL3074-0AA01-0AA0	4/113
6SL3074-0AA10-0AA0	4/86, 4/109, 4/113
6SL3201-0BE12-0AA0	4/94
6SL3203-0CD21-0AA0	4/93
6SL3203-0CD21-4AA0	4/93
6SL3203-0CD22-2AA0	4/93
6SL3203-0CD23-5AA0	4/93
6SL3203-0CD25-3AA0	4/93
6SL3203-0CJ24-5AA0	4/93
6SL3203-0CJ28-6AA0	4/93
6SL3210-1SB11-0AA0	4/91
6SL3210-1SB11-0UA0	4/91
6SL3210-1SB12-3AA0	4/91
6SL3210-1SB12-3UA0	4/91
6SL3210-1SB14-0AA0	4/91
6SL3210-1SB14-0UA0	4/91
6SL3210-1SE11-3UA0	4/91
6SL3210-1SE11-7UA0	4/91
6SL3210-1SE12-2UA0	4/91
6SL3210-1SE13-1UA0	4/91
6SL3210-1SE14-1UA0	4/91
6SL3210-1SE16-0AA0	4/91
6SL3210-1SE16-0UA0	4/91
6SL3210-1SE17-7AA0	4/91
6SL3210-1SE17-7UA0	4/91
6SL3210-1SE21-0AA0	4/91
6SL3210-1SE21-0UA0	4/91
6SL3210-1SE21-8AA0	4/91
6SL3210-1SE21-8UA0	4/91
6SL3210-1SE22-5AA0	4/91
6SL3210-1SE22-5UA0	4/91
6SL3210-1SE23-2AA0	4/91
6SL3210-1SE23-2UA0	4/91
6SL3210-1SE23-8AA0	4/91
6SL3210-1SE23-8UA0	4/91
6SL3210-1SE24-5AA0	4/91
6SL3210-1SE24-5UA0	4/91
6SL3210-1SE26-0AA0	4/91
6SL3210-1SE26-0UA0	4/91
6SL3210-1SE27-5AA0	4/91
6SL3210-1SE27-5UA0	4/91
6SL3210-1SE31-0AA0	4/91
6SL3210-1SE31-0UA0	4/91
6SL3210-1SE31-1AA0	4/91
6SL3210-1SE31-1UA0	4/91
6SL3210-1SE31-5AA0	4/91
6SL3210-1SE31-5UA0	4/91
6SL3210-1SE31-8AA0	4/91
6SL3210-1SE31-8UA0	4/91
6SL3225-0SE17-5UA1	4/28
6SL3225-0SE22-2UA1	4/28
6SL3225-0SE24-0UA1	4/28
6SL3235-0TE21-1RB0	4/43
6SL3235-0TE21-1SB0	4/43
6SL3244-0BA21-1PA0	4/76
6SL3244-0SA01-1AA1	4/28
6SL3254-0AM00-0AA0	4/44, 4/74
6SL3260-2TA00-0AA0	4/43
6SL3262-1AA00-0BA0	4/91

6SL3262-1AB00-0DA0.....	4/91	6XV1860-3PH15.....	3/122	8WD4220-5BC.....	2/129
6SL3262-1AC00-0DA0.....	4/91	6XV1860-3PH30.....	3/122	8WD4220-5BD.....	2/129
6SL3262-1AD00-0DA0.....	4/91	6XV1860-3PH50.....	3/122	8WD4220-5BE.....	2/129
6SL3262-1AF00-0DA0.....	4/91	6XV1860-3PN10.....	3/122	8WD4220-5BF.....	2/129
6SL3500-0SK01-0AA0.....	4/74	6XV1860-3PN15.....	3/122	8WD4228-0BB.....	2/129
6SL3525-0PE17-5AA0.....	4/75	6XV1860-3PN20.....	3/122	8WD4240-0FA.....	2/129
6SL3525-0PE21-5AA0.....	4/75	6XV1860-3PN25.....	3/122	8WD4240-5BB.....	2/129
6SL3525-0PE23-0AA0.....	4/75	6XV1860-3PN30.....	3/122	8WD4240-5BC.....	2/129
6SL3525-0PE24-0AA0.....	4/75	6XV1860-3PN35.....	3/122	8WD4240-5BD.....	2/129
6SL3525-0PE25-5AA0.....	4/75	6XV1860-3PN40.....	3/122	8WD4240-5BE.....	2/129
6SL3525-0PE27-5AA0.....	4/75	6XV1860-3PN45.....	3/122	8WD4240-5BF.....	2/129
6SL3544-0FA21-1FA0.....	4/70	6XV1860-3PN50.....	3/122	8WD4250-0FA.....	2/129
6SL3544-0FA21-1PA0.....	4/70	6XV1860-4PN50.....	3/122	8WD4250-5BB.....	2/129
6SL3555-0PA00-2AA0.....	4/74	6XV1860-4PT10.....	3/122	8WD4250-5BC.....	2/129
<b>6XV1</b>					
6XV1822-5BE30.....	3/165	6XV1870-2B.....	4/108	8WD4250-5BD.....	2/129
6XV1822-5BE50.....	3/165	6XV1870-2D.....	3/125, 3/136	8WD4250-5BE.....	2/129
6XV1822-5BH10.....	3/165	6XV1870-2D.....	4/108	8WD4250-5BF.....	2/129
6XV1822-5BH15.....	3/123, 3/125, 3/128, 3/137, 3/165	6XV1870-2F.....	3/125, 3/136	8WD4308-0CA.....	2/133
6XV1822-5BH20.....	3/123, 3/125, 3/129, 3/137, 3/165	6XV1870-3QE50.....	3/129, 3/137	8WD4308-0CB.....	2/133
6XV1822-5BH30.....	3/123, 3/125, 3/129, 3/137, 3/165	6XV1870-3QH10.....	3/129, 3/137	8WD4308-0DA.....	2/133
6XV1822-5BH50.....	3/123, 3/125, 3/129, 3/137, 3/165	6XV1870-3QH20.....	3/129, 3/137	8WD4308-0DB.....	2/130, 2/133
6XV1822-5BN10.....	3/123, 3/125, 3/129, 3/137, 3/165	6XV1870-3QH60.....	3/129, 3/137	8WD4308-0DC.....	2/130, 2/133
6XV1822-5BN15.....	3/123, 3/125, 3/129, 3/137	6XV1870-3QN10.....	3/129, 3/137	8WD4308-0DD.....	2/130, 2/133
6XV1830-0EH10.....	3/8, 3/14, 3/21, 3/29, 3/38, 3/46, 3/49, 3/59, 3/66, 3/72, 3/78, 3/123, 3/137, 3/181, 3/183	6XV1870-3RE50.....	3/129, 3/137	8WD4308-0DE.....	2/130, 2/133
6XV1830-0GH10.....	3/122, 3/137	6XV1870-3RH10.....	3/129, 3/137	8WD4308-0DF.....	2/133
6XV1830-0JH10.....	3/122, 3/137	6XV1870-3RH20.....	3/129, 3/137	8WD4308-0EA.....	2/130, 2/133
6XV1830-3DE30.....	3/165	6XV1870-3RH60.....	3/129, 3/137	8WD4308-0EB.....	2/130, 2/133
6XV1830-3DE50.....	3/165	6XV1870-3RN10.....	3/129, 3/137	8WD4308-0ED.....	2/130, 2/133
6XV1830-3DH10.....	3/165	6XV1870-8AE30.....	3/125, 3/136	8WD4308-0EE.....	2/130, 2/133
6XV1830-3DH15.....	3/122, 3/137, 3/165	6XV1870-8AE50.....	3/125, 3/136	8WD4328-1XX.....	2/130, 2/132
6XV1830-3DH20.....	3/122, 3/137, 3/165	6XV1870-8AH10.....	3/125, 3/136	8WD4348-1XX.....	2/130, 2/132
6XV1830-3DH30.....	3/122, 3/137, 3/165	6XV1870-8AH15.....	3/125, 3/136	8WD4358-1XX.....	2/130, 2/132
6XV1830-3DH50.....	3/122, 3/137, 3/165	6XV1870-8AH20.....	3/125, 3/136	8WD4400-1AB.....	2/131
6XV1830-3DN10.....	3/122, 3/137, 3/165	6XV1870-8AH30.....	3/125, 3/136	8WD4400-1AC.....	2/131
6XV1830-3DN15.....	3/122, 3/137, 3/165	6XV1870-8AH50.....	3/125, 3/136	8WD4400-1AD.....	2/131
6XV1830-3EH10.....	3/122, 3/137	6XV1870-8AN10.....	3/125, 3/136	8WD4400-1AE.....	2/131
6XV1830-7AN50.....	3/122	6XV1870-8AN15.....	3/125, 3/136	8WD4400-1AF.....	2/131
6XV1830-7AT10.....	3/122	6XV1873-2A.....	3/21, 3/29, 3/38, 3/49, 3/59	8WD4408-0AA.....	2/132
6XV1830-7BH15.....	3/122	6XV1875-5CH10.....	3/128	8WD4408-0AB.....	2/132
6XV1830-7BH30.....	3/122	6XV1875-5CH20.....	3/128	8WD4408-0AD.....	2/132
6XV1830-7BH50.....	3/122	6XV1875-5CH50.....	3/128	8WD4408-0AE.....	2/132
6XV1830-7BN10.....	3/122	6XV1875-5CN10.....	3/128	8WD4408-0CC.....	2/130, 2/133
6XV1830-7BN15.....	3/122	<b>8WA2</b>			
6XV1830-7BN20.....	3/122	8WA2842.....	3/118	8WD4408-0DF.....	2/130, 2/133
6XV1830-7BN25.....	3/122	8WA2868.....	3/118	8WD4408-0FA.....	2/133
6XV1830-7BN30.....	3/122	<b>8WA8</b>			
6XV1830-7BN35.....	3/122	8WA8848-2AY.....	3/118	8WD4420-0CB.....	2/131
6XV1830-7BN40.....	3/122	8WA8861-0AB.....	3/118	8WD4420-0CC.....	2/131
6XV1830-7BN45.....	3/122	8WA8861-0AC.....	3/118	8WD4420-0CD.....	2/131
6XV1830-7BN50.....	3/122	8WA8861-0DA.....	3/118	8WD4420-0CE.....	2/131
6XV1830-8AH10.....	3/122, 3/125, 3/129, 3/137, 3/165	<b>8WD4</b>			
6XV1840-2AH10.....	3/21, 3/29, 3/38, 3/49, 3/59, 3/104, 3/125, 3/136, 3/149	8WD4200-1AB.....	2/129	8WD4420-0CF.....	2/131
6XV1840-2AH10.....	4/108	8WD4200-1AC.....	2/129	8WD4420-0EA.....	2/131
6XV1840-3AH10.....	3/104, 3/125, 3/136, 3/149	8WD4200-1AD.....	2/129	8WD4420-0EA2.....	2/131
6XV1840-3AH10.....	4/108	8WD4200-1AE.....	2/129	8WD4420-0FA.....	2/131
6XV1840-4AH10.....	3/104, 3/125, 3/136, 3/149	8WD4200-1AF.....	2/129	8WD4420-1BB.....	2/131
6XV1840-4AH10.....	4/108	8WD4208-0AA.....	2/129	8WD4420-1BC.....	2/131
6XV1860-2R.....	3/123	8WD4208-0CD.....	2/130	8WD4420-1BD.....	2/131
		8WD4208-0DE.....	2/130	8WD4420-1BE.....	2/131
		8WD4208-0EF.....	2/130, 2/133	8WD4420-1BF.....	2/131
		8WD4208-0EH.....	2/130	8WD4420-5AB.....	2/132
		8WD4220-0FA.....	2/129	8WD4420-5AC.....	2/132
		8WD4220-5AB.....	2/129	8WD4420-5AD.....	2/132
		8WD4220-5AC.....	2/129	8WD4420-5AE.....	2/132
		8WD4220-5AD.....	2/129	8WD4420-5AF.....	2/132
		8WD4220-5BB.....	2/129	8WD4420-5BB.....	2/132
				8WD4420-5BC.....	2/132
				8WD4420-5BD.....	2/132
				8WD4420-5DB.....	2/132
				8WD4420-5DC.....	2/132

# Appendix

## Order number index

8WD4420-5DD .....	2/132	8WD5320-5BC .....	2/134
8WD4428-0BD .....	2/132	8WD5320-5BD .....	2/134
8WD4428-0BE .....	2/132	8WD5320-5DB .....	2/134
8WD4428-6XB .....	2/130, 2/132	8WD5320-5DC .....	2/134
8WD4428-6XC .....	2/130, 2/132	8WD5320-5DD .....	2/134
8WD4428-6XD .....	2/130, 2/132	8WD5340-0CB .....	2/134
8WD4428-6XE .....	2/130, 2/132	8WD5340-0CC .....	2/134
8WD4428-6XF .....	2/130, 2/132	8WD5340-0CD .....	2/134
8WD4440-0CB .....	2/131	8WD5340-0CE .....	2/134
8WD4440-0CC .....	2/131	8WD5340-0CF .....	2/134
8WD4440-0CD .....	2/131	8WD5350-0CB .....	2/134
8WD4440-0CE .....	2/131	8WD5350-0CC .....	2/134
8WD4440-0CF .....	2/131	8WD5350-0CD .....	2/134
8WD4440-0EA2 .....	2/131	8WD5350-0CE .....	2/134
8WD4440-0FA .....	2/131	8WD5350-0CF .....	2/134
8WD4440-1BB .....	2/131		
8WD4440-1BC .....	2/131	<b>9AL3</b>	
8WD4440-1BD .....	2/131	9AL3100-1AD54 .....	3/83
8WD4440-1BE .....	2/131		
8WD4440-1BF .....	2/131		
8WD4440-5AB .....	2/132		
8WD4440-5AC .....	2/132		
8WD4440-5AD .....	2/132		
8WD4440-5AE .....	2/132		
8WD4440-5AF .....	2/132		
8WD4448-6XB .....	2/130, 2/132		
8WD4448-6XC .....	2/130, 2/132		
8WD4448-6XD .....	2/130, 2/132		
8WD4448-6XE .....	2/130, 2/132		
8WD4448-6XF .....	2/130, 2/132		
8WD4450-0CB .....	2/131		
8WD4450-0CC .....	2/131		
8WD4450-0CD .....	2/131		
8WD4450-0CE .....	2/131		
8WD4450-0CF .....	2/131		
8WD4450-0EA2 .....	2/131		
8WD4450-0FA .....	2/131		
8WD4450-1BB .....	2/131		
8WD4450-1BC .....	2/131		
8WD4450-1BD .....	2/131		
8WD4450-1BE .....	2/131		
8WD4450-1BF .....	2/131		
8WD4450-5AB .....	2/132		
8WD4450-5AC .....	2/132		
8WD4450-5AD .....	2/132		
8WD4450-5AE .....	2/132		
8WD4450-5AF .....	2/132		
8WD4458-6XB .....	2/130, 2/132		
8WD4458-6XC .....	2/130, 2/132		
8WD4458-6XD .....	2/130, 2/132		
8WD4458-6XE .....	2/130, 2/132		
8WD4458-6XF .....	2/130, 2/132		
<b>8WD5</b>			
8WD5300-1AB .....	2/134		
8WD5300-1AC .....	2/134		
8WD5300-1AD .....	2/134		
8WD5300-1AE .....	2/134		
8WD5300-1AF .....	2/134		
8WD5320-0CB .....	2/134		
8WD5320-0CC .....	2/134		
8WD5320-0CD .....	2/134		
8WD5320-0CE .....	2/134		
8WD5320-0CF .....	2/134		
8WD5320-5AB .....	2/134		
8WD5320-5AC .....	2/134		
8WD5320-5AD .....	2/134		
8WD5320-5BB .....	2/134		



## Overview

### Software types

Software requiring a license is categorized into types. The following software types have been defined:

- Engineering software
- Runtime software

### Engineering software

This includes all software products for creating (engineering) user software, e.g. for configuring, programming, parameterizing, testing, commissioning or servicing.

Data generated with engineering software and executable programs can be duplicated for your own use or for use by third-parties free-of-charge.

### Runtime software

This includes all software products required for plant/machine operation, e.g. operating system, basic system, system expansions, drivers, etc.

The duplication of the runtime software and executable programs created with the runtime software for your own use or for use by third-parties is subject to a charge.

You can find information about license fees according to use in the ordering data (e.g. in the catalog). Examples of categories of use include per CPU, per installation, per channel, per instance, per axis, per control loop, per variable, etc.

Information about extended rights of use for parameterization/configuration tools supplied as integral components of the scope of delivery can be found in the readme file supplied with the relevant product(s).

### License types

Siemens Industry Automation & Drive Technologies offers various types of software license:

- Floating license
- Single license
- Rental license
- Trial license

### Floating license

The software may be installed for internal use on any number of devices by the licensee. Only the concurrent user is licensed. The concurrent user is the person using the program. Use begins when the software is started.

A license is required for each concurrent user.

### Single license

Unlike the floating license, a single license permits only one installation of the software.

The type of use licensed is specified in the ordering data and in the Certificate of License (CoL). Types of use include for example per device, per axis, per channel, etc.

One single license is required for each type of use defined.

### Rental license

A rental license supports the "sporadic use" of engineering software. Once the license key has been installed, the software can be used for a specific number of hours (the operating hours do not have to be consecutive).

One license is required for each installation of the software.

### Trial license

A trial license supports "short-term use" of the software in a non-productive context, e.g. for testing and evaluation purposes. It can be transferred to another license.

### Factory license

With the Factory License the user has the right to install and use the software at one permanent establishment only. The permanent establishment is defined by one address only. The number of hardware devices on which the software may be installed results from the order data or the Certificate of License (CoL).

### Certificate of license

The Certificate of License (CoL) is the licensee's proof that the use of the software has been licensed by Siemens. A CoL is required for every type of use and must be kept in a safe place.

### Downgrading

The licensee is permitted to use the software or an earlier version/release of the software, provided that the licensee owns such a version/release and its use is technically feasible.

### Delivery versions

Software is constantly being updated. The following delivery versions

- PowerPack
- Upgrade

can be used to access updates.

Existing bug fixes are supplied with the ServicePack version.

### PowerPack

PowerPacks can be used to upgrade to more powerful software. The licensee receives a new license agreement and CoL (Certificate of License) with the PowerPack. This CoL, together with the CoL for the original product, proves that the new software is licensed.

A separate PowerPack must be purchased for each original license of the software to be replaced.

### Upgrade

An upgrade permits the use of a new version of the software on the condition that a license for a previous version of the product is already held.

The licensee receives a new license agreement and CoL with the upgrade. This CoL, together with the CoL for the previous product, proves that the new version is licensed.

A separate upgrade must be purchased for each original license of the software to be upgraded.

### ServicePack

ServicePacks are used to debug existing products.

ServicePacks may be duplicated for use as prescribed according to the number of existing original licenses.

### License key

Siemens Industry Automation & Drive Technologies supplies software products with and without license keys.

The license key serves as an electronic license stamp and is also the "switch" for activating the software (floating license, rental license, etc.).

The complete installation of software products requiring license keys includes the program to be licensed (the software) and the license key (which represents the license).

Detailed explanations concerning license conditions can be found in the "Terms and Conditions of Siemens AG" or under

<http://www.siemens.com/industrymall>  
(Industry Mall Online-Help System)

## Conditions of sale and delivery Export regulations

### Terms and Conditions of Sale and Delivery

By using this catalog you can acquire hardware and software products described therein from Siemens AG subject to the following terms. Please note! The scope, the quality and the conditions for supplies and services, including software products, by any Siemens entity having a registered office outside of Germany, shall be subject exclusively to the General Terms and Conditions of the respective Siemens entity. The following terms apply exclusively for orders placed with Siemens AG.

#### For customers with a seat or registered office in Germany

The "General Terms of Payment" as well as the "General Conditions for the Supply of Products and Services of the Electrical and Electronics Industry" shall apply.

For software products, the "General License Conditions for Software Products for Automation and Drives for Customers with a Seat or registered Office in Germany" shall apply.

#### For customers with a seat or registered office outside of Germany

The "General Terms of Payment" as well as the "General Conditions for Supplies of Siemens. Automation and Drives for Customers with a Seat or registered Office outside of Germany" shall apply.

For software products, the "General License Conditions for Software Products for Automation and Drives for Customers with a Seat or registered Office outside of Germany" shall apply.

#### General

The dimensions are in mm. In Germany, according to the German law on units in measuring technology, data in inches only apply to devices for export.

Illustrations are not binding.

Insofar as there are no remarks on the corresponding pages, - especially with regard to data, dimensions and weights given - these are subject to change without prior notice.

The prices are in € (Euro) ex works, exclusive packaging.

The sales tax (value added tax) is not included in the prices. It shall be debited separately at the respective rate according to the applicable legal regulations.

Prices are subject to change without prior notice. We will debit the prices valid at the time of delivery.

Surcharges will be added to the prices of products that contain silver, copper, aluminum, lead and/or gold if the respective basic official prices for these metals are exceeded. These surcharges will be determined based on the official price and the metal factor of the respective product.

The surcharge will be calculated on the basis of the official price on the day prior to receipt of the order or prior to the release order.

The metal factor determines the official price as of which the metal surcharges are charged and the calculation method used. The metal factor, provided it is relevant, is included with the price information of the respective products.

An exact explanation of the metal factor and the text of the Comprehensive Terms and Conditions of Sale and Delivery are available free of charge from your local Siemens business office under the following Order Nos.:

- 6ZB5310-0KR30-0BA1  
(for customers based in Germany)
- 6ZB5310-0KS53-0BA1  
(for customers based outside Germany)

or download them from the Internet  
[www.siemens.com/industrymall](http://www.siemens.com/industrymall)  
(Germany: Industry Mall Online-Help System)

### Export regulations

Our obligation to fulfill this agreement is subject to the proviso that the fulfillment is not prevented by any impediments arising out of national and international foreign trade and customs requirements or any embargos and/or other sanctions.

If you transfer goods (hardware and/ or software and/ or technology as well as corresponding documentation, regardless of the mode of provision) delivered by us or works and services (including all kinds of technical support) performed by us to a third party worldwide, you shall comply with all applicable national and international (re-) export control regulations.

If required to conduct export control checks, you, upon request by us, shall promptly provide us with all information pertaining to particular end customer, destination and intended use of goods, works and services provided by us, as well as any export control restrictions existing.

The products listed in this catalog / price list may be subject to European / German and/or US export regulations.

Therefore, any export requiring a license is subject to approval by the competent authorities.

According to current provisions, the following export regulations must be observed with respect to the products featured in this catalog / price list:

AL	<p>Number of the <u>German Export List</u></p> <p>Products marked other than "N" require an export license.</p> <p>In the case of software products, the export designations of the relevant data medium must also be generally adhered to.</p> <p>Goods labeled with an "<u>AL" not equal to "N"</u> are subject to a European or German export authorization when being exported out of the EU.</p>
ECCN	<p><u>Export Control Classification Number</u></p> <p>Products marked other than "N" are subject to a reexport license to specific countries.</p> <p>In the case of software products, the export designations of the relevant data medium must also be generally adhered to.</p> <p>Goods labeled with an "<u>ECCN" not equal to "N"</u> are subject to a US re-export authorization.</p>

Even without a label or with an "AL: N" or "ECCN: N", authorization may be required due to the final destination and purpose for which the goods are to be used.

The deciding factors are the AL or ECCN export authorization indicated on order confirmations, delivery notes and invoices.

Errors excepted and subject to change without prior notice.

## Industry Automation, Drive Technologies and Low Voltage Distribution

Further information can be obtained from our branch offices listed in the appendix or at [www.siemens.com/automation/partner](http://www.siemens.com/automation/partner)

<b>Interactive Catalog on DVD</b>	<i>Catalog</i>	<b>Motion Control</b>	<i>Catalog</i>
for Industry Automation, Drive Technologies and Low Voltage Distribution	<b>CA 01</b>	SINUMERIK & SIMODRIVE Automation Systems for Machine Tools	NC 60
<b>Drive Systems</b>		SINUMERIK & SINAMICS Equipment for Machine Tools	NC 61
<u>Variable-Speed Drives</u>		SINUMERIK 828D BASIC T/BASIC M, SINAMICS S120 Combi and 1FK7/1PH8 motors	NC 82
SINAMICS G110, SINAMICS G120 Standard Inverters	D 11.1	SIMOTION, SINAMICS S120 and Motors for Production Machines	PM 21
SINAMICS G110D, SINAMICS G120D Distributed Inverters		SINAMICS S110 The Basic Positioning Drive	PM 22
SINAMICS G130 Drive Converter Chassis Units	D 11		
SINAMICS G150 Drive Converter Cabinet Units		<b>Power Supply and System Cabling</b>	
SINAMICS GM150, SINAMICS SM150 Medium-Voltage Converters	D 12	Power supply SITOP	KT 10.1
SINAMICS S120 Chassis Format Units and Cabinet Modules	D 21.3	System cabling SIMATIC TOP connect	KT 10.2
SINAMICS S150 Converter Cabinet Units		<b>Process Instrumentation and Analytics</b>	
SINAMICS DCM Converter Units	D 23.1	Field Instruments for Process Automation	FI 01
<u>Three-phase Induction Motors</u>	D 84.1	SIREC Recorders and Accessories	MP 20
• H-compact		SIPART, Controllers and Software	MP 31
• H-compact PLUS		Products for Weighing Technology	WT 10
Asynchronous Motors Standardline	D 86.1	Process Analytical Instruments	PA 01
Synchronous Motors with Permanent-Magnet Technology, HT-direct	D 86.2	<i>PDF: Process Analytics, Components for the System Integration</i>	PA 11
DC Motors	DA 12		
SIMOREG DC MASTER 6RA70 Digital Chassis Converters	DA 21.1	<b>Safety Integrated</b>	
SIMOREG K 6RA22 Analog Chassis Converters	DA 21.2	Safety Technology for Factory Automation	SI 10
<i>PDF: SIMOREG DC MASTER 6RM70 Digital Converter Cabinet Units</i>	DA 22		
SIMOVERT PM Modular Converter Systems	DA 45	<b>SIMATIC HMI/PC-based Automation</b>	
SIEMOSYN Motors	DA 48	Human Machine Interface Systems/ PC-based Automation	ST 80/ ST PC
MICROMASTER 420/430/440 Inverters	DA 51.2		
MICROMASTER 411/COMBIMASTER 411	DA 51.3	<b>SIMATIC Industrial Automation Systems</b>	
SIMOVERT MASTERDRIVES Vector Control	DA 65.10	Products for Totally Integrated Automation and Micro Automation	ST 70
SIMOVERT MASTERDRIVES Motion Control	DA 65.11	SIMATIC PCS 7 Process Control System	ST PCS 7
Synchronous and asynchronous servomotors for SIMOVERT MASTERDRIVES	DA 65.3	Add-ons for the SIMATIC PCS 7 Process Control System	ST PCS 7.1
SIMODRIVE 611 universal and POSMO	DA 65.4	<i>PDF: Migration solutions with the SIMATIC PCS 7 Process Control System</i>	ST PCS 7.2
SIMOTION, SINAMICS S120 and Motors for Production Machines	PM 21		
SINAMICS S110	PM 22	<b>SIMATIC NET</b>	
The Basic Positioning Drive		Industrial Communication	IK PI
<u>Low-Voltage Three-Phase-Motors</u>			
IEC Squirrel-Cage Motors	D 81.1	<b>SIMATIC Sensors</b>	
MOTOX Geared Motors	D 87.1	Sensor Technology for Factory Automation	FS 10
<u>Automation Systems for Machine Tools SIMODRIVE</u>	NC 60	Industrial Identification Systems	ID 10
• Motors			
• Converter Systems SIMODRIVE 611/POSMO		<b>SINVERT Photovoltaics</b>	
<u>Automation Systems for Machine Tools SINAMICS</u>	NC 61	Inverters and Components for Photovoltaic Installations	RE 10
• Motors			
• Drive System SINAMICS S120		<b>SIRIUS Industrial Controls</b>	
<u>Drive and Control Components for Hoisting Equipment</u>	HE 1	SIRIUS Industrial Controls	IC 10
<u>Mechanical Driving Machines</u>		SIRIUS Industrial Controls (selected content from catalog IC 10)	IC 90
FLENDER Standard Couplings	MD 10.1		
		<b>System Solutions</b>	
<b>Low-Voltage Power Distribution and Electrical Installation Technology</b>		Applications and Products for Industry are part of the interactive catalog CA 01	
Protection, Switching, Measuring & Monitoring Devices	LV 10.1		
Switchboards and Distribution Systems	LV 10.2		
GAMMA Building Management Systems	ET G1		
<i>PDF: DELTA Switches and Socket Outlets</i>	ET D1		
SICUBE System Cubicles and Cubicle Air-Conditioning	LV 50		
SIVACON 8PS Busbar Trunking Systems	LV 70		

*PDF: These catalogs are only available as pdf files.*

#### Download-Center

PDF versions of the catalogs are available on the Internet at:  
[www.siemens.com/automation/infocenter](http://www.siemens.com/automation/infocenter)

Siemens AG  
Industry Sector  
Industry Automation  
and Drive Technologies  
Postfach 48 48  
90026 NÜRNBERG  
GERMANY

Subject to change without prior notice  
Order No. E86060-K7010-A101-A2-7600  
3P.8301.01.02 / Dispo 27610  
KG 0511 5. S 544 En  
Printed in Germany  
© Siemens AG 2011

[www.siemens.com/safety-integrated](http://www.siemens.com/safety-integrated)

The information provided in this catalog contains descriptions or characteristics of performance which in case of actual use do not always apply as described or which may change as a result of further development of the products. An obligation to provide the respective characteristics shall only exist if expressly agreed in the terms of contract. Availability and technical specifications are subject to change without notice.  
All product designations may be trademarks or product names of Siemens AG or supplier companies whose use by third parties for their own purposes could violate the rights of the owners.