

Current Protective Devices

Configuration Manual · 10/2010



SENTRON

Answers for infrastructure.

SIEMENS

Current Protective Devices











4	Introduction
5	5SM3 RCCBs, type A
7	SEQUENCE 5SM3 and 5SU1 universal current-sensitive RCCBs, type B and type B+
12	Additional components
14	5SM2 RC units, type A
16	5SU1 RCBOs, type A
23	Busbars
25	5SM1 and 5SZ9 RCCB socket outlets
26	Residual-current operated circuit breakers

Current protective devices

Introduction

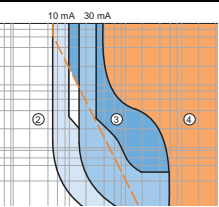
Overview

Devices	Page	Application	Standards	Used in		
				Non-residential buildings	Residential buildings	Industry
	5	Personnel, material and fire protection, as well as protection against direct contact. SIGRES with active condensation protection for use in harsh environments. Super resistant and selective versions	IEC/EN 61008	✓	✓	✓
	7	SIQUENCE, the technology of universal current-sensitive residual current protective devices	VDE 0664-100 VDE 0664-200 VDE V 0664-110	✓	--	✓
	12	Remote controlled mechanisms, auxiliary switches for all residual current operated circuit breakers. Leakage current measurement device for fault locating and the optimum selection of RCCBs	IEC/EN 62019	✓	--	✓
	14	The freely selectable combination of RC units with miniature circuit breakers permits the flexible configuration of RCBO combinations	IEC/EN 61009	✓	--	✓
	16	The ideal protection combination for all electrical circuits due to the compact device versions of RCCBs and miniature circuit breakers in a single device	IEC/EN 61009	✓	✓	✓
	23	Busbars in 10 mm ² and 16 mm ² save space in the distribution board and time during mounting.	--	✓	✓	✓
	25	For retrofitting in existing installations	VDE 0664	✓	✓	✓
	26	This section tells you all you need to know about RCCBs in combination with miniature circuit breakers, such as tripping characteristics, selectivity and breaking capacity	--	✓	✓	✓
		Monitoring of residual currents in electrical plants with signaling if a specified limit value is exceeded. see chapter: "Monitoring Devices —> Monitoring devices for electrical values —> Residual current monitors"	IEC 62020 EN 62020	✓	--	✓

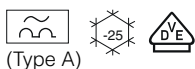

5SM3 RCCBs, type A

Overview

RCCBs of type A are used in all systems up to 240/415 V AC. They trip in the event of both sinusoidal AC residual currents and pulsating DC residual currents.

RCCBs with a rated residual current of maximum 30 mA are used for personnel, material and fire protection, as well as for protection against direct contact. RCCBs with a rated residual current of 10 mA are primarily used in areas that represent an increased risk for personnel.

Since DIN VDE 0100-410 came into effect in June 2007, all socket outlet current circuits up to 20 A must now also be fitted with residual current protective devices with a rated residual current of max. 30 mA. This also applies to outdoor electrical circuits up to 32 A for the connection of portable equipment.

Devices with a rated residual current of maximum 300 mA are used as preventative fire protection in case of insulation faults. RCCBs with a rated residual current of 100 mA are primarily used outside Europe.

Technical specifications

			Instantaneous	SIGRES	Super resistant	Selective
Standards			IEC/EN 61008-1 (VDE 0664-10), IEC/EN 61008-2-1 (VDE 0664-11); IEC/EN 61543 (VDE 0664-30)			
Approvals			IEC 61008-1, IEC 61008-2-1; EN 61008-1, EN 61008-2-1			
Surge current withstand capability						
With current waveform 8/20 μ s	Acc. to DIN VDE 0432-2	kA	> 1		> 3	> 5
Minimum operational voltage for test function operation		V AC	100			
Insulation coordination						
• Overvoltage category			III			
Terminal conductor cross-sections						
• For 2 MW	At $I_n = 16$ A, 25 A, 40 A	mm ²	1.0 ... 16			
	At $I_n = 100$ A, 125 A	mm ²	1.5 ... 50	--	--	--
• For 2.5 MW	At $I_n = 63$ A, 80 A	mm ²	1.5 ... 25			
• For 4 MW	At $I_n = 25$ A, 40 A, 63 A, 80 A	mm ²	1.5 ... 25			
	At $I_n = 125$ A	mm ²	2.5 ... 50	--	--	2.5 ... 50
Terminal tightening torque						
• Up to $I_n = 80$ A		Nm	2.5 ... 3.0			
	• At $I_n = 100$ A, 125 A	Nm	3.0 ... 3.5	--	--	3.0 ... 3.5
Mains connection			Top or bottom	Bottom	Top or bottom	
Mounting position			any			
Degree of protection	Acc. to EN 60529 (VDE 0470-1)		IP20, if the distribution board is installed, with connected conductors			
Touch protection	Acc. to EN 50274 (VDE 0660-514)		Finger and back-of-hand safe			
Service life	Test cycle acc. to IEC/EN 61008	Switching cycles	> 10000			
Storage temperature		°C	-40 ... +75			
Ambient temperature		°C	-25 ... +45, marked with 			
Resistance to climate	Acc. to IEC 60068-2-30		28 cycles (55 °C; 95 % rel. air humidity)			
CFC and silicone-free			Yes			

5SM3 RCCBs, type A

Dimensional drawings

RCCBs up to 80 A

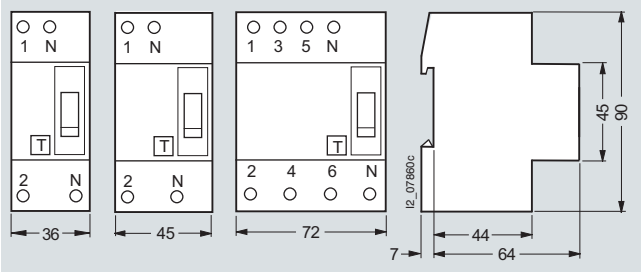

1P+N 2 MW 1P+N 2.5 MW 3P+N 4 MW

RCCBs 100 and 125 A

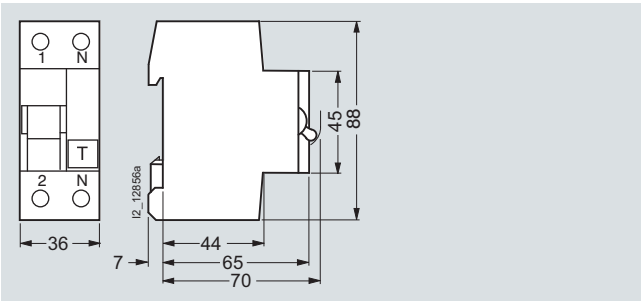

1P+N, 2 MW

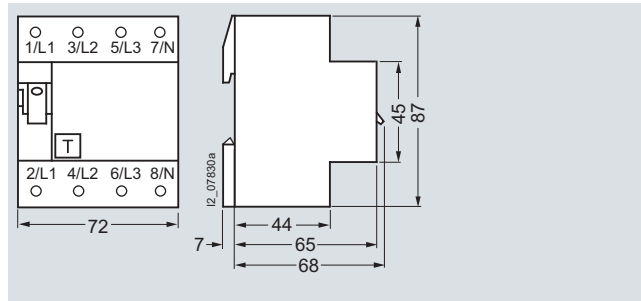

3P+N, 4 MW

Schematics

Diagrams

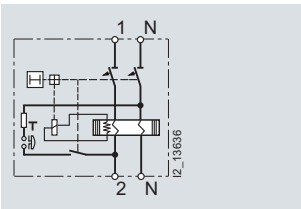

1P+N

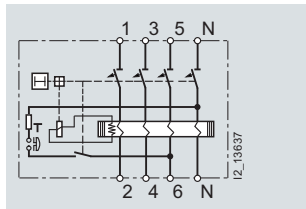

3P+N up to 80 A
N-connection, right

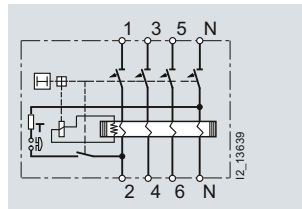

3P+N
100 A, 125 A

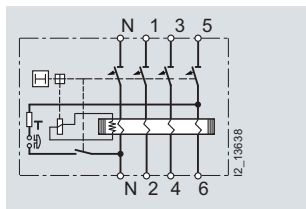

N connection, left

Note:
The infeed for SIGRES devices must be from below at terminals 2, 4, 6 and N.

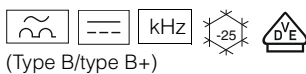

(Type B/type B+)

Current protective devices

SIQUENCE 5SM3 and 5SU1 universal current-sensitive RCCBs, type B and type B+

Overview

Frequency converters, medical devices and UPS systems are seeing increasing use in industry. Smooth DC residual currents or currents with low residual ripple may occur in the event of faults on these devices.

Type A residual current protective devices are unable to detect these smooth DC residual currents. Furthermore, such smooth DC residual currents make Type A devices increasingly insensitive to AC residual currents and pulsating DC residual currents. If a fault occurs, there is therefore no tripping and the desired protective function is no longer assured.

UC-sensitive residual current protective devices of Types B and B+ have an additional transformer which is supplied with a control signal. This enables an evaluation of the change of the trans-

former's operating range caused by smooth DC residual currents, thus ensuring the desired protective function.

The residual current protective devices of type B are suitable for use in three-phase current systems before input circuits with rectifiers. They are not intended for use in DC systems and in networks with operating frequencies other than 50 Hz or 60 Hz.

The devices in this series are designed as residual current operated circuit breakers (RCCBs) up to 80 A and as residual current circuit breakers with integral overcurrent protection (RCBOs) for 100 A or 125 A in Characteristics C or D.

Type B+ residual current protective devices also offer enhanced, preventative fire protection. In these versions, the tripping value is limited to a maximum of 420 mA up to 20 kHz.

Technical specifications

	SIQUENCE, RCCBs Type B and type B+ 5SM3		SIQUENCE RCBOs Type B and type B+ 5SU1
Standards	IEC/EN 61008-1 (VDE 0664-10); VDE 0664-100; IEC/EN 61543 (VDE 0664-30); IEC 62423 And in addition for type B+: DIN V VDE V 0664-110		IEC/EN 61009-1 (VDE 0664-20); VDE 0664-200; IEC/EN 61543 (VDE 0664-30); IEC 62423
Versions	1P+N	3P+N	4P
Tripping characteristic	--	--	C, D
Surge current withstand capability with current waveform 8/20 μs acc. to DIN VDE 0432-2			
• Super resistant	kA	> 3	> 3
• Selective	kA	--	> 5
Minimum operational voltage for test function operation	V AC	150	150
Rated voltages U_n	V AC	230	400, 480
Rated frequency f_n	Hz	50 ... 60	
Rated currents I_n	A	16, 25, 40, 63	25, 40, 63, 80
Rated residual currents $I_{\Delta n}$	mA	30, 300	30, 300, 500
Rated switching capacity			
• I_m	A	800	--
• I_{cn}	kA	--	10
Insulation coordination			
• Overvoltage category		III	
Conductor cross-sections			
• Solid and stranded	mm ²	1.5 ... 25	6 ... 50
• Finely stranded, with end sleeve	mm ²	1.5 ... 16	6 ... 35
Terminal tightening torques for all devices	Nm	2.5 ... 3.0	3.0 ... 3.5
Mains connection		Either top or bottom	
Mounting position		any	
Degree of protection acc. to EN 60529 (VDE 0470-1)		IP20, if the distribution board is installed, with connected conductors	
Touch protection according to EN 50274 (VDE 0660-514)		Finger and back-of-hand safe	
Service life, electrical and mechanical; (test cycle acc. to regulations)		> 10 000 switching cycles	
Storage temperature	°C	-40 ... +75	
Ambient temperature	°C	-25 ... +45, marked with	
Resistance to climate acc. to IEC 60068-2-30		28 cycles (55 °C; 95 % rel. air humidity)	
CFC and silicone-free		Yes	

SIQUENCE 5SM3 and 5SU1 universal current-sensitive RCCBs, type B and type B+

Characteristic curves

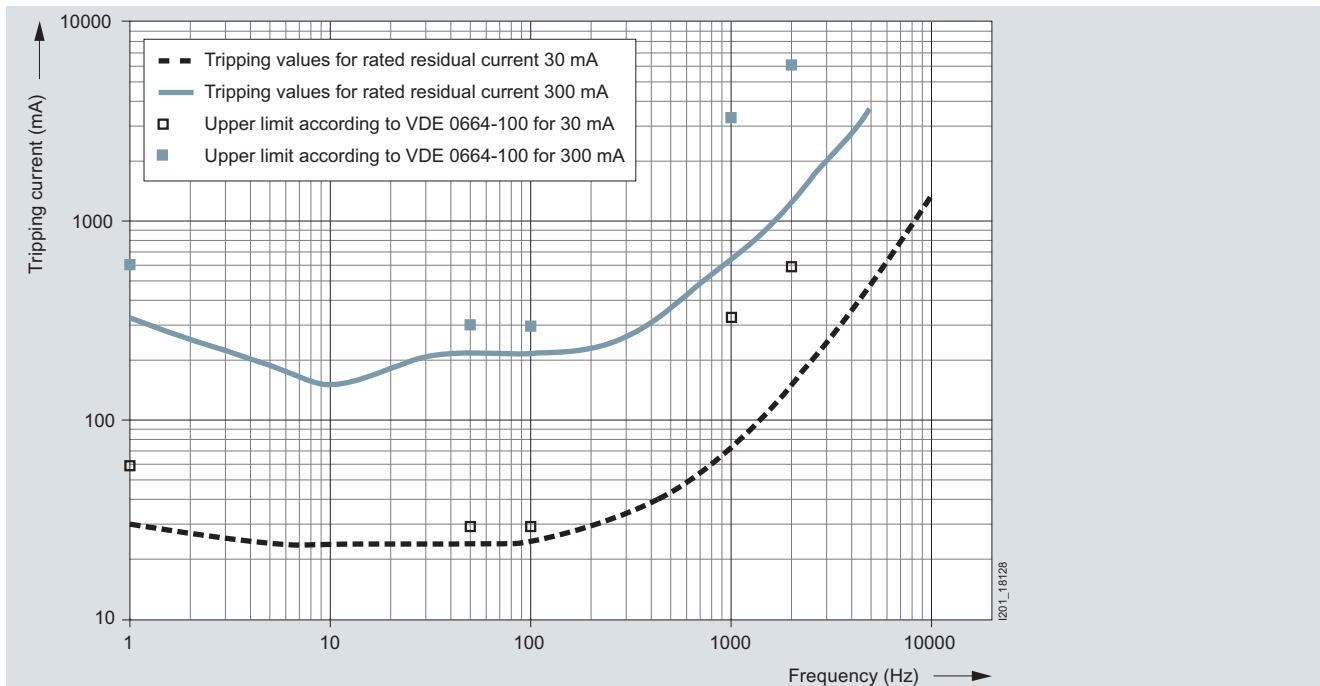

Tripping current as a function of frequency for type B

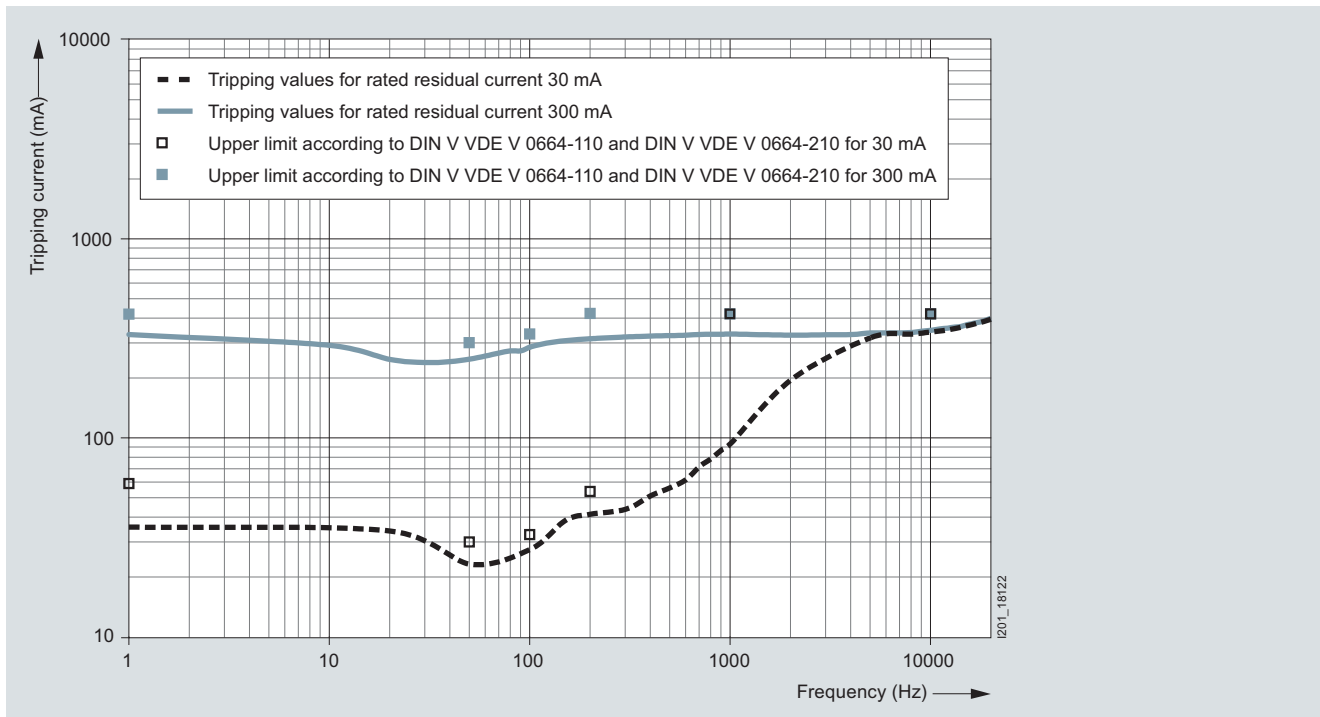

Tripping current as a function of frequency for type B+

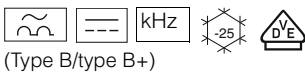

Current protective devices

SIQUENCE 5SM3 and 5SU1 universal current-sensitive RCCBs, type B and type B+

Dimensional drawings

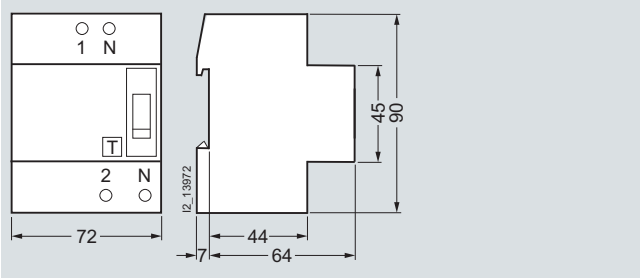

SIQUENCE RCCBs, type B and type B+
1P+N, 4 MW

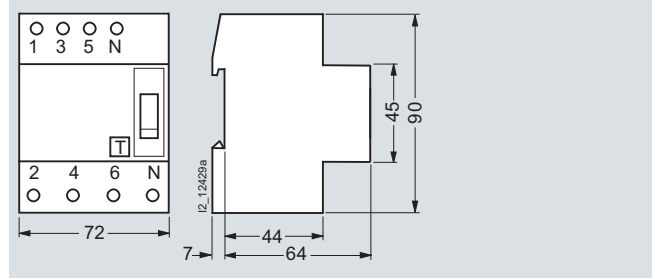

SIQUENCE RCCBs, type B and type B+
3P+N, 4 MW

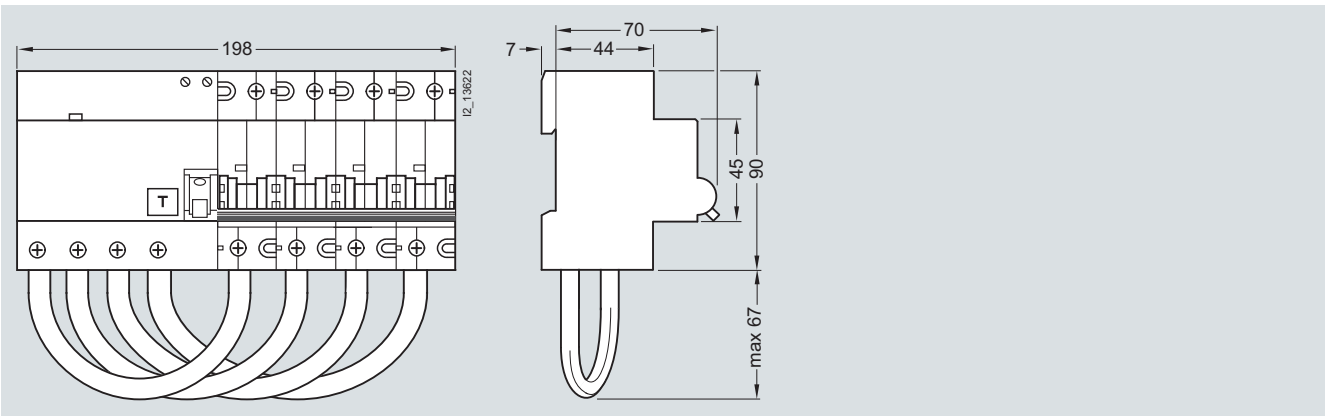

SIQUENCE RCBOs, type B and type B+
4P, 11 MW

Schematics

Diagrams

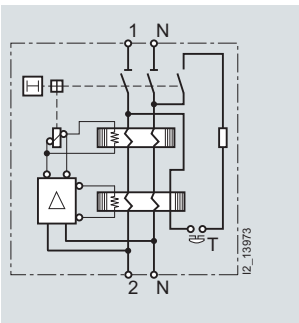

SIQUENCE RCCBs,
type B and type B+
1P+N, 4 MW

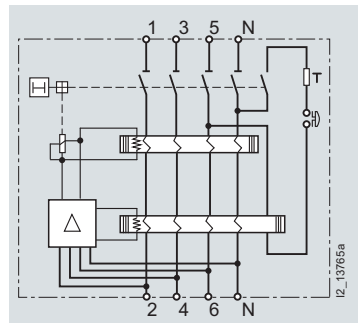

SIQUENCE RCCBs,
type B and type B+
3P+N, 4 MW

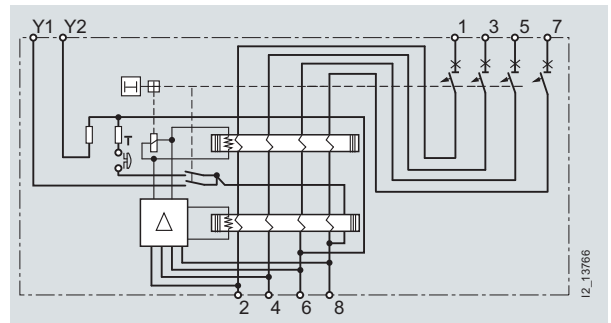

SIQUENCE RCBOs,
type B and type B+
4P, 11 MW

SIQUENCE 5SM3 and 5SU1 universal current-sensitive RCCBs, type B and type B+

More information

Device setup

Universal current-sensitive protective devices are based on a pulse-current-sensitive circuit-protection device with tripping independent of line voltage, supplemented with an auxiliary unit for the detection of smooth DC residual currents. The following design diagrams show the basic design.

The summation current transformer W1 monitors the electrical system for AC and pulse current-type residual currents. The summation current transformer W2 detects the smooth DC residual currents and, in the event of a fault, relays the tripping command through electronic unit E to release A, which uses the mechanics to disconnect the circuit.

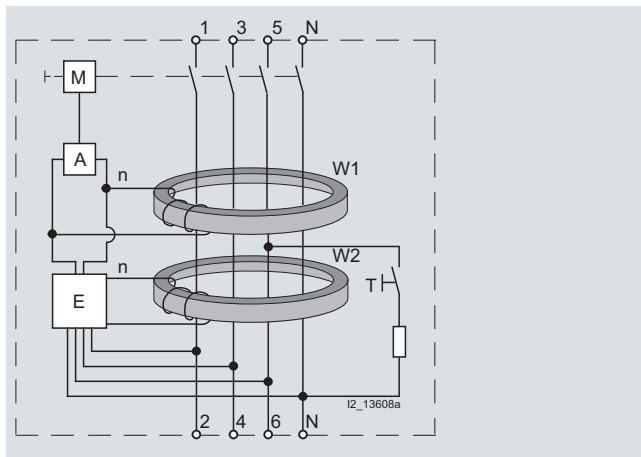

Design of RCCBs type B and type B+

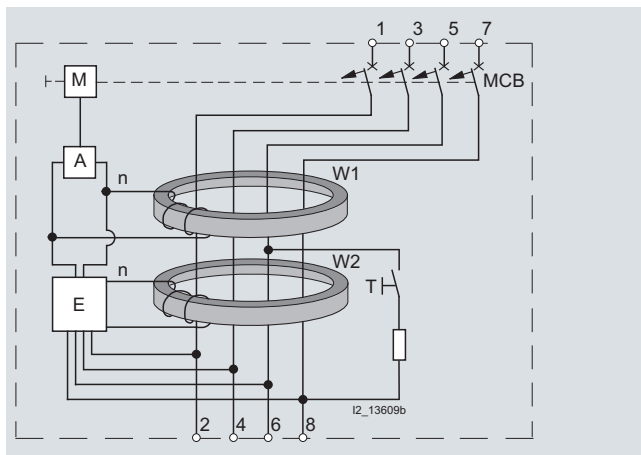

Design of RCBOs type B and type B+

M	Mechanics of the RCCB
MCB	Miniature circuit breaker component
A	Releases
E	Electronics for tripping in the event of smooth DC residual currents
n	Secondary winding
W1	Summation current transformer for detection of sinusoidal residual currents
W2	Summation current transformer for detection of smooth DC residual currents
T	Test button

Method of operation

The universal current-sensitive residual current protective devices work independent of the supply voltage compliant with requirements in Germany for Type A according to DIN VDE 0664-100.

A voltage supply is required solely for the detection of smooth DC residual currents by a second transformer. This is done from all system cables and is dimensioned so that the electronics still reliably trip even with a voltage reduction to 50 V.

This ensures tripping for smooth DC residual currents, as long as such residual current waveforms can occur, even in the event of faults in the electrical power supply, e.g. an N-conductor break. This means that the pulse-current-sensitive switch part, which trips regardless of line voltage, will still reliably trigger the tripping operation - even in the highly unlikely event that two outer conductors and the neutral conductor fail - if the remaining intact outer conductor presents a fire hazard due to a ground fault.

The residual current protective devices of type B are suitable for use in three-phase current systems before input circuits with rectifiers. They are not intended for use in DC systems and in networks with operating frequencies other than 50 Hz or 60 Hz.

RCBOs are a combination of an RCCB and a miniature circuit breaker for up to 125 A in a single compact device.

This means they provide not only personnel, property and fire protection, but also overload and short-circuit protection for cables. The mechanics of the residual current protective device act on the tripping unit of the miniature circuit breaker, which disconnects the circuit.

Protective effect at high frequencies

In addition to the described residual current waveforms (AC residual currents, pulsating and smooth DC residual currents),

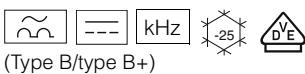

(Type B/type B+)

Current protective devices

SIQUENCE 5SM3 and 5SU1 universal current-sensitive RCCBs, type B and type B+

AC residual currents with a wide range of frequencies may also occur on electronic equipment such as rectifiers in frequency converters or computer tomographs as well as at the outgoing terminal of a frequency converter.

Requirements for frequencies up to 2 kHz are defined in the device regulations VDE 0664 -100.

To date, only limited statements can be made with regard to the risk of ventricular fibrillations (up to 1 kHz) for frequencies higher than 100 Hz. No reliable statements can be made on any further effects of thermal or electrolytic influence on the human organism.

For this reason, protection against direct contact is only possible for frequencies up to 100 Hz.

For higher frequencies, protection against indirect contact must be implemented under consideration of the frequency response of the residual current protective device, the maximum permissible touch voltages up to 50 V and permissible grounding resistance derived from this information.

Rated residual current For touch voltage	Max. permissible grounding resistance	
	50 V	25 V
30 mA	120 Ω	60 Ω
300 mA	16 Ω	8 Ω
500 mA	10 Ω	5 Ω

Max. permissible grounding resistance for SIQUENCE universal current-sensitive residual current protective devices type B

Rated residual current For touch voltage	Max. permissible grounding resistance	
	50 V	25 V
30 mA, 300 mA	120 Ω	60 Ω

Max. permissible grounding resistance for SIQUENCE universal current-sensitive residual current protective devices type B+

Versions

Super resistant **K**
Short-time delayed tripping in the case of transient leakage currents. High surge current withstand capability: > 3 kA.

Selective **S**:
Can be used as upstream group switch for selective tripping contrary to a downstream, instantaneous or super resistant RCCB.

Configuration

DIN VDE 0100-530 "Selection of protective devices" also describes the configuration of systems with residual current protective devices.

EN 50178 (DIN VDE 0160) "Equipping power installations with electronic equipment" describes, among other things, how to select the type of residual current protective device suitable.

When configuring and installing electrical installations, electrical loads that can generate smooth DC residual currents in the event of a fault must be assigned a separate electrical circuit with a universal current-sensitive residual current protective device (type B) (see configuration example).

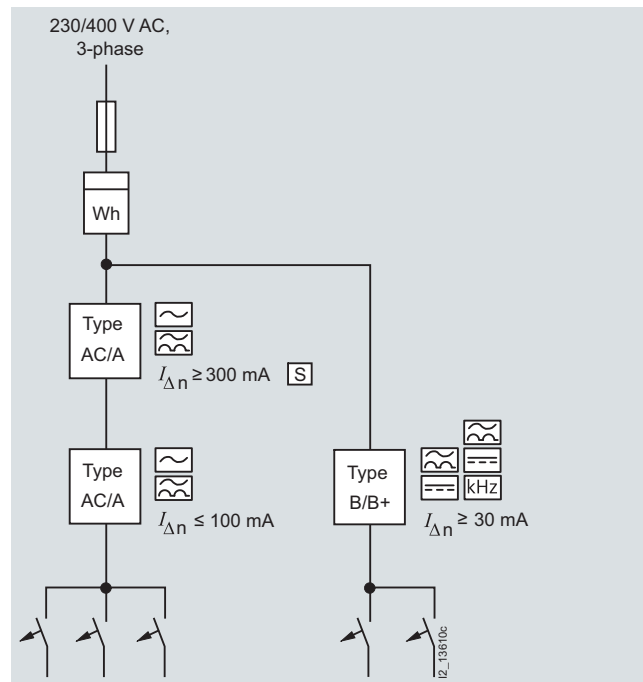

It is not permitted to branch electrical circuits with these types of electrical loads after pulse-current-sensitive residual current protective devices (type A):

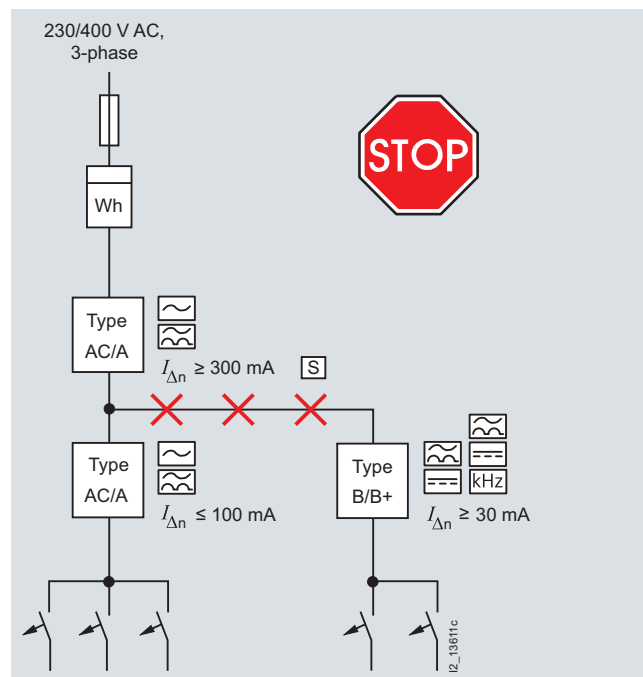

Current protective devices

Additional components

Overview

Auxiliary switches (AS) signal the contact position of the RCCB.

Remote controlled mechanisms are used for the remote ON/OFF switching of RCCBs. They also enable local manual switching. A blocking function permits maintenance work. A tripped RCCB must be acknowledged prior to switching back on.

The leakage current measurement device detects the leakage currents – like the circuit breaker – thus providing a direct statement as to the current loading of the RCCB. It is used to measure leakage currents up to 300 mA. This requires a voltmeter with an internal resistance $> 1 \text{ M}\Omega/\text{V}$ and a measuring range for AC voltages of $U_{\text{eff}} = 1 \text{ mV}$ to 2 V. For the fault-free operation of an RCCB, the measured leakage current should be no greater than 1/3 of the rated residual current.

Technical specifications

		Auxiliary switches (AS) 5SW3 30.	Auxiliary switches (AS) 5SW3 330
Standards		IEC/EN 60947-5-1	
Approvals		DIN VDE 0660-200	
Terminals			
• Conductor cross-section	mm ²	0.75 ... 2.5	
• Tightening torques	Nm	0.6 ... 0.8	
Short-circuit protection		B6 or C6 or gL/gG 6 A fuse	
Min. contact load		50 mA/24 V	
Max. contact load			
• 230 V AC, AC-12	A	6	5
• 230 V AC, AC-14	A	3.6	--
• 220 V DC, DC-12	A	1	0.5

Additional components

Dimensional drawings

Auxiliary switches (AS)
for RCCBs for 5SM3 up to 80 A

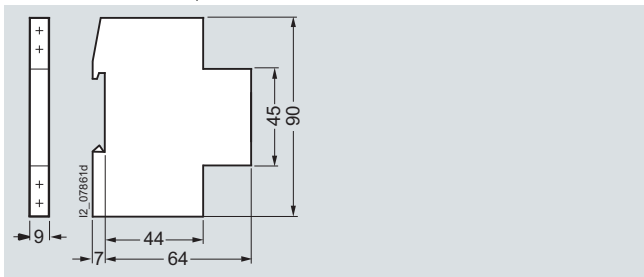

Auxiliary switches (AS) for
RCCBs for 5SM3, 100 A, 125 A, 3P+N

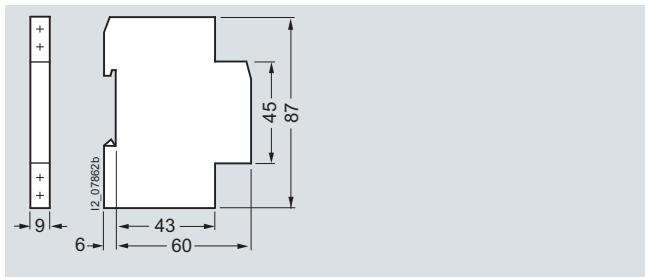

Remote controlled mechanism

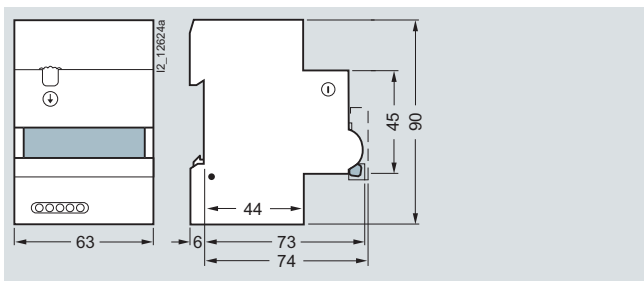

Leakage current measurement devices

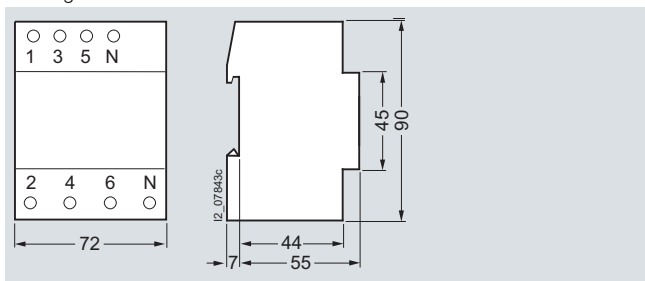

Schematics

Diagrams

Auxiliary switches (AS)
for RCCBs for 5SM3 up to 80 A

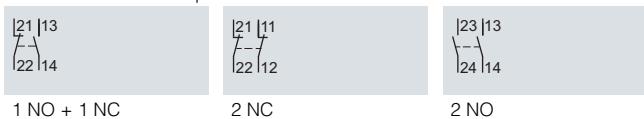

Auxiliary switches (AS) for
RCCBs for 5SM3, 100 A, 125 A, 3P+N



Remote controlled mechanism

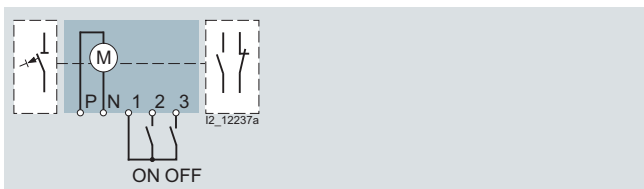

Leakage current measurement devices

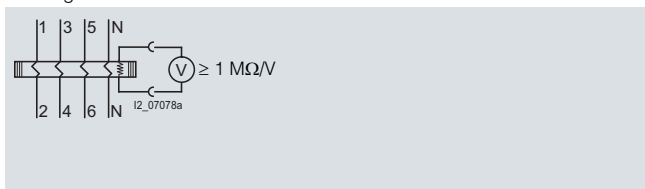

More information

Gossen-Metrawatt offers suitable test devices for RCCB function tests and for testing protective measures.

Information is available at:

Gossen-Metrawatt GmbH
Thomas-Mann-Str. 16-20
D-90471 Nuremberg

Tel. +49 (0)9 11/86 02-111
Fax +49 (0)9 11/86 02-777

www.gmc-instruments.com
email: info@gmc-instruments.com

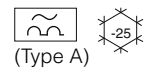

5SM2 RC units, type A

Overview

RC units of type A can be used in all systems up to 240/415 V AC. They trip in the event of both sinusoidal AC residual currents and pulsating DC residual currents.

RCCBs with a rated residual current of maximum 30 mA are used for personnel, material and fire protection, as well as for protection against direct contact.

Devices with a rated residual current of maximum 300 mA are used as preventative fire protection in case of insulation faults.

RC units are combined with miniature circuit breakers with characteristics A, B, C and D, provided that these are available in the MCB range. The two components are simply plugged together without the need for any tools.

They then form a combination of RCCB and MCB for personnel, fire and line protection.

Super resistant



Super resistant (short-time delayed) RC units satisfy the maximum permissible break times for instantaneous devices. However, by implementing a short-time delay they prevent unnecessary trippings, and thus plant faults, when pulse-shaped leakage currents occur - as is the case when capacitors are switched on.

Selective

Can be used as upstream group switch for selective tripping contrary to a downstream, instantaneous or super resistant RCCB.

The dimensioning of the rated residual current depends on the size of the plant.

Technical specifications

		5SM2
Standards		IEC/EN 61009-1 (VDE 0664-20), IEC/EN 61009-2-1 (VDE 0664-21), IEC/EN 61543 (VDE 0664-30)
Approvals		EN 61009-1, EN 61009-2-1; IEC 61009-1, IEC 61009-2-1
Surge current withstand capability with current waveform 8/20 μ s	Acc. to DIN VDE 0432-2	
• Instantaneous	kA	> 1
• Super resistant	kA	> 3
• Selective	kA	> 5
Minimum operational voltage for test function operation		
• Up to $I_n = 63$ A, 2 and 3-pole	V AC	195
• Up to $I_n = 63$ A, 4-pole	V AC	100
• At $I_n = 80 \dots 100$ A	V AC	100
Rated voltage U_n	V AC	230 ... 400
Rated frequency f_n	Hz	50 ... 60
Rated currents I_n	A	0.3 ... 16; 0.3 ... 40; 0.3 ... 63; 80 ... 100
Rated residual currents $I_{\Delta n}$	mA	10, 30, 100, 300, 500, 1000
Insulation coordination • Overvoltage category		III
Terminal conductor cross-sections • Up to I_n 63 A • At $I_n = 80 \dots 100$ A	mm ² mm ²	1.5 ... 25 6.0 ... 50
Terminal tightening torque	Nm	2.5 ... 3.0
Mains connection		Either top or bottom
Mounting position		Any
Degree of protection	Acc. to EN 60529 (VDE 0470-1)	IP20, if the distribution board is installed, with connected conductors
Touch protection	Acc. to EN 50274 (VDE 0660-514)	Finger and back-of-hand safe
Service life	Test cycle acc. to EN 61009	> 10 000 switching cycles
Storage temperature	°C	-40 ... +75
Ambient temperature	°C	-25 ... +45,  marked with 
Resistance to climate	Acc. to IEC 60068-2-30	28 cycles (55 °C; 95 % rel. air humidity)
CFC and silicone-free		Yes

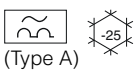

5SM2 RC units, type A

Dimensional drawings

RC units for 5SY

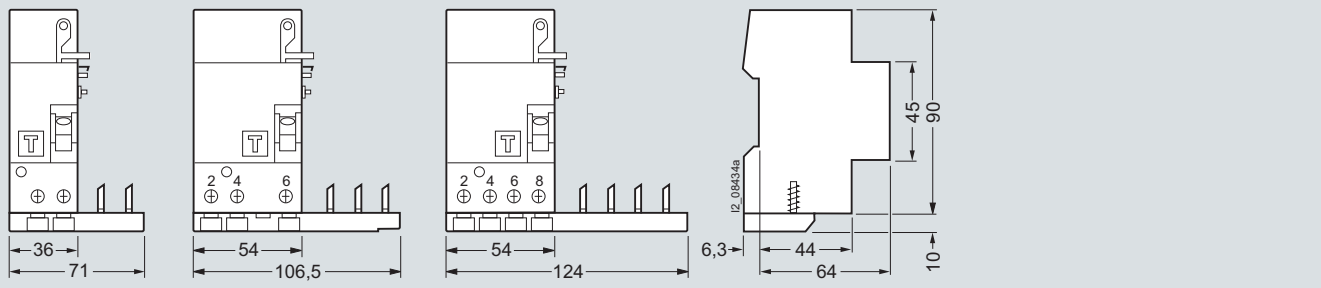

2P

3P

4P

RC units for 5SP4

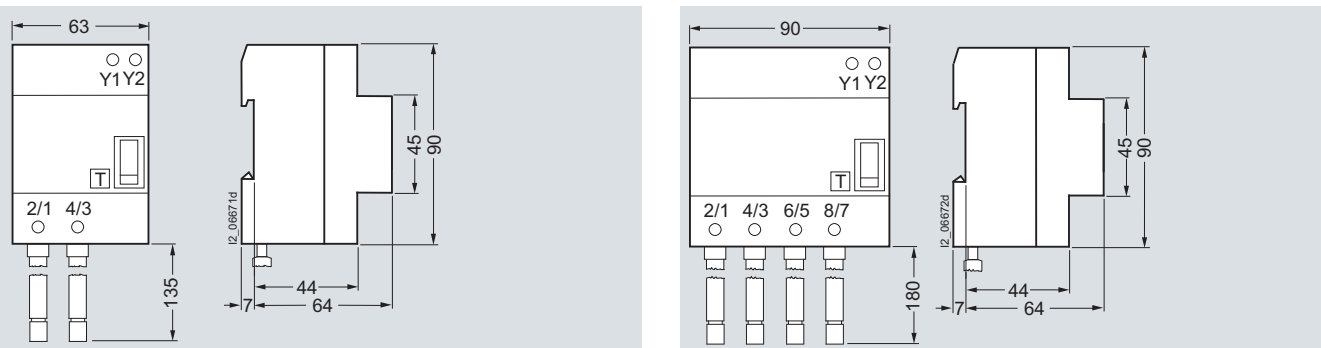

2P

4P

Schematics

Diagrams

RC units for 5SY

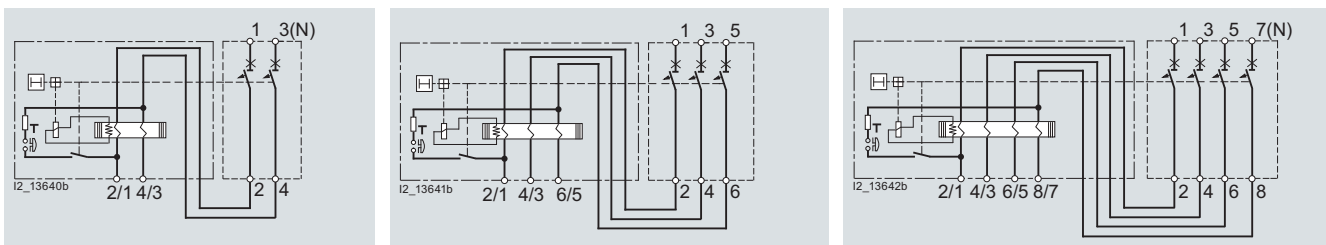

2P

3P

4P

RC units for 5SP4

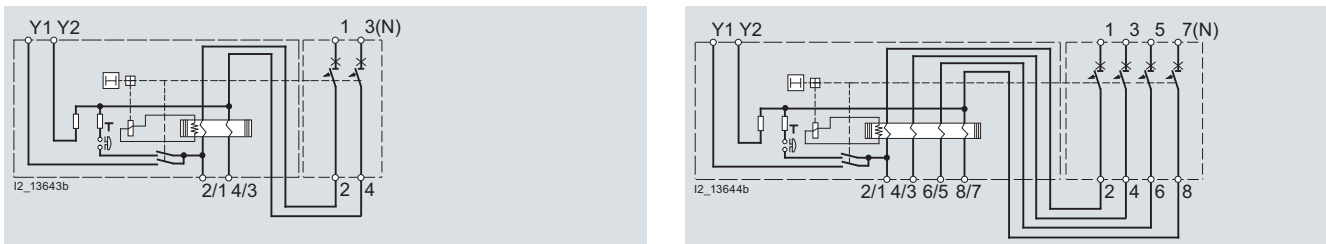

2P

4P

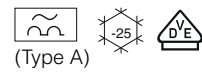

5SU1 RCBOs, type A

Overview

RCBOs are a combination of an RCCB and a miniature circuit breaker in a compact design for personnel, fire and line protection. For personnel and fire protection, the residual current part of the type A trips in the event of sinusoidal AC residual currents and pulsating DC residual currents.

RCBOs with a rated residual current of maximum 30 mA are used for personnel, material and fire protection, as well as for protection against direct contact. RCBOs with a rated residual current of 10 mA are primarily used in areas that represent an increased risk for personnel and the outdoor installations of residential buildings.

Devices with a rated residual current of maximum 300 mA are used as preventative fire protection in case of insulation faults.

The MCB part of the RCBO protects lines against overload and short circuits and is available in characteristics B and C.

Since DIN VDE 0100-410 came into effect in June 2007, all socket outlet current circuits up to 20 A must now also be fitted with residual current protective devices with a rated residual current of max. 30 mA. This also applies to outdoor electrical circuits up to 32 A for the connection of portable equipment.

Technical specifications

		Up to 40 A	125 A
Standards		IEC/EN 61009-1 (VDE 0664-20), IEC/EN 61009-2-1 (VDE 0664-21) IEC/EN 61543; VDE 0664-30	
Approvals		IEC 61009-1, IEC 61009-2-1; EN 61009-1, EN 61009-2-1	
Rated voltages U_n	V AC	125 ... 230	400
Rated frequency f_n	Hz	50 ... 60	
Rated currents I_n	A	6, 8, 10, 13, 16, 20, 25, 32, 40	125
Rated residual currents $I_{\Delta n}$	mA	10, 30, 300	30, 300, 1000
Rated switching capacity	kA	6, 10	10
Energy limitation class		3	--
Surge current withstand capability			
With current waveform 8/20 μ s		Acc. to DIN VDE 0432-2	
• Instantaneous	kA	> 1	
• Super resistant	kA	> 3	--
• Selective	kA	> 5	
Minimum voltage for operation of the test equipment	V AC	100	
Insulation coordination			
• Overvoltage category		III	
Terminal conductor cross-sections			
• Solid and stranded	mm ²	0.75 ... 35	6 ... 50
• Finely stranded with end sleeve	mm ²	0.75 ... 25	6 ... 35
Terminal tightening torque	Nm	2.5 ... 3.0	3.0 ... 3.5
Mains connection		Top or bottom	
Mounting position		Any	
Degree of protection	Acc. to EN 60529 (VDE 0470-1)	IP20, if the distribution board is installed, with connected conductors	
Touch protection	Acc. to EN 50274 (VDE 0660-514)	Finger and back-of-hand safe	
Service life	Test cycle acc. to IEC/EN 61009	Switching cycles	> 10000
Storage temperature	°C	-40 ... +75	
Ambient temperature	°C	-25 ... +45, marked with	
Resistance to climate	Acc. to IEC 60068-2-30	28 cycles (55 °C; 95 % rel. air humidity)	
CFC and silicone-free		Yes	

5SU1 RCBOs, type A

Characteristic curves

Tripping characteristics according to EN 61009-1 (VDE 0664 Part 20)

Tripping characteristic B

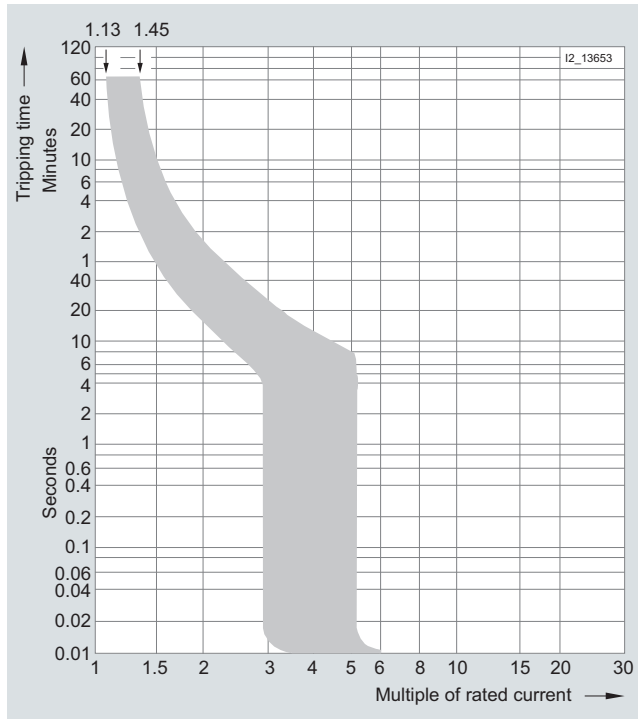

Line protection mainly in outlet circuits; no proof required regarding personal safety.

Tripping characteristic C

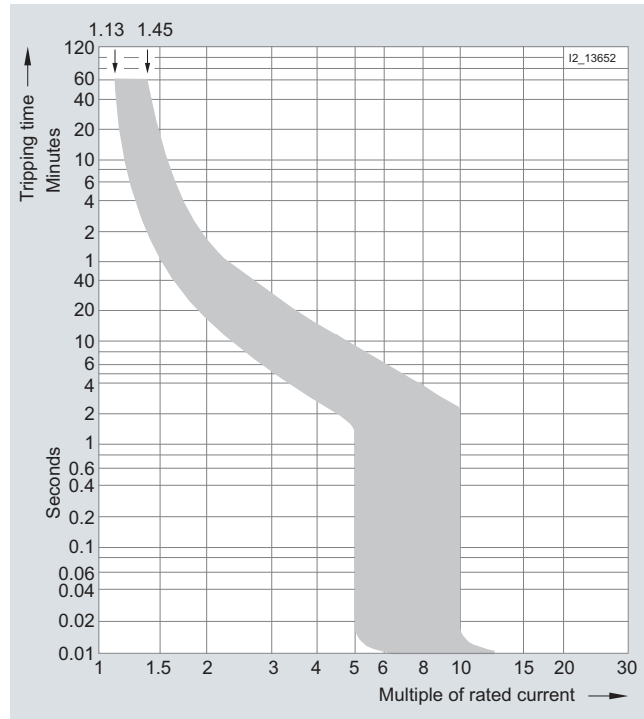

General line protection, especially advantageous with higher starting currents (lamps, motors, etc.)

Tripping characteristics at ambient temperature 30 °C

Tripping characteristic	Standards	Thermal trips				Electromagnetic trips		
		Limiting Test current	Minimum Test current	Tripping time $I_n \leq 63 \text{ A}$	$I_n > 63 \text{ A}$	Hold	Latest tripping instant	Tripping time
		I_1	I_2	t		I_4	I_5	t
B	IEC/EN 61009-1 VDE 0664 Part 20	$1.13 \times I_n$	$1.45 \times I_n$	$> 1 \text{ h}$	$> 2 \text{ h}$	$3 \times I_n$	$5 \times I_n$	$\geq 0.1 \text{ s}$
				$< 1 \text{ h}$	$< 2 \text{ h}$			$< 0.1 \text{ s}$
C		$1.13 \times I_n$	$1.45 \times I_n$	$> 1 \text{ h}$	$> 2 \text{ h}$	$5 \times I_n$	$10 \times I_n$	$\geq 0.1 \text{ s}$
				$< 1 \text{ h}$	$< 2 \text{ h}$			$< 0.1 \text{ s}$

In the case of an ambient temperature other than 30 °C, the current values of the delayed tripping operation change by approx. 5 % per 10 K temperature difference. They rise in case of temperatures lower than 30 °C and fall in case of temperatures higher than 30 °C.

If more than one electrical circuit is loaded in a series of MCBs or RCBOs, the resulting increase in ambient temperature affects the characteristic curve.

In this case, it is necessary to take into account an additional correction factor, specific to the rated current of the RCBOs.

Number	1	2 ... 3	4 ... 6	> 7
Correction factor K	1.00	0.90	0.88	0.85

Switching capacity

Particular demands are made on the MCB part of the RCBO with regard to switching capacity.

The values are standardized and are determined according to the test conditions of EN 61009-1 (VDE 0664 Part 20).

The most common values are 6 000 and 10 000.

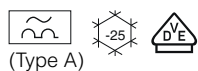

(Type A)

Current protective devices

5SU1 RCBOs, type A

Let-through I^2t -values

Rated switching capacity 5SU1, 6000 A

Characteristic B

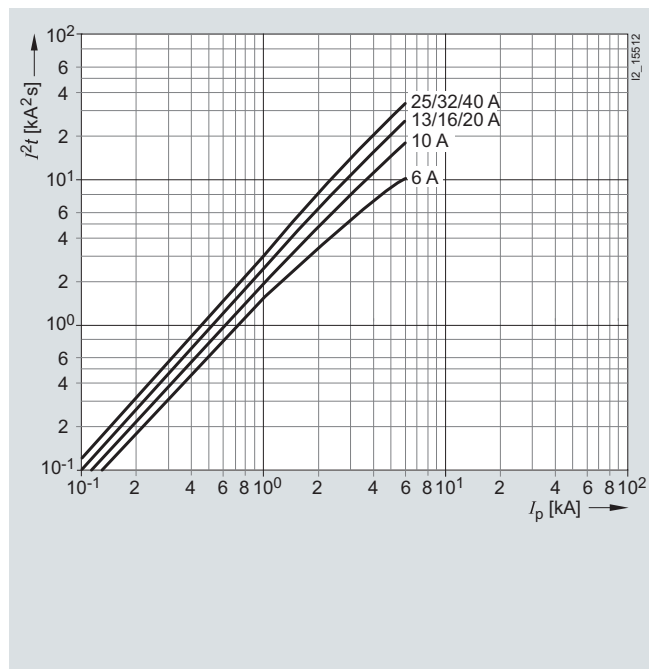

Characteristic C

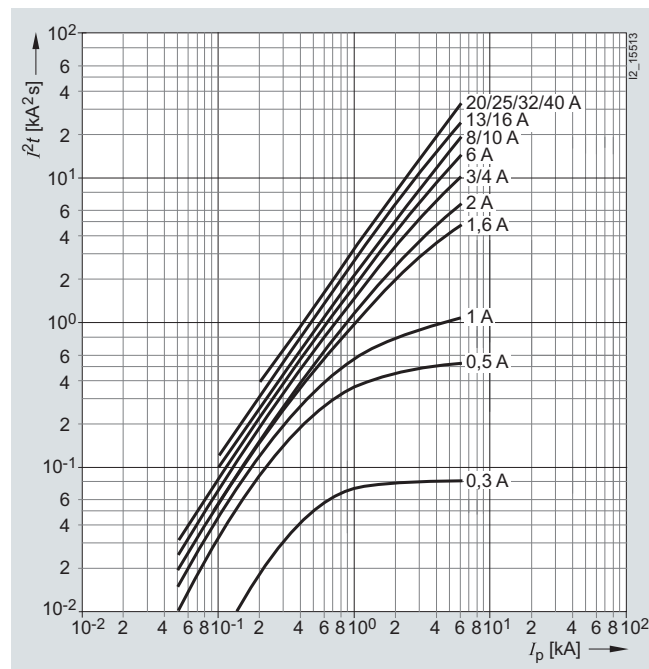

Rated switching capacity 5SU1, 10000 A

Characteristic B

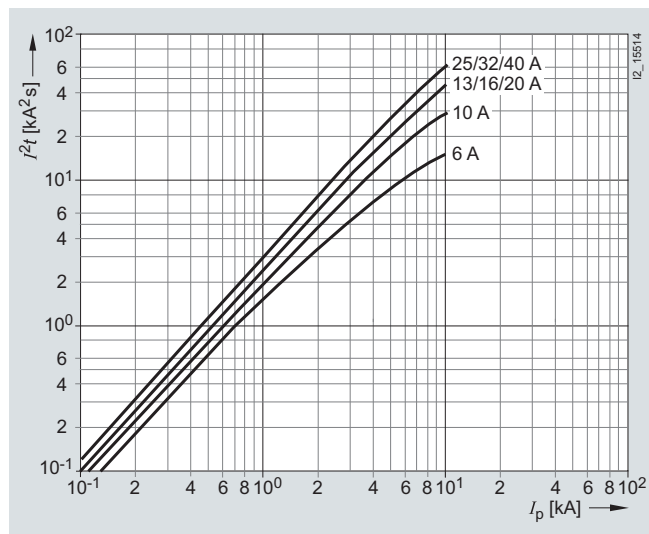

Characteristic B

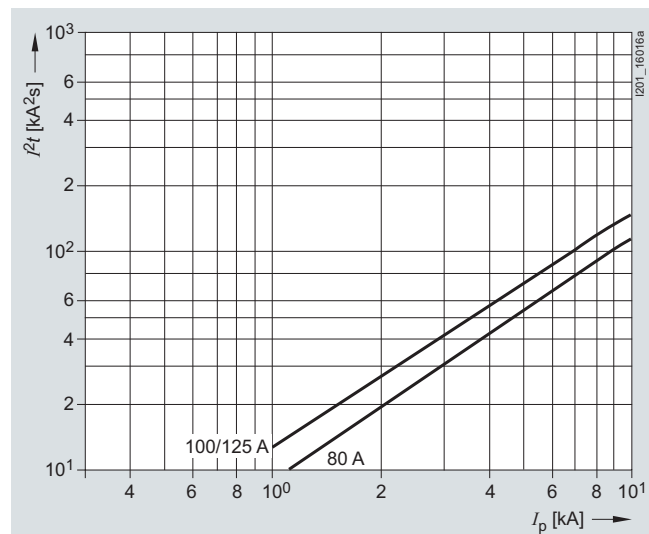

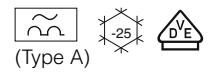

5SU1 RCBOs, type A

Rated switching capacity 5SU1, 10000 A
Characteristic C

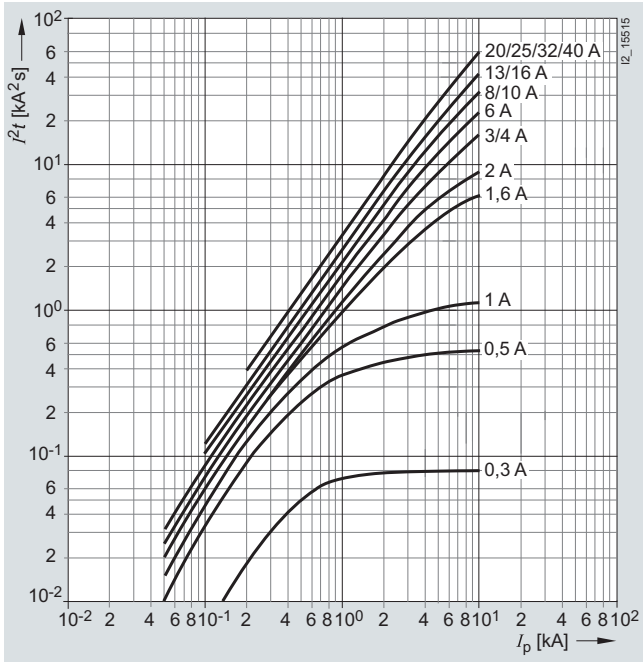

Characteristic C

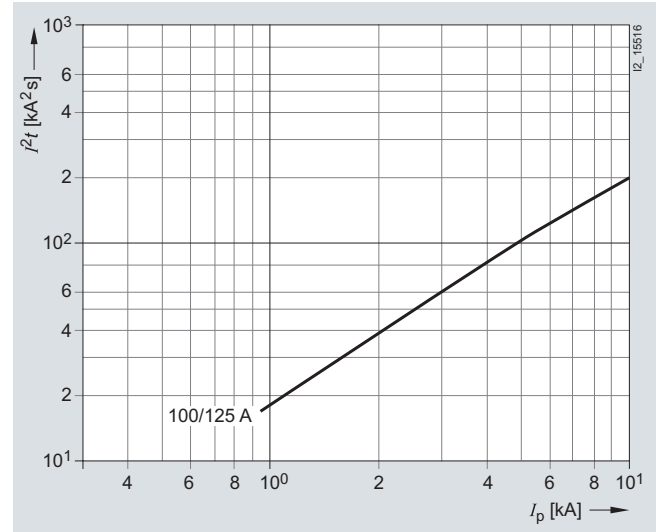

Characteristic D

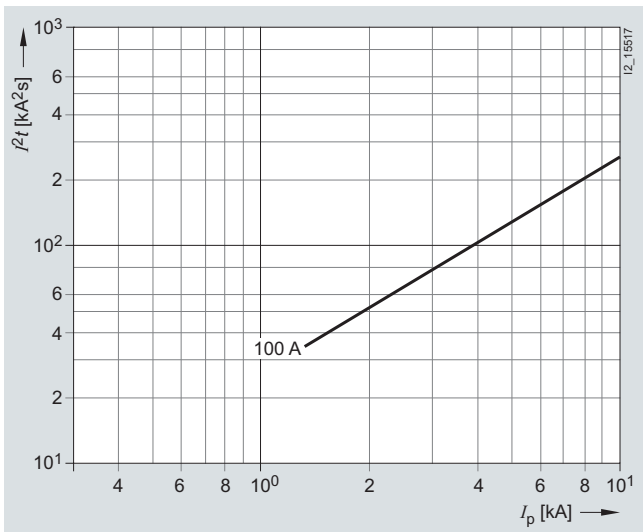

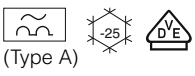

5SU1 RCBOs, type A

Dimensional drawings

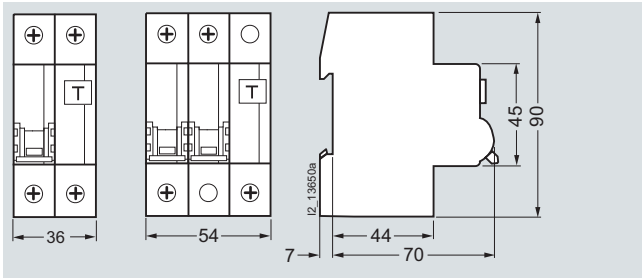

1P+N, up to 40 A
2P, up to 40 A

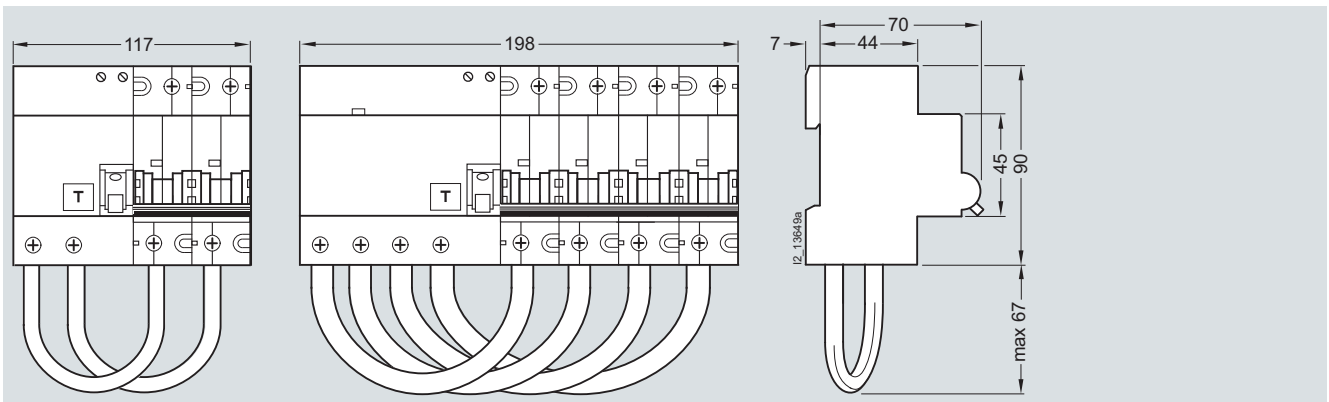

2P, 125 A
4P, 125 A

Handle coupler

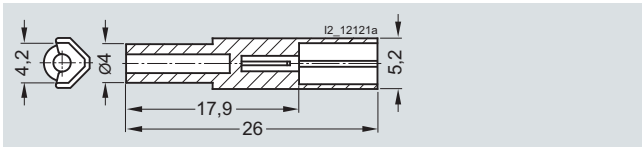

Schematics

Diagrams

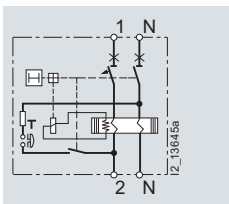

1P+N, up to 40 A

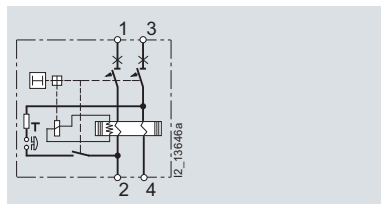

2P, up to 40 A

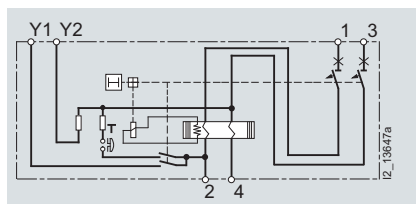

2P, 125 A

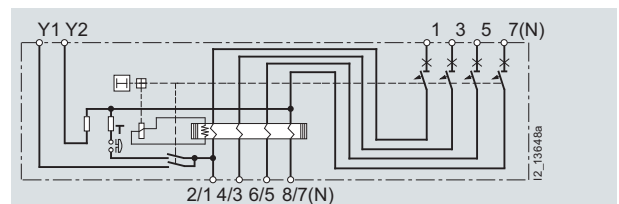

4P, 125 A

5SU1 RCBOs, type A

More information

Selectivity of RCBOs/fuses

Distribution systems are usually set up as radial networks. An overcurrent protection device is required for each reduction of the conductor cross-section. This produces a series connection staggered according to rated currents, which should, if possible, be "selective".

Selectivity means that, in the event of a fault, only the protective device that is directly next to the fault in the current circuit is tripped. This means that current paths in parallel can maintain a power flow.

In the case of RCBOs with upstream fuses, the selectivity limit depends largely on the current limitation and tripping characteristics of the RCBO and the melting I^2t value of the fuse.

This produces different selectivity limits for RCBOs with different characteristics and rated switching capacity.

The following tables provide information on the short-circuit currents up to which selectivity exists between RCBOs and upstream fuse according to DIN VDE 0636 Part 21. The values specified in kA are limit values that were determined under unfavorable test conditions. Under normal practical conditions, you can often expect considerably better values, depending on the upstream fuses.

Limit values of selectivity of RCBOs/fuses in kA

Downstream RCBOs	I_n [A]	Upstream fuses								
		16 A	20 A	25 A	35 A	50 A	63 A	80 A	100 A	125 A
Characteristic B 5SU1 .56	6	0.4	0.7	1.1	2.0	4.1	•	•	•	--
	10	--	0.5	0.75	1.4	2.4	3.4	4.2	•	--
	13	--	0.45	0.7	1.3	2.0	2.7	3.6	•	--
	16	--	0.45	0.7	1.3	2.0	2.7	3.6	•	--
	20	--	--	0.7	1.3	2.0	2.7	3.6	•	--
	25	--	--	--	1.3	2.0	2.7	3.6	•	--
	32	--	--	--	--	2.0	2.7	3.6	•	--
	40	--	--	--	--	1.8	2.7	3.6	•	--
	Characteristic C 5SU1 .56	6	0.35	0.55	0.8	1.5	2.8	4.7	•	•
8		--	0.45	0.7	1.4	2.3	3.3	4.2	•	--
10		--	0.45	0.7	1.4	2.3	3.3	4.2	•	--
13		--	0.4	0.6	1.2	2.0	3.0	3.5	•	--
16		--	0.4	0.6	1.2	2.0	3.0	3.5	•	--
20		--	--	0.6	1.2	2.0	3.0	3.5	•	--
25		--	--	--	1.2	2.0	3.0	3.5	•	--
32		--	--	--	--	2.0	2.8	3.5	•	--
40		--	--	--	--	1.8	2.8	3.5	•	--

• $\hat{=}$ rated switching capacity according to EN 61009-1 6 000

Characteristic B 5SU1 .54	6	0.45	0.7	1.1	2.2	5.0			•	•
	10	--	0.55	0.8	1.5	2.8	4.6	7.0	•	•
	13	--	0.5	0.75	1.4	2.3	3.9	6.0	•	•
	16	--	0.5	0.75	1.4	2.3	3.9	6.0	•	•
	20	--	--	0.75	1.4	2.3	3.9	6.0	•	•
	25	--	--	--	1.2	2.0	3.1	4.5	8.0	•
	32	--	--	--	--	2.0	3.1	4.5	8.0	•
Characteristic C 5SU1 .54	6	0.4	0.6	0.9	1.7	3.3	6.5	•	•	•
	8	--	0.5	0.8	1.5	2.7	5.0	7.0	•	•
	10	--	0.5	0.8	1.5	2.7	5.0	7.0	•	•
	13	--	0.5	0.7	1.3	2.3	4.0	5.0	•	•
	16	--	0.5	0.7	1.3	2.3	4.0	5.0	•	•
	20	--	--	0.6	1.2	2.0	3.2	4.4	8.0	•
	25	--	--	--	1.2	2.0	3.2	4.4	8.0	•
	32	--	--	--	--	1.8	2.8	3.6	7.0	•
	40	--	--	--	--	1.8	2.8	3.6	7.0	•

• $\hat{=}$ rated switching capacity according to EN 61009-1 10 000

Overview

4-pole 5SM3 RCCBs are bus-mounted either together or in combination with miniature circuit breakers. RCCBs with an N wire connection on the left-hand side facilitate installation because standard busbars are used, as those used for bus-mounting miniature circuit breakers.

Busbars in 10 mm² and 16 mm² versions are available.

The extremely flexible 5ST3 6 busbar system with fixed lengths enables installation in any length as the busbars can be overlapped.

No further need for time-consuming tasks, such as cutting, cutting to length, deburring, cleaning of cut surfaces and mounting of end caps.

Any free pins on the busbars can be made safe by covering with touch protection.

If several RCBOs are bus-mounted together, this is implemented with two-phase busbars, which are used as 1+N busbars.

Technical specifications

		5ST3, 5ST2	
Standards		EN 60439-1 (VDE 0660-500): 2005-01	
Busbar material		SF-Cu F 24	
Partition material		Plastic, Cycloy 3600 Heat-resistant over 90 °C flame-retardant and self-extinguishing, dioxin and halogen-free	
Rated operational voltage U_e	V AC	400	
Rated current I_n			
• Cross-section 10 mm ²	A	63	
• Cross-section 16 mm ²	A	80	
Rated impulse withstand voltage U_{imp}	kV	4	
Test pulse voltage (1.2/50)	kV	6.2	
Rated conditional short-circuit current I_{cc}	kA	25	
Resistance to climate			
• Constant atmosphere	Acc. to DIN 50015	23/83; 40/92; 55/20	
• Humid heat	Acc. to IEC 68-2-30	28 cycles	
Insulation coordination	Acc. to IEC 664 (VDE 0110-1)		
• Overvoltage category		III	
• Pollution degree		2	
Maximum busbar current I_S/phase			
• Infeed at the start of the busbar			
- Cross-section 10 mm ²	A	63	
- Cross-section 16 mm ²	A	80	
• Infeed at the center of the busbar			
- Cross-section 10 mm ²	A	100	
- Cross-section 16 mm ²	A	130	

Infeed at the start or end of the busbar

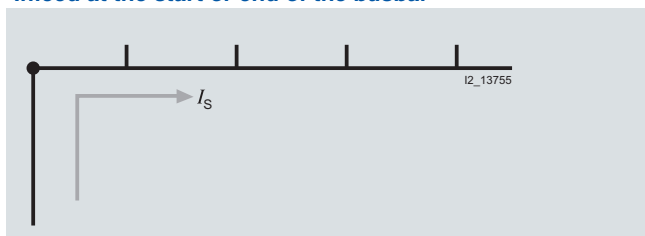

Infeed along the busbar or midpoint infeed

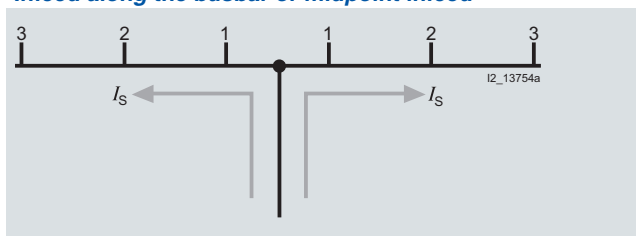

The sum of the output current per branch (1, 2, 3 ... n) must not be greater than the max. busbar current I_S /phase.

Current protective devices

Busbars

Dimensional drawings

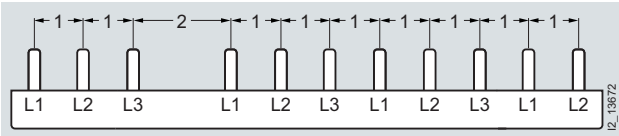

5ST3 624

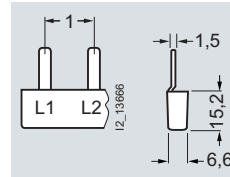
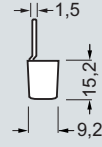

5ST3 608

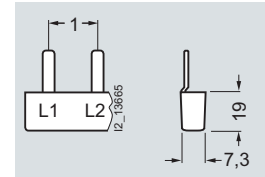

5ST3 638

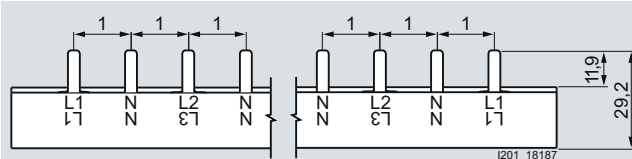

5ST3 770-2

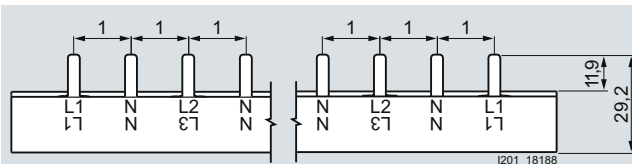
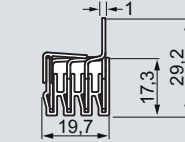

5ST3 770-3

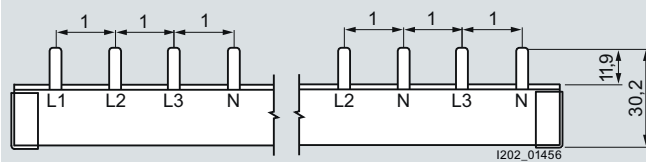
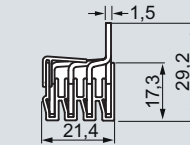

5ST3 770-4

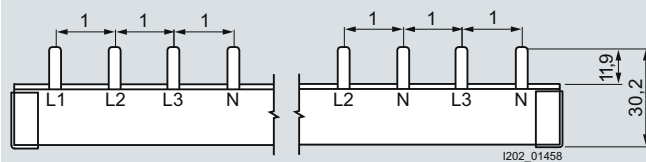
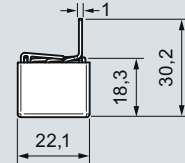

5ST3 770-5

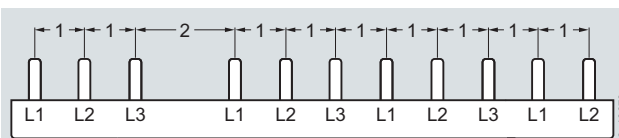
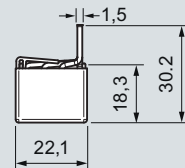

5ST3 654

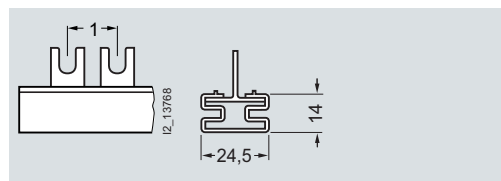
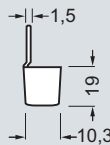

5ST2 145

Note:

Pin spacing in MW
Dimensions of side views in mm (approx.).

Further busbars can also be found in technology manual for miniature circuit breakers.

Overview

	Number of poles	Rated current I_n A	Rated residual current $I_{\Delta n}$ mA	 (Type A)
RCCB protective socket outlets				
• For mounting onto device box, equipped with RCCB and two SCHUKO socket outlets	2	16	10, 30	✓
• Molded-plastic enclosures, equipped with RCCB and SCHUKO socket outlet	2	16	10	✓

 = Type A for AC and pulsating DC residual currents

Dimensional drawings

5SM1 920 RCCB protective socket outlets

According to VDE 0664 for mounting on device boxes, equipped with residual current operated circuit breaker and two childproof **SCHUKO** socket outlets

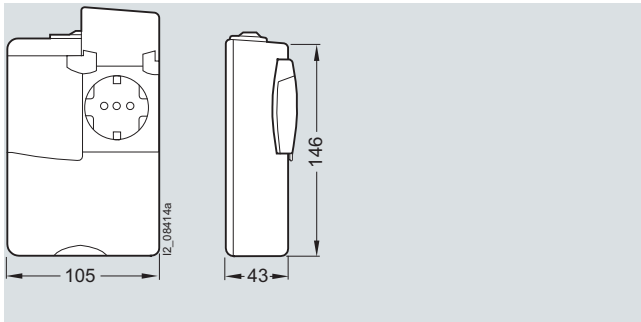

5SZ9 2.6 RCCB protective socket outlets, 5SW1 200 molded-plastic enclosure

Molded-plastic enclosures, equipped with RCCB and flush-mounting **SCHUKO** socket outlets.

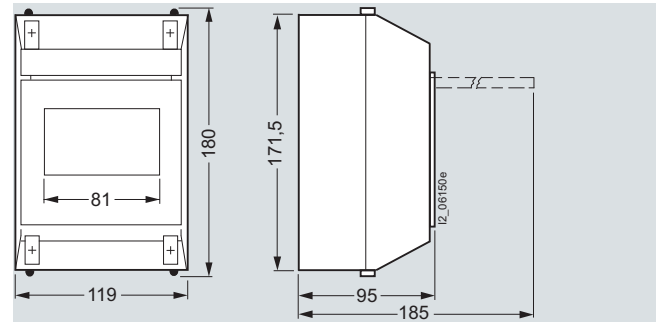

Current protective devices

Residual-current operated circuit breakers

Overview

Protection over residual current protective devices

In the case of "automatic disconnection of the power supply" by means of a residual current protective device, it is essential that the system components and equipment to be protected are fitted with an appropriately grounded PE conductor. This means that it is only possible for a person to be subjected to a flow of current if two faults occur (in addition to an insulation fault, the interruption of the PE conductor) or in the event of accidental contact with live parts.

Additional protection (protection against direct contact) with $I_{\Delta n} \leq 30 \text{ mA}$

Direct contact refers to a situation where a person comes into direct contact with a part that is live under operating conditions. If a person directly touches live parts, two series-connected resistors determine the level of the current - the internal resistance of the person R_m and the contact resistance of the location R_{st} .

For a proper assessment of the accident risk, it must be assumed that the contact resistance of the location is virtually zero.

The resistance of the human body depends on the current path and the contact resistance of the skin. Measurements have shown, for example, that a current path of hand/hand or hand/foot has a resistance of approx. 1000 Ω .

Based on this assumption, a touch voltage of 230 V would produce a dangerous leakage current of 230 mA. The illustration "Areas of impact of alternating current 50/60 Hz on the human body" shows the current intensity/contact time curve in reference to the physiological reactions on the human body. The dangerous values are the current/ contact time values in range 4, as they can trigger ventricular fibrillations, which can cause death.

It also shows the tripping ranges of the residual current protective devices with rated residual current 10 mA and 30 mA and the max. permissible tripping times according to VDE 0664-10. As can be seen from the tripping curve, residual current protective devices do not restrict the level of the fault current, rather they have a protective effect due to the fast disconnection of the current, and thus short contact time.

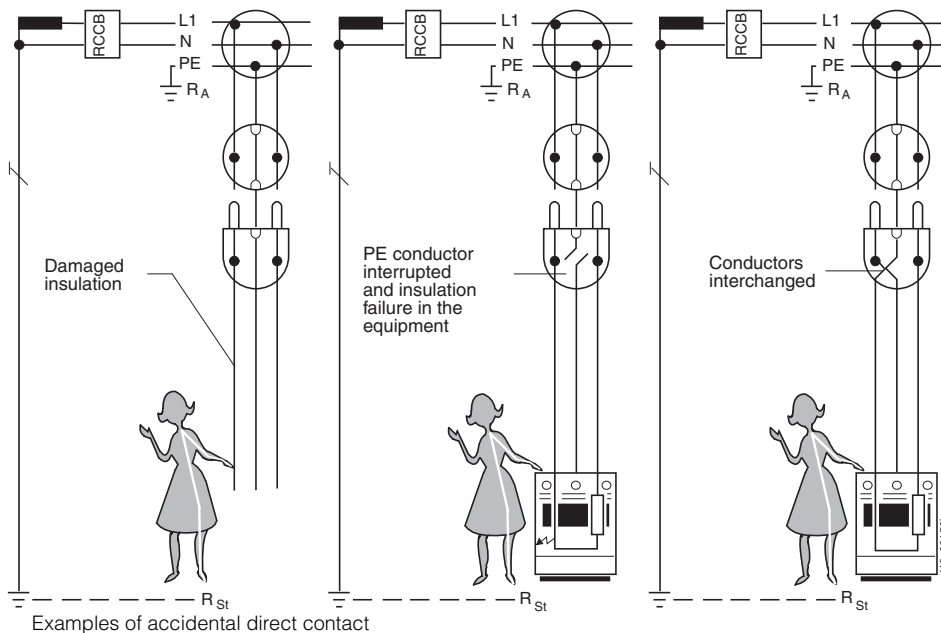
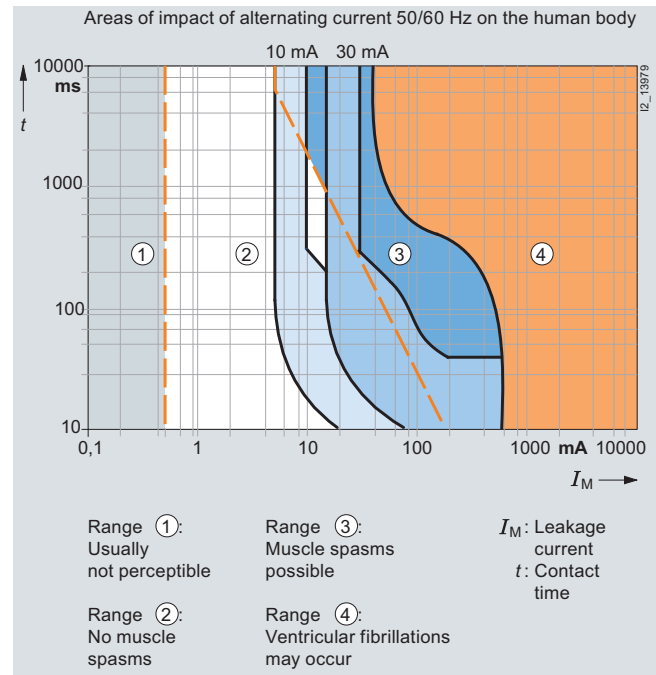

Residual current protective devices with a rated residual current $I_{\Delta n} \leq 10 \text{ mA}$ have a tripping characteristic in range 2 below the let-go current. There are generally no injurious effects or muscle spasms (see illustration). They are therefore suitable for sensitive areas, such as bathrooms.

Residual-current operated circuit breakers

- In the case of negligence on the part of the user (e.g. use of defective devices, inexperienced repairs to systems and/or equipment)
- In the case of contact with faulty live parts (e.g. failure of leakage protection in the event of interruption of the protective conductor)

The use of residual current protective devices with rated residual current of up to 30 mA has proven an effective enhanced protection in the event of failure of basic protection measures (protection against direct contact) and/or fault protection measures (protection against indirect contact), as well as in the case of negligence on the part of the user when handling electrical equipment. However, this must not be the sole means of protection against electric shock. This does not replace the need for further protective measures as required by DIN VDE 0100-410.

The requirement for "enhanced protection" with residual current protective devices according to sections 411.3.3 and 415.1 of DIN VDE 0100-410 does not mean that the application of this protection is optional. Rather, it means that this enhanced protection may be required in relation to external influences and in specific areas in coordination with further protective measures.

In several parts of the standards for Groups 4 and 7 of DIN VDE 0100, this additional protection is required or explicitly recommended. The following explains some of the key requirements.

The general building standard for protection against electric shock, DIN VDE 0100-410:2007-06 requires the use of residual current protective devices with rated residual current ≤ 30 mA for

- All socket outlets with a rated current ≤ 20 A if they are intended for use by non-experts and for general use.
- Branch circuits for portable tools and equipment used outdoors with a rated current ≤ 32 A.

Note:

While DIN VDE 0100-410:06-2007 specifies two exceptions to these requirements, these are not generally applicable to the majority of applications.

The standard does not specify enhanced protection for socket outlets that are used solely by electrical engineers and persons with electrical training (e.g. in electrical workshops) or if it is ensured that the socket outlet is permanently used solely for "specific equipment".

The standard DIN VDE 0100-723:2005-06 "Requirements for special installations or locations - class-rooms with experimental equipment" stipulates that, for the supply of experimental equipment and their circuits, the TN or TT systems must be fitted with residual current protective devices, type B, with rated residual current ≤ 30 mA.

Leakage protection (protection against indirect contact)

Indirect contact refers to the electric contact of persons with a conductive part which is not normally live under operating conditions but has become live under fault conditions. In such cases, it is essential that the power supply is automatically disconnected if a fault means that the level and duration of the touch voltage could pose a risk.

For this purpose, residual current protective devices with a rated residual current of over 30 mA are also suitable. Compliance with the trip conditions is essential in order to ensure sufficient protection. Taking into account the grounding resistance and the rated residual current, the dangerous touch voltage must not persist for a time sufficient to cause a risk of harmful physiological effect in a person.

Fire protection

DIN VDE 0100-482 requires measures to be taken to prevent fires in "Locations exposed to fire hazards" that may result from insulation faults. This stipulates that cables and conductors in TN and TT systems must be protected by means of residual current protective devices with a rated residual current of $I_{\Delta n} = 300$ mA. This does not include mineral-insulated cables and busbar systems.

In the case of applications where resistance-related faults may cause a fire (e.g. ceiling heating with panel heating elements), the rated residual current must be $I_{\Delta n} = 30$ mA.

Protection against fires provided by separate residual current protective devices should not be solely restricted to locations exposed to fire hazards, but universally implemented.

Current protective devices

Residual-current operated circuit breakers

Used in

Residual current protective devices can be used in all three system types (DIN VDE 0100-410).

In the IT system, tripping is not required for the first fault as this situation cannot produce any dangerous touch voltages. It is essential that an insulation monitoring device is fitted so that the first fault is indicated by an acoustic or visual signal and the fault can be eliminated as quickly as possible. Tripping is not requested until the 2nd fault. Depending on the grounding situation, the trip conditions of the TN or TT system must be complied with. A residual current protective device is also a suitable circuit-protection device, whereby a separate residual current protective device is required for each piece of current-using equipment.

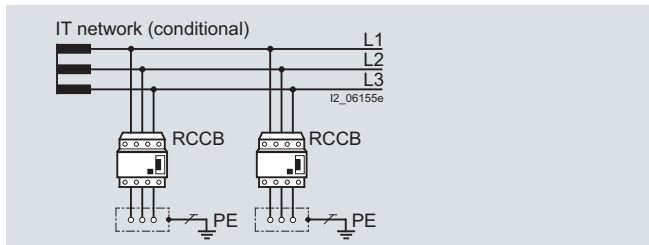
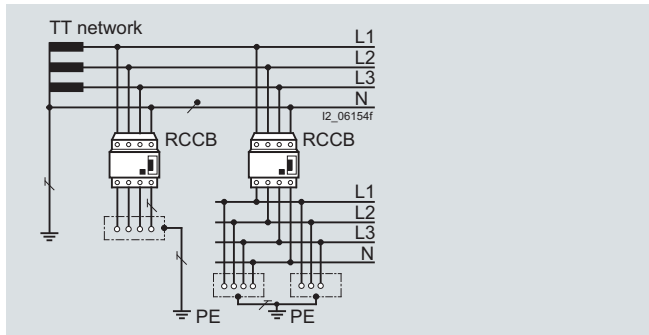
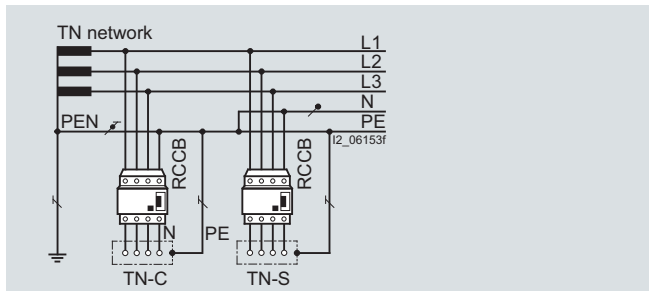

Grounding resistances

When using residual current protective devices in a TT system, the maximum grounding resistances (as shown in the following table) must be complied with, depending on the rated residual current and the max. permissible touch voltage.

Rated residual current $I_{\Delta n}$	Max. permissible grounding resistance at a max. permissible touch voltage of	
	50 V	25 V
10 mA	5000 Ω	2500 Ω
30 mA	1660 Ω	830 Ω
100 mA	500 Ω	250 Ω
300 mA	166 Ω	83 Ω
500 mA	100 Ω	50 Ω
1 A	50 Ω	25 Ω

Setup and method of operation of residual current protective devices

The setup of residual current protective devices is largely determined by 3 function groups:

- 1) Summation current transformers for fault-current detection
- 2) Releases to convert the electrical measured quantities into a mechanical tripping operation
- 3) Breaker mechanism with contacts.

The summation current transformer covers all conductors required to conduct the current, i.e. also the neutral conductor where applicable.

In a fault-free system, the magnetizing effects of the conductors through which current is flowing cancel each other out for the summation current transformer as the sum of all currents is zero (as defined in Kirchhoff's current law). There is no residual magnetic field left that could induce a voltage in the secondary winding.

However, by contrast, if a residual current is flowing due to an insulation fault, this destroys the equilibrium and a residual magnetic field is left in the core of the converter. This generates a voltage in the secondary winding, which then uses the release and the breaker mechanism to switch off the electrical circuit afflicted by the isolation fault.

This tripping principle operates independently of the supply voltage or an auxiliary power supply. This is also a condition for the high protection level provided by residual current protective devices according to IEC/EN 61008 (VDE 0664).

Only this way can it be ensured that the full protective action of the residual current protective device is maintained even in the event of a system fault, e.g. failure of an outer conductor or an interruption in the neutral conductor.

Test button

All residual current protective devices are equipped with a test button. Simply press this button to test whether the residual current protective device is ready to run. Pressing the test button generates an artificial residual current – the residual current protective device must trip.

We recommend testing the functionality when commissioning the system and then at regular intervals – approx. every six months.

Furthermore, it is also essential to ensure compliance with the test intervals specified in the pertinent rules and regulations (e.g. accident prevention regulations).

The minimum operational voltage for operation of the test equipment is 100 V AC (series 5SM3)¹⁾.

¹⁾ For detailed information, see Technical specifications.

3-pole connection

4-pole residual current protective devices can also be operated in 3-pole systems. In this case, connection must be at terminals 1, 3 and 5 and 2, 4 and 6.

The function of the test equipment is only ensured if a jumper is fitted between terminals 3 and N.

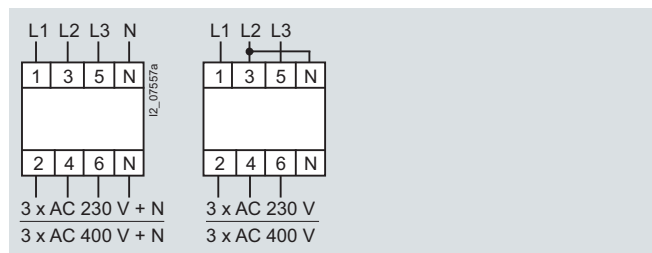

SIGRES RCCBs for severe ambient conditions

Our SIGRES RCCBs have been developed for use in environments with increased pollution gas loads, such as

- Indoor swimming pools: chlorine gas atmosphere
- Agriculture: ammonia
- Worksite distribution boards, chemical industry: nitrogen oxides [NO_x], sulfur dioxide [SO₂]

A significant increase in service life is achieved using our patented active condensation protection.

When using SIGRES RCCBs, the following points must be observed:

- The infeed must always be from below, from terminals 2/N or 2/4/6/N.
- Before carrying out insulation tests on installation systems with voltages greater than 500 V, the SIGRES RCCB must be switched off or the cables on the input side (underneath) must be disconnected.

Short-time delayed tripping, super resistant **K**

Electrical loads that temporarily produce high leakage currents when they are switched on (e.g. temporary residual currents flowing through interference-suppression capacitors between outer conductor and PE) may trip instantaneous residual current protective devices, if the leakage current exceeds the rated residual current $I_{\Delta n}$ of the residual current protective device.

Short-time delayed, super resistant residual current protective devices can be installed for this type of application, where it is not possible, or only partially possible, to eliminate such interference sources. These devices have a minimum tripping delay of 10 ms, i.e. they should not trip for a residual current pulse of 10 ms. This complies with the maximum permissible break times according to IEC/EN 61008-1 (VDE 0664-10). The devices have a high surge current withstand capability of 3 kA.

Short-time delayed, super-resistant residual current protective devices has the identification code **K**.

Selective tripping **S**

Residual current protective devices normally have an instantaneous tripping operation. This means that a series connection of this type of residual current protective devices does not provide selective tripping in the event of a fault. In order to achieve selectivity for a series connection of residual current protective devices, both the tripping time and the rated residual current of series-connected devices must be time graded. Selective residual current protective devices have a tripping delay.

Furthermore, selective residual current protective devices must have an increased surge current withstand capability of at least 3 kA according to IEC/EN 61008-1 (VDE 0664-10). Siemens devices have a surge current withstand capability of ≥ 5 kA.

Selective residual current protective devices has the identification code **S**.

The table below shows the time grading options available for residual current protective devices for selective tripping in series connection with devices without time delay and super resistant with short-time delay **K**.

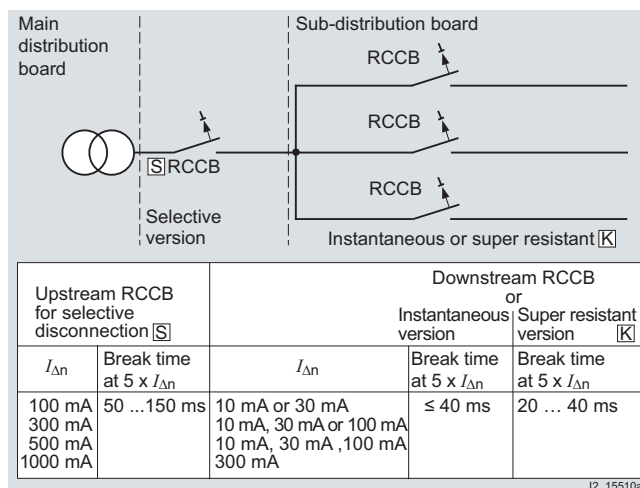
Residual-current operated circuit breakers

¹⁾ For residual current circuit breakers of type AC: <40 ms.

Versions for 50 ... 400 Hz

Due to their principle of operation, the standard versions of residual current protective devices are designed for maximum efficiency in 50/60 Hz systems. Product standards and tripping conditions also refer to this frequency. The sensitivity decreases with increasing frequency. In order to implement an effective fault-current protection for applications in systems up to 400 Hz (e.g. industry), you need to use suitable devices. This type of residual current protective devices fulfills the tripping conditions up to the specified frequency and provides the appropriate level of protection.

Residual current circuit breaker with left-side N-connection

The fact that the RCCBs are usually located to the left of the miniature circuit breakers, but have their N wire connection on the right-hand side, interferes with the integrated busbar connection. For this reason, when used with miniature circuit breakers, RCCBs require a special busbar. In order to enable the use of standard busbars, 4-pole RCCBs are also provided with their N connection on the left-hand side. This means that RCCBs can continue to be installed to the left of miniature circuit breakers using standard busbar connections.

Current protective devices

Residual-current operated circuit breakers

Surge current withstand capability

During thunderstorms, atmospheric overvoltages in the form of traveling waves can penetrate the installations of a system over an overhead system and trip the residual current protective devices.

To prevent such inadvertent tripping operations, residual current protective devices sensitive to power pulse currents must pass specific tests proving its surge current withstand capability. These tests are carried out using a surge current of the standardized surge current wave 8/20 μ s.

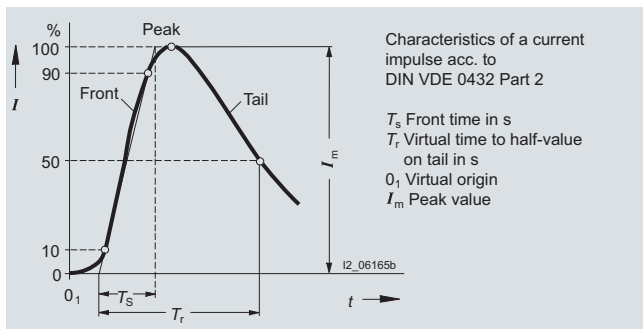

Surge current wave 8/20 μ s (front time 8 μ s; time to half-value 20 μ s)

Siemens residual current protective devices of types A and B all have a high surge current withstand capability. The following table shows the surge current withstand capability of the various versions:

Version	Surge current withstand capability
Instantaneous	> 1 kA
Short-time delayed, super resistant K	> 3 kA
Selective S	> 5 kA

Switching capacity, short-circuit strength

In accordance with the installation regulations DIN VDE 0100-410 (protection against electric shock) residual current protective devices can be installed in three system types (TN, TT and IT systems).

However, if using the neutral conductor as a protection conductor in TN systems, a fault may cause residual currents similar to a short-circuit. For this reason, residual current protective devices must be installed together with a back-up fuse and have the appropriate short-circuit strength. Tests have been defined for this purpose.

The short-circuit strength of the combination must be specified on the devices.

Siemens residual current protective devices, together with a suitable back-up fuse, have a short-circuit strength of 10000 A. This is the highest possible level of short-circuit strength as specified in the VDE regulations.

Data for the rated switching capacity according to IEC/EN 61008, i.e. the maximum permissible short-circuit back-up fuses for residual current protective devices are contained in the following table:

Rated current of the residual current protective device	Rated switching capacity I_m acc. to IEC/EN 61008 (VDE 0664) for a grid distance of 35 mm	Maximum permissible short-circuit back-up fuse, LV HRC, DIAZED, NEOZED operational class gL/gG for residual current protective device	
		125 ... 400 V AC	500 V AC
A	A	A	A
	Type A		
16 ... 40	2 MW 500	63	--
63	2.5 MW 800	100	--
80	2.5 MW 800	100	--
100	2 MW 1000	125	--
125	2 MW 1250	125	--
25 ... 63	4 MW 800	100	63
80	4 MW 800	100	--
100	4 MW 1000	125	--
125	4 MW 1250	125	--
	Type B		
25 ... 80	4 MW 800	100	--

Example:

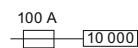

Short-circuit strength 10 kA with max. permissible short-circuit series fuse 100 A.

Residual-current operated circuit breakers











Types of current

Due to the use of electronic components in household appliances and industrial plants, insulation faults can also cause residual currents that are not AC residual currents to flow through residual current protective devices, even in the case of devices with ground terminals (Safety class I).

The regulations for residual current protective devices contain additional requirements and test regulations for residual currents whose power supply frequency is zero or virtually zero within a certain period.

Residual current protective devices that trip for both sinusoidal AC residual currents and pulsating DC residual currents (type A) are identified by the mark .

Residual current protective devices that also trip for smooth DC residual currents (type B) are identified by the mark  .

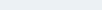
Type of current	Current waveform	Correct function of residual current protective devices of type			Tripping current ¹⁾
		Type AC 	Type A 	Type B   Type B+   kHz	
AC residual current		✓	✓	✓	0.5 ... 1.0 $I_{\Delta n}$
Pulsating DC residual currents (pos. or neg. half-waves)		--	✓	✓	0.35 ... 1.4 $I_{\Delta n}$
Started half-wave currents Start angle 90° el Start angle 135° el		--	✓ ✓	✓ ✓	0.25 ... 1.4 $I_{\Delta n}$ 0.11 ... 1.4 $I_{\Delta n}$
Half-wave current during superimposition with smooth direct current of 6 mA		--	✓	✓	Max. 1.4 $I_{\Delta n}$ + 6 mA
Smooth direct current		--	--	✓	0.5 ... 2.0.1 $I_{\Delta n}$

¹⁾ Tripping currents according to IEC/EN 61008-1 (VDE 0664, Part -10); for smooth DC residual currents defined to IEC 60755 UB1 INT.

Note:

You will find further information on the subject of residual current protective devices in the technology primer "Residual Current Protective Devices", Order No.: E10003-E38-10T-G3011-7600.

Current protective devices

Residual-current operated circuit breakers

Application

Standards	Application	Required $I_{\Delta n}$ [mA]	Recommended Siemens residual current protective devices		
			5SM. (Type A)	5SM3 SIQUENCE (Type B/type B+)	5SM3 ...-6KK12 SIGRES
DIN VDE 0100-410	Socket outlets ≤ 20 A and branch circuits in the outdoor area ≤ 32 A	≤ 30	✓	--	--
DIN VDE 0100-482	Fire protection for particular risks or safety hazard	30, 300	✓	✓	--
DIN VDE 0100-551	Low-voltage generating sets	≤ 30	✓	--	--
DIN VDE 0100-559	Luminaires and lighting installations, display stands for lights	≤ 30	✓	--	--
DIN VDE 0100-701	Rooms with baths or showers, socket outlets in zone 3	≤ 30	✓	--	--
DIN VDE 0100-702	Swimming pools, zone 1 and 2	≤ 30	✓	--	✓
DIN VDE 0100-704	Construction and demolition site installations, socket outlet current circuits (single-phase operation) up to 32 A and for hand-held equipment	≤ 30	✓ ✓	-- ✓	✓ ✓
DIN VDE 0100-705	Agricultural and general horticultural premises	≤ 500	✓	--	✓
	Socket outlet current circuits	≤ 30	✓	--	✓
DIN VDE 0100-706	Conductive areas with limited freedom of movement	≤ 30	✓	--	--
DIN VDE 0100-708	Feeding points for caravan parking spaces, camping sites	≤ 30	✓	--	--
DIN VDE 0100-710	Medical premises, depending on application group 1 or 2 and equipment	≤ 30 or ≤ 300	✓ ✓	✓ ✓	-- --
DIN VDE 0100-722	Portable buildings, vehicles, mobile homes for fairgrounds	≤ 500	--	--	✓
DIN VDE 0100-723	Classrooms with experiment equipment	≤ 30	--	✓	--
DIN VDE 0100-738	Fountains zone 2, general	≤ 500	✓	--	✓
	Socket outlets in zone 2	≤ 30	✓	--	✓
	Zones 0 and 1	≤ 30	✓	--	✓
DIN VDE 0100-739	Additional protection against direct contact in homes	≤ 30	✓	--	--
DIN VDE 0118-100	Mining plants	≤ 500	✓	--	✓
DIN EN 50178 (VDE 0160)	Fitting of power installations with electronic equipment	General requirements for correct selection when using res. current protection	✓	✓	--
DIN VDE 0832-100	Traffic signals				
	• Class T1	≤ 300	✓	--	✓
	• Class U1	≤ 30	✓	--	✓
BG FE BGI 608	Selection and operation of electrical equipment on worksites				
	General:				
	• Socket circuits ≤ 32 A	≤ 30	✓	✓	✓
	• Socket circuits > 32 A	≤ 500	✓	✓	✓
	Frequency-controlled equipment:				
	• with plug-and-socket device ≤ 32 A	≤ 30	--	✓	--
	• with plug-and-socket device > 32 A	≤ 500	--	✓	--
	Chemical industry and food processing industries	30 (recommended)	✓	✓	✓

Note:

For reasons of basic fire protection, we recommend a maximum rated residual current of 300 mA for residual current protective devices.

Siemens AG
Industry Sector
Building Technologies Division
Low Voltage Distribution
Postfach 10 09 53
93009 REGENSBURG
GERMANY

www.siemens.com/lowvoltage

Subject to change without prior notice
PDF only
3P.8303.54.27
PH 0611 30 En
© Siemens AG 2011

The information provided in this configuration Manual contains descriptions or characteristics of performance which in case of actual use do not always apply as described or which may change as a result of further development of the products. An obligation to provide the respective characteristics shall only exist if expressly agreed in the terms of contract. Availability and technical specifications are subject to change without notice.

All product designations may be trademarks or product names of Siemens AG or supplier companies whose use by third parties for their own purposes could violate the rights of the owners.