

Fuse Systems

Configuration Manual · 10/2010



SENTRON

Answers for infrastructure.

SIEMENS







Fuse Systems









4	Introduction
9	NEOZED fuse systems, 5SE2
16	DIAZED fuse systems, 5SA, 5SB, 5SC, 5SD
	Cylindrical fuse systems
26	Cylindrical fuse links and cylindrical fuse holders, 3NW6, 3NW7, 3NW8
35	Compact fuse holders for motor starter combinations, 3NW7
38	Class CC fuse systems, 3NW7, 3NW1, 3NW2, 3NW3
41	Busbar systems, 5ST, 5SH
	LV HRC fuse systems
45	LV HRC fuse links, 3NA, 3ND
48	LV HRC signal detectors, 3NX1
49	LV HRC fuse bases and accessories, 3NH3, 3NG1, 3NX
	SITOR semiconductor fuses
76	LV HRC design, 3NC, 3NE
124	Cylindrical fuse design, 3NC1, 3NC2
135	NEOZED and DIAZED design, SILIZED, 3SE1, 5SD4
139	Configuration
	Photovoltaic fuses
151	Cylindrical fuse design, 3NW7 0, 3NW6 0

Introduction

Overview

Devices	Page	Application	Standards	Used in		
				Non-residential buildings	Residential buildings	Industry
	9	MINIZED switch disconnectors, bases, fuse links from 2 A to 63A of operational class gG and accessories. Everything you need for a complete system.	Fuse system: IEC 60269-3; DIN VDE 0636-3; Safety switching devices IEC/EN 60947-3 DIN VDE 0638; DIN VDE 0660-107	✓	✓	✓
	16	Fuse links from 2 A to 100 A in various operational classes, base versions with classic screw base connections. A widely used fuse system.	IEC 60269-3; DIN VDE 0635; DIN VDE 0636-3; CEE 16	✓	✓	✓
Cylindrical fuse systems						
	26	Line protection or protection of switching devices. The fuse holders with touch protection ensure the safe "no-voltage" replacement of fuse links. Auxiliary switches can be retrofitted	IEC 60269-1, -2, -3; NF C 60-200; NF C 63-210, -211; NBN C 63269-2, CEI 32-4, -12	✓	✓	✓
	35	For installing fused loaded motor starter combinations.	IEC 60947-4	✓	--	✓
	38	These comply with American standard and have UL and SCA approval, for customers exporting OEM products and mechanical engineers. Modern design with touch protection acc. to BGV A3 for use in "branch circuit protection".	Fuse holders: UL 512; CSA 22.2 Fuse links: UL 248-4; CSA 22.2	✓	✓	✓
	41	Busbars for NEOZED fuse bases, NEOZED fuse disconnectors, MINIZED switch disconnectors, DIAZED fuse systems and cylindrical fuse systems.	EN 60439-1 (VDE 0660-500)	✓	✓	✓

Devices	Page	Application	Standards	Used in			
				Non-residential buildings	Residential buildings	Industry	
LV HRC Fuse Systems							
	LV HRC fuse links, 3NA, 3ND	45	Fuse links from 2 A to 1250 A for selective line protection and plant protection in non-residential buildings, industry and power supply companies.	IEC 60269-1, -2; EN 60269-1; DIN VDE 0636-2	✓	✓	✓
	LV HRC signal detectors, 3NX1	48	Signal detectors for when a fuse is tripped on all LV HRC fuse links with combination or front indicators with non-insulated grip lugs. Plus the comprehensive accessory range required for NH fuse systems.		✓	✓	✓
	LV HRC fuse bases and accessories, 3NH3, 3NG1, 3NX	49	Fuse bases for screw or snap-on mounting onto standard mounting rails, available as 1-pole or 3-pole version	IEC 60269-1, -2; EN 60269-1; DIN VDE 0636-2	✓	✓	✓
SITOR semiconductor fuses							
	In LV HRC design, 3NC, 3NE	76	Fuse links in LV HRC design and a huge variety of models support a wide range of applications from 500 V to 1500 V and 150 A to 1250 A. Fuses with slotted blade contacts, bolt-on links or female thread and special designs.		--	--	✓
	In cylindrical fuse design, 3NC1, 3NC2	124	Fuse links, fuse holders – usable as fuse switch disconnectors and fuse bases up to AC 600/690 V and DC 400/700 V from 1 A to 100 A in the sizes 10 mm x 38 mm, 14 mm x 51 mm and 22 mm x 58 mm.		--	--	✓
	In NEOZED and DIAZED design, SILIZED, 3SE1, SSD4	135	NEOZED fuse links for 400 V AC and 250 V DC and DIAZED for 500 V AC and 500 V DC.		--	--	✓
Photovoltaic fuses							
	In cylindrical fuse design, 3NW7 0, 3NW6 0	151	Fuses with a rated voltage of 1000 V DC and gPV operational class for the protection of photovoltaic modules and their connecting cables.	IEC 60269-6 (draft)	✓	✓	✓

Introduction

Overview

Rated voltage U_n

The rated voltage is the designated voltage of the fuse and is used to determine its test conditions and operational voltage limits.

For LV HRC and SITOR fuse links, the rated voltage is always the r.m.s. value of an AC voltage.

In the case of NEOZED and DIAZED fuse links, a distinction is made between AC and DC voltage values.

Rated current I_n

The rated current of a fuse link is the designated current of the fuse link and is the current up to which it can be continuously loaded under prescribed conditions without adverse affects.

Rated frequency

The rated frequency is the frequency for which the fuse link is rated with regard to power dissipation, current, voltage, characteristic curve and breaking capacity.

Selectivity

Several fuses are usually connected in series in one system. And when things get serious, selectivity ensures that only the faulty electrical circuit of a system is switched off and not the entire operational process.

Siemens fuses of operational class gG, at an operational voltage of up to 400 V AC and a ratio of 1:1.25, are interselective, i.e. from rated current level to rated current level. This is achieved by means of the considerably smaller spread of $\pm 5\%$ of the time/current characteristics, which far exceeds the demand for a ratio of 1:1.6 specified in the standard.

It is therefore possible to use smaller conductor cross-sections due to the lower rated currents.

Breaking capacity

The rated breaking capacity is the highest prospective short-circuit current I_p that the fuse link can blow under prescribed conditions.

A key feature of these fuses is their high rated breaking capacity with the smallest footprint. The basic demands and circuit data for tests – voltage, power factor, actuating angle etc. – are specified in both national (DIN VDE 0636) and international (IEC 60269) regulations.

However, for a constant failsafe breaking capacity, from the smallest non-permissible overload current through to the highest breaking current, a number of quality characteristics need to be taken into account when designing and manufacturing fuse links. These include the design of the fuse element with regard to dimensions and punch dimension and its position in the fuse body, as well as its compressive strength and the thermal resistance of the body. The chemical purity, particle size and the density of the quartz sand also play a key role.

The rated breaking capacity for AC voltage for NEOZED- and the majority of DIAZED fuses - is 50 kA, and in the case of our NH fuse systems, it is even 120 kA. The various type ranges of SITOR fuses have different switching capacities ranging from 50 to 100 kA.

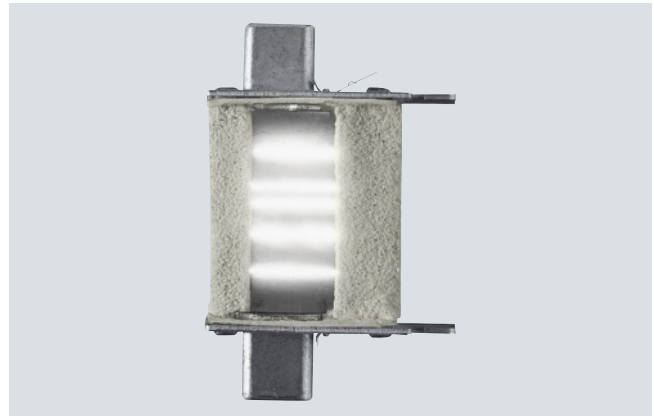

Faster arcing and precise arc quenching are the requirements for a reliable breaking capacity.

Operational classes

Fuses are categorized according to function and operational classes. The first letter defines the function class and the second the object to be protected:

1st letter

a = Partial range protection
(accompanied fuses):

Fuse links that carry currents at least up to their rated current and can switch currents above a specific multiple of their rated current up to their rated breaking current.

g = Full range protection
(general purpose fuses):

Fuse links that can continuously carry currents up to at least their specified rated current and can switch currents from the smallest melting current through to the breaking current. Overload and short-circuit protection.

2nd letter

G = Cable and line protection
(general applications)

M = Switching device protection in motor circuits
(for protection of motor circuits)

R, S = Semiconductor protection/thyristor protection
(for protection of rectifiers)

L = Cable and line protection
(in acc. with the old, no longer valid DIN VDE)

B = Mine equipment protection

Tr = Transformer protection

The designations "slow" and "quick" still apply for DIAZED fuses. These are defined in IEC/CEE/DIN VDE.

In the case of "quick" characteristics, the fuse blows in the breaking range faster than those of the gG operational class.

In the case of DIAZED fuse links for DC railway network protection, the "slow" characteristic is particularly suitable for switching off direct currents with greater inductance. Both characteristics are also suitable for the protection of cables and lines.

Full range fuses (gG, gR, quick, slow) reliably break the current in the event of non-permissible overload and short-circuit currents.

Partial range fuses (aM, aR) exclusively serve short-circuit protection.

The following operational classes are included in the product range:

- gG (DIN VDE/IEC) = Full range cable and line protection
- aM (DIN VFE/IEC) = Partial ranges switching device protection
- aR (DIN VDE/IEC) = Partial range semiconductor protection
- gR (DIN VDE/IEC) = Full range semiconductor protection
- gS (DIN VDE/IEC) = Full range semiconductor protection and cable and line protection
- quick(DIN VDE/IEC/CEE) = Full range cable and line protection
- slow(DIN VDE) = Full range cable and line protection

Characteristic curves (time/current characteristic curves)

The time/current characteristic curve specifies the virtual time (e.g. the melting time) as a function of the prospective current under specific operating conditions.

Melting times of fuse links are shown in the time/current diagrams with logarithmic scale and depending on their currents. The melting time characteristic curve runs from the smallest melting current, which just about melts the fuse element, asymptotic to the I^2t lines of the same joule value in the range of the higher short-circuit currents, which specifies the constant melting heat value I^2t . To avoid overcomplication, the time/current characteristics diagrams omit the I^2t lines (c).

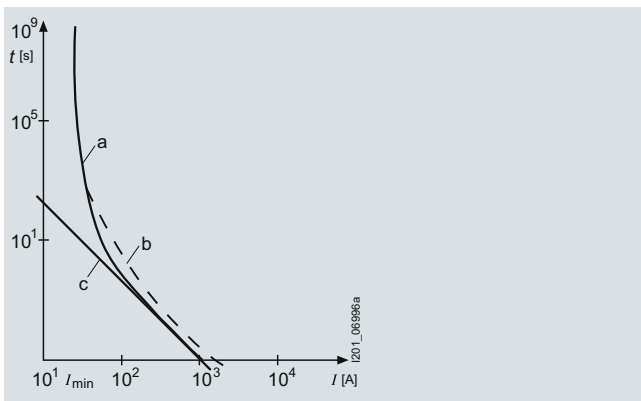

General representation of the time/current characteristic curve of a fuse link of gL/gG operational class

- I_{min} : Smallest melting current
- a: Melting time/current characteristic
- b: OFF time characteristic curve
- c: I^2t line

The shape of the characteristic curve depends on the outward heat transfer from the fuse element. DIN VDE 0636 specifies tolerance-dependent time/current ranges within which the characteristic curves of the fuse must lie. Deviations of $\pm 10\%$ are permissible in the direction of the current axis. With Siemens LV HRC fuse links of gG operational class, the deviations work out at less than $\pm 5\%$, a mark of our outstanding production accuracy. For currents up to approx. $20 I_n$, the melting time-current characteristic curves are the same as the OFF-time characteristic curves. In the case of higher short-circuit currents, the two characteristic curves move apart, influenced by the respective arc quenching time.

The difference between both lines (= arc quenching time) also depends on the power factor, the operational voltage and the breaking current.

The Siemens characteristic curves show the mean virtual melting time characteristic curves recorded at an ambient temperature of $(20 \pm 5)^\circ\text{C}$. They do not apply to preloaded fuse links.

Virtual time t_v

The virtual time is the time span calculated when a I^2t value is divided by the square of the prospective current:

$$t_v = \frac{\int I^2 dt}{I_p^2}$$

The time/current characteristic curve specifies the prospective current I_p and the virtual melting time t_{vs} .

Prospective short-circuit current I_p

The prospective short-circuit current is the r.m.s. value of the line-frequency AC component, or the value of the direct current to be expected in the event of a short-circuit occurring after the fuse, were the fuse to be replaced by a component of negligible impedance.

Let-through current characteristic curves

The let-through current characteristic curve specifies the value of the let-through current at 50 Hz as a function of the prospective current.

The let-through current I_c is the maximum instantaneous value of the current reached during a switching operation of the fuse.

The fuse element of the fuse links melts so quickly at very high currents that the surge short-circuit current I_p is prevented from occurring. The highest instantaneous value of the current reached during the shutdown cycle is called the let-through current I_c . The current limitations are specified in the current limiting diagrams, otherwise known as let-through current diagrams.

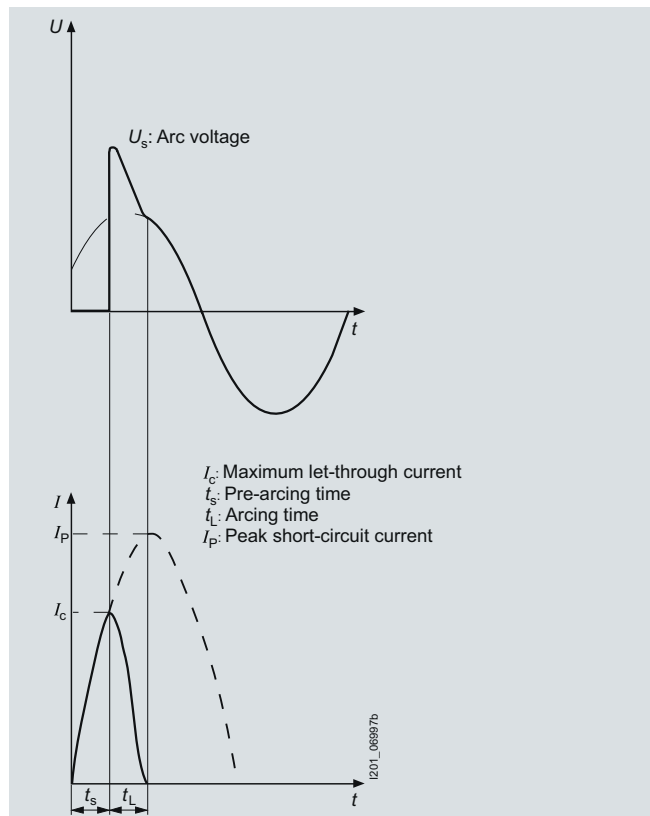

Oscillograph of a short-circuit current shutdown through a fuse link

Introduction

Current limitation

As well as a failsafe rated breaking capacity, the current-limiting effect of a fuse link is of key importance for the cost effectiveness of a system. In the event of short-circuit breaking by a fuse, the breaking current continues to flow through the network until the fuse link is switched off. However, the breaking current is limited by the system impedance.

The simultaneous melting of all the bottlenecks of a fuse element produce a sequence of tiny partial arcs that ensure a fast breaking operation with strong current limiting. The current limitation is also strongly influenced by the production quality of the fuse - which in the case of Siemens fuses is extremely high. For example, an LV HRC fuse link, size 2 (224 A) limits a breaking current with a possible r.m.s. value of approximately 50 kA to a let-through current with a peak value of approx. 18 kA. This strong current limitation provides constant protection for the system against excessive loads.

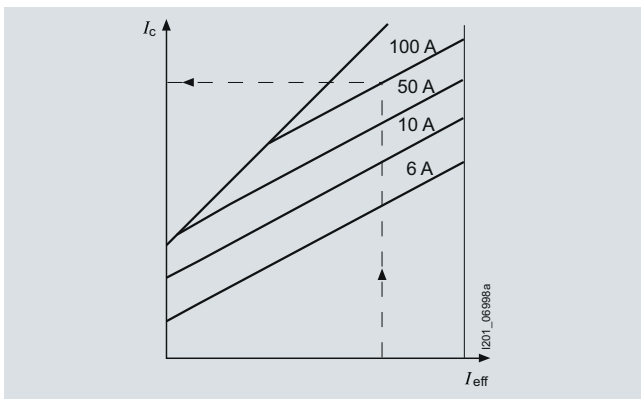

Current limitation diagram;
let-through current diagram of LV HRC fuse links, size 00,
operational class gL/gG,
rated currents, 6 A, 10 A, 50 A, 100 A

Legend

- t_{VS} = Virtual melting time
- I_C = Max. let-through current
- I_{eff} = R.m.s. value of the prospective short-circuit current
- I^2t_s = Melting I^2t value
- I^2t_a = Breaking I^2t value
- I_n = Rated current
- P_v = Rated power dissipation
- $\Delta\theta$ = Temperature rise
- k_A = Correction factor for I^2t value
- U_w = Recovery voltage
- \hat{U}_s = Peak arc voltage
- i_p = Peak short-circuit current
- ① = Peak short-circuit current with largest DC component
- ② = Peak short-circuit current without DC component
- U = Voltage
- i = current
- t_s = Melting time
- t_L = Arc quenching time

Rated power dissipation

Rated power dissipation is the power loss during the load of a fuse link with its rated current under prescribed conditions.

The cost effectiveness of a fuse depends largely on the rated power dissipation (power loss). This should be as low as possible and have low self-heating. However, when assessing the power loss of a fuse, it must also be taken into account that there is a physical dependence between the rated breaking capacity and the rated power dissipation. On the one hand, fuse elements need to be thick in order to achieve the lowest possible resistance value, on the other, a high rated breaking capacity requires the thinnest possible fuse elements in order to achieve reliable arc quenching.

Siemens fuses have the lowest possible rated power dissipation while also providing the highest possible load breaking reliability.

These values lie far below the limit values specified in the regulations. This means low temperature rises, reliable breaking capacity and high cost effectiveness.

I^2t value

The I^2t value (joule integral) is the integral of the current squared over a specific time interval:

$$I^2t = \int_{t_0}^{t_1} i^2 dt$$

Specifies the I^2t values for the melting process (I^2t_s) and for the shutdown cycle (I^2t_a , - sum of melting and quenching I^2t value). The melting I^2t value, also known as the total I^2t value or breaking I^2t value, is particularly important when dimensioning SITOR fuses for semiconductor protection. This value depends on the voltage and is specified with the rated voltage.

Peak arc voltage \hat{U}_s

The peak arc voltage is the highest value of the voltage that occurs at the contacts of the fuse link during the arc quenching time.

Residual value factor RW

The residual value factor is a reduction factor for determining the permissible load period of the fuse link with currents that exceed the permissible load current I_n' (see rated current I_n). This factor is applied when dimensioning SITOR fuses for semiconductor protection.

Varying load factor WL

The varying load factor is a reduction factor for the rated current with varying load states. This factor is applied when dimensioning SITOR fuses for semiconductor protection.

Recovery voltage U_w

The recovery voltage (r.m.s. value) is the voltage that occurs at the contacts of a fuse link after the power is cut off.

Overview

The NEOZED fuse system is primarily used in distribution technology and industrial switchgear assemblies. The system is easy to use and is also approved for domestic installation.

The MINIZED switch disconnectors are primarily used in switchgear assemblies and control engineering. They are approved for switching loads as well as for safe switching in the event of short circuits. The MINIZED D02 is also suitable for use in the precoupler sector in household applications in compliance with the recommendations of the VDEW according to TAB 2007.

Due to its small footprint, the MINIZED D01 fuse switch disconnector is primarily used in control engineering.

The NEOZED fuse bases are the most cost-effective solution for the application of NEOZED fuses. All NEOZED bases must be fed from the bottom to ensure that the threaded ring is insulated during removal of the fuse link. The terminals of the NEOZED bases are available in different versions and designs to support the various installation methods.

Fuse Systems

NEOZED fuse systems

NEOZED fuse links, 5SE2

Technical specifications

		NEOZED fuse links 5SE2																	
Standards		IEC 60269-3; DIN VDE 0636-3																	
Operational class		gG																	
Rated voltage U_n		V AC	400																
		V DC	250																
Rated current I_n		A	2 ... 100																
Rated breaking capacity		kA AC	50																
		kA DC	8																
Non-interchangeability		Using adapter sleeves																	
Resistance to climate		°C up to 45 at 95 % rel. humidity																	
Ambient temperature		°C -5 ... +40, humidity 90 % at 20																	
		MINIZED switch disconnectors D02 5SG7 1	MINIZED fuse switch disconnectors D01 5SG7 6	Fuse bases, made of ceramic D01 5SG1 5 5SG5 5			D02 5SG1 6 5SG5 6	D03 5SG1 8	Comfort bases D01/02 5SG1 .01 5SG5 .01	Fuse bases 5SG1 .30 5SG1 .31 5SG5 .30									
Standards		DIN VDE 0638; DIN VDE 0660-107 IEC/EN 60947-3		IEC 60269-3; DIN VDE 0636-3															
Main switch characteristic EN 60204-1		Yes		--			--												
Insulation characteristic EN 60664-1		Yes		--			--												
Rated voltage U_n		V AC	230/400, 240/415			400													
• 1P		V DC	65			48													
• 2P in series		V DC	130			110													
Rated current I_n		A	63			16			16										
Rated insulation voltage		V AC	500			400			--										
Rated impulse withstand voltage		kV AC	6			2.5			--										
Overvoltage category		4			--			--											
Utilization category acc. to VDE 0638		A			63			16											
• AC-22		A			63			16											
Utilization category acc. to EN 60947-3		A			63			16											
• AC-22 B		A			35			--											
• AC-23 B		A			63			--											
• DC-22 B		A			63			--											
Sealable when switched on		Yes			Yes, with sealable screw caps														
Mounting position		Any, but preferably vertical																	
Reduction factor of I_n with 18 pole		0.9			--			--											
• Side-by-side mounting		0.87			--			--											
• On top of one another, with vertical standard mounting rail		--			--			--											
Degree of protection acc. to IEC 60529		IP20, with connected conductors																	
Terminals with touch protection acc. to BGV A3		Yes			No			Yes											
Ambient temperature		°C -5 ... +40, humidity 90 % at 20																	
Terminal versions		--			B			K, S		K/S	--	--							
Conductor cross-sections		mm ²			1.5 ... 35			1.5 ... 16		1.5 ... 4		1.5 ... 25		10 ... 50		0.75 ... 35		1.5 ... 35	
• Solid and stranded		mm ²			1.5 ... 35			1.5		1.5		10		--		--		--	
• Flexible, with end sleeve		mm ²			--			--		0.75 ... 25		--		--		--		--	
• Finely stranded, with end sleeve		Nm			4			1.2		1.2		2		3.5/2.5		2.5 ... 3		3	
Tightening torques		Nm			4			1.2		1.2		2		3.5/2.5		2.5 ... 3		3	

Dimensional drawings

SFG7 1.3 MINIZED switch disconnectors D02, with draw-out technology

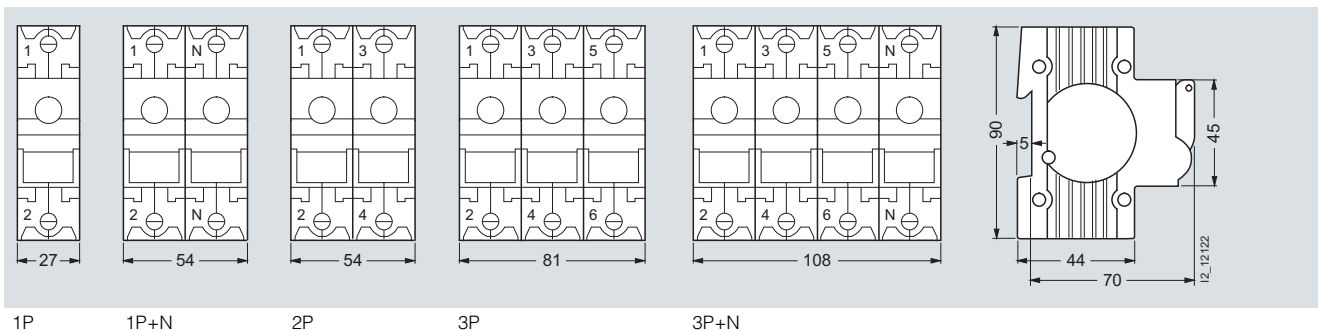

Locking cap for MINIZED switch disconnectors D02

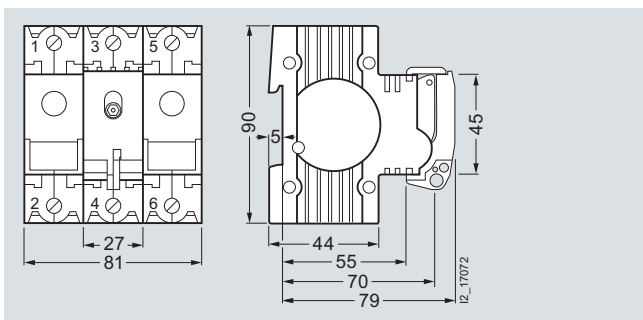

SFG7 6 MINIZED fuse switch disconnectors D01, with draw-out technology

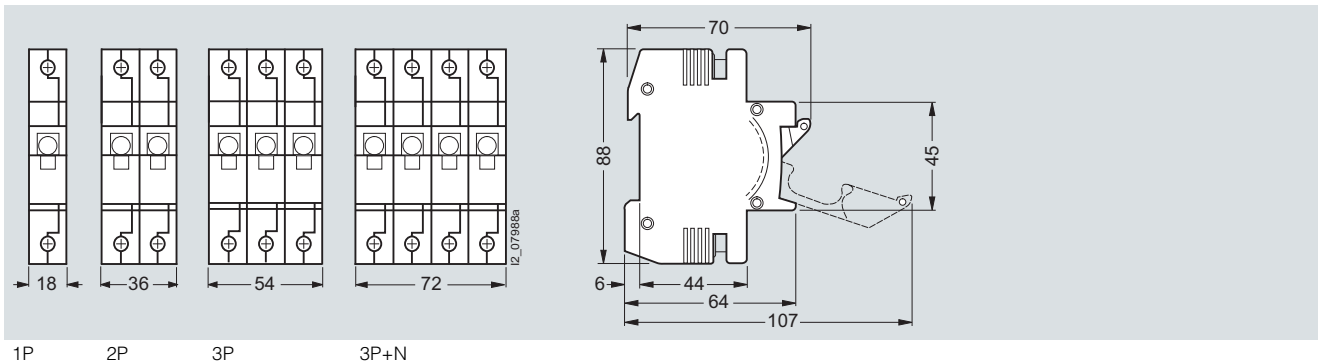

Fuse base with touch protection BGV A3 (VBG4), molded plastic

Sizes D01/D02, with combined terminal, can be busbar mounted

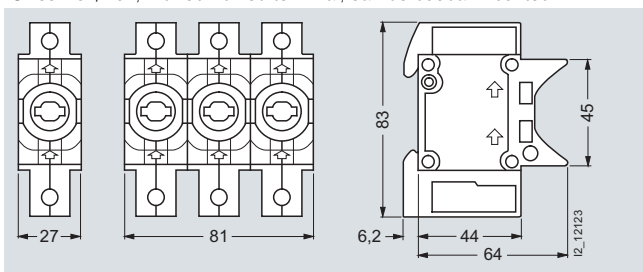

5SG1 301, 5SG5 301,
5SG1 701 5SG5 701

With cover

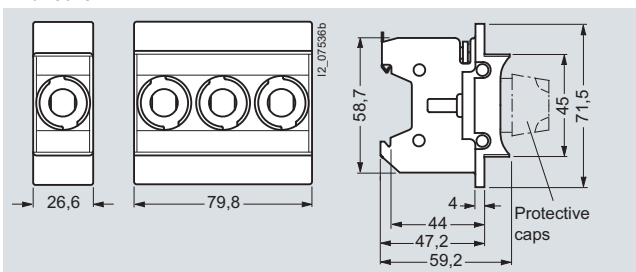

5SG1 330, 5SG5 330,
5SG1 331, 5SG5 730
5SG1 730,
5SG1 731

Fuse Systems

NEOZED fuse systems

NEOZED fuse links, 5SE2

NEOZED fuse bases made of ceramic

Sizes D01/D02/D03

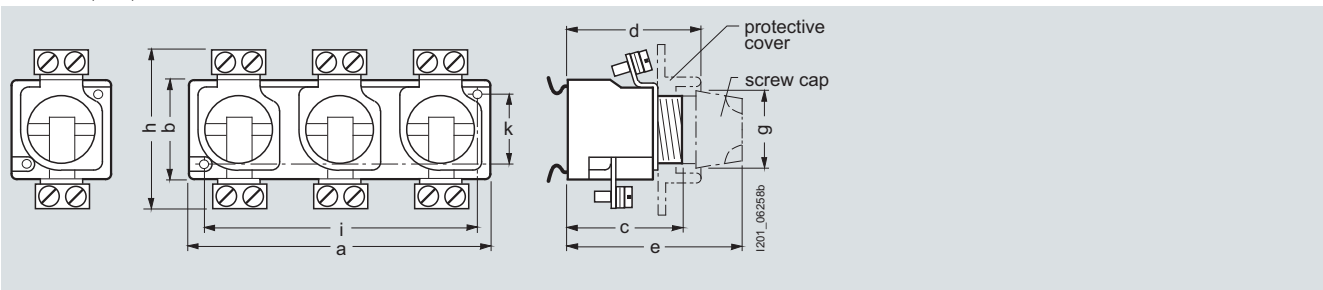

5SG1 5 5SG5 5

Type	Version	Size	Connection type	Dimensions									
				a	b	c	d	e	g not sealed/sealed	h	i	k	
Clip-on with cover													
5SG1 553	1-pole	D01	BB	26.8	36	40	56	70	23/26.5	54	--	--	
5SG1 653		D02	SS	26.8	36	41	56	70	23/26.5	59	--	--	
5SG1 693		D02	KS	26.8	36	41	56	70	23/26.5	60	--	--	
5SG5 553	3-pole	D01	BB	80.8	36	40	56	70	23/26.5	54	--	--	
5SG5 653		D02	SS	80.8	36	41	56	70	23/26.5	59	--	--	
5SG5 693		D02	KS	80.8	36	41	56	70	23/26.5	60	--	--	
Clip-on without cover													
5SG1 595	1-pole	D01	BB	26.8	36	40	56	70	23/26.5	54	--	--	
5SG1 655		D02	SS	26.8	36	41	56	70	23/26.5	59	--	--	
5SG1 695		D02	KS	26.8	36	41	56	70	23/26.5	60	--	--	
5SG1 812		D03	KS	44.9	50	44	54.5	76	44	86	--	--	
5SG5 555	3-pole	D01	BB	80.8	36	40	56	70	23/26.5	54	--	--	
5SG5 655		D02	SS	80.8	36	41	56	70	23/26.5	59	--	--	
5SG5 695		D02	KS	80.8	36	41	56	70	23/26.5	60	--	--	
Screw-on without cover													
5SG1 590	1-pole	D01	BB	26.8	36	40	56	70	23/26.5	54	20	22	
5SG1 650		D02	SS	26.8	36	41	56	70	23/26.5	59	20	22	
5SG1 810		D03	KS	44.9	50	46	54.5	76	44	86	32	32	
5SG5 550	3-pole	D01	BB	80.8	36	40	56	70	23/26.5	54	74	22	
5SG5 650		D02	SS	80.8	36	41	56	70	23/26.5	59	74	22	
5SG5 690		D02	KS	80.8	36	41	56	70	23/26.5	60	74	22	

Legend

Connection type:

- K = screw head contact
- B = clamp-type terminal
- S = saddle terminal

- BB = clamp-type terminal at incoming feeder
clamp-type terminal at outgoing feeder
- SS = saddle terminal at incoming feeder
saddle terminal at outgoing feeder
- KS = screw head contact at incoming feeder
saddle terminal at outgoing feeder

NEOZED covers made of molded plastic

NEOZED covers for NEOZED fuse bases, made of molded plastic

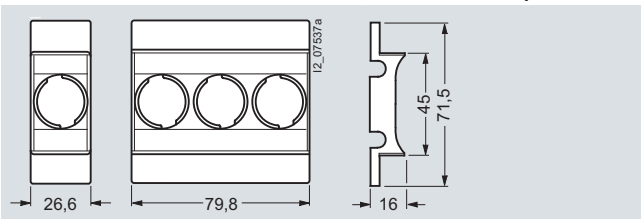

5SH5 244 (A1) 5SH5 245 (A2)

NEOZED covers for NEOZED fuse bases, made of ceramic

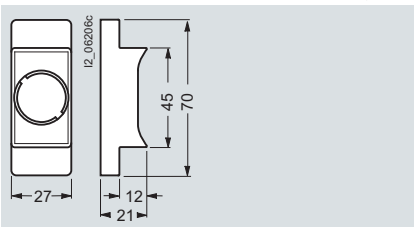

5SH5 251 (A4) and 5SH5 253 (A10)

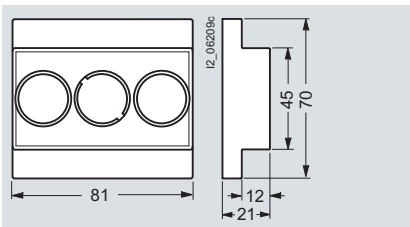

5SH5 252 (A5) and 5SH5 254 (A11)

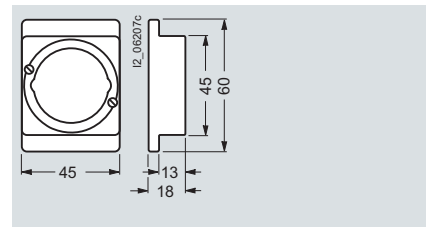

5SH5 233 (A6)

NEOZED screw caps

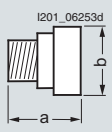
5SH4	Type	Size	Sealable	For mounting depth	Dimensions	
					a	b
	5SH4 116	D01	--	70	27.5	24
	5SH4 163	D02	--	70	27.5	24
	5SH4 316	D01	x	70	33	26.5
	5SH4 363	D02	x	76	33	26.5
	5SH4 100	D03	--	70	37	44
	5SH4 317	D01	--	70	29.5	25
	5SH4 362	D02	--	70	30.5	25

NEOZED fuse links

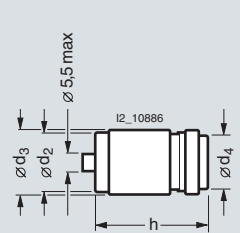
	Size/thread	Rated current in A	Dimension d _{2 min}	Dimension d ₃	Dimension d _{4 max}	Dimension h
	D01/E14	2 ... 16	9.8	11	6	36
D02/E18	20 ... 63	13.8	15.3	10	36	
D03/M30	80 ... 100	20.8	22.5	36	43	

Schematics

Diagrams

5SG7 1.3 MINIZED switch disconnectors D02, with draw-out technology

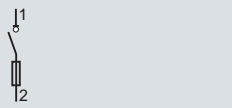
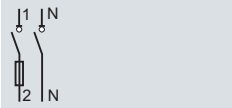
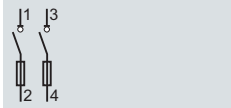
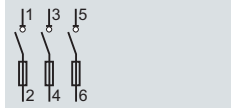
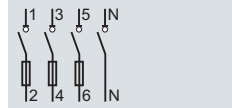
				
5SG7 113	5SG7 153	5SG7 123	5SG7 133 5SG7 133-8BA25 5SG7 133-8BA35 5SG7 133-8BA50	5SG7 163
1P	1P+N	2P	3P	3P+N

5SG7 6 MINIZED fuse switch disconnectors D01, with draw-out technology

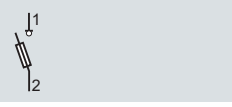
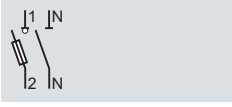
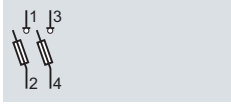
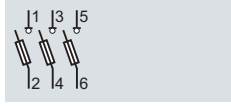
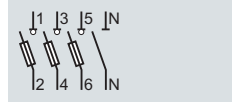
				
5SG7 610	5SG7 650	5SG7 620	5SG7 630	5SG7 660
1P	1P+N	2P	3P	3P+N

NEOZED fuse bases/general fuses

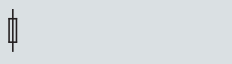
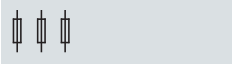
	
5SG1 1P	5SG5 3P

Fuse Systems

NEOZED fuse systems

NEOZED fuse links, 5SE2

Characteristic curves

Series 5SE2

Sizes: D01, D02, D03
 Operational class: gG
 Rated voltage: 400 V AC/250 V DC
 Rated current: 2 ... 100 A

Time/current characteristics diagram

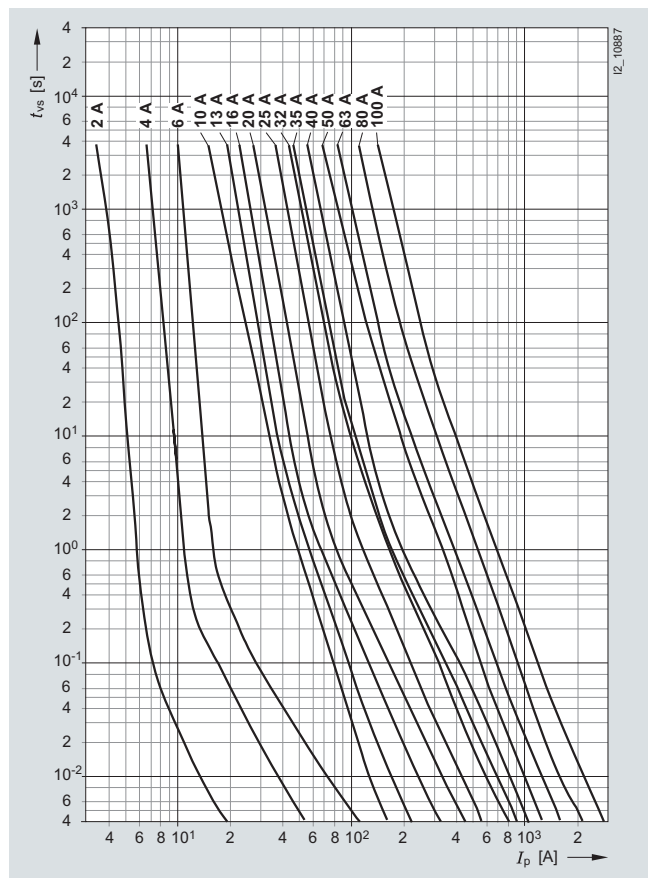

Melting I^2t values diagram

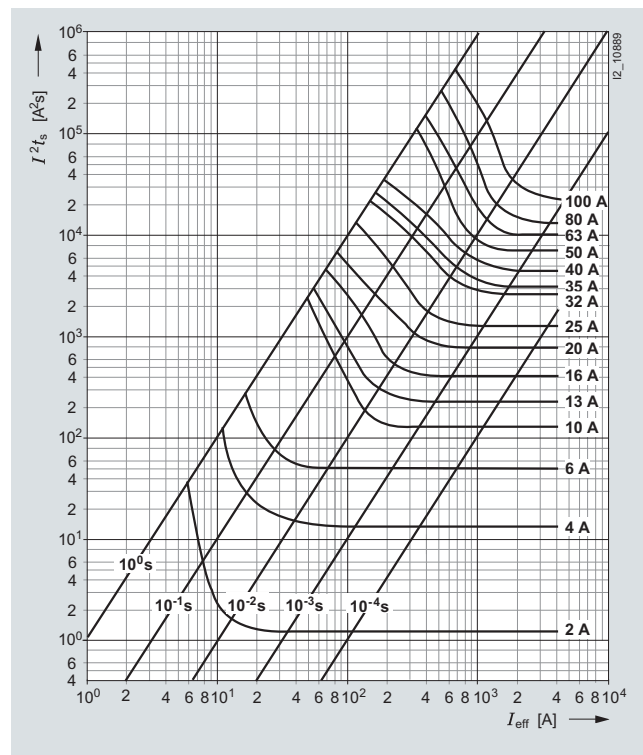
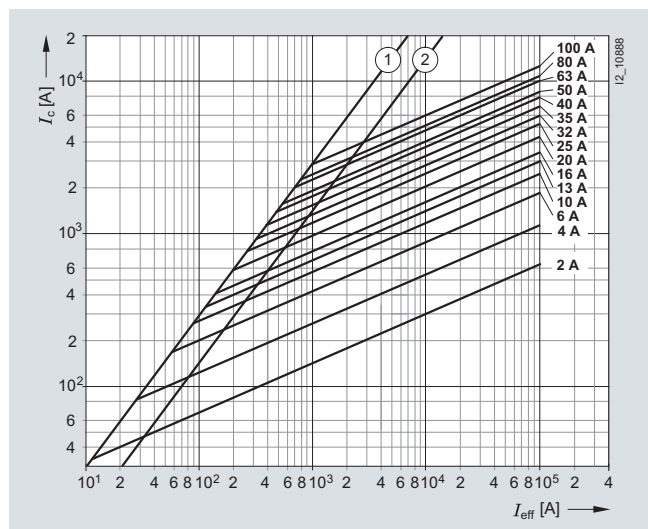

Table see page 15.

Current limitation diagram



- ① Peak short-circuit current with largest DC component
- ② Peak short-circuit current without DC component

Series 5SE2

Sizes: D01, D02, D03
 Operational class: gG
 Rated voltage: 400 V AC/250 V DC
 Rated current: 2 ... 100 A

Type	I_n	P_v	$\Delta\theta$	I^2t_s		I^2t_a	
	A	W	K	1 ms A ² s	4 ms A ² s	230 V AC ($t \leq 4$ ms) A ² s	400 V AC A ² s
5SE2 302	2	1.6	19	1.2	1.4	2.9	3.9
5SE2 304	4	1.3	14	12.5	13.6	22	30
5SE2 306	6	1.7	19	46.7	48	58	75
5SE2 310	10	1.3	16	120	136	220	280
5SE2 013-2A	13	2.0	23	220	244	290	370
5SE2 316	16	2.1	24	375	410	675	890
5SE2 320	20	2.4	26	740	810	1250	1650
5SE2 325	25	3.2	33	1210	1300	1900	2600
5SE2 332	32	3.6	34	2560	2800	4300	5500
5SE2 335	35	3.8	36	3060	3500	5100	6500
5SE2 340	40	4.0	37	4320	4800	7900	9500
5SE2 350	50	4.2	38	6750	7400	10500	13000
5SE2 363	63	5.3	45	10000	10900	16000	20500
5SE2 280	80	5.3	43	13000	15400	25000	34500
5SE2 300	100	6.4	47	22100	30000	46000	60000

Fuse Systems

DIAZED fuse systems, 5SA, 5SB, 5SC, 5SD

Overview

The DIAZED fuse system is one of the oldest fuse systems in the world. It was developed by Siemens as far back as 1906. It is still the standard fuse system in many countries to this day. It is particularly widely used in the harsh environments of industrial applications.

The series is available with rated voltages from 500 A to 750 V.

All DIAZED bases must be fed from the bottom to ensure an insulated threaded ring when the fuse link is being removed. Reliable contact of the fuse links is only ensured when used together with DIAZED screw adapters.

The terminals of the DIAZED bases are available in different versions and designs to support the various installation methods.

The high-performing EZR bus-mounting system for screw fixing is an outstanding feature. The busbars, which are particularly suited for bus-mounting bases, have a load capacity of up to 150 A with lateral infeed.

DIAZED stands for **D**iametral gestuftes **z**weiteiliges Sicherungssystem mit **E**disongewinde (diametral two-step fuse system with Edison screw).

Benefits

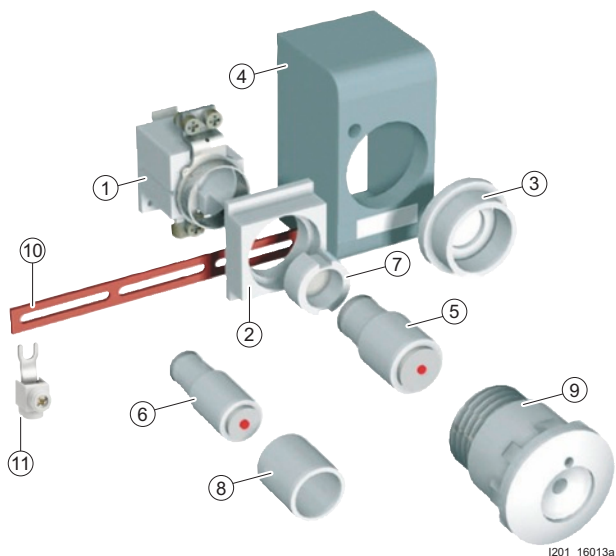

DIAZED fuse systems are a result of a well-designed modular system which enables the components to be combined in any way to meet the various requirements and to facilitate different installation methods.

- ① DIAZED bases
- ② DIAZED covers
- ③ DIAZED cover rings
- ④ DIAZED caps
- ⑤ DIAZED fuse links, DII
- ⑥ DIAZED fuse links, NDz
- ⑦ DIAZED screw adapters
- ⑧ DIAZED adapter sleeves
- ⑨ DIAZED screw caps
- ⑩ Busbars, oblong hole, single-phase
- ⑪ Terminal, fork-type terminal, non-insulated

Technical specifications

		5SA, 5SB, 5SC, 5SD	
Standards		IEC 60269-3; DIN VDE 0635; DIN VDE 0636-3; CEE 16	
Operational class	Acc. to IEC 60269; DIN VDE 0636	gG	
Characteristic	Acc. to DIN VDE 0635	Slow and quick	
Rated voltage U_n	V AC	500, 690, 750	
	V DC	500, 600, 750	
Rated current I_n	A	2 ... 100	
Rated breaking capacity	kA AC	50, 40 at E16	
	kA DC	8, 1.6 at E16	
Mounting position		Any, but preferably vertical	
Non-interchangeability		Using screw adapter or adapter sleeves	
Degree of protection	Acc. to IEC 60529	IP20, with connected conductors	
Resistance to climate	°C	Up to 45, at 95 % rel. humidity	
Ambient temperature	°C	-5 ... +40, humidity 90 % at 20	

		Terminal version									
		B			K			S		R	
Size		DII	DIII	NDz	DII	DIII	DIII	DIV	DII	DIII	
Conductor cross-sections											
• Rigid, min.	mm ²	1.5	2.5	1.0	1.5	2.5	2.5	10	1.5	1.5	
• Rigid, max.	mm ²	10	25	6	10	25	25	50	35	35	
• Flexible, with end sleeve	mm ²	10	25	6	10	25	25	50	35	35	
Tightening torques											
• Screw M4	Nm	1.2							--		
• Screw M5	Nm	2.0							--		
• Screw M6	Nm	2.5							4		
• Screw M8	Nm	3.5							--		

Dimensional drawings

DIAZED fuse links

5SA1, 5SA2

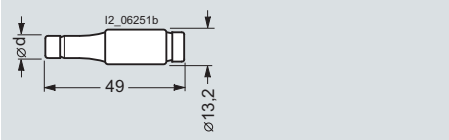

5SB1, 5SB2

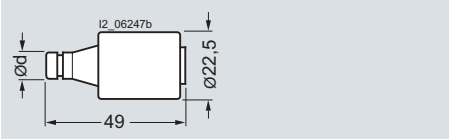

5SB3, 5SB4

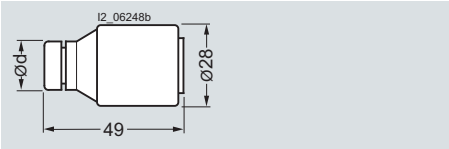

5SC1, 5SC2

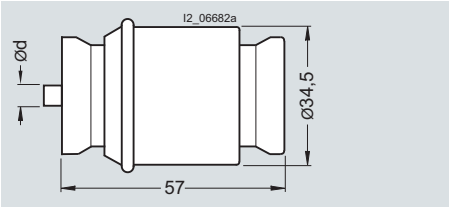

5SD6, 5SD8

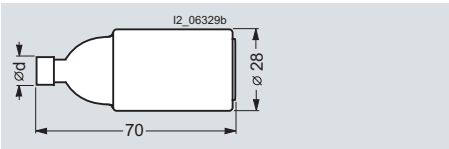

Size/thread	TNDz/E16, NDz/E16						
Rated current in A	2	4	6	10	16	20	25
Dimension d	6	6	6	8	10	12	14

Size/thread	DII/E27						
Rated current in A	2	4	6	10	16	20	25
Dimension d	6	6	6	8	10	12	14

Size/thread	DIII/E33			
Rated current in A	32	35	50	63
Dimension d	16	16	18	20

Size/thread	DIV/R1¼"	
Rated current in A	80	100
Dimension d	5	7

Size/thread	DIII/E33									
Rated current in A	2	4	6	10	16	20	25	35	50	63
Dimension d	6	6	6	8	10	12	14	16	18	20

Fuse Systems

DIAZED fuse systems, 5SA, 5SB, 5SC, 5SD

DIAZED fuse bases made of ceramic

5SF1

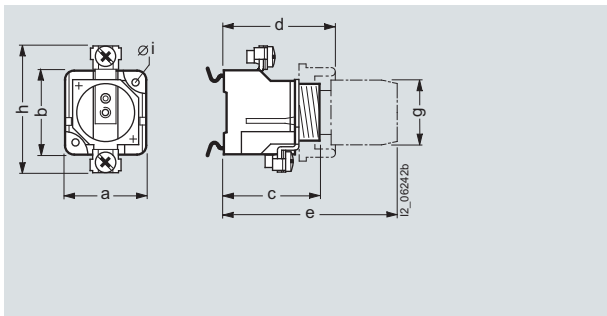

Version	Connection type	Dimensions							
		a	b	c	d	e	Øg	h	Øi
NDz/25 A									
5SF1 012	KK	29	49	44.6	55	75	32	49	--
5SF1 01	KK	29	49	44.6	55	75	32	49	4.2
DII/25 A									
5SF1 005	BB	38.4	41	46.6	53	83	34	63	--
5SF1 024	BB	38.4	41	46.6	53	83	34	63	4.3
DIII/63 A									
5SF1 205	BS	45.5	46	47	54	83	43	78	--
5SF1 215	SS	45.5	46	47	54	83	43	78	--
5SF1 224	BS	45.5	46	47	54	83	43	78	4.3
5SF1 214	SS	45.5	46	47	54	83	43	78	4.3
DIV/100 A									
5SF1 401	Flat terminal	68	68	--	79	110	65	116	6.5

5SF4 230

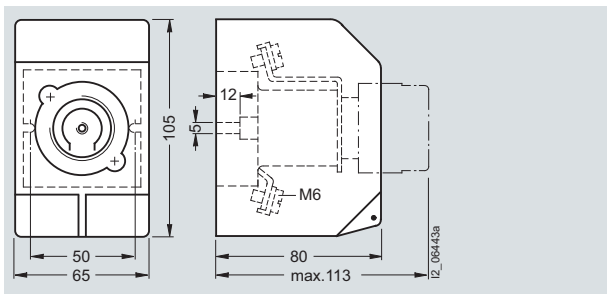

5SF5

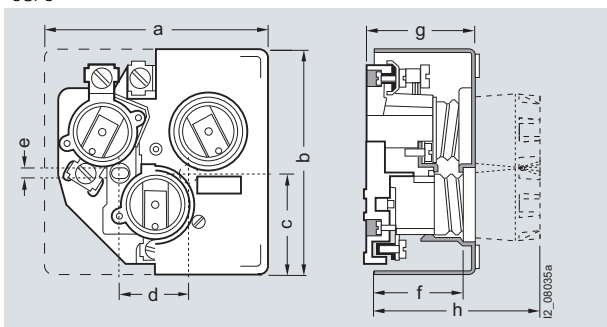

Version	Connection type	Dimensions							
		a	b	c	d	e	f	g	h
DII/3 × 25 A									
5SF5 067	BB	106	106	48	--	--	45	52	86
5SF5 066	KB	106	106	48	32	5.2	45	52	86
DIII/3 × 63 A									
5SF5 237	BB	127	130	54	--	--	45	52	85
5SF5 236	KB	127	130	54	32	5.2	45	52	85

DIAZED fuse bases made of molded plastic

5SF1, 5SF5

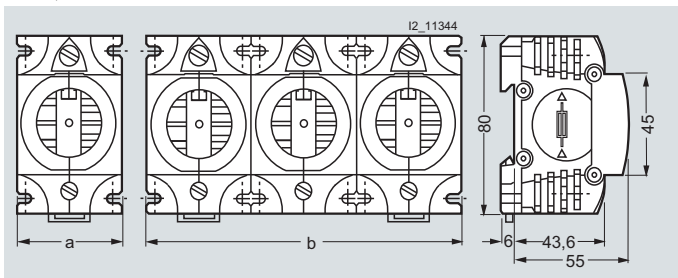

Type	Dimensions	
	a	b
5SF1 060	40	--
5SF1 260	50	--
5SF5 068	--	120
5SF5 268	--	150

DIAZED fuse systems, 5SA, 5SB, 5SC, 5SD

DIAZED EZR bus-mounting bases

5SF6 005

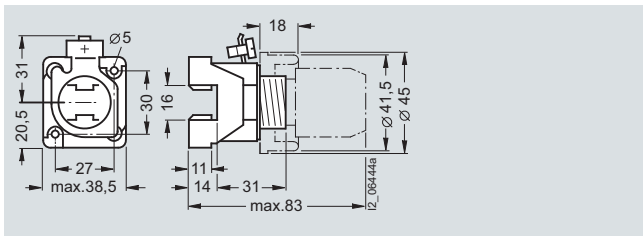

5SF6 205

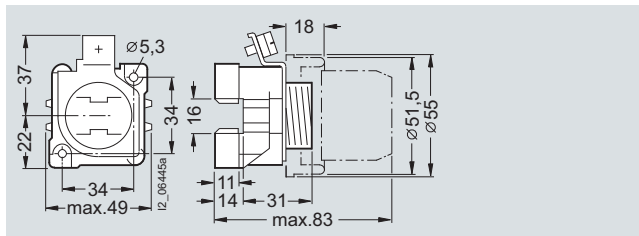

DIAZED screw caps/cover rings made of molded plastic/ceramic

Screw caps

5SH1

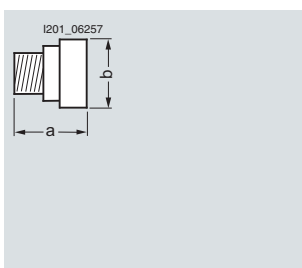

Cover rings

5SH3

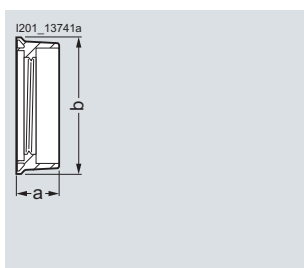

Size/thread	Screw caps			Cover rings		
	Type	Dimensions a	Øb	Type	a	Øb
NDz/E16	5SH1 112	36	24			
DII/E27	5SH1 221	42	33	5SH3 401	17.5	39.5
	5SH1 12	45.5	34	5SH3 32	17.5	41.5
	5SH1 22	43	39			
DIII/E33	5SH1 231	42	40	5SH3 411	17.5	49.5
	5SH1 13	45.5	43	5SH3 34	19	51.5
	5SH1 23	47	45			
	5SH1 161	48	48			
	5SH1 170	68	43			
DIV/R1¼"	5SH1 141	53	65			

DIAZED cover made of molded plastic

5SH2

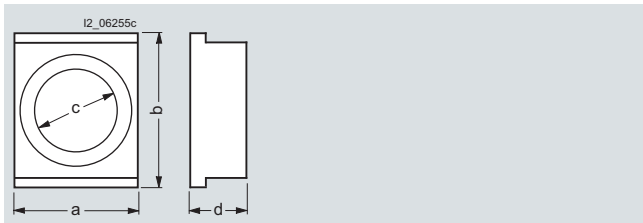

Size/thread	Type	Dimensions			
		a	b	Øc	d
DII/E27	5SH2 032	41	51	27.5	19
DIII/E33	5SH2 232	52	51	34.5	18.5

DIAZED caps made of molded plastic

5SH2

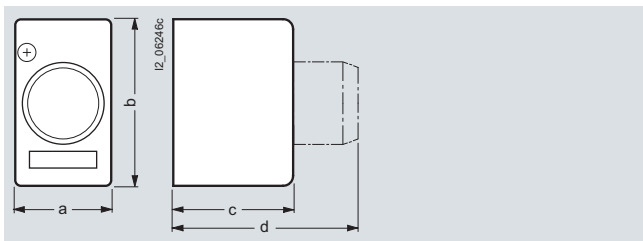

Size/thread	Type	Dimensions			
		a _{max}	b _{max}	c _{max}	d _{max}
NDz/E16	5SH2 01	33	68	51.7	75
DII/E27	5SH2 02	43	74.7	53.6	83
DIII/E33	5SH2 22	51	90.5	53.6	83

Fuse Systems

**DIAZED fuse systems,
5SA, 5SB, 5SC, 5SD**

Characteristic curves

Series 5SA2

Size: E16
 Characteristic: slow
 Rated voltage: 500 V AC/500 V DC
 Rated current: 2 ... 25 A

Time/current characteristics diagram

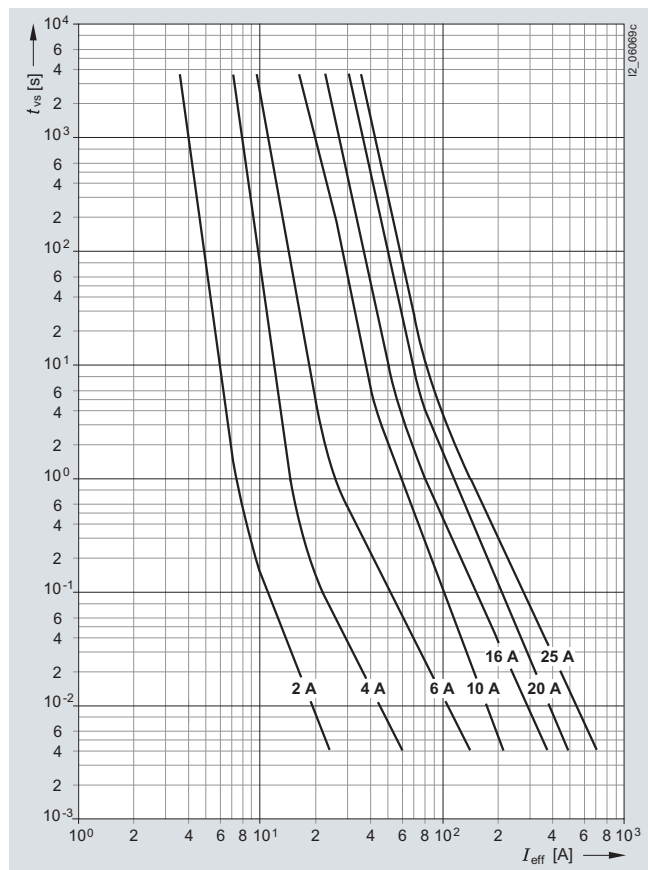

Melting I^2t values diagram

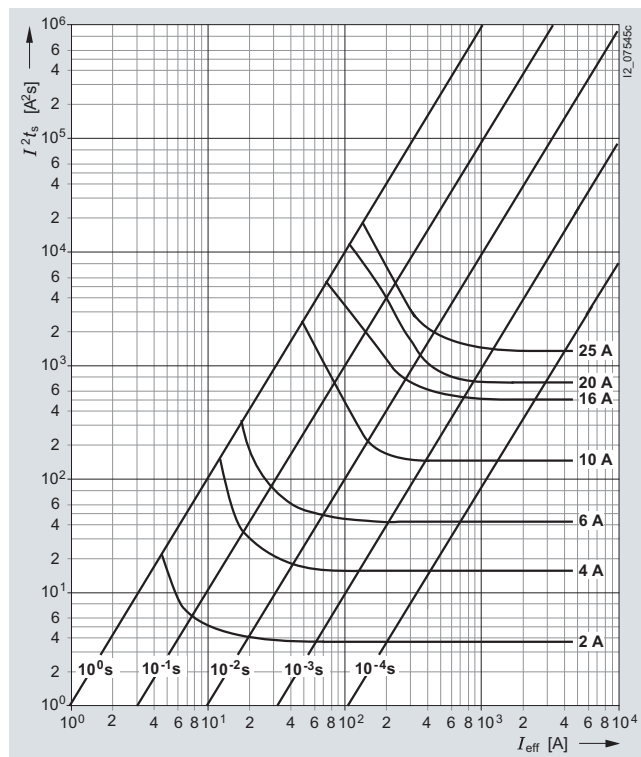

Current limitation diagram

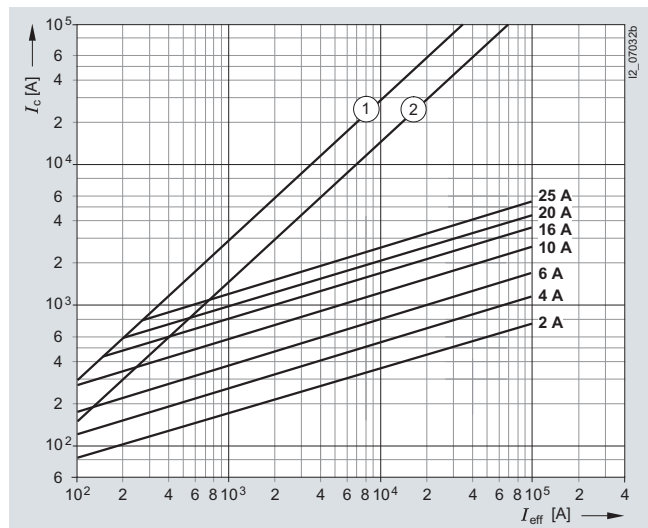

- ① Peak short-circuit current with largest DC component
- ② Peak short-circuit current without DC component

Type	I_n A	P_v W	$\Delta\theta$ K	I^2t_s 1 ms A ² s	4 ms A ² s
5SA2 11	2	0.85	15	1.2	2.3
5SA2 21	4	1.3	17	8.5	13
5SA2 31	6	1.9	14	40	80
5SA2 51	10	1.4	17	200	190
5SA2 61	16	2.4	30	290	550
5SA2 71	20	2.6	36	470	1990
5SA2 81	25	3.4	34	1000	2090

Type	I^2t_a 230 V AC A ² s	320 V AC A ² s	500 V AC A ² s
5SA2 11	6.6	7.8	0.7
5SA2 21	22	26	34
5SA2 31	66	76	100
5SA2 51	240	270	340
5SA2 61	890	950	1090
5SA2 71	1200	1350	1620
5SA2 81	2400	2600	3450

DIAZED fuse systems, 5SA, 5SB, 5SC, 5SD

Series 5SA1

Size: E16
 Characteristic: quick
 Rated voltage: 500 V AC/500 V DC
 Rated current: 2 ... 25 A

Time/current characteristics diagram

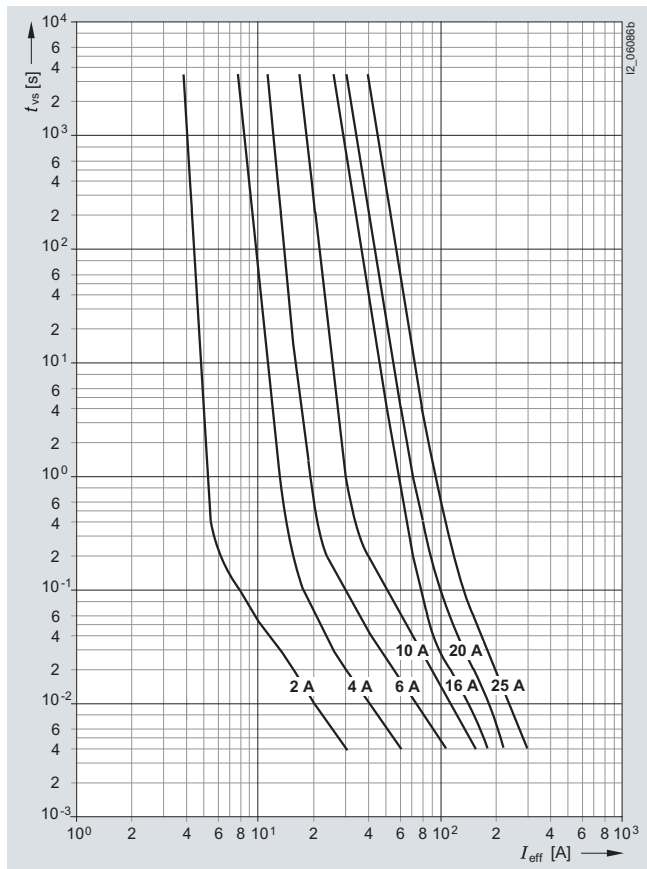

Melting I²t values diagram

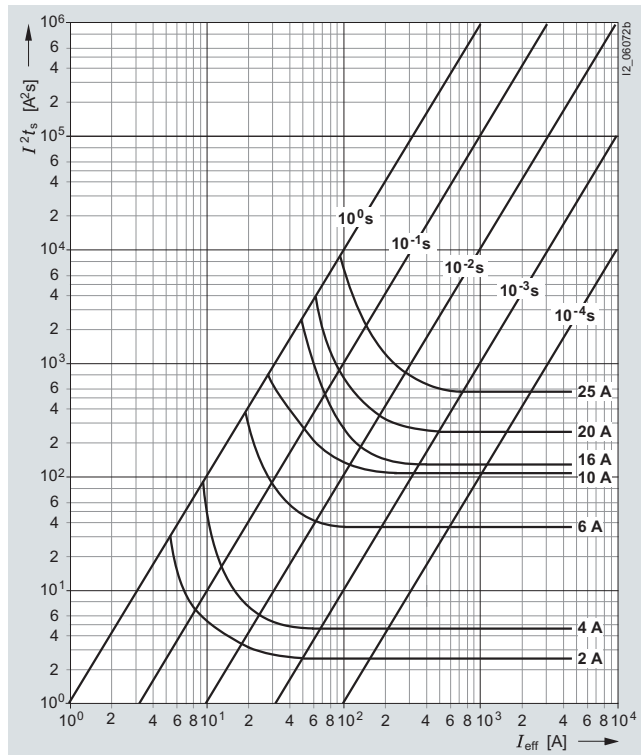

Current limitation diagram

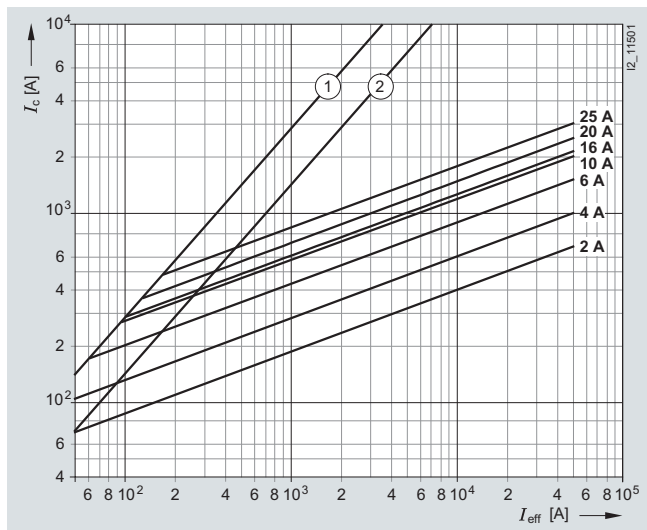

- ① Peak short-circuit current with largest DC component
- ② Peak short-circuit current without DC component

Type	I_n A	P_V W
5SA1 11	2	1.5
5SA1 21	4	1.9
5SA1 31	6	2.7
5SA1 51	10	3.4
5SA1 61	16	3.7
5SA1 71	20	4.4
5SA1 81	25	4.9

Fuse Systems

DIAZED fuse systems, 5SA, 5SB, 5SC, 5SD

Series 5SB2, 5SB4, 5SC2

Size: DII, DIII, DIV
 Operational class: gG
 Rated voltage: 500 V AC/500 V DC
 Rated current: 2 ... 100 A

Time/current characteristics diagram

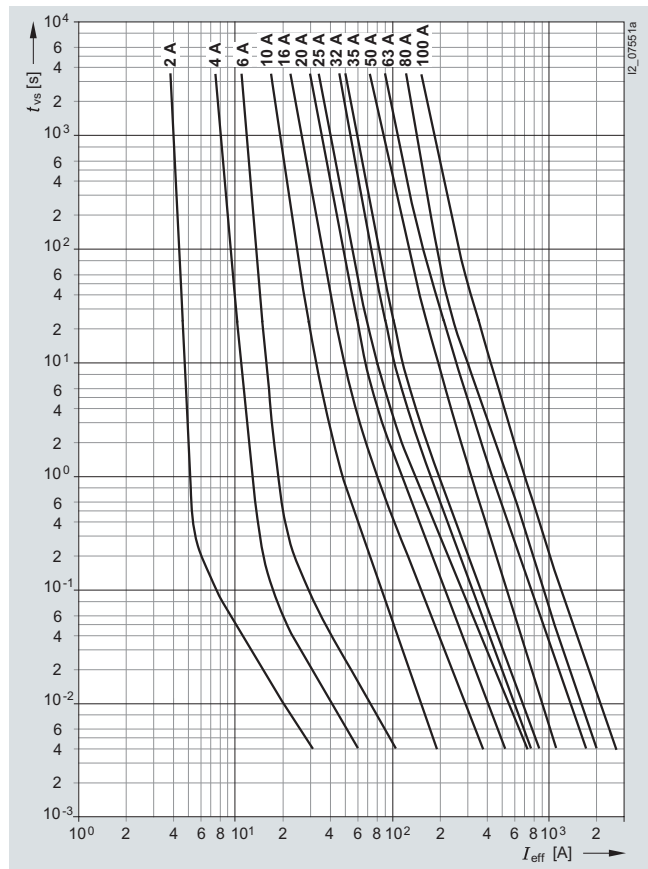

Melting I²t values diagram

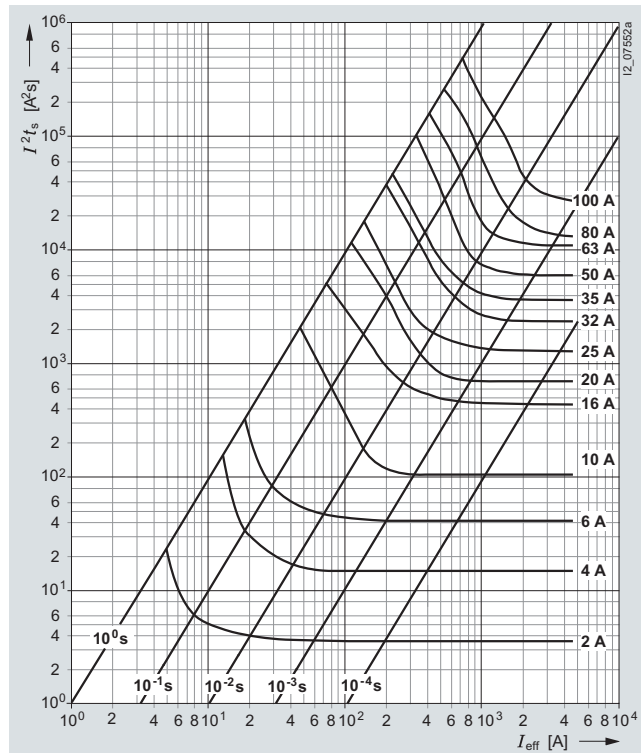

Current limitation diagram

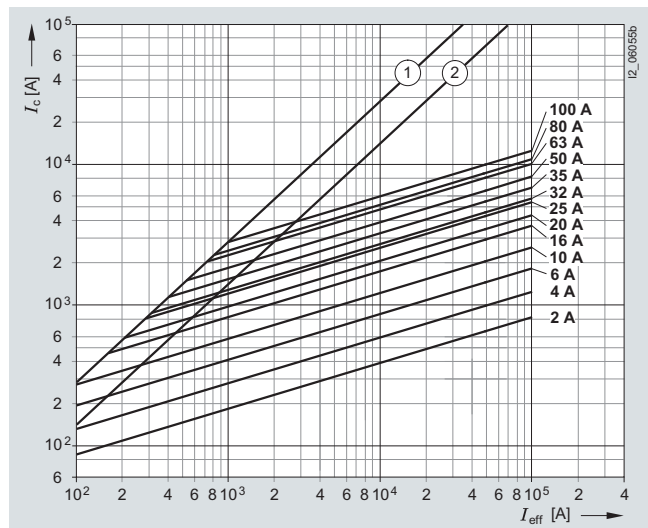

- ① Peak short-circuit current with largest DC component
- ② Peak short-circuit current without DC component

Type	I_n	P_V	$\Delta\theta$	I^2t_s	
	A	W	K	1 ms A ² s	4 ms A ² s
5SB2 11	2	2.6	15	3.7	3.9
5SB2 21	4	2.0	13	15	16
5SB2 31	6	2.2	14	42	45
5SB2 51	10	1.6	20	120	140
5SB2 61	16	2.4	23	500	580
5SB2 71	20	2.6	26	750	1100
5SB2 81	25	3.4	38	1600	2000
5SB4 010	32	3.6	23	2300	2500
5SB4 11	35	3.7	25	3450	3000
5SB4 21	50	5.7	41	6500	5200
5SB4 31	63	6.9	48	11000	12000
5SC2 11	80	7.5	33	14600	16400
5SC2 21	100	8.8	46	28600	30000

Type	I^2t_a		
	230 V AC A ² s	320 V AC A ² s	500 V AC A ² s
5SB2 11	6.6	8.8	10.7
5SB2 21	22	28	34
5SB2 31	66	85	100
5SB2 51	240	300	340
5SB2 61	890	1060	1090
5SB2 71	1200	1450	1620
5SB2 81	2400	3150	3450
5SB4 010	3450	4150	4850
5SB4 11	5200	6200	7200
5SB4 21	9750	12350	14500
5SB4 31	16500	22200	26500
5SC2 11	23000	28500	32500
5SC2 21	44000	56000	65000

Series 5SB1, 5SB3, 5SC1

Size: DII, DIII, DIV
Operational class: quick
Rated voltage: 500 V AC/500 V DC
Rated current: 2 ... 100 A

Time/current characteristics diagram

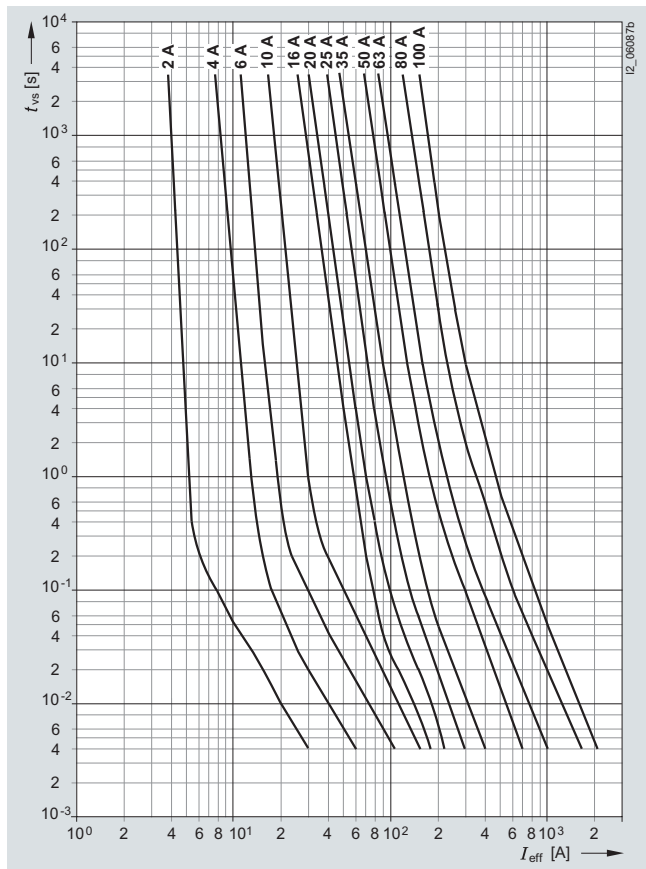

Melting I^2t values diagram

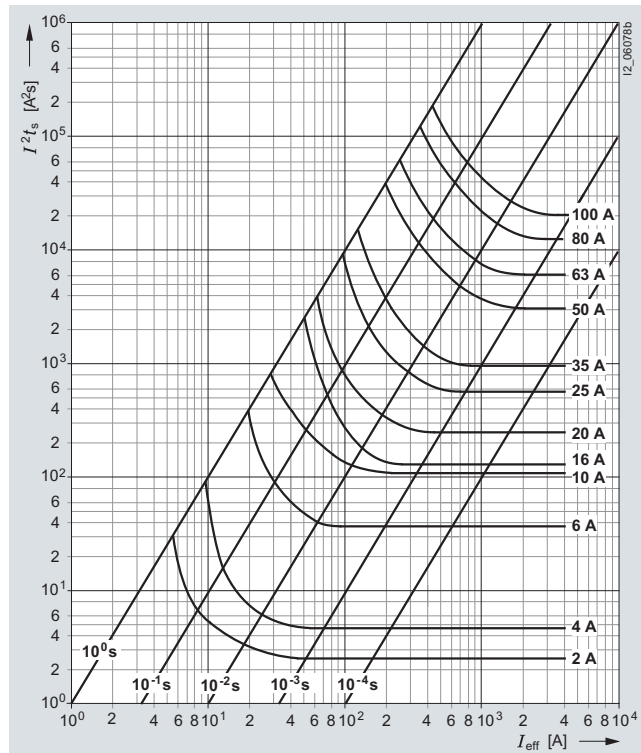

Current limitation diagram

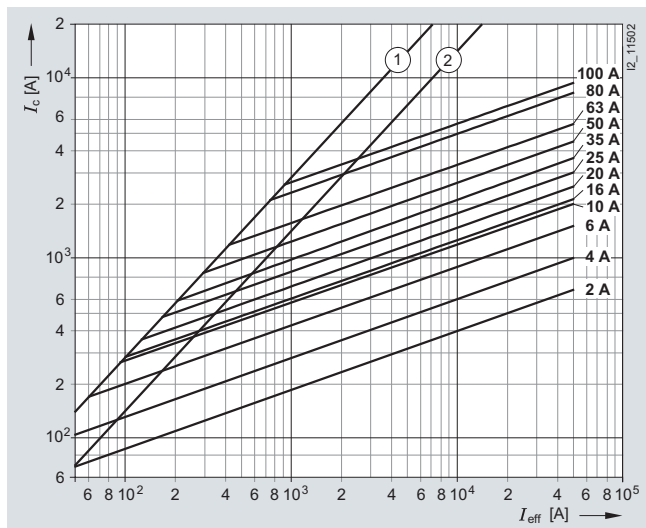

- ① Peak short-circuit current with largest DC component
- ② Peak short-circuit current without DC component

Type	I_n A	P_v W	$\Delta\theta$ K	I^2t_s 4 ms A ² s	I^2t_a 500 V AC A ² s
5SB1 11	2	1.5	3	2.5	5
5SB1 21	4	1.9	13	15.6	31.2
5SB1 31	6	2.7	18	36	72
5SB1 41, 5SB1 51	10	3.4	23	102	204
5SB1 61	16	3.7	24	130	260
5SB1 71	20	4.4	31	185	370
5SB1 81	25	4.9	34	250	500
5SB3 11	35	8.3	39	640	1280
5SB3 21	50	9.9	49	1960	3920
5SB3 31	63	12.8	63	3880	7760
5SC1 11	80	12.7	45	10890	21780
5SC1 21	100	15.4	55	17400	34800

Fuse Systems

DIAZED fuse systems, 5SA, 5SB, 5SC, 5SD

Series 5SD8

Size: DIII
 Operational class: gG
 Rated voltage: 690 V AC/600 V DC
 Rated current: 2 ... 63 A

Time/current characteristics diagram

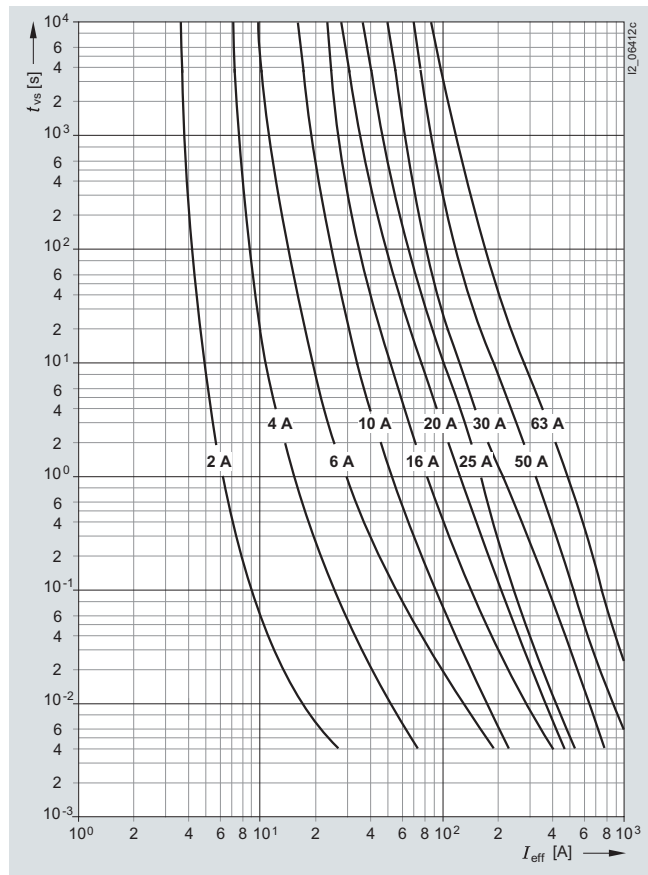

Melting I²t values diagram

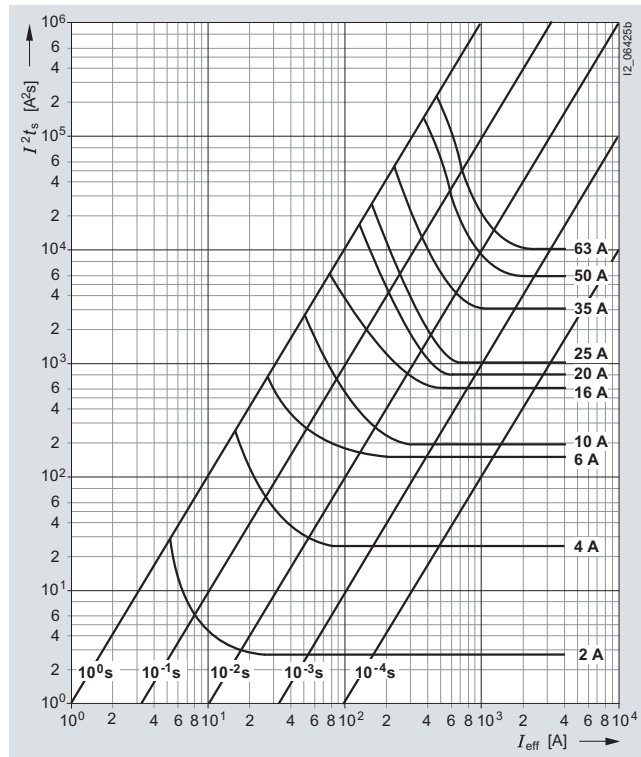

Current limitation diagram

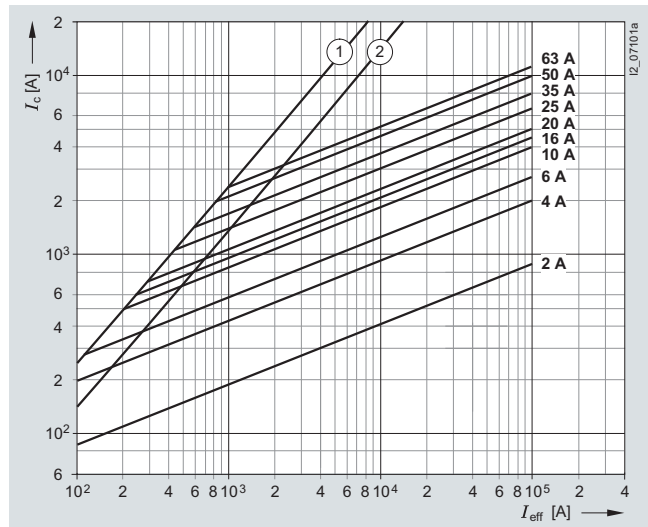

- ① Peak short-circuit current with largest DC component
- ② Peak short-circuit current without DC component

Type	I_n A	P_v W	$I^2 t_s$ 4 ms A ² s	$I^2 t_a$ 242 V AC A ² s
5SD8 002	2	1	4.4	7
5SD8 004	4	1.2	40	62
5SD8 006	6	1.6	88	140
5SD8 010	10	1.4	240	380
5SD8 016	16	1.8	380	600
5SD8 020	20	2	750	1200
5SD8 025	25	2.3	2000	3200
5SD8 035	35	3.1	3300	5100
5SD8 050	50	4.6	7000	11000
5SD8 063	63	5.5	9500	15000

DIAZED fuse systems, 5SA, 5SB, 5SC, 5SD

Series 5SD6

Size: DIII
 Operational class: quick (railway network protection)
 Rated voltage: 750 V AC/750 V DC
 Rated current: 2 ... 63 A

Time/current characteristics diagram

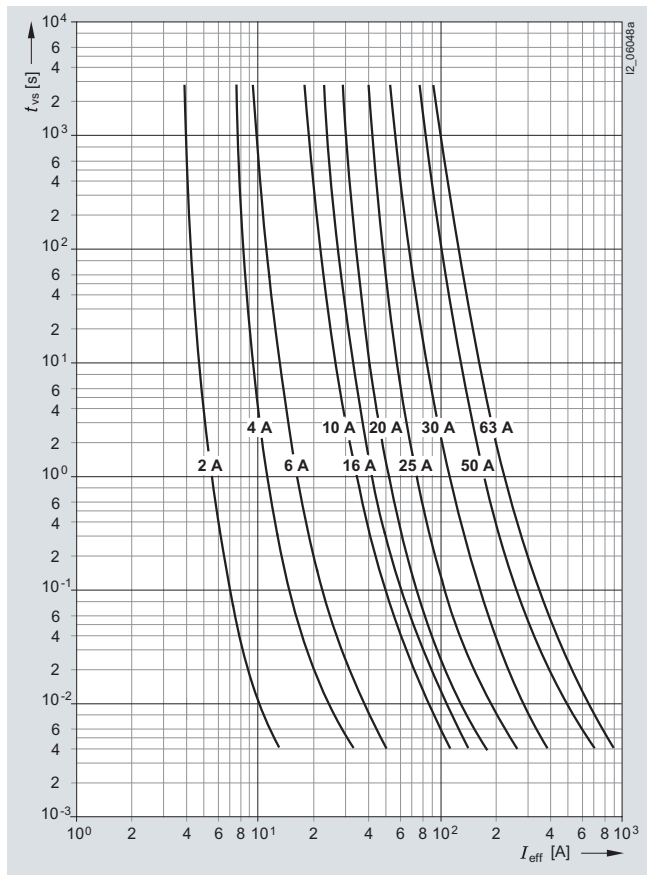

Melting I²t values diagram

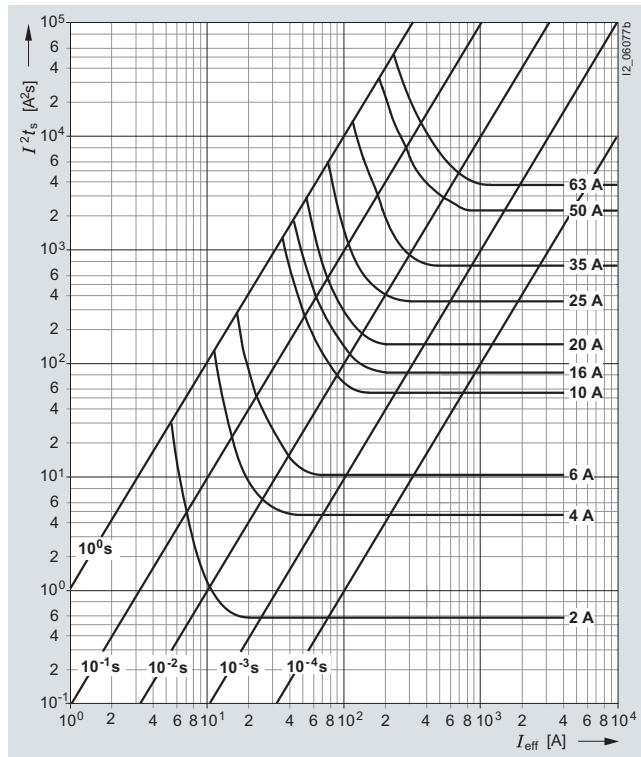

Current limitation diagram

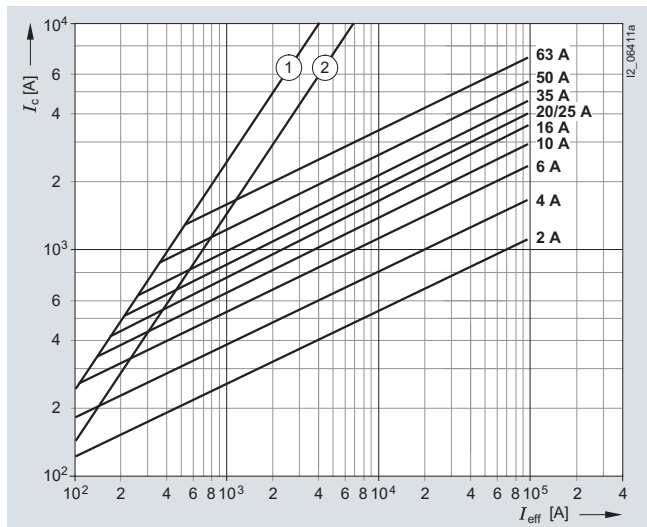

- ① Peak short-circuit current with largest DC component
- ② Peak short-circuit current without DC component

Type	I_n A	P_v W	I^2t_s 4 ms A ² s	I^2t_a 500 V AC A ² s
5SD6 01	2	2.8	0.7	2
5SD6 02	4	4	4.5	13
5SD6 03	6	4.8	10	29
5SD6 04	10	4.8	50	135
5SD6 05	16	5.9	78	220
5SD6 06	20	6.3	125	380
5SD6 07	25	8.3	265	800
5SD6 08	35	13	550	1600
5SD6 10	50	16.5	1800	5500
5SD6 11	63	18	3100	9600

Cylindrical fuse links and cylindrical fuse holders, 3NW6, 3NW7, 3NW8

Overview

Cylindrical fuses are standard in Europe. There are a range of different cylindrical fuse links and holders that comply with the standards IEC 60269-1, -2 and -3, and which are suitable for use in industrial applications. In South West Europe they are also approved for use in residential buildings.





The cylindrical fuse holders are also approved to UL 512. The cylindrical fuse holders are tested and approved as fuse disconnectors according to the switching device standard IEC 60947-3. They are not suitable for switching loads.

Cylindrical fuse holders can be supplied with or without signal detectors. In the case of devices with signal detector, a small electronic device with LED is located behind an inspection window in the plug-in module. If the inserted fuse link is tripped, this is indicated by the LED flashing.

The switching state of the fuse holder can be signaled over a side-mounted auxiliary switch, which enables the integration of the fuses in the automation process.

Technical specifications

		Cylindrical fuse links						
		3NW6 3..	3NW6 0..	3NW6 1..	3NW6 2..	3NW8 0..	3NW8 1..	3NW8 2..
Sizes	mm x mm	8 x 32	10 x 38	14 x 51	22 x 58	10 x 38	14 x 51	22 x 58
Standards		IEC 60269-1, -2, -3; NF C 60-200; NF C 63-210, -211; NBN C 63269-2, CEI 32-4, -12						
Operational class		gG					aM	
Rated voltages U_n	V AC	400 or 500						
Rated current I_n	A	2 ... 20	2 ... 32	4 ... 50	8 ... 100	0.5 ... 25	2 ... 50	10 ... 100
Rated breaking capacity								
• 500 V version	kA AC	100						
• 400 V version	kA AC	20						
Mounting position		Any, but preferably vertical						

		Cylindrical fuse holders			
		3NW7 3..	3NW7 0..	3NW7 1..	3NW7 2..
Sizes	mm x mm	8 x 32	10 x 38	14 x 51	22 x 58
Standards		IEC 60269-1, -2, -3; NF C 60-200; NF C 63-210, -211; NBN C 63269-2-1, CEI 32-4, -12			
Approvals	Acc. to UL Acc. to CSA	--			--
		--			--
Rated voltage U_n	V AC V AC Acc. to UL/CSA	400 400	690 600		
Rated current I_n	A AC	20	32	50	100
Rated breaking capacity	kA	20	100		
Switching capacity		AC-20B (switching without load), DC-20B			
• Utilization category					
No-voltage changing	of fuse links	Yes			
Sealable	when installed	Yes			
Mounting position		Any, but preferably vertical			
Degree of protection	Acc. to IEC 60529	IP20, with connected conductors			
Terminals with touch protection according to BGV A3 at incoming and outgoing feeder		Yes			
Ambient temperature	°C	-5 ... +40, humidity 90 % at +20			
Conductor cross-sections					
• Rigid	mm ²	0.5 ... 10		2.5 ... 10	4 ... 10
• Stranded	mm ²	0.5 ... 10		2.5 ... 25	4 ... 50
• Finely stranded, with end sleeve	mm ²	0.5 ... 10		2.5 ... 16	4 ... 35
• AWG (American Wire Gauge)		--	10 ... 20	6 ... 10	--
Tightening torques	Nm	1.2		2.0	2.5

Cylindrical fuse links and cylindrical fuse holders, 3NW6, 3NW7, 3NW8

Dimensional drawings

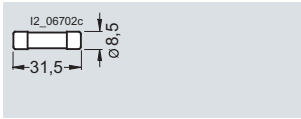

Sizes
8 × 32 mm

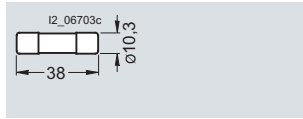

10 × 38 mm

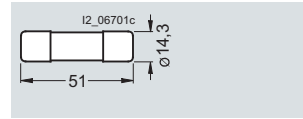

14 × 51 mm

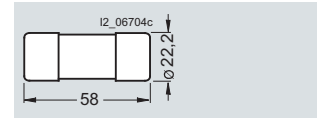

22 × 58 mm

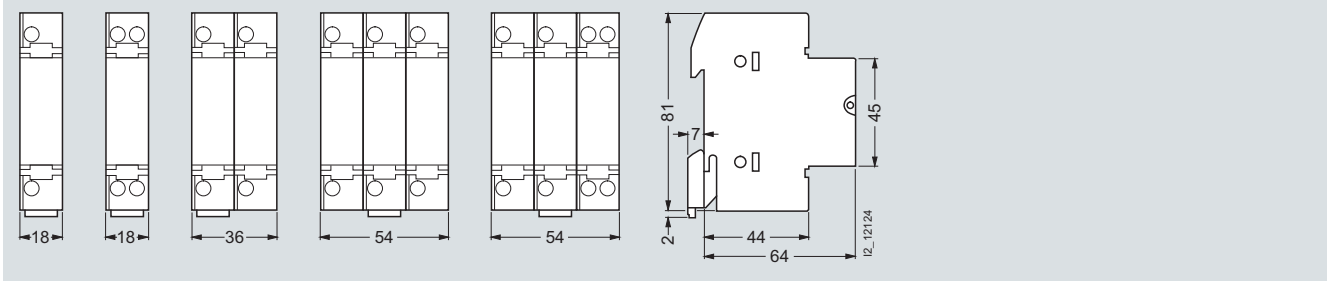

3NW7 0, 3NW7 3
1P 1P+N 2P 3P 3P+N

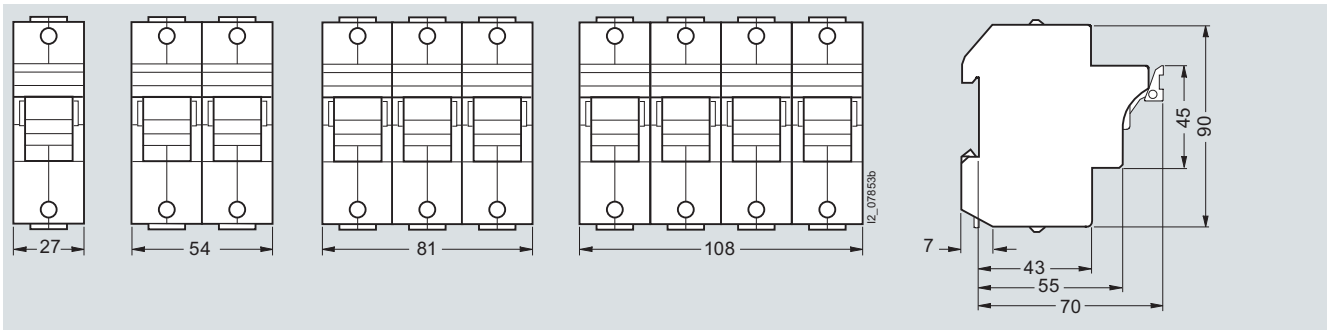

3NW7 1
1P 1P+N/2P 3P 3P+N

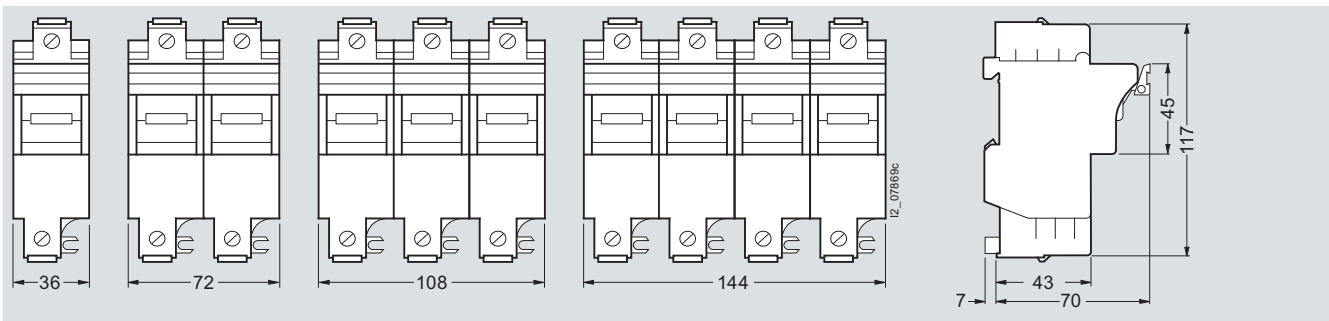

3NW7 2
1P 1P+N/2P 3P 3P+N

Auxiliary switches

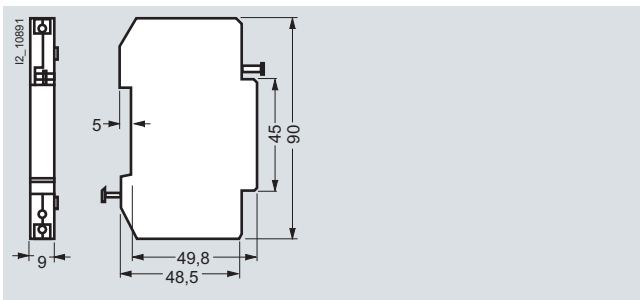

3NW7 901
3NW7 902

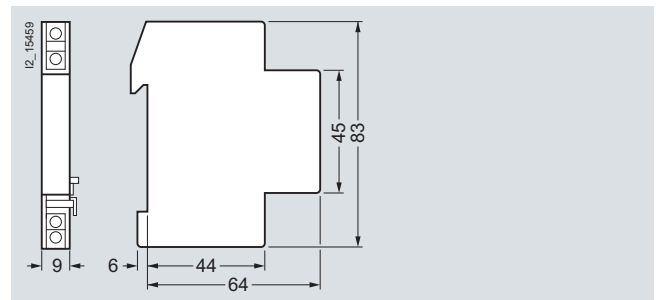

3NW7 903

Fuse Systems

Cylindrical fuse links and cylindrical fuse holders, 3NW6, 3NW7, 3NW8

Schematics

Diagrams

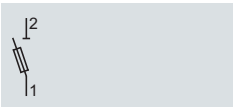

1P

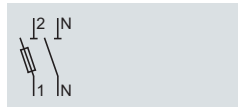

1P+N

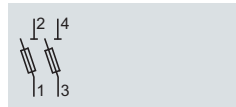

2P

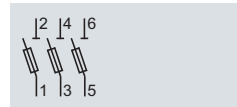

3P

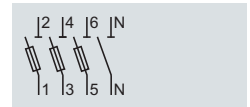

3P+N

Auxiliary switches

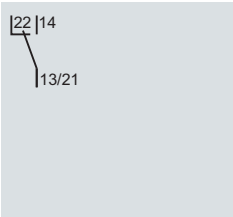
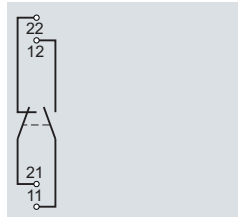
3NW7 901
3NW7 902

3NW7 903

Cylindrical fuse links and cylindrical fuse holders, 3NW6, 3NW7, 3NW8

Characteristic curves

Series 3NW6 0

Size: 10 mm × 38 mm
 Operational class: gG
 Rated voltage: 500 V AC (2 ... 25 A),
 400 V AC (32 A)
 Rated current: 2 ... 32 A

Time/current characteristics diagram

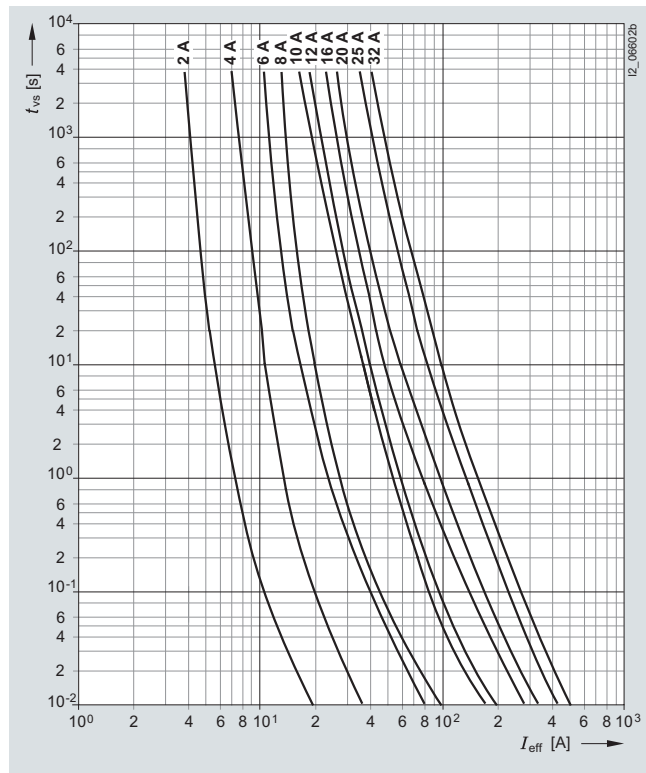

Current limitation diagram

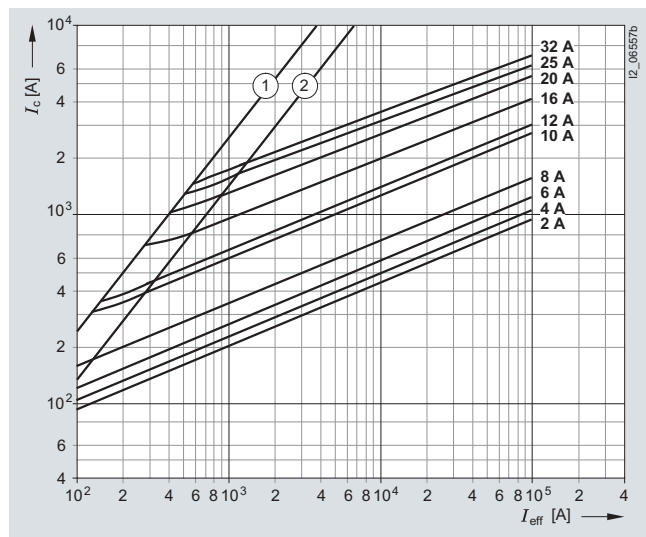

- ① Peak short-circuit current with largest DC component
- ② Peak short-circuit current without DC component

Melting I^2t values diagram

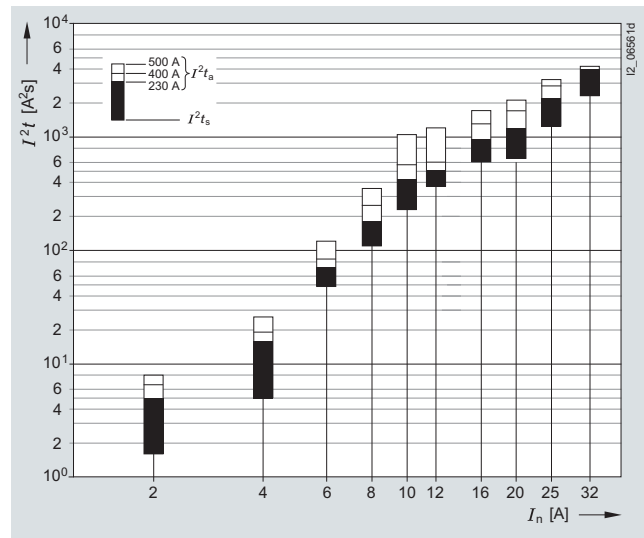

Type	I_n	P_v	$\Delta\theta$	I^2t_s	I^2t_a	400 V AC	500 V AC
	A	W	K	1 ms A ² s	230 V AC A ² s	A ² s	A ² s
3NW6 002-1	2	2.2	32	1.6	5	6.5	8
3NW6 004-1	4	1.2	16.5	5	16	19	26
3NW6 001-1	6	1.6	23	48	70	84	120
3NW6 008-1	8	2.3	35	110	180	140	350
3NW6 003-1	10	0.7	16	230	420	570	1050
3NW6 006-1	12	0.9	33	390	510	600	1200
3NW6 005-1	16	1.3	38	600	950	1300	1700
3NW6 007-1	20	2.1	51.5	640	1200	1700	2100
3NW6 010-1	25	2.1	54	1300	2200	2800	3200
3NW6 012-1	32	2.5	51	2360	4000	4200	--

Fuse Systems

Cylindrical fuse links and cylindrical fuse holders, 3NW6, 3NW7, 3NW8

Series 3NW6 1

Size: 14 mm × 51 mm
 Operational class: gG
 Rated voltage: 500 V AC (4 ... 40 A),
 400 V AC (50 A)
 Rated current: 4 ... 50 A

Time/current characteristics diagram

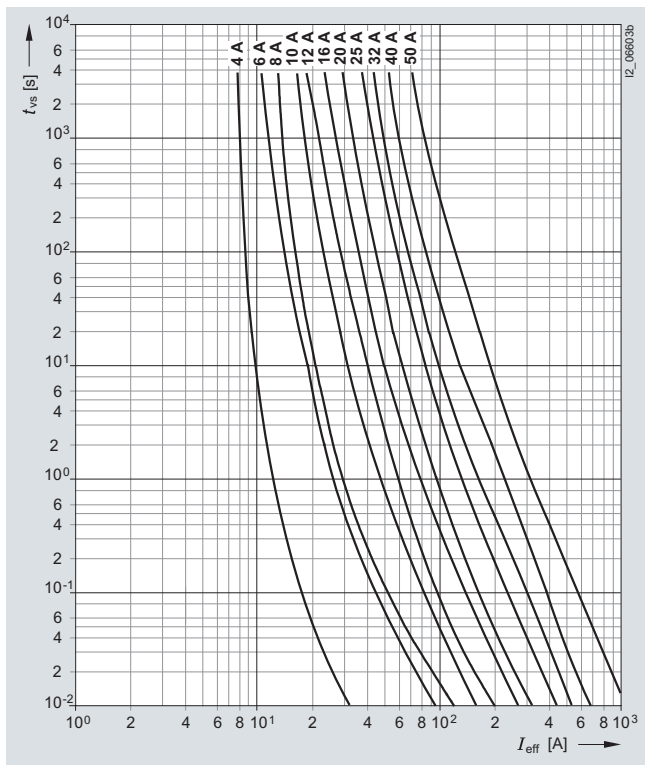

Current limitation diagram

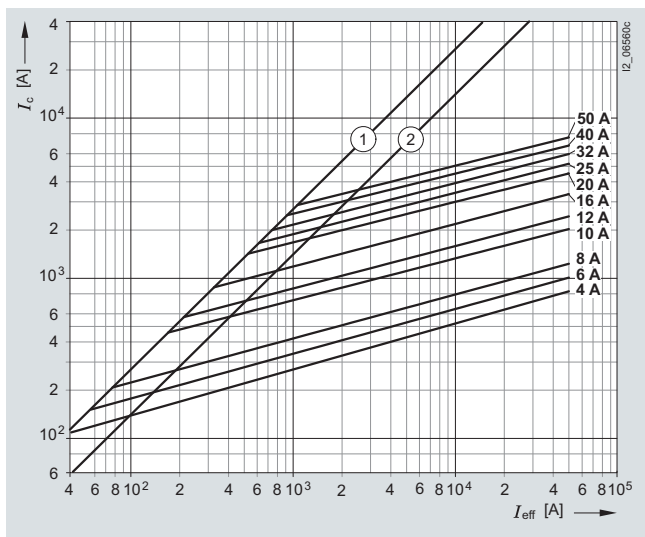

- ① Peak short-circuit current with largest DC component
- ② Peak short-circuit current without DC component

Melting I^2t values diagram

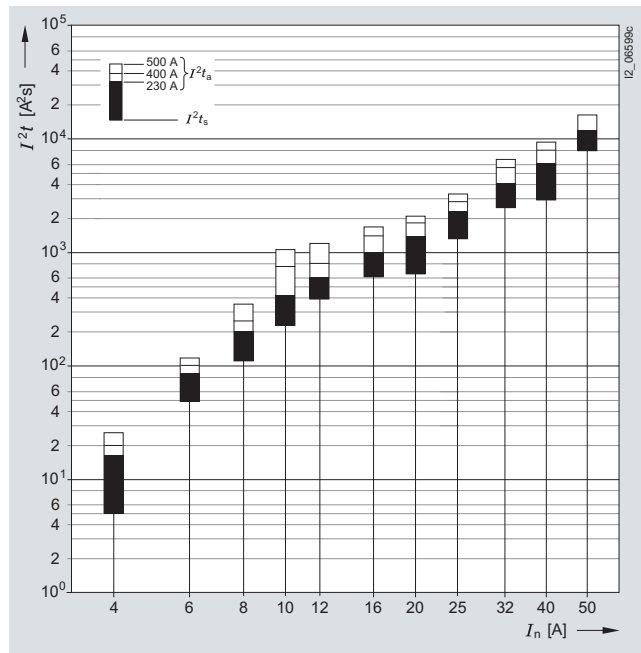

Type	I_n A	P_v W	$\Delta\theta$ K	I^2t_a			
				1 ms A^2s	230 V AC A^2s	400 V AC A^2s	500 V AC A^2s
3NW6 104-1	4	1.9	19	5	16	20	26
3NW6 101-1	6	2.5	25	48	85	100	120
3NW6 108-1	8	2.4	18	110	200	250	350
3NW6 103-1	10	0.8	12	230	420	750	1050
3NW6 106-1	12	1.0	16	390	600	800	1200
3NW6 105-1	16	1.6	27	600	1000	1400	1700
3NW6 107-1	20	2.3	32.5	670	1400	1800	2100
3NW6 116-1	25	2.2	31.5	1300	2300	2800	3200
3NW6 112-1	32	3.2	39.5	2500	4100	5500	6500
3NW6 117-1	40	4.5	48	3600	6100	8000	9200
3NW6 120-1	50	4.8	55	8000	12200	16000	--

Cylindrical fuse links and cylindrical fuse holders, 3NW6, 3NW7, 3NW8

Series 3NW6 2

Size: 22 mm × 58 mm
 Operational class: gG
 Rated voltage: 500 V AC (8 ... 80 A),
 400 V AC (100 A)
 Rated current: 8 ... 100 A

Time/current characteristics diagram

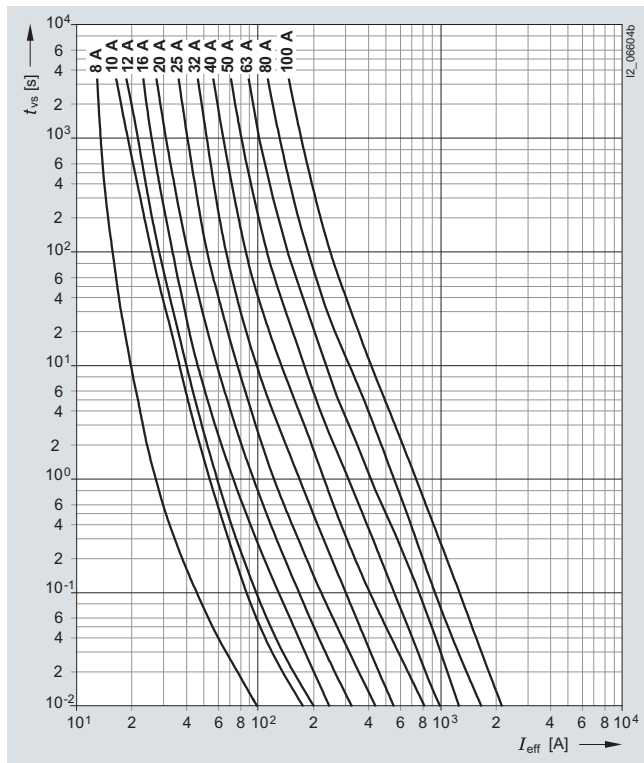

Current limitation diagram

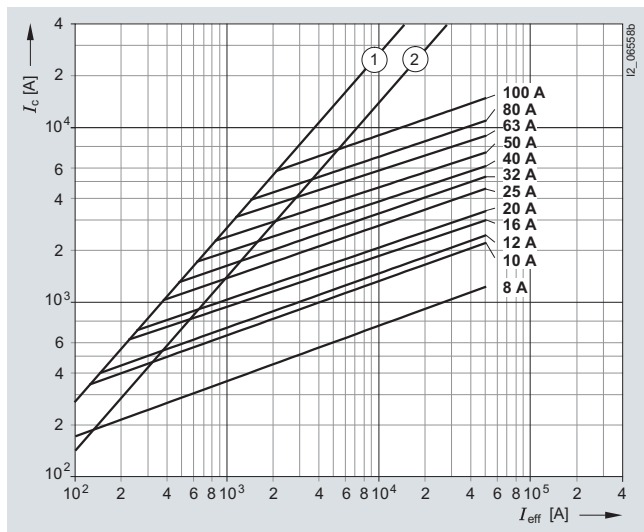

- ① Peak short-circuit current with largest DC component
- ② Peak short-circuit current without DC component

Melting I^2t values diagram

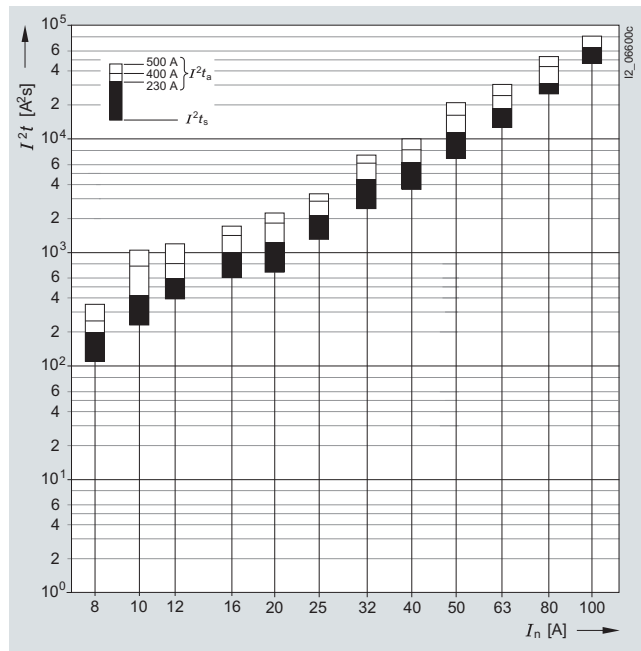

Type	I_n	P_v	$\Delta\theta$	I^2t_s	I^2t_a		
	A	W	K	1 ms A ² s	230 V AC A ² s	400 V AC A ² s	500 V AC A ² s
3NW6 208-1	8	2.5	15	110	200	170	350
3NW6 203-1	10	0.9	10.5	230	420	760	1050
3NW6 206-1	12	1.1	12	390	600	800	1200
3NW6 205-1	16	1.6	14.5	600	1000	1400	1700
3NW6 207-1	20	2.4	22.5	670	1200	1800	2200
3NW6 210-1	25	2.7	24	1300	2100	2800	3300
3NW6 212-1	32	3.2	28	2450	4400	6100	7200
3NW6 217-1	40	4.9	35	3600	6200	8000	10000
3NW6 220-1	50	5.9	46	6800	11400	16200	20600
3NW6 222-1	63	6.8	48	12500	18800	24000	30000
3NW6 224-1	80	7.5	48	24700	30500	43000	52500
3NW6 230-1	100	8.4	55	46000	64700	80000	--

Fuse Systems

Cylindrical fuse links and cylindrical fuse holders, 3NW6, 3NW7, 3NW8

Series 3NW6 30.-1

Size: 8 mm × 32 mm
 Operational class: gG
 Rated voltage: 400 V AC
 Rated current: 2 ... 20 A

Time/current characteristics diagram

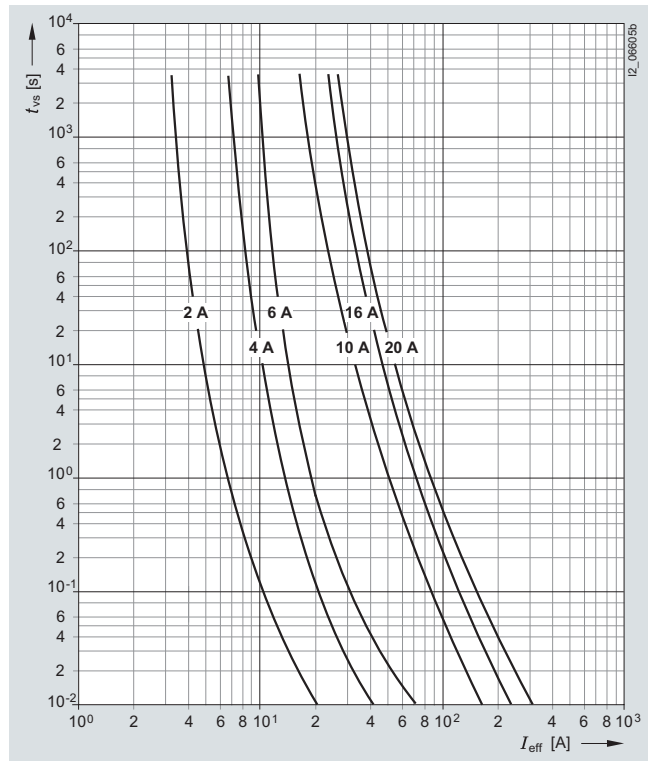

Current limitation diagram

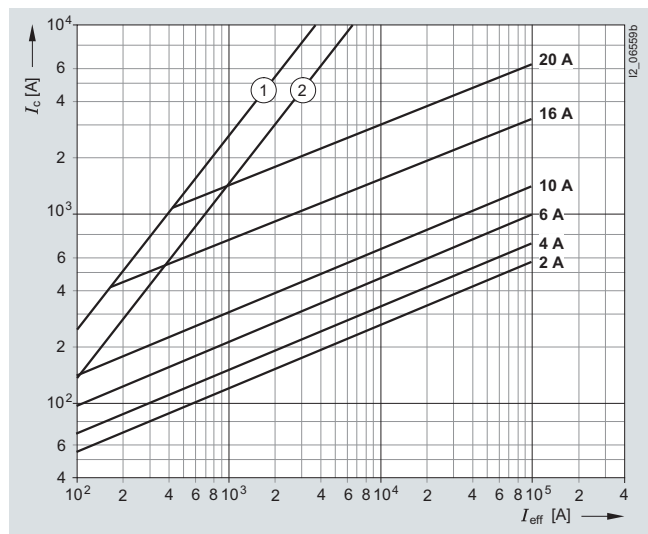

- ① Peak short-circuit current with largest DC component
- ② Peak short-circuit current without DC component

Melting I^2t values diagram

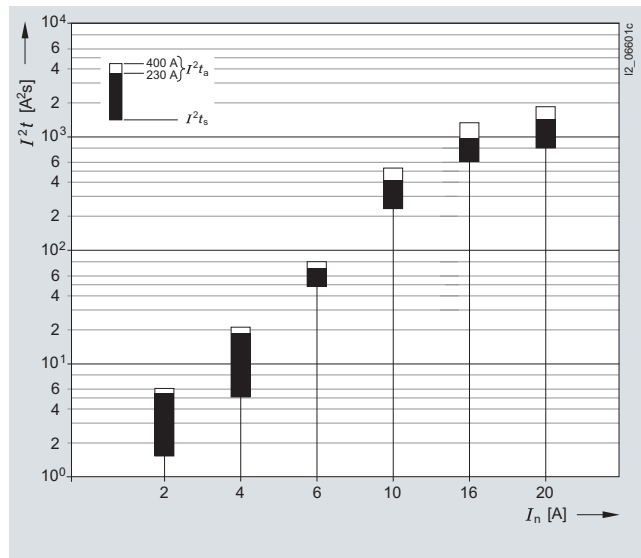

Type	I_n A	P_v W	$\Delta\theta$ K	I^2t_s 1 ms A ² s	I^2t_a 400 V AC A ² s
3NW6 302-1	2	2	27	1.6	6
3NW6 304-1	4	1.5	19	5	21
3NW6 301-1	6	1.5	20.5	48	85
3NW6 303-1	10	0.7	15	230	530
3NW6 305-1	16	1.1	29	600	1400
3NW6 307-1	20	1.7	34.5	790	1800

Cylindrical fuse links and cylindrical fuse holders, 3NW6, 3NW7, 3NW8

Series 3NW8

Sizes: 10 mm × 38 mm
 14 mm × 51 mm
 22 mm × 58 mm

Operational class: aM

Rated voltage: 500 V AC,
 400 V AC (3NW8 120-1, 3NW8 230-1)

Rated current: 0.5 ... 100 A

Time/current characteristics diagram

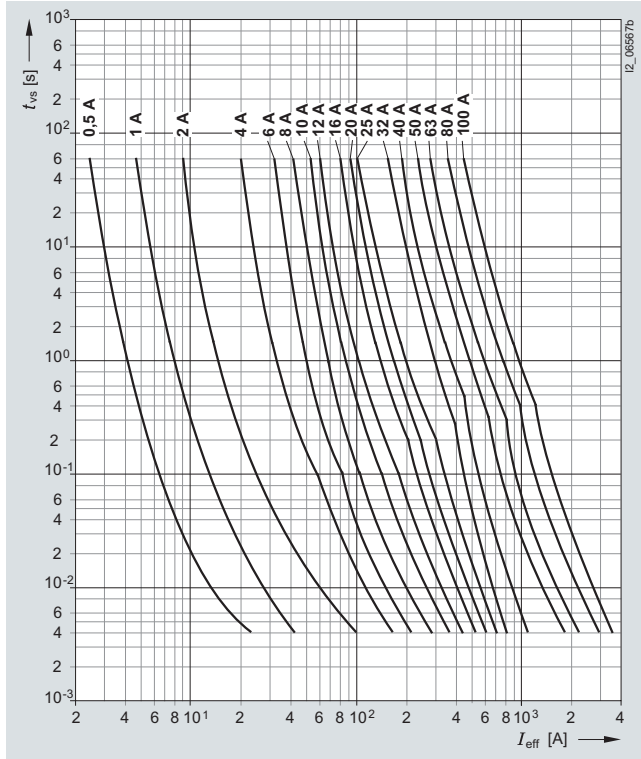

Melting I²t values diagram

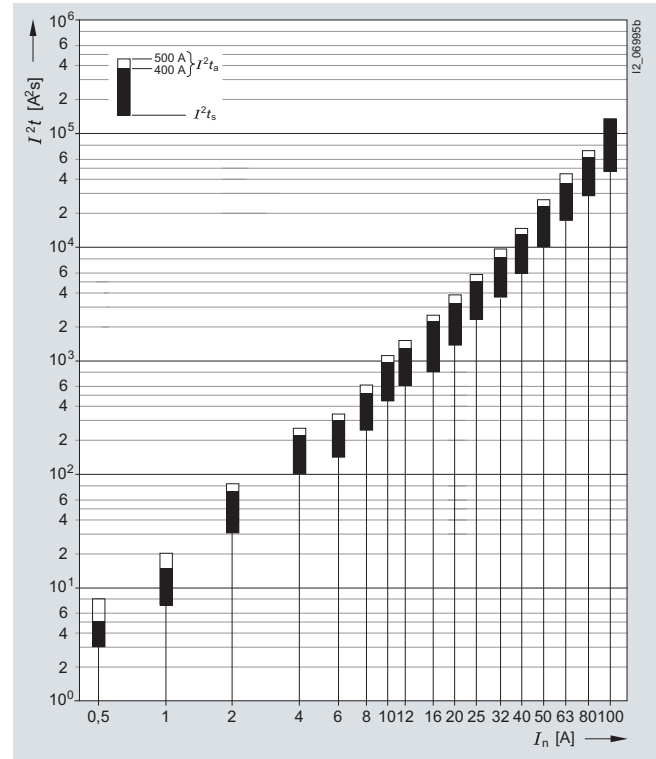

Current limitation diagram

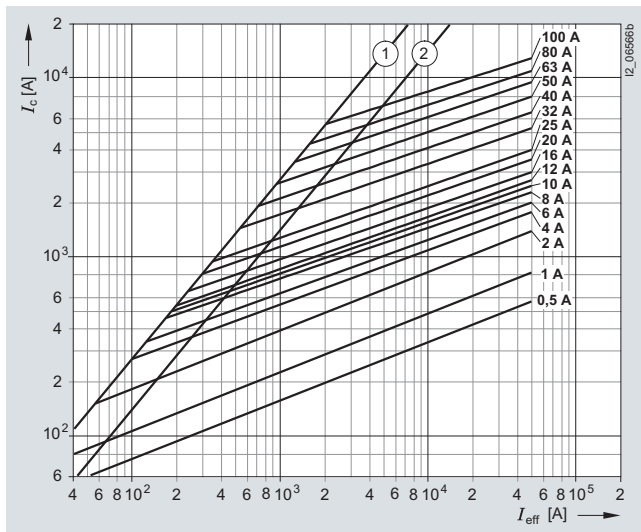

- ① Peak short-circuit current with largest DC component
- ② Peak short-circuit current without DC component

Fuse Systems

Cylindrical fuse links and cylindrical fuse holders, 3NW6, 3NW7, 3NW8

Series 3NW8

Sizes: 10 mm × 38 mm
14 mm × 51 mm
22 mm × 58 mm

Operational class: aM
Rated voltage: 500 V AC
400 V AC (3NW8 120-1, 3NW8 230-1)
Rated current: 0.5 ... 100 A

Time/current characteristics diagram

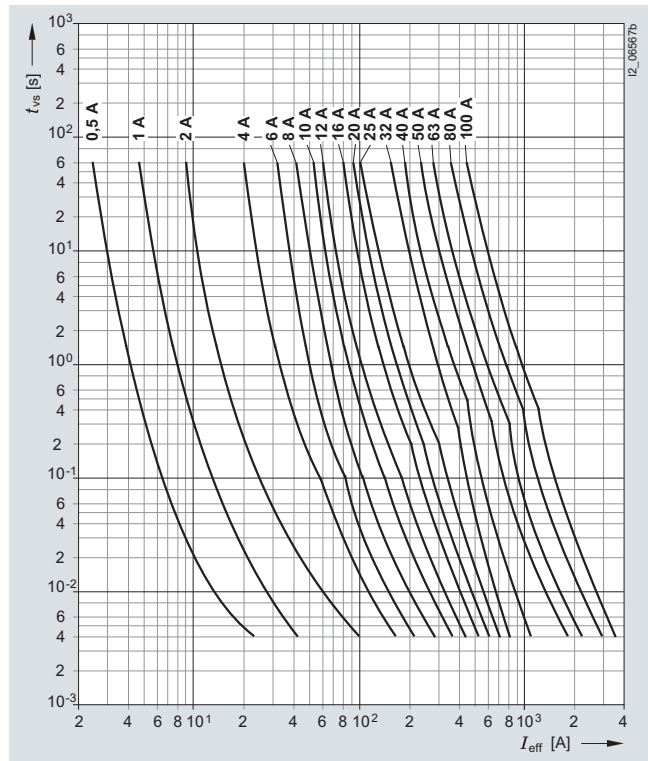

Melting I^2t values diagram

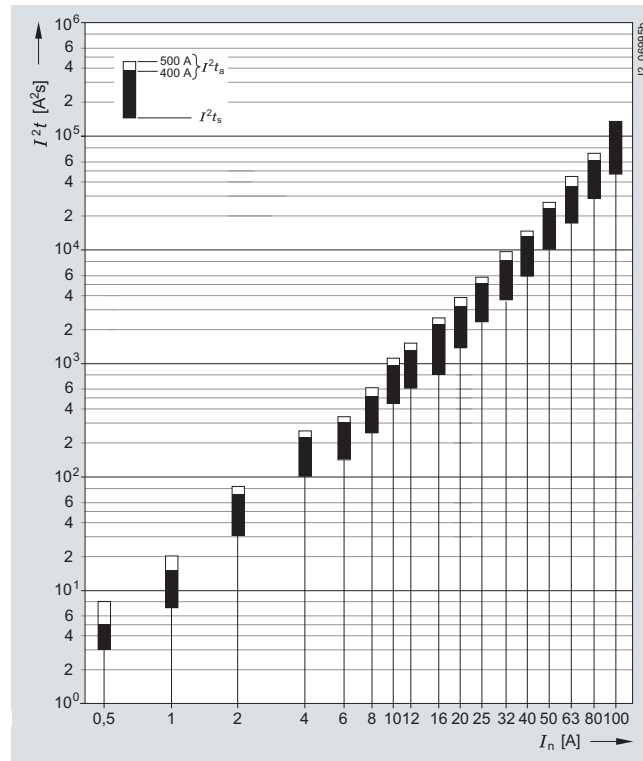

Current limitation diagram

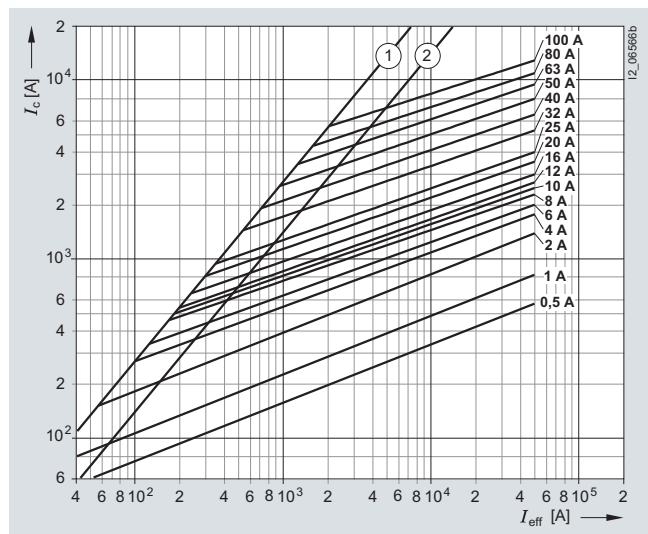

- ① Peak short-circuit current with largest DC component
- ② Peak short-circuit current without DC component

Compact fuse holders for motor starter combinations, 3NW7

Overview

Fused motor starter combinations can be configured with the fuse holders. The contactor and the fuse holder can be mounted directly next to each other.

The strong current-limiting fuses ensure a type 2 protection level (coordination according to IEC 60947-4, no damage protection) for the contactor.

The UL version has an SCCR value of 200 kA.

The accessories are generally UL-certified.

Customers can mount an auxiliary switch which signals the switching state or prevents the fuse holder from switching off under load by interrupting the contactor control, thus increasing safety for the operator and process.

Busbars and a matching three-phase feeder terminals complete the product range.



Cylindrical fuse holder Class CC with signal detector and mounted auxiliary switch



Installation configuration of a cylindrical fuse holder and a SIRIUS contactor on busbar adapter for the 60 mm busbar system.

Technical specifications

		Cylindrical fuse holders	
		3NW7 0...-1	3NW7 5...-1HG
Sizes	mm x mm	10 x 38	Class CC
Standards		IEC 60269; UL 512; CSA	UL 512; CSA
Approvals		UL, UL File Number E171267	UL, UL File Number E171267
• Acc. to UL			
• Acc. to CSA			
Rated voltage U_n	V AC	690	600
Rated current I_n	A AC	32	30
Rated short-circuit strength	kA	120 (at 500 V) 80 (at 690 V)	200
Switching capacity		AC-20B (switching without load)	--
• Utilization category			
Rated impulse withstand voltage	kV	6	
Overvoltage category		III	
Pollution degree		2	
Max. power dissipation of the fuse link	W	3	
No-voltage changing of fuse links	°C	-5 ... +40, humidity 90 % at +20	
Sealable when installed		Yes	
lockable with padlock		Yes	
Mounting position		Any, but preferably vertical	
Current direction		any	
Degree of protection	Acc. to IEC 60529	IP20, with connected conductors	
Terminals with touch protection according to BGV A3 at incoming and outgoing feeder		Yes	
Ambient temperature	°C	-5 ... +40, humidity 90 % at +20	
Conductor cross-sections			
• Finely stranded, with end sleeve	mm ²	1 ... 4	
• AWG cables (American Wire Gauge)	AWG	18 ... 10	
Tightening torques			
• Terminal screws	Nm	1.5	
	lb. in	13	
		PZ2	

Compact fuse holders for motor starter combinations, 3NW7

		Auxiliary switches 3NW7 903-1							
Standards		IEC 60947							
Approvals		UL, UL 508, UL File Number E334003							
Utilization category		AC-12		DC-13			AC-15		Acc. to UL
Rated voltage U_n	V AC	250	--	--	--	24	120	240	240
	V DC	--	24	120	240	--	--	--	--
Rated current I_n	A		2	0.5	0.25	4	3	1.5	5

		Busbars 5ST2 60.	
For cylindrical fuse holders		3NW7 0...-1	3NW7 5...-1HG
Pin spacing	mm	15	
Standards		EN 60974-1, VDE 0660 part 100, IEC 60947-1:2004, UL 508, CSA 22.2	
Approvals		UL, UL 4248-1, UL File Number E337131	
Busbar material		E-Cu 58 F25	
Partition material		PA66-V0	
Lamp wire resistance /1.5 mm²	°C	960	
Insulation coordination		Overvoltage category III, degree of pollution 2	
Rated voltage U_n • Acc. to UL • Acc. to IEC	V AC	--	600
	V AC	690	--
Maximum busbar current I_n • Acc. to UL • Acc. to IEC	A	--	65
	A	80	--

		Terminal 5ST2 600	
For cylindrical fuse holders		3NW7 0...-1	3NW7 5...-1HG
Pin spacing	mm	15	
Standards		IEC 60999:2000, UL 508	
Approvals		UL, UL 4248-1, UL File Number E337131	
Enclosure/cover material		PA66-V0	
Lamp wire resistance /1 mm²	°C	960	
Temperature resistance PA66-V0, HDT B ISO 179, UL 94-V0/1.5	°C	200	
Insulation coordination		Overvoltage category III, degree of pollution 2	
Max. operational voltage U_{max} • Acc. to UL • Acc. to IEC	V AC	--	600
	V AC	690	--
Maximum electrical load I_{max} • Acc. to UL • Acc. to IEC	A	--	65
	A	80	--
Rated current I_n	A	63	
Conductor cross-sections • solid/stranded • Finely stranded, with end sleeve		mm ²	2.5 ... 35
		mm ²	2.5 ... 25
Tightening torque of clamping screw	Nm	2.5 ... 3.5	

Compact fuse holders for motor starter combinations, 3NW7

Dimensional drawings

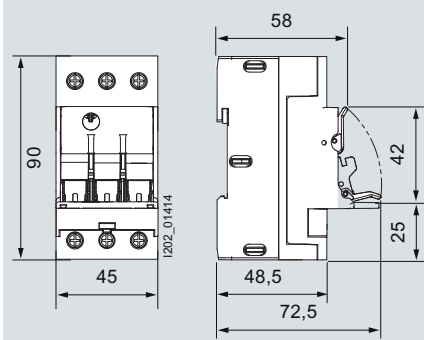

3NW7 03.-1
3NW7 53.-1HG

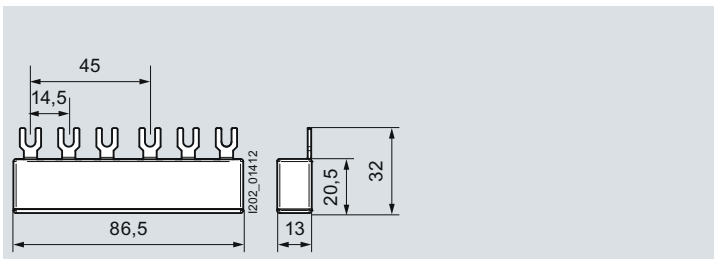

5ST2 60.

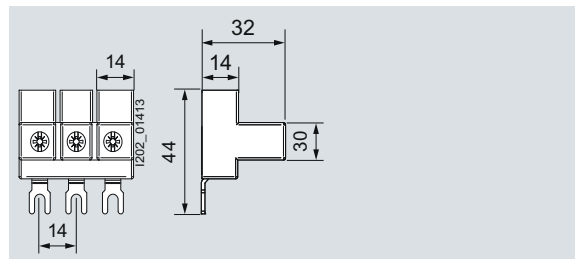

5ST2 600

Schematics

Circuit diagrams

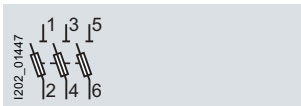

3NW7 03.-1
3NW7 53.-1HG



3NW7 903-1

Fuse Systems

Class CC fuse system, 3NW7, 3NW1, 3NW2, 3NW3

Overview

Class CC fuses are used for "branch circuit protection".

The enclosed fuse holders are designed and tested to comply with the US National Electrical Code NEC 210.20(A). This means that when subject to continuous operation, only 80 % of the rated current is permissible as operational current.

An operational current of 100 % of the rated current (30 A) is only permissible short-time.

The devices are prepared for the inscription labels of the ALPHA FIX terminal blocks 8WH8 120-7AA15 and 8WH8 120-7XA05.

There are three different series:

- Characteristic: slow 3NW1 ...-0HG
For the protection of control transformers, reactors, inductances. Significantly slower than the minimum requirements specified by UL for Class CC Fuses of 12 s at $2 \times I_n$.
- Characteristic: quick 3NW2 ...-0HG
For a wide range of applications, for the protection of lighting installations, heating, control systems.
- Characteristic: slow, current-limiting, 3NW3 ...-0HG
Slow for overloads and quick for short circuits. High current limitation for the protection of motor circuits.

Technical specifications

		Class CC fuse holders 3NW7 5.3-0HG		
Standards		UL 512; CSA C22.2		
Approvals		UL 512; UL File No. E171267; CSA C22.2		
Rated voltage	V AC	600		
Rated current I_n	A	30		
Max. power dissipation of fuse links				
• With cable, 6 mm ²	W	3		
• With cable, 10 mm ²	W	4.3		
Conductor cross-sections				
• Solid and stranded	mm ²	1.5 ... 25		
• AWG cables, solid and stranded	AWG	18 ... 4		

		Class CC fuse links		
		3NW1 ...-0HG	3NW2 ...-0HG	3NW3 ...-0HG
Standards		UL 248-4; CSA C22.2		
Approvals		UL 248-4; UL File Number E258218; CSA C22.2		
Characteristic		Slow	Quick	Slow, current limiting
Rated voltage	V AC	600	600	600
	V DC			150 (3 ... 15 A) 300 (< 3 A, > 15 A)
Rated breaking capacity	kA AC	200		

Dimensional drawings

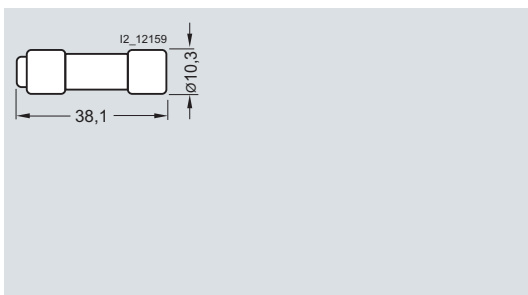

3NW1...-0HG
3NW2...-0HG
3NW3...-0HG

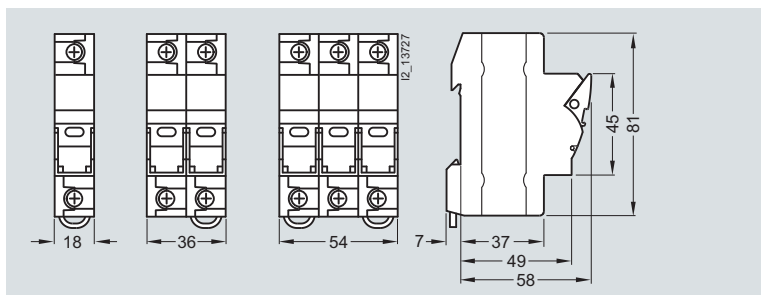

3NW7 5.3-0HG

Characteristic curves

Series 3NW1 ...-0HG

Time/current characteristics diagram

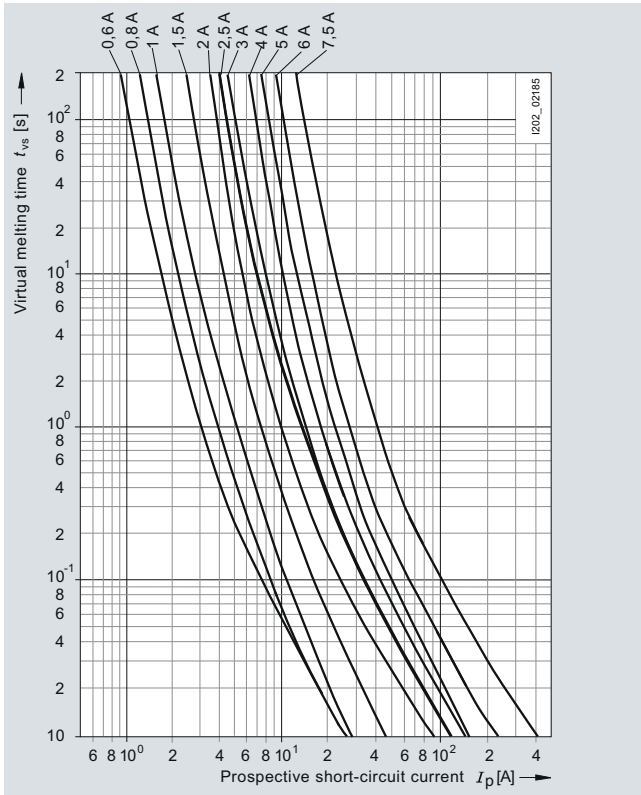

Series 3NW2 ...-0HG

Time/current characteristics diagram

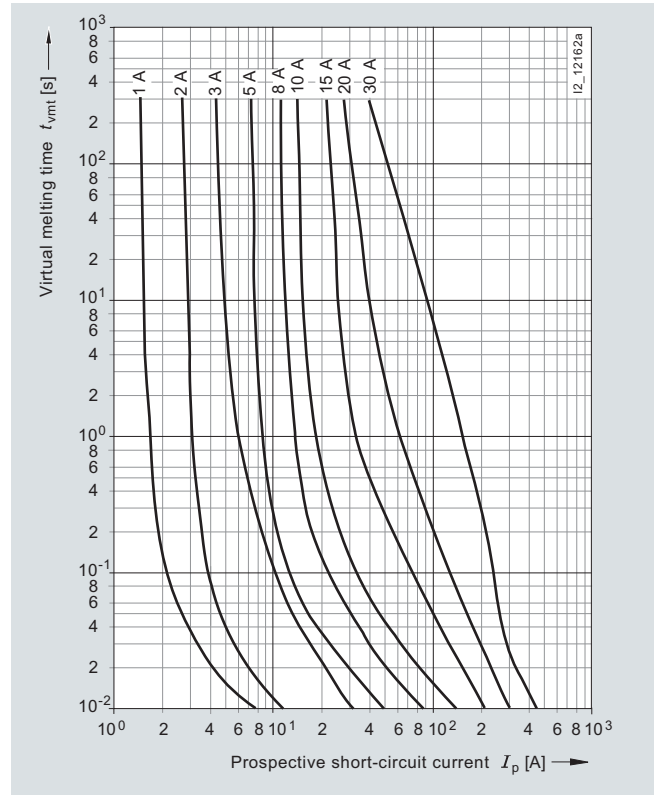

Series 3NW1 ...-0HG

Time/current characteristics diagram

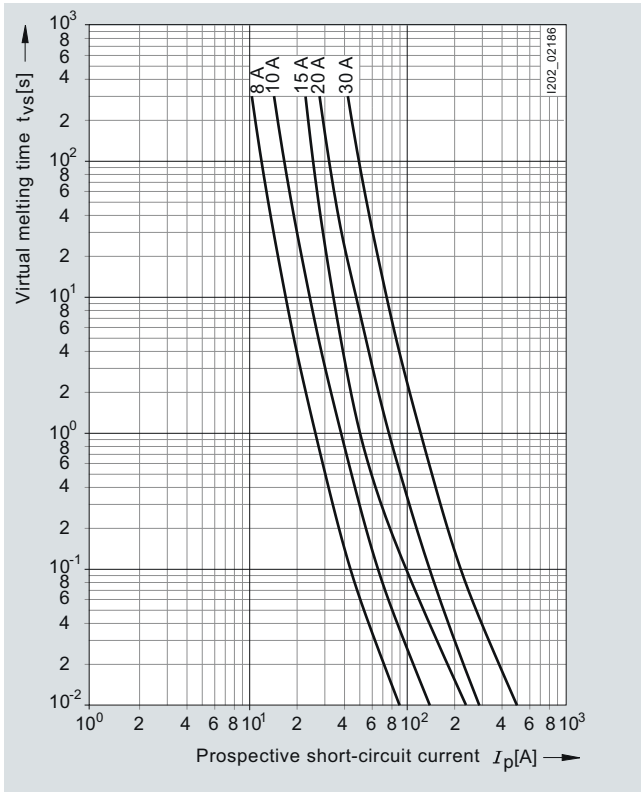

Series 3NW3 ...-0HG

Time/current characteristics diagram

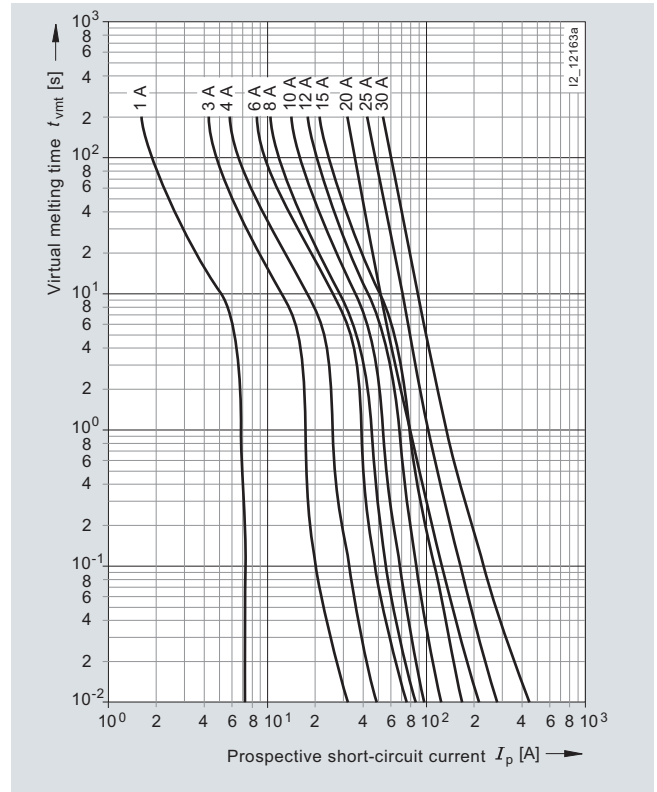

Fuse Systems

Class CC fuse system,
3NW7, 3NW1, 3NW2, 3NW3

Series 3NW3 ...-0HG

Current limitation diagram

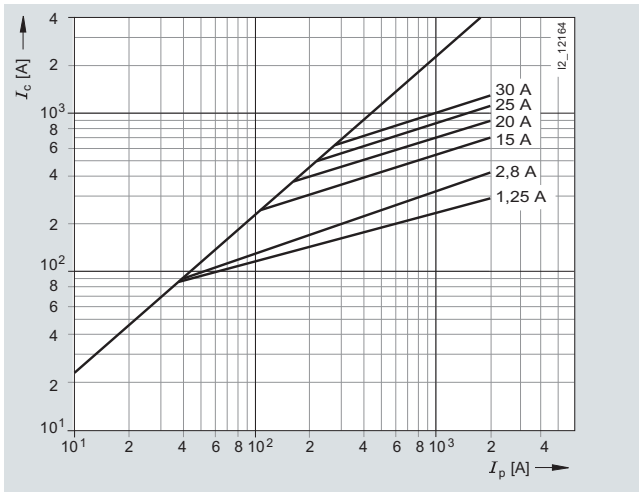

Overview

Busbars with pin-type connections can be used for NEOZED safety switching devices and fuse bases. Busbars in 10 mm² and 16 mm² versions are available.

Busbars with fork plugs are used for the most frequently used NEOZED fuse bases made of ceramic.

Technical specifications

		5ST, 5SH
Standards		EN 60439-1 (VDE 0660-500): 2005-01
Busbar material		SF-Cu F 24
Partition material		Plastic, Cycloy 3600 heat-resistant over 90 °C flame-retardant and self-extinguishing, dioxin and halogen-free
Rated operational voltage U_c	V AC	400
Rated current I_n		
• Cross-section 10 mm ²	A	63
• Cross-section 16 mm ²	A	80
Rated impulse withstand voltage U_{imp}	kV	4
Test pulse voltage (1.2/50)	kV	6.2
Rated conditional short-circuit current I_{cc}	kA	25
Resistance to climate		
• Constant atmosphere	Acc. to DIN 50015	23/83; 40/92; 55/20
• Humid heat	Acc. to IEC 60068-2-30	28 cycles
Insulation coordination		
• Overvoltage category		III
• Pollution degree		2
Maximum busbar current I_B/phase		
• Infeed at the start of the busbar		
- Cross-section 10 mm ²	A	63
- Cross-section 16 mm ²	A	80
• Infeed at the center of the busbar		
- Cross-section 10 mm ²	A	100
- Cross-section 16 mm ²	A	130

Fuse Systems

Busbar systems, 5ST, 5SH

5ST3 7...-HG busbars acc. to UL 508

		5ST3 7...-0HG	5ST3 7...-2HG	5ST3 770-0HG	5ST3 770-1HG
Standards		UL 508, CSA C22.2 No. 14-M 95			
Approvals		UL 508 File No. E328403 CSA			
Operational voltage					
• Acc. to IEC	V AC	690			
• Acc. to UL 489	V AC	600			
Rated conditional short-circuit current	kA	10 (RMS symmetrical 600 V for three cycles)			
• Dielectric strength	kV/mm	25			
• Surge strength	kV	> 9.5			
Rated current	A	--	--	115	
Maximum busbar current I_S/phase					
• Infeed at the start of the busbar	A	80	100	--	--
• Infeed at the center of the busbar	A	160	200	--	--
Insulation coordination					
• Overvoltage category		III			
• Pollution degree		2			
Busbar cross-section	mm ² Cu	18	25	--	--
Infeed		Any			
Conductor cross-sections	AWG mm ²	--	--	10 ... 1/0 6 ... 35	14 ... 1 1.5 ... 50
Terminals					
• Terminal tightening torque	Nm lbs/in	--	--	5 50	3.5 35

Infeed at the start of the busbar

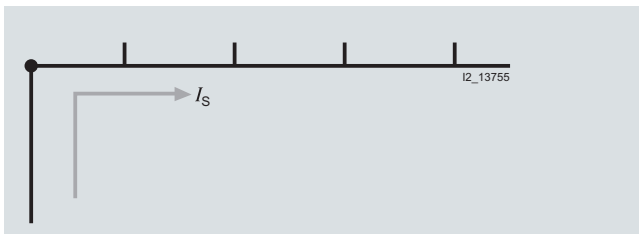

Infeed along the busbar or midpoint infeed

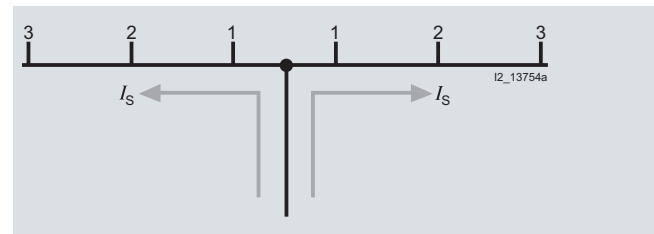

The sum of the output current per branch must not be greater than the busbar current $I_{S1,2}$ / phase.

Busbar systems, 5ST, 5SH

Dimensional drawings

5ST3 7

Pin spacing in MW (modular width; 1 MW = 18 mm)
Dimensions of side view in mm (approx.)

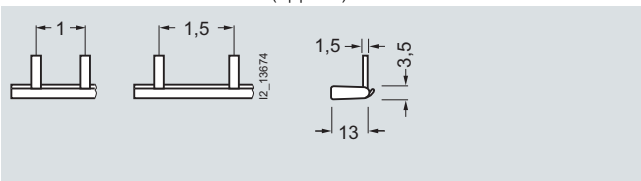

5ST3 700 5ST3 703
5ST3 701
Single-phase Single-phase

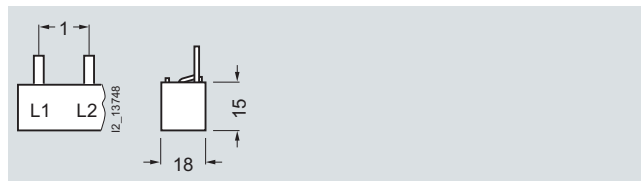

5ST3 704
5ST3 705

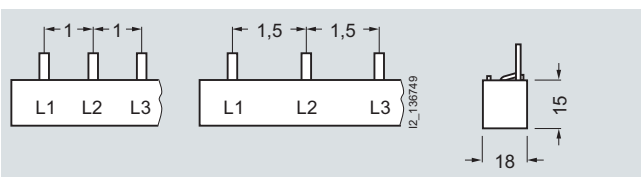

5ST3 708 5ST3 714
5ST3 710

5ST2

Fork spacing in MW (modular width; 1 MW = 18 mm)
Dimensions of side view in mm (approx.)

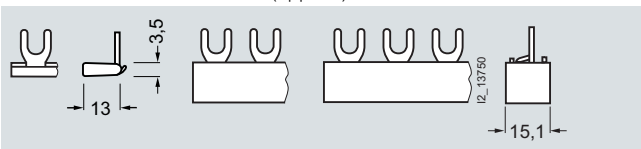

5ST2 186 5ST2 187 5ST2 188
5ST2 190 5ST2 191 5ST2 192

Busbars for DIAZED EZR fuse bases

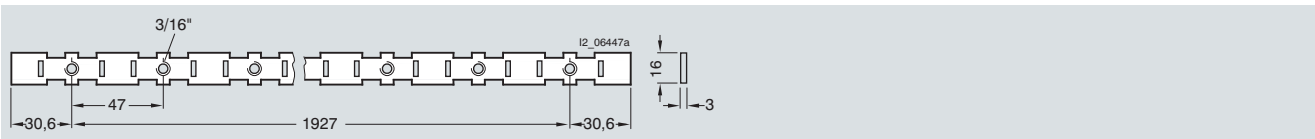

5SH3 54

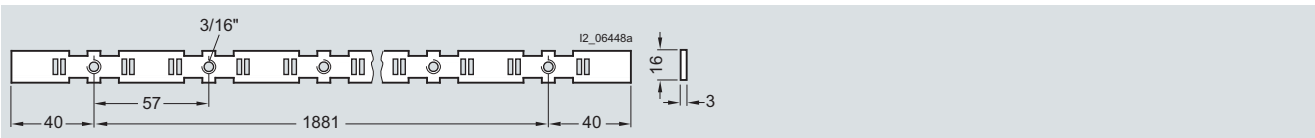

5SH3 55

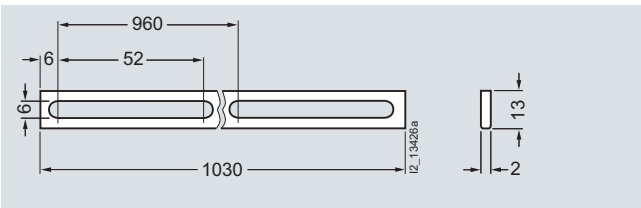

5SH3 500

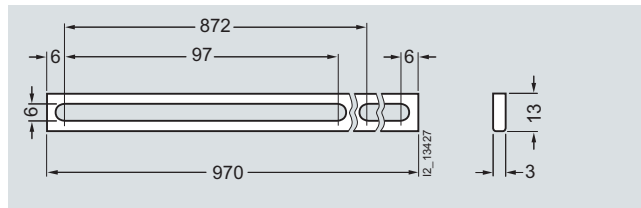

5SH3 501

5SH5

Fork spacing in MW (modular width; 1 MW = 18 mm), dimensions of side views in mm (approx.)

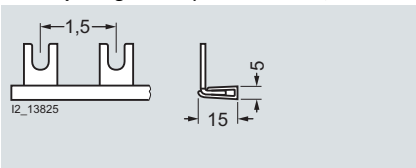

5SH5 517

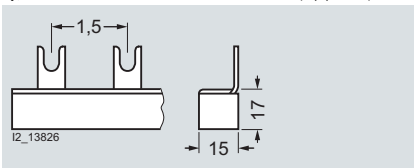

5SH5 320

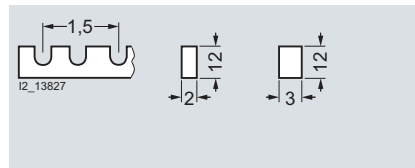

5SH5 321 5SH5 322

Fuse Systems

Busbar systems, 5ST, 5SH

5ST3 7 . . . HG busbars acc. to UL 508

5ST3 7
Pin spacings in MW (modular width 1 MW = 18 mm)
 Dimensions of side view in mm (approx.)

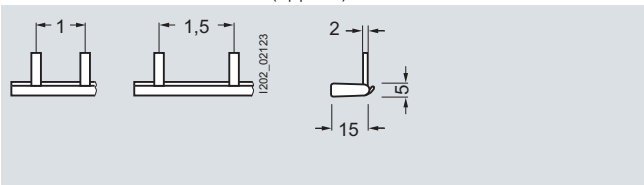

5ST3 701-0HG 5ST3 703-0HG

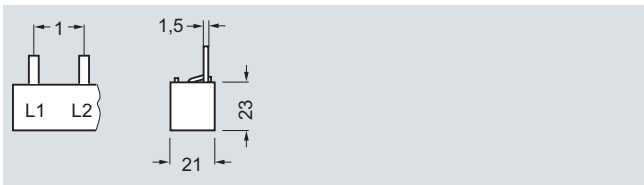

5ST3 705-0HG

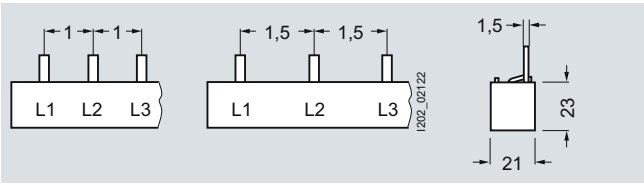

5ST3 710-0HG 5ST3 714-0HG

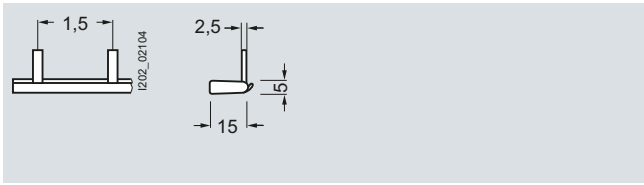

5ST3 701-2HG

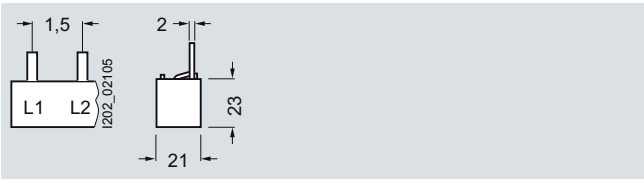

5ST3 705-2HG

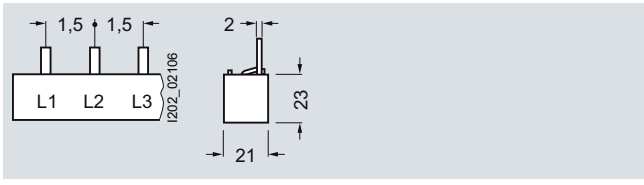

5ST3 710-2HG

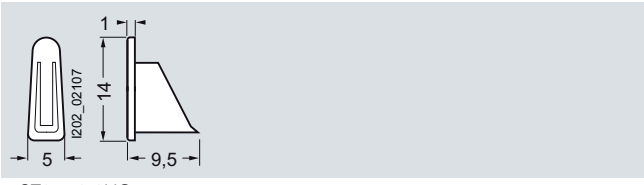

5ST3 748-0HG

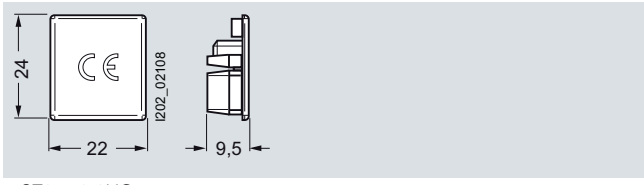

5ST3 750-0HG

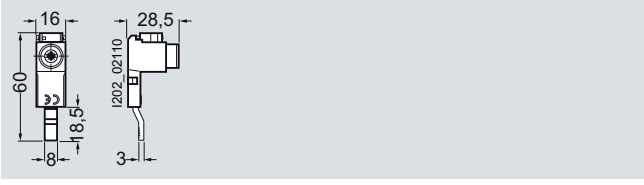

5ST3 770-0HG

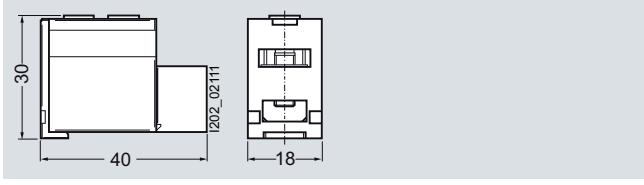

5ST3 770-1HG

5ST3 6 touch protection covers
Pin spacings in MW (modular width 1 MW = 18 mm)
 Dimensions of side view in mm (approx.)

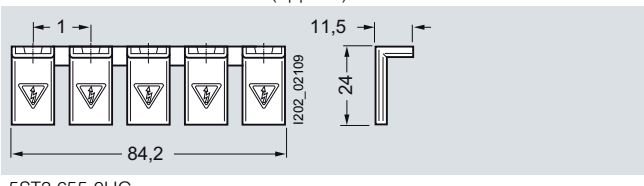

5ST3 655-0HG

Overview

LV HRC fuse systems (NH type) are used for installation systems in non-residential, commercial and industrial buildings as well as in systems of power supply companies. They therefore protect essential building parts and installations.

NH fuse systems are fuse systems designed for operation by experts. There are no constructional requirements for non-interchangeability of rated current and touch protection.

The components and auxiliary equipment are designed in such a way as to ensure the safe replacement of NH fuses or isolation of systems.

LV HRC fuse links are available in the sizes 000, 00, 0, 1, 2, 3, 4 and 4a.

LV HRC fuse links are available in the following operational classes:

- gG for cable and line protection
- aM for the short-circuit protection of switching devices in motor circuits
- gR or aR for the protection of power semiconductors
- gS: The new gS operational class combines cable and line protection with semiconductor protection.

LV HRC fuse links of size 000 can also be used in LV HRC fuse bases, LV HRC fuse switch disconnectors, LV HRC fuse strips as well as LV HRC in-line fuse switch disconnectors of size 00.

The fuse links 300 A, 355 A and 425 A comply with the standard but do not have the VDE mark.

LV HRC components:

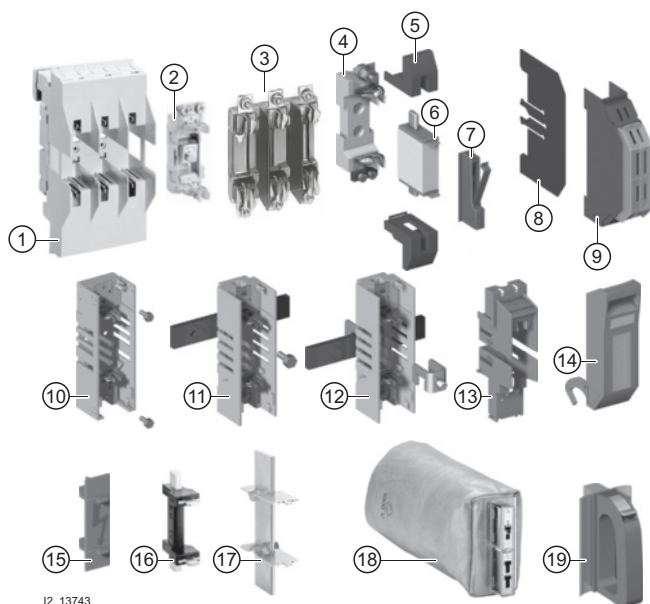

12_13743

- ① LV HRC fuse bases from the SR60 busbar system
- ② LV HRC fuse bases for busbar mounting
- ③ LV HRC fuse bases, 3P
- ④ LV HRC fuse bases, 1P
- ⑤ LV HRC contact covers
- ⑥ LV HRC fuse links
- ⑦ LV HRC signal detectors
- ⑧ LV HRC partitions
- ⑨ LV HRC protective covers
LV HRC fuse bases with swivel mechanism
- ⑩ - For screw fixing on mounting plates
- ⑪ - For screw fixing on busbar systems
- ⑫ - For claw fixing on busbars
- ⑬ LV HRC protective cover for LV HRC fuse bases with swivel mechanism
- ⑭ LV HRC swivel mechanisms
- ⑮ LV HRC fuse base covers
- ⑯ LV HRC isolating blades with insulated grip lugs
- ⑰ LV HRC isolating blades with non-insulated grip lugs
- ⑱ LV HRC fuse pullers with sleeve
- ⑲ LV HRC fuse pullers

Fuse Systems

LV HRC Fuse Systems

LV HRC fuse links, 3NA, 3ND

Technical specifications

		LV HRC fuse links					Operational class
		gG					aM
		3NA6 ...-4 3NA6 ...-4KK 3NA3 83-8	3NA6 ... 3NA6 ...-7 3NA7 ... 3NA7 ...-7	3NA3 ... 3NA3 ...-7	3NA6 ...-6 3NA7 ...-6	3NA3 ...-6	3ND1 3ND2
Standards		IEC 60269-1, -2; EN 60269-1; DIN VDE 0636					
Approvals		DIN VDE 0636-2; CSA 22.2 No.106, File Number 016325_0_00 (CSA approval of fuses 500 V for 600 V)					
Rated voltage U_n							
• Sizes 000 and 00	V AC	400	500	500	690	690	500
	V DC	--	250	250	250	250	--
• Sizes n 1 and 2	V AC	400	500	500	690	690	690
	V DC	--	440	440	440	440	--
• Size 3	V AC			500		690	690
	V DC			440		440	
• Sizes 4 and 4a (IEC design)	V AC			500		--	
	V DC			400		--	
Rated current I_n	A	10 ... 400	2 ... 400	2 ... 1250	2 ... 315	2 ... 500	6 ... 630
Rated breaking capacity	kA AC	120					
	kA DC	--	25				--
Contact pins		Non-corroding, silver-plated					
Resistance to climate	°C	-20 ... +50 at 95 % relative humidity					

Dimensional drawings

LV HRC fuse links, operational class gG

Sizes 000 to 3 and 4a

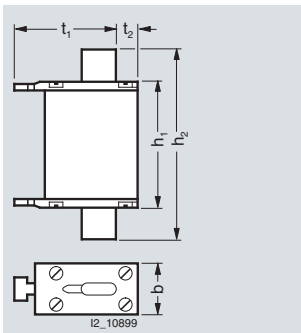

Size 4 (IEC design)

Sizes	I_n A	U_n V	Type	Dimensions				
				b	h_1	h_2	t_1	t_2
000	2 ... 35	690 AC/250 DC	3NA3 8..-6	21	54	80	45	8
	2 ... 160	500 AC	3NA3 8../-8					
	2 ... 100	500 AC/250 DC	3NA6 8..					
	10 ... 100	400 AC	3NA6 8..-4					
	2 ... 35	690 AC/250 DC	3NA6 8..-6					
	10 ... 100	500 AC/250 DC	3NA7 8..					
	2 ... 35	690 AC/250 DC	3NA7 8..-6					
00	35 ... 160	500 AC/250 DC	3NA3 8..	30	54	80	45	14
	40 ... 100	690 AC/250 DC	3NA3 8..-6					
	80 ... 160	500 AC/250 DC	3NA6 8../-7					
	80 ... 160	400 AC	3NA6 8..-4 (KK)					
	40 ... 100	690 AC/250 DC	3NA6 8..-6					
	80 ... 160	500 AC/250 DC	3NA7 8../-7					
	40 ... 100	690 AC/250 DC	3NA7 8..-6					
0	6 ... 160	500 AC/440 DC	3NA3 0..	30	67	126	45	14

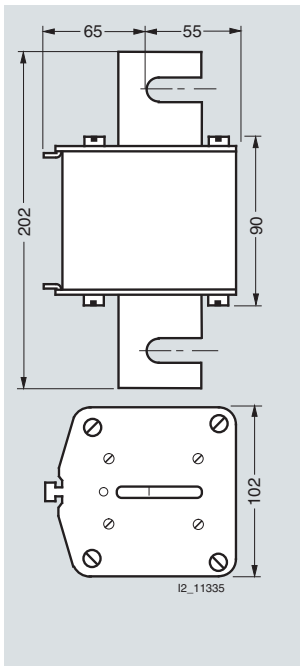

1	16 ... 160	500 AC/440 DC	3NA3 1..	30	75	137	50	15					
	50 ... 160	690 AC/440 DC	3NA3 1..-6										
	16 ... 160	500 AC/440 DC	3NA6 1..										
	35 ... 160	400 AC	3NA6 1..-4										
	50 ... 160	690 AC/440 DC	3NA6 1..-6										
	16 ... 160	500 AC/440 DC	3NA7 1..										
	50 ... 160	690 AC/440 DC	3NA7 1..-6										
	200 ... 250	500 AC/440 DC	3NA3 1..						47	75	137	51	9
	200	690 AC/440 DC	3NA3 1..-6										
	200 ... 250	500 AC/440 DC	3NA6 1..										
	200 ... 250	400 AC	3NA6 1..-4										
	200	690 AC/440 DC	3NA6 1..-6										
	200 ... 250	500 AC/440 DC	3NA7 1..										
	200	690 AC/440 DC	3NA7 1..-6										
2	35 ... 250	500 AC/440 DC	3NA3 2..	47	75	151	58	10					
80 ... 200	690 AC/440 DC	3NA3 2..-6											
35 ... 250	500 AC/440 DC	3NA6 2..											
50 ... 250	400 AC	3NA6 2..-4											
80 ... 200	690 AC/440 DC	3NA6 2..-6											
35 ... 250	500 AC/440 DC	3NA7 2..											
80 ... 200	690 AC/440 DC	3NA7 2..-6											
300 ... 400	500 AC/440 DC	3NA3 2..	58						74	151	59	13	
224 ... 250	690 AC/440 DC	3NA3 2..-6											
300 ... 400	500 AC/440 DC	3NA6 2..											
300 ... 400	400 AC	3NA6 2..-4											
224 ... 315	690 AC/440 DC	3NA6 2..-6											
300 ... 400	500 AC/440 DC	3NA7 2..											
224 ... 315	690 AC/440 DC	3NA7 2..-6											
3	200 ... 400	500 AC/440 DC		3NA3 3..	58	74	151	71					13
250, 315	690 AC/440 DC	3NA3 3..-6											
	425 ... 630	500 AC/440 DC	3NA3 3..	71	74	151	70	13					
	355 ... 500	690 AC/440 DC	3NA3 3..-6										
4	630 ... 1250	500 AC/440 DC	3NA3 4..	See adjacent drawing									
4a	500 ... 1250	500 AC/440 DC	3NA3 6..	102	97	201	95	20					

LV HRC fuse links, operational class aM

Size 000 to 3

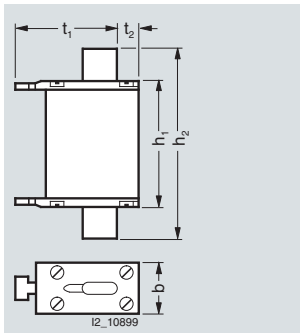

Sizes	I_n A	U_n V	Type	Dimensions				
				b	h_1	h_2	t_1	t_2
000	6 ... 80	500 AC	3ND1 8..	21	54	80	45	8
00	100 ... 160			30	54	80	45	14
1	63 ... 100	690 AC	3ND2 1..	30	75	137	50	15
	125 ... 250			47	75	137	51	9
2	125 ... 250	690 AC	3ND2 2..	47	75	151	58	10
	315 ... 400			58	74	151	59	13
3	315 ... 400	690 AC	3ND2 3..	58	74	151	71	13
	500, 630		3ND1 3..	71	74	151	70	13

Overview

Terminals for all applications

Terminals are as different as the requirements of individual systems.



Flat terminals with screws are suitable for connecting busbars or cable lugs. They have a torsion-proof screw connection with shim, spring washer and nut. When tightening the nut, always ensure compliance with the specified torque due to the considerable leverage effect.

The double busbar terminal differs from the flat terminal in that it supports connection of two busbars, one on the top and one at the bottom of the flat terminal.



With the flat terminal with nut, the terminal lug of the nut is torsion-proof. When tightening the nut, the torque must be observed because of the considerable leverage effect.



The plug-in terminal is equipped for connecting two conductors.

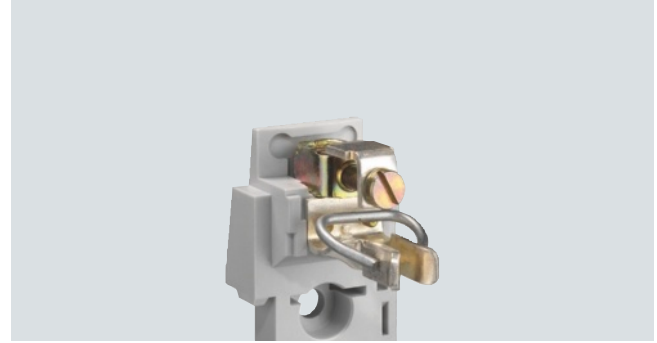

The modern box terminal ensures efficient and reliable connection to the conductors. They support connection of conductors with or without end sleeves.



Up to three conductors can be clamped to the terminal strip.



One conductor can be clamped to the saddle-type terminal.

Fuse Systems

LV HRC Fuse Systems

LV HRC bases and accessories,
3NH3, 3NG1, 3NX

Technical specifications

Size	LV HRC fuse bases, LV HRC bus-mounting bases						
	000/00	0	1	2	3	4	
Standards	IEC 60269-1, -2; EN 60269-1; DIN VDE 0636-2						
Rated current I_n	A	160	160	250	400	630	1250
Rated voltage U_n	V AC	690 ¹⁾	690 ¹⁾				690
	V DC	250	440				440
Rated short-circuit strength	kA AC	120					
	kA DC	25					
Flat terminal							
Screw		M8		M10		M12	
Nut		M8	--				
Max. tightening torque	Nm	14		38			65
Plug-in terminal							
Conductor cross-section	mm ²	2.5 ... 50		--			
Saddle-type terminal							
Conductor cross-section	mm ²	6 ... 70	--				
Box terminals							
Conductor cross-section	mm ²	2.5 ... 50					
Terminal strips							
Conductor cross-section, 3-wire	mm ²	1.5 ... 16	--				
Max. torque for attachment of LV HRC fuse base	Nm	2		2.5			--

¹⁾ Extended rated voltage up to 1000 V (except LV HRC bus-mounting bases).

Size	LV HRC fuse bases with swivel mechanism				
	000/00	1	3	4a	
Rated voltage U_n	V AC	690			
	V DC	440			
Power loss	W	4	5	20	32
Flat terminal					
Screw		M8	M10	M12	M16
Nut		M8	--		
Max. tightening torque	Nm	14	38		65

Dimensional drawings

LV HRC bases made of molded plastic

Size 000/00, 1P

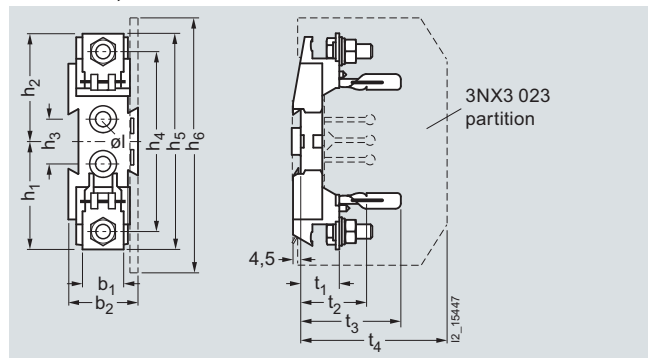

3NH3 051 to 3NH3 053

Sizes	I_n A	Poles	Connection	Type	b_1	b_2	h_1	h_2	h_3	h_4	h_5	h_6	$\varnothing l$	t_1	t_2	t_3	t_4
000/00	160	1P	M8 flat terminals, screw	3NH3 051	23	39	61	61	25	101	121	139	7.5	26	42	61	86
			Saddle-type terminal	3NH3 052	--	39	60	60	25	108	120	139	7.5	26	42	61	86
			Box terminals	3NH3 053	--	39	59	50	25	99	117	139	7.5	23	39	61	86

LV HRC bases made of ceramic

Size 000/00
1P

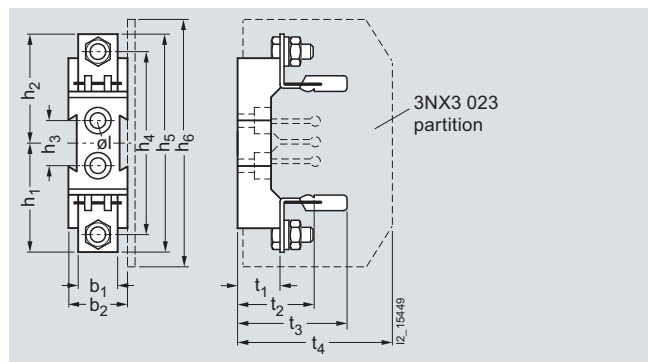

3NH3 03., 3NH3 050

3P

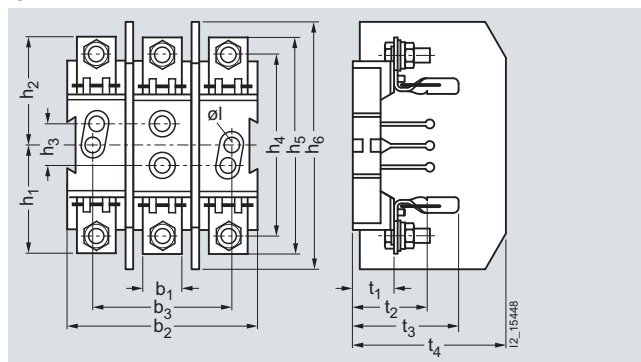

3NH4 03.

Sizes	I_n A	Poles	Connection	Type	b_1	b_2	b_3	h_1	h_2	h_3	h_4	h_5	h_6	$\varnothing l$	t_1	t_2	t_3	t_4
000/00	160	1P	Flat terminal, screw	3NH3 030	23	34	--	61	61	25	102	122	139	7.5	24	40	60	86
			M8 plug-in terminal	3NH3 031	31	34	--	64	64	25	102	128	139	7.5	24	40	60	86
			Saddle-type terminal	3NH3 032	29	34	--	61	61	25	109	122	139	7.5	24	40	60	86
			Flat terminal, terminal strip	3NH3 035	26	34	--	61	70	25	113	130	139	7.5	24	40	60	86
			Flat terminal, nut	3NH3 038	23	34	--	61	61	25	102	122	139	7.5	24	40	60	86
			Flat and saddle-type terminals	3NH3 050	29	34	--	61	61	25	102	122	139	7.5	24	40	60	86
		3P	Flat terminal	3NH4 030	23	102	70	61	61	25	102	122	139	7.5	24	40	60	86
			M8 plug-in terminal	3NH4 031	31	102	70	64	64	25	102	128	139	7.5	24	40	60	86
			Saddle-type terminal	3NH4 032	29	102	70	61	61	25	102	122	139	7.5	24	40	60	86
			Flat terminal, terminal strip	3NH4 035	26	102	70	61	70	25	113	130	139	7.5	24	40	60	86

Fuse Systems

LV HRC Fuse Systems

LV HRC bases and accessories, 3NH3, 3NG1, 3NX

Size 0, 1P

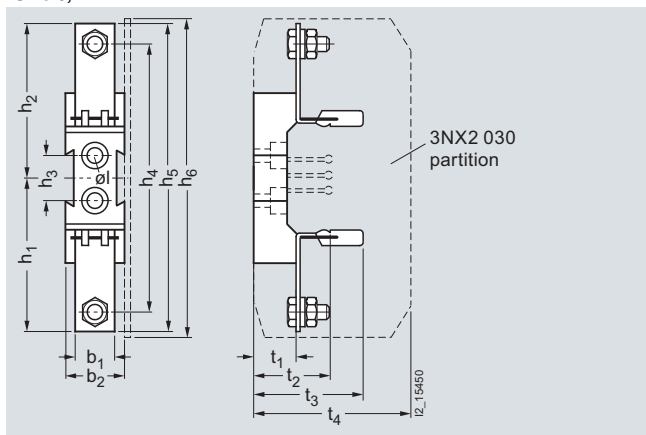

3NH3 12.

Sizes	I_n A	Poles	Connection	Type	b_1	b_2	h_1	h_2	h_3	h_4	h_5	h_6	$\varnothing l$	t_1	t_2	t_3	t_4
0	160	1P	Flat terminal	3NH3 120	23	38	87	87	25	150	173	179	7.5	24	40	60	88
			Plug-in terminal	3NH3 122	31	38	87	87	25	150	173	179	7.5	24	40	60	88

Size 1 1P

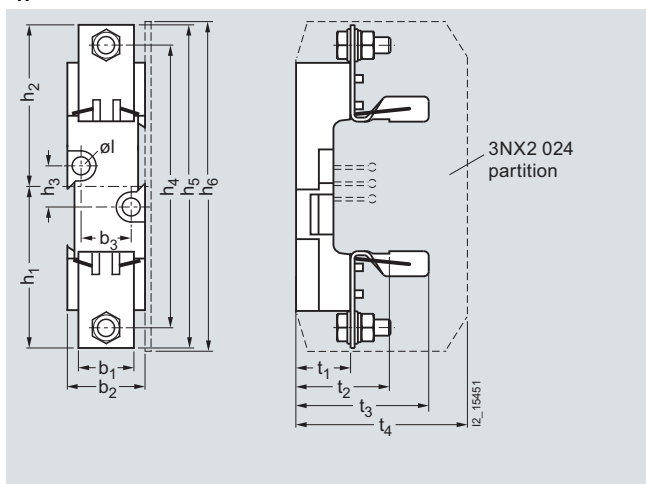

3NH3 2.0

3P

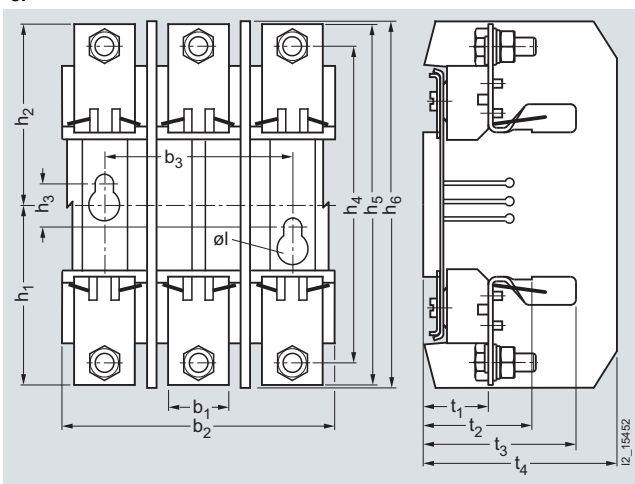

3NH4 230

Sizes	I_n A	Poles	Connection	Type	b_1	b_2	b_3	h_1	h_2	h_3	h_4	h_5	h_6	$\varnothing l$	t_1	t_2	t_3	t_4
1	250	1P	M10 flat terminal	3NH3 230	35	49	30	101	101	25	177	202	203	10.5	35	55	84	107
			Double busbar terminal	3NH3 220	35	49	30	101	101	25	177	202	203	10.5	35	55	84	107
		3P	M10 flat terminal	3NH4 230	35	146	111	101	101	25	177	202	203	10.5	35	55	84	107

Fuse Systems

LV HRC Fuse Systems

LV HRC bases and accessories,
3NH3, 3NG1, 3NX

Size 2
1P

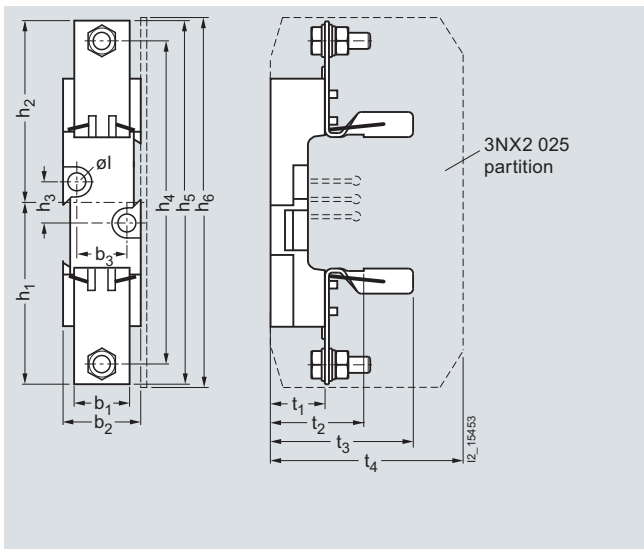

3NH3 3.0

Size 3
1P

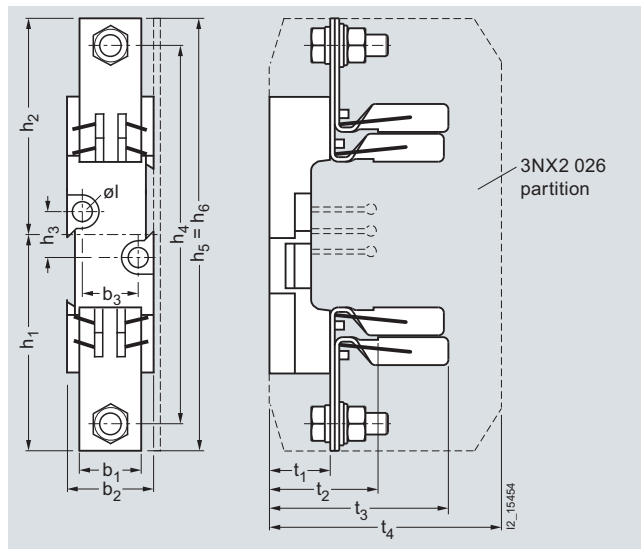

3NH3 4.0

Sizes	I_n A	Poles	Connection	Type	b_1	b_2	b_3	h_1	h_2	h_3	h_4	h_5	h_6	$\varnothing l$	t_1	t_2	t_3	t_4
2	400	1P	M10 flat terminal	3NH3 330	35	49	30	113	113	25	202	227	228	10.5	35	55	90	115
			Double busbar terminal	3NH3 320	35	49	30	113	113	25	202	227	228	10.5	35	55	90	115
3	630	1P	M12 flat terminal	3NH3 430	35	49	30	121	121	25	212	242	242	10.5	35	57	101	130
			Double busbar terminal	3NH3 420	35	49	30	121	121	25	212	242	242	10.5	35	57	101	130

Size 4, 1P

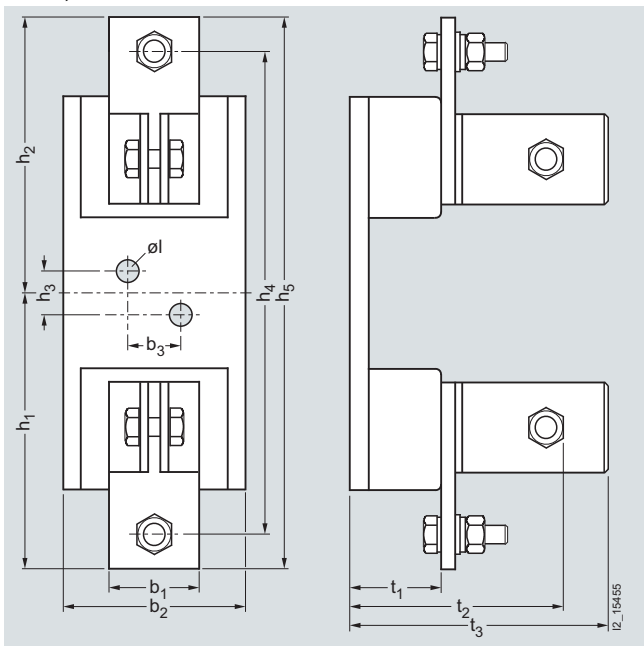

3NH3 530

Sizes	I_n A	Poles	Connection	Type	b_1	b_2	b_3	h_1	h_2	h_3	h_4	h_5	$\varnothing l$	t_1	t_2	t_3
4 ¹⁾	1250	1P	M12 flat terminal	3NH3 530	50	102	30	156	156	25	270	312	13	51	116	144
4a			Can only be used in bases with swivel mechanism													

¹⁾ Size 4 LV HRC fuse links are also screwed onto the base.

Fuse Systems

LV HRC Fuse Systems

LV HRC bases and accessories,
3NH3, 3NG1, 3NX

LV HRC bus-mounting bases¹⁾

Size 000/00, 160 A
1P

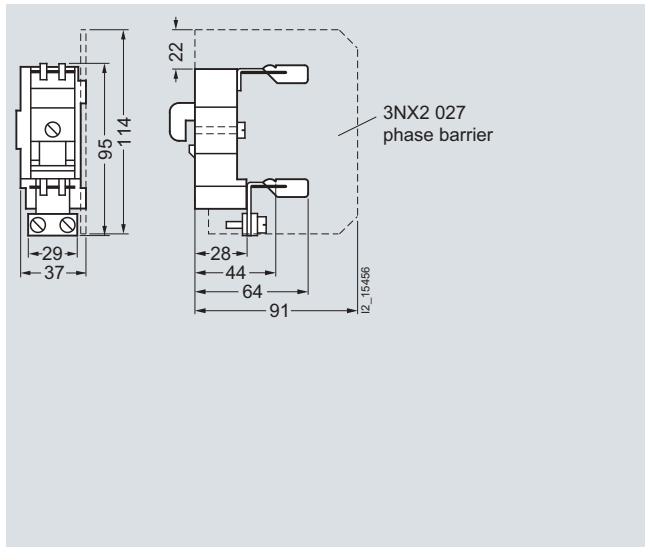

3NH3 036, 3NH3 037

LV HRC bases with tandem design

Size 000/00, 80 A
3P

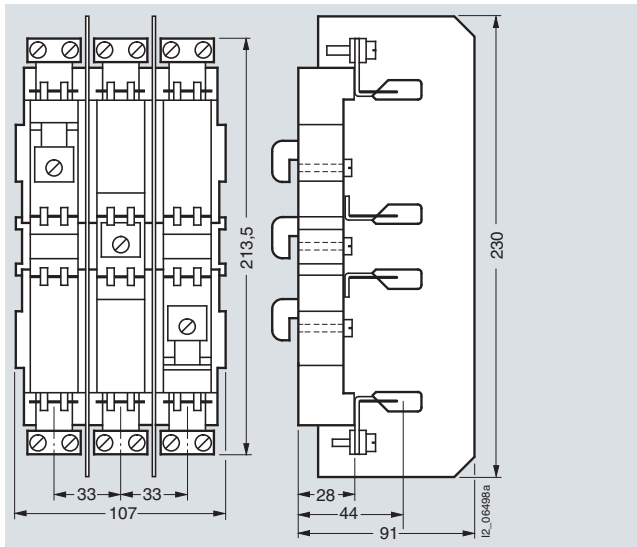

Busbar center-to-center clearance 40 mm
3NH4 037, 3NH4 045

1) LV HRC bus-mounting bases are only connected on one side using terminals, the second connection is made through the bottom of the base.

LV HRC fuse bases with swivel mechanism

Sizes 000/00, 1, 3 and 4a

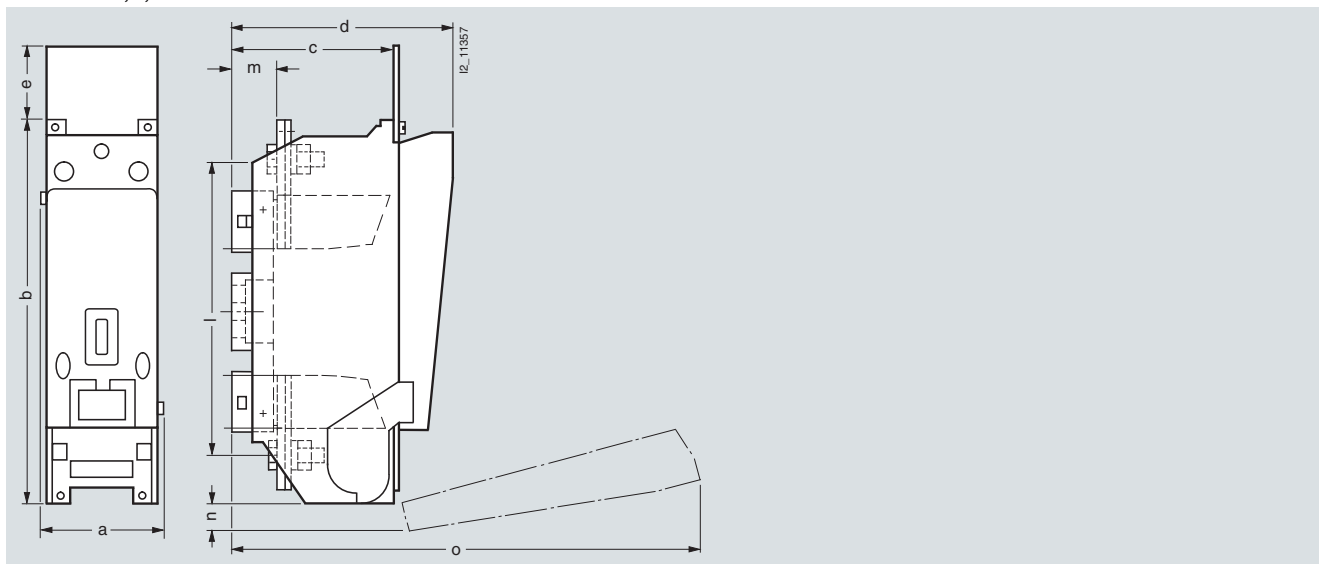

3NH7 03., 3NH7 23., 3NH7 33., 3NH7 520

Sizes	I_n A	Type	a	b	c	d	e	l	m	n	o
000/ 00	160	3NH7 030, 3NH7 031, 3NH7 032	49	149	45	88.5	22.5	120	17	18	200
1	250	3NH7 230, 3NH7 231, 3NH7 232	68	230	68	123.5	23	177	25	40	300
3	630	3NH7 330, 3NH7 331, 3NH7 332	90	270	96	153.5	15.5	220.5	30.5	35	350
4a	1250	3NH7 520	116	350	154.5	217.5	69	270	40	26	440

Fuse Systems

LV HRC Fuse Systems

LV HRC bases and accessories,
3NH3, 3NG1, 3NX

LV HRC contact covers for LV HRC fuse bases and LV HRC bus-mounting bases¹⁾

Size 000/00 to 3

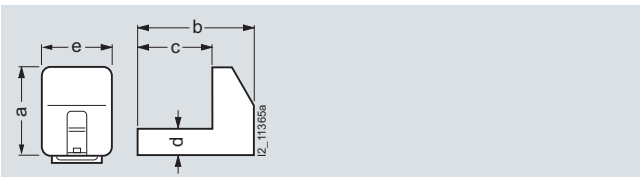

3NX3 105 to 3NX3 108, 3NX3 114

Sizes	Type	a	b	c	d	e
000/00	3NX3 105 ¹⁾	38	47.5	34	11.5	30
0	3NX3 114	51.5	47.5	34	11.5	30
1	3NX3 106	61.5	57	42.5	35	46
2	3NX3 107	74	65	51	35	46
3	3NX3 108	81.5	77.5	57.5	35	46

¹⁾ The 3NX3 105 LV HRC contact covers can be used for both LV HRC fuse bases and LV HRC bus-mounting bases.

LV HRC contact covers for LV HRC bus-mounting bases



3NX3 113 for the incoming terminal, dimensional drawing 3NX3 105, for the outgoing terminal see dimensional drawing above

3NX3 115 LV HRC protective covers, with 3NX3 116 LV HRC covers

Size 000/00, degree of protection IP2X

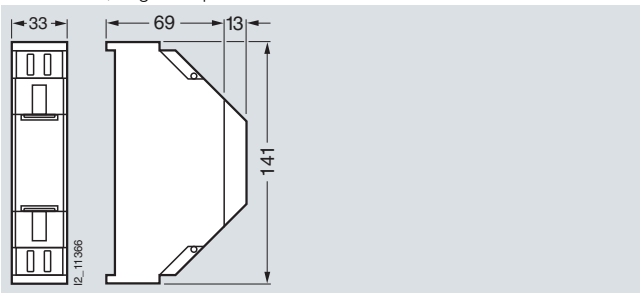

LV HRC partitions for LV HRC bus-mounting bases

Size 000/00

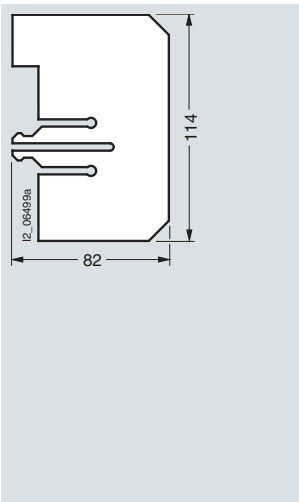

Phase barrier
3NX2 027

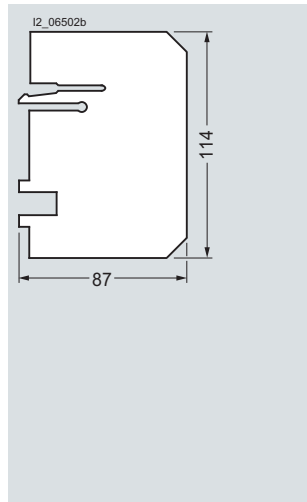

End barrier
3NX2 028

LV HRC partitions for LV HRC bases

Size 000/00

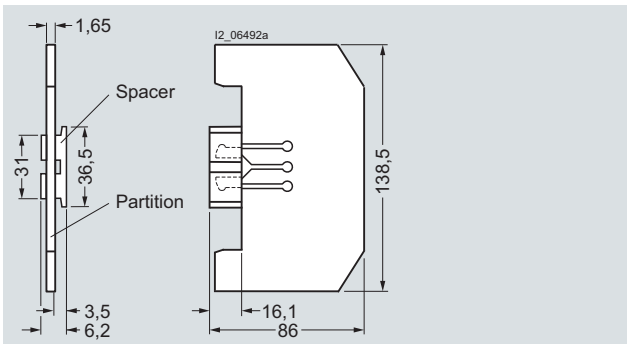

3NX3 023

Sizes 0 to 3

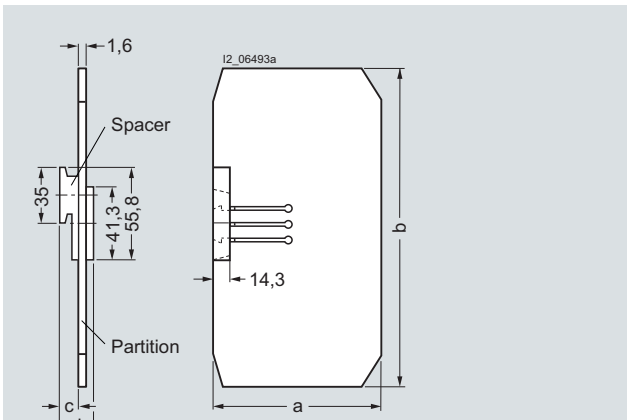

3NX2 030, 3NX2 024 to 3NX2 026

Sizes	Type	a	b	c	d
0	3NX2 030	87.6	178.5	7.7	12.3
1	3NX2 024	107.3	202.5	7.7	12.3
2	3NX2 025	115.3	227.5	14.2	25.1
3	3NX2 026	129.8	242	20.2	37.2

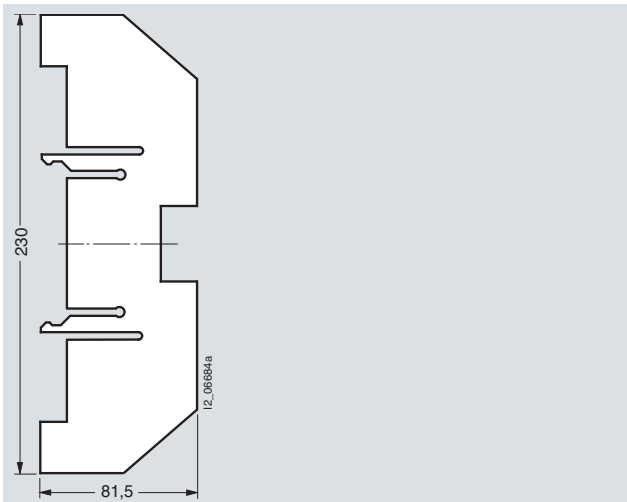

For LV HRC bus-mounting bases in tandem design
3NX2 031

Fuse Systems

LV HRC Fuse Systems

LV HRC bases and accessories,
3NH3, 3NG1, 3NX

Fuse pullers

Sizes 000 to 4

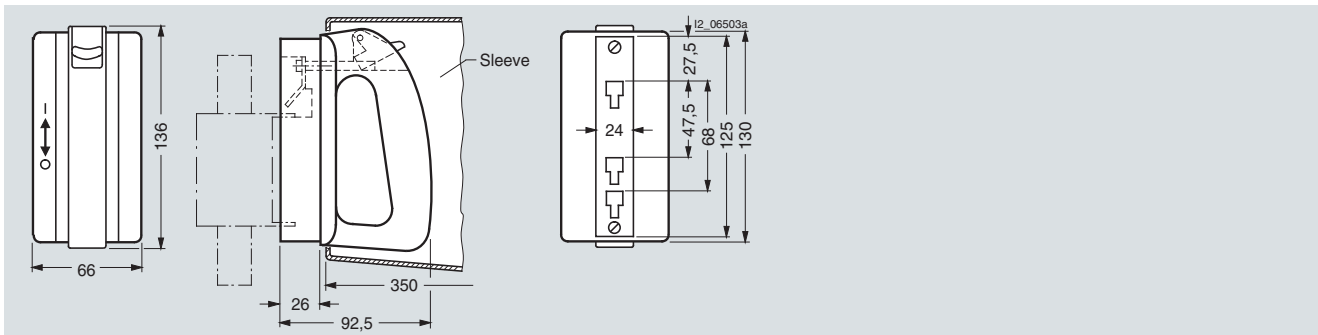

3NX1 013 (without sleeve), 3NX1 014 (with sleeve)

Isolating blades with insulated grip lugs

Size 000/00 to 3

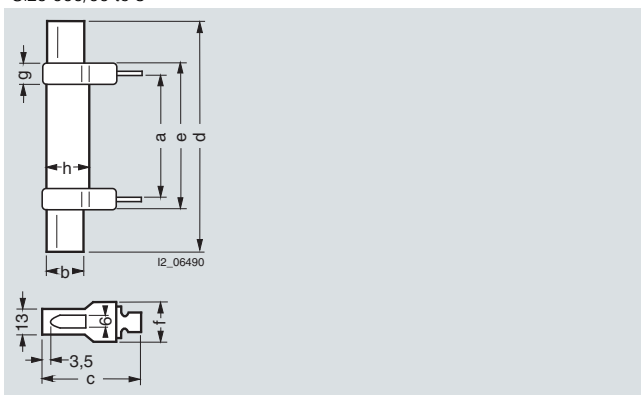

3NG1 .02

Sizes	Type	a	b	c	d	e	f	g	h
000/00	3NG1 002	44	15	48	78	54	20.5	8	19
0	3NG1 102	60.5	15	48	125	68	20.5	8	19
1	3NG1 202	61	20	53	135	72	23	9	24
2	3NG1 302	61	26	61	150	72	23	9	29
3	3NG1 402	61	32	73	150	72	23	9	36

Isolating blades with non-insulated grip lugs

Size 4

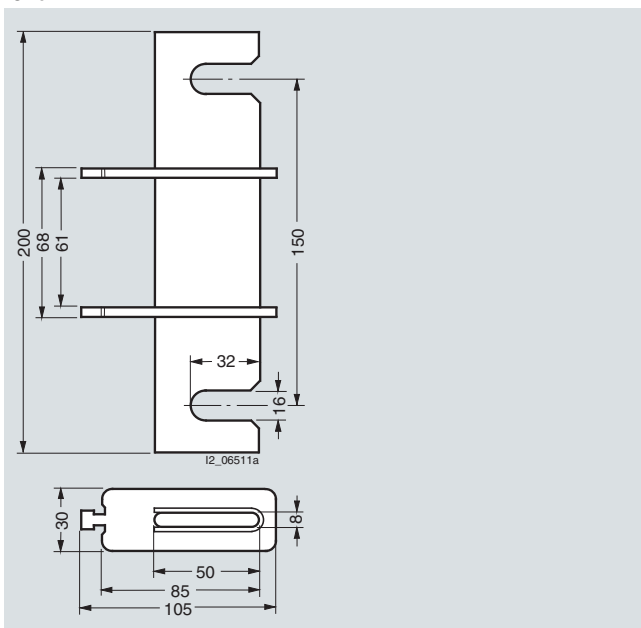

3NG1 503

Size 4a

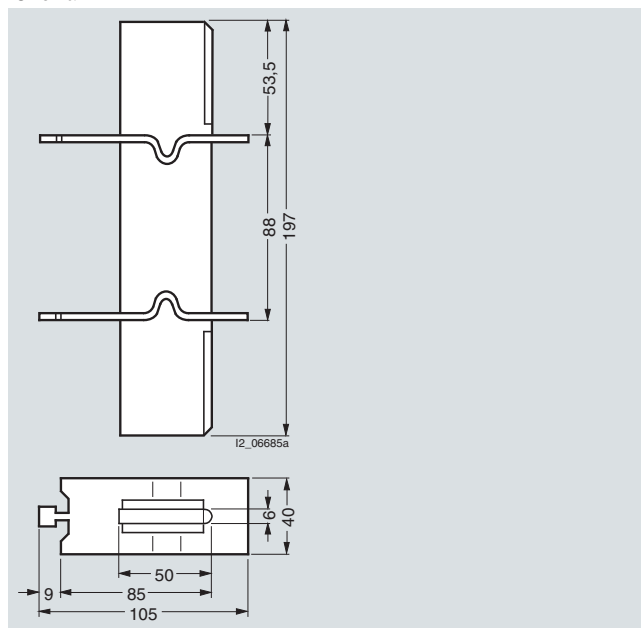

3NG1 505

More information

Space requirements when installing LV HRC fuse bases

1 LV HRC fuse base, 3P

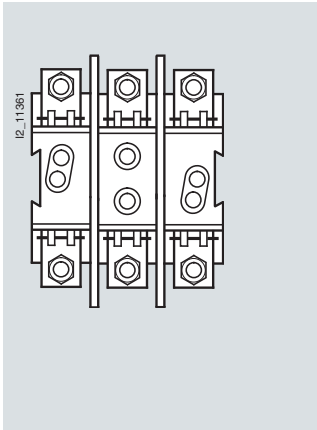

3 LV HRC fuse bases, 1P

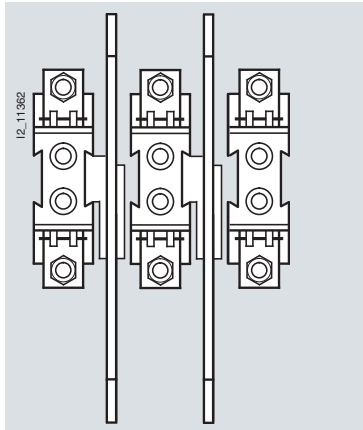

LV HRC partitions

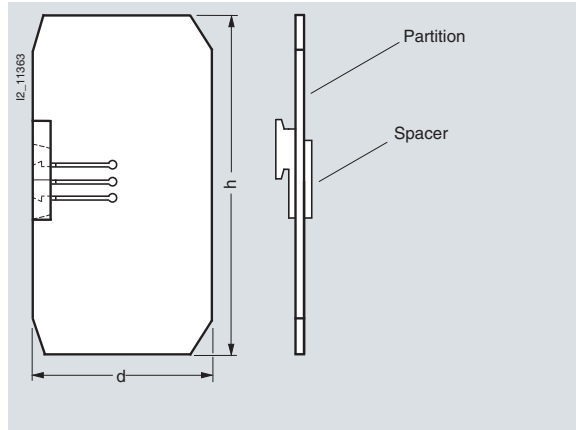

Sizes	Mounting width (mm) of LV HRC fuse bases				Distance through spacer	Mounting height (mm)	Mounting depth (mm)
	1 unit, 3P		3 units, 1P			3NX2 0.. partitions with matching bases ¹⁾	
	Bases with phase barrier, without end barrier	Bases with phase barrier and 2 end barriers	Bases with phase barrier, without end barrier	Bases with phase barrier and 2 end barriers		h	d
000/00	102	106	100	104 ²⁾	2	138	86
	LV HRC bus-mounting bases see page 54				–	114	90
0	--	--	128	142	7	178	90
1	163	177	158	172	7	202	110
2	--	--	184	224	20 ³⁾	227	118
3	--	--	208	272	32 ³⁾	242	132
4	Installation without barriers; for mounting see page 54					n/a	
4a	Can only be used in bases with swivel mechanism					n/a	

- 1) This measurement specifies the required overall mounting depth with base d and the overall mounting height h.
- 2) Placing an additional base on the barrier and plug-on part does not increase the distance, rather the bases lie flat directly on top of one another.
- 3) If the bases are installed directly on a side wall in the distribution board, one spacer part can be broken off. This would reduce the distance measurement.

Space requirements when installing LV HRC bus-mounting bases

Space requirements for 3-piece, 1-pole 3NH3 036 and 3NH3 037 LV HRC bus-mounting bases, staggered

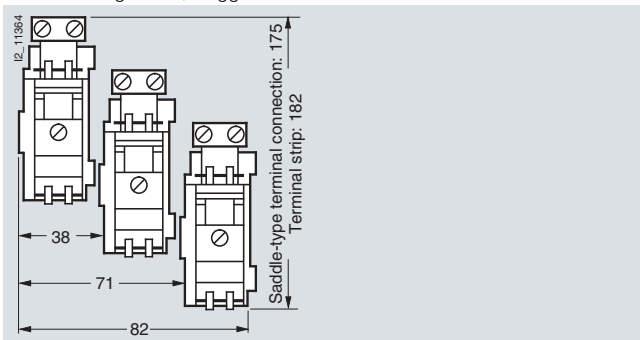

Fuse Systems

LV HRC Fuse Systems

LV HRC bases and accessories,
3NH3, 3NG1, 3NX

Characteristic curves

Series 3NA3 0

Size: 0
Operational class: gG
Rated voltage: 500 V AC/440 V DC
Rated current: 6 ... 160 A

Time/current characteristics diagram

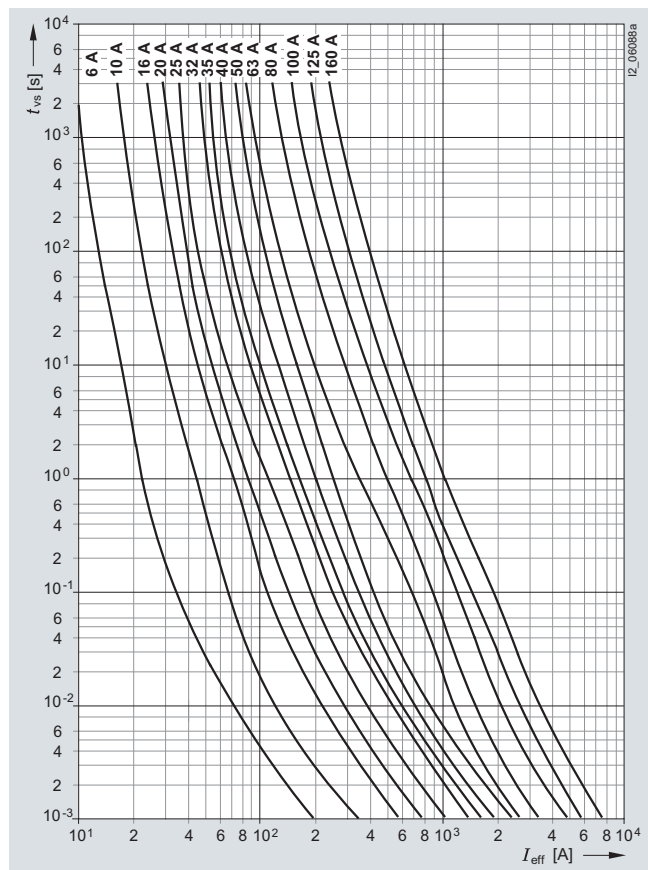

Melting I^2t values diagram

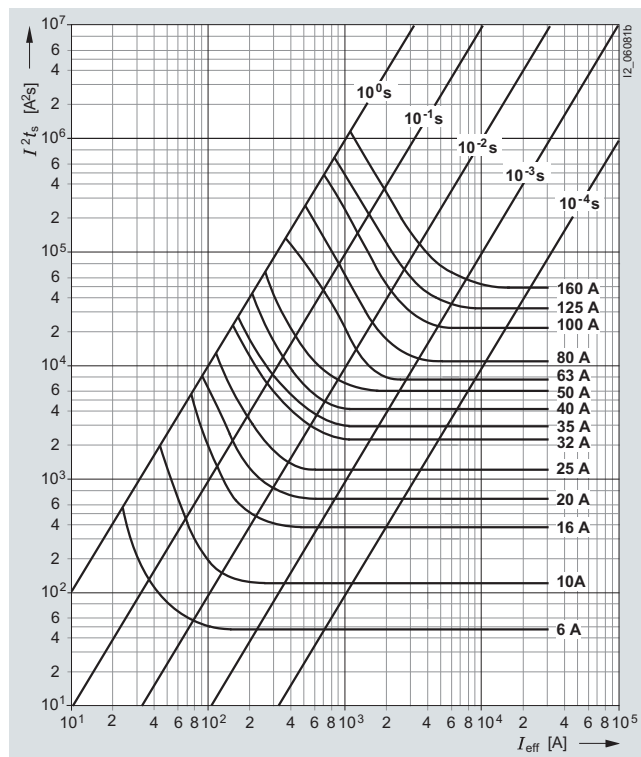

Current limitation diagram

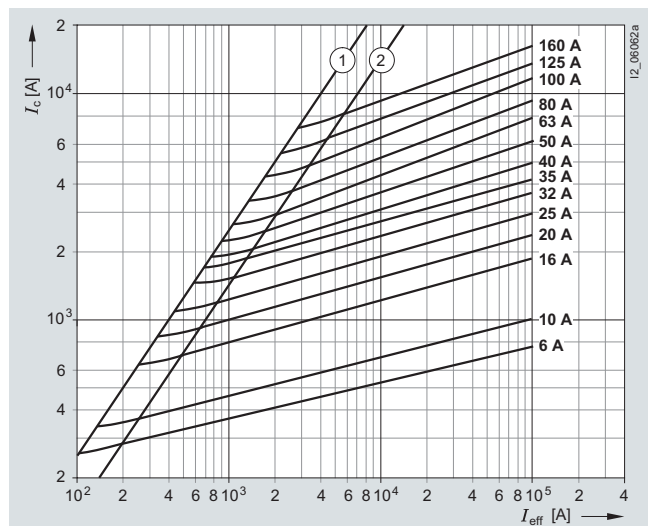

- ① Peak short-circuit current with largest DC component
- ② Peak short-circuit current without DC component

Type	I_n A	P_v W	$\Delta\theta$ K	I^2t_s 1 ms A ² s	4 ms A ² s
3NA3 001	6	1.5	6	46	50
3NA3 003	10	1	9	120	130
3NA3 005	16	1.9	11	370	420
3NA3 007	20	2.3	13	670	750
3NA3 010	25	2.7	15	1200	1380
3NA3 012	32	3	13	2200	2400
3NA3 014	35	3	17	3000	3300
3NA3 017	40	3.4	17	4000	4500
3NA3 020	50	4.5	24	6000	6800
3NA3 022	63	5.8	27	7700	9800
3NA3 024	80	7	34	12000	16000
3NA3 030	100	8.2	37	24000	30600
3NA3 032	125	10.2	38	36000	50000
3NA3 036	160	13.5	44	58000	85000

Type	I^2t_a 230 V AC A ² s	400 V AC A ² s	500 V AC A ² s
3NA3 001	80	110	150
3NA3 003	180	265	370
3NA3 005	580	750	1000
3NA3 007	1000	1370	1900
3NA3 010	1800	2340	3300
3NA3 012	3400	4550	6400
3NA3 014	4900	6750	9300
3NA3 017	6100	8700	12100
3NA3 020	9100	11600	16000
3NA3 022	14200	19000	26500
3NA3 024	23100	30700	43000
3NA3 030	40800	56200	80000
3NA3 032	70000	91300	130000
3NA3 036	120000	158000	223000

Fuse Systems

LV HRC Fuse Systems

LV HRC bases and accessories,
3NH3, 3NG1, 3NX

Series 3NA3 1, 3NA6 1, 3NA7 1

Size: 1
Operational class: gG
Rated voltage: 500 V AC/440 V DC
Rated current: 16 ... 250 A

Time/current characteristics diagram

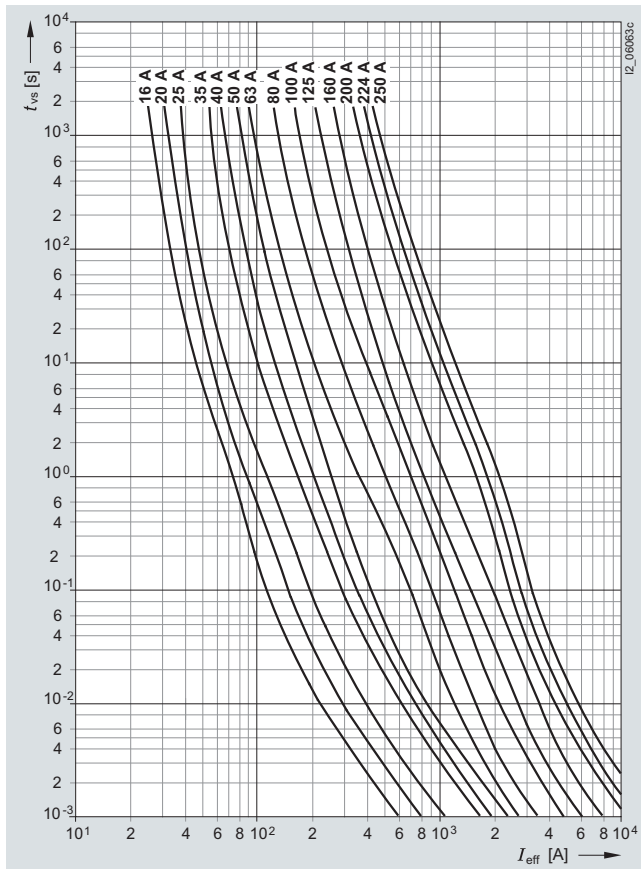

Current limitation diagram

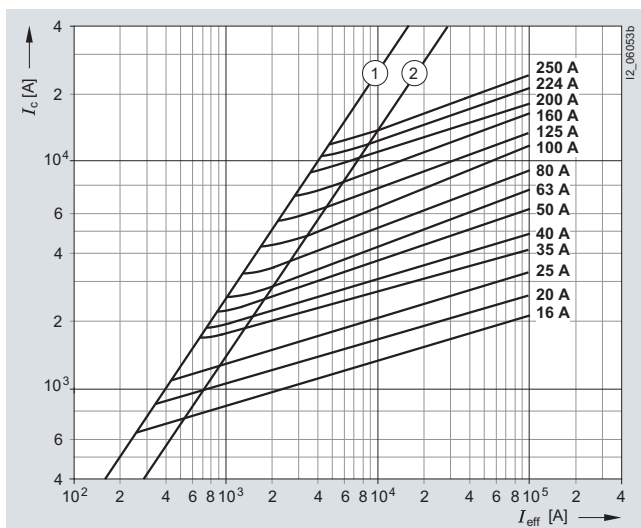

- ① Peak short-circuit current with largest DC component
- ② Peak short-circuit current without DC component

Melting I^2t values diagram

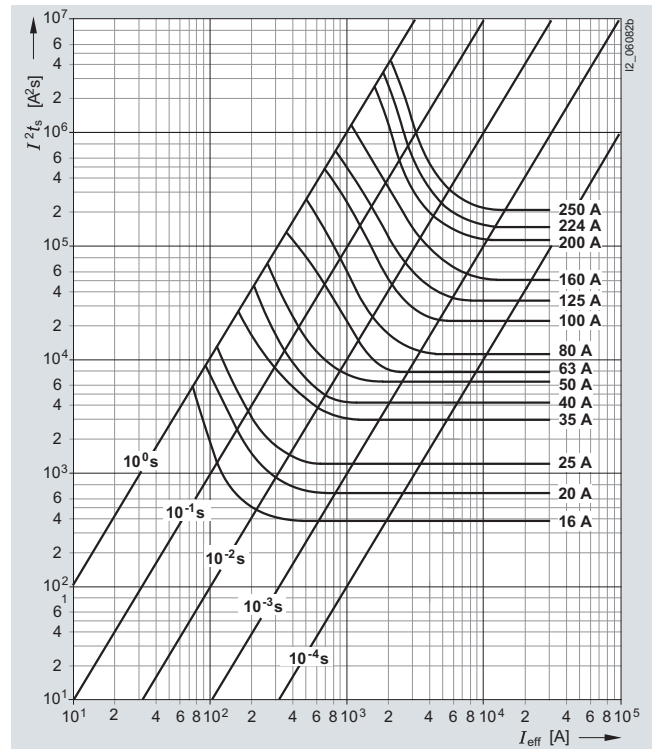

Type	I_n	P_V	$\Delta\theta$	I^2t_s	
	A	W	K	1 ms A ² s	4 ms A ² s
3NA3 105, 3NA6 105, 3NA7 105	16	2.1	8	370	420
3NA3 107, 3NA6 107, 3NA7 107	20	2.4	10	670	750
3NA3 110, 3NA6 110, 3NA7 110	25	2.8	11	1200	1380
3NA3 114, 3NA6 114, 3NA7 114	35	3.2	16	3000	3300
3NA3 117, 3NA6 117, 3NA7 117	40	3.6	16	4000	4500
3NA3 120, 3NA6 120, 3NA7 120	50	4.6	20	6000	6800
3NA3 122, 3NA6 122, 3NA7 122	63	6	21	7700	9800
3NA3 124, 3NA6 124, 3NA7 124	80	7.5	29	12000	16000
3NA3 130, 3NA6 130, 3NA7 130	100	8.9	30	24000	30600
3NA3 132, 3NA6 132, 3NA7 132	125	10.7	31	36000	50000
3NA3 136, 3NA6 136, 3NA7 136	160	13.9	34	58000	85000
3NA3 140, 3NA6 140, 3NA7 140	200	15	36	115000	135000
3NA3 142, 3NA6 142, 3NA7 142	224	16.1	37	145000	170000
3NA3 144, 3NA6 144, 3NA7 144	250	17.3	39	205000	230000

Type	I^2t_a		
	230 V AC A ² s	400 V AC A ² s	500 V AC A ² s
3NA3 105, 3NA6 105, 3NA7 105	580	750	1000
3NA3 107, 3NA6 107, 3NA7 107	1000	1370	1900
3NA3 110, 3NA6 110, 3NA7 110	1800	2340	3300
3NA3 114, 3NA6 114, 3NA7 114	4900	6750	9300
3NA3 117, 3NA6 117, 3NA7 117	6100	8700	12100
3NA3 120, 3NA6 120, 3NA7 120	9100	11600	16000
3NA3 122, 3NA6 122, 3NA7 122	14200	19000	26500
3NA3 124, 3NA6 124, 3NA7 124	23100	30700	43000
3NA3 130, 3NA6 130, 3NA7 130	40800	56200	80000
3NA3 132, 3NA6 132, 3NA7 132	70000	91300	130000
3NA3 136, 3NA6 136, 3NA7 136	120000	158000	223000
3NA3 140, 3NA6 140, 3NA7 140	218000	285000	400000
3NA3 142, 3NA6 142, 3NA7 142	299000	392000	550000
3NA3 144, 3NA6 144, 3NA7 144	420000	551000	780000

Fuse Systems

LV HRC Fuse Systems

LV HRC bases and accessories,
3NH3, 3NG1, 3NX

Series 3NA3 1..-6, 3NA6 1..-6, 3NA7 1..-6

Size: 1
Operational class: gG
Rated voltage: 690 V AC/440 V DC
Rated current: 50 ... 200 A

Time/current characteristics diagram

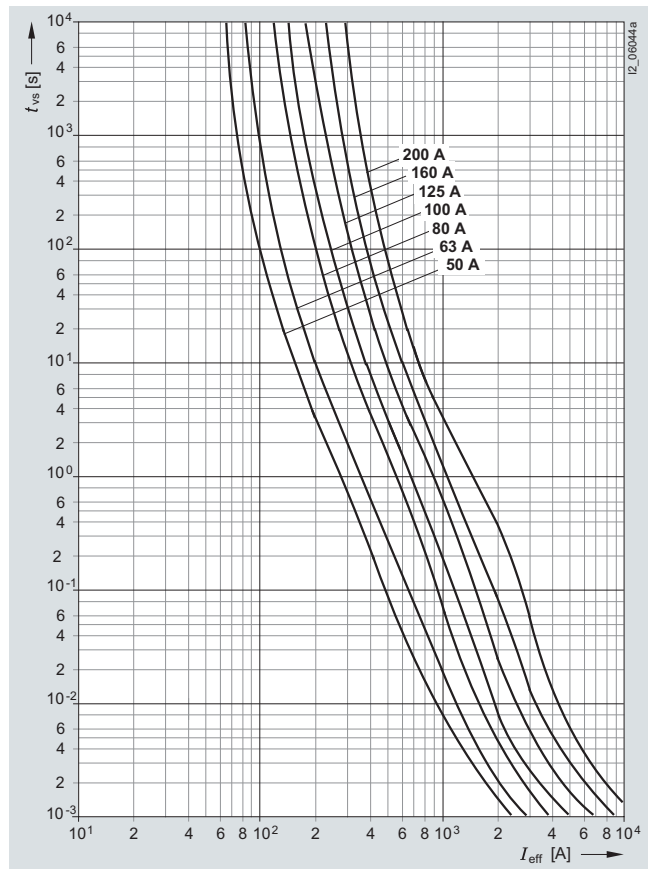

Melting I^2t_s values diagram

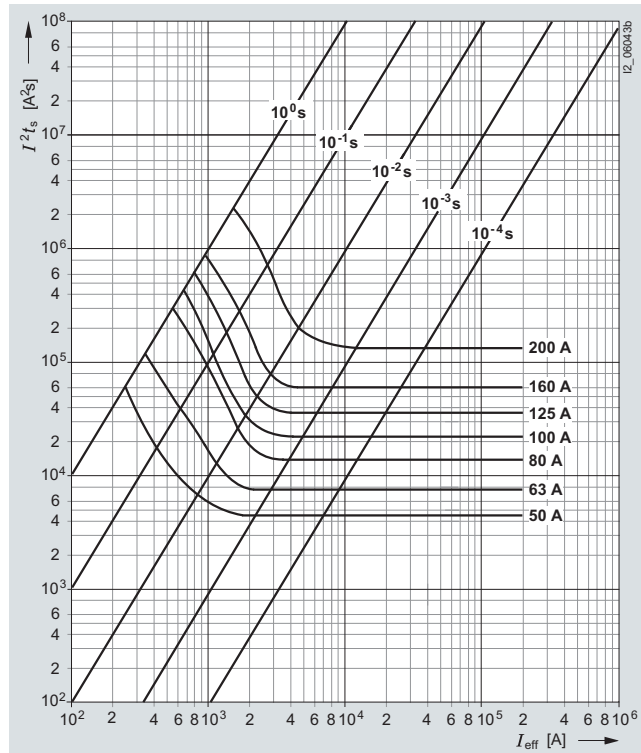

Current limitation diagram

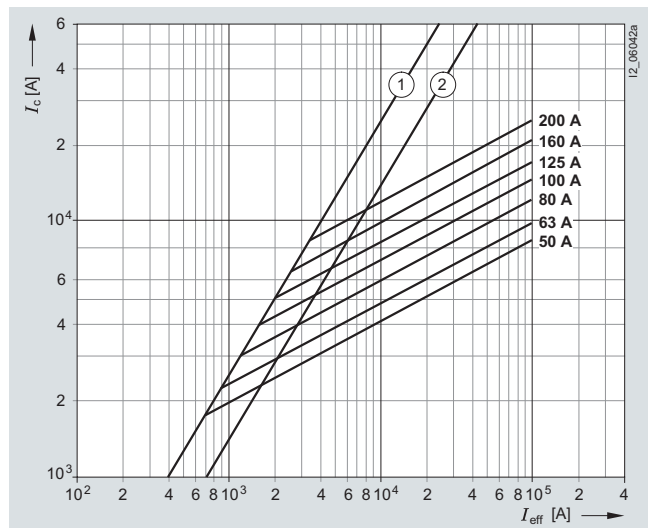

- ① Peak short-circuit current with largest DC component
- ② Peak short-circuit current without DC component

Type	I_n	P_v	$\Delta\theta$	I^2t_s	
	A	W	K	1 ms A ² s	4 ms A ² s
3NA3 120-6, 3NA6 120-6, 3NA7 120-6	50	6.7	21	440	7400
3NA3 122-6, 3NA6 122-6, 3NA7 122-6	63	7.6	22	7600	10100
3NA3 124-6, 3NA6 124-6, 3NA7 124-6	80	6.7	22	13500	17000
3NA3 130-6, 3NA6 130-6, 3NA7 130-6	100	8.7	28	21200	30500
3NA3 132-6, 3NA6 132-6, 3NA7 132-6	125	10.5	29	36000	50000
3NA3 136-6, 3NA6 136-6, 3NA7 136-6	160	13.8	33	58000	85000
3NA3 140-6, 3NA6 140-6, 3NA7 140-6	200	16.6	35	132000	144000

Type	I^2t_a		
	230 V AC A ² s	400 V AC A ² s	690 V AC A ² s
3NA3 120-6, 3NA6 120-6, 3NA7 120-6	9100	11200	1900
3NA3 122-6, 3NA6 122-6, 3NA7 122-6	13600	17000	24000
3NA3 124-6, 3NA6 124-6, 3NA7 124-6	24300	32000	55000
3NA3 130-6, 3NA6 130-6, 3NA7 130-6	42400	52000	75000
3NA3 132-6, 3NA6 132-6, 3NA7 132-6	69500	82200	130000
3NA3 136-6, 3NA6 136-6, 3NA7 136-6	120000	155000	223000
3NA3 140-6, 3NA6 140-6, 3NA7 140-6	211000	240000	360000

Fuse Systems

LV HRC Fuse Systems

LV HRC bases and accessories,
3NH3, 3NG1, 3NX

Series 3NA3 2, 3NA6 2, 3NA7 2

Size: 2
Operational class: gG
Rated voltage: 500 V AC/440 V DC
Rated current: 35 ... 400 A

Time/current characteristics diagram

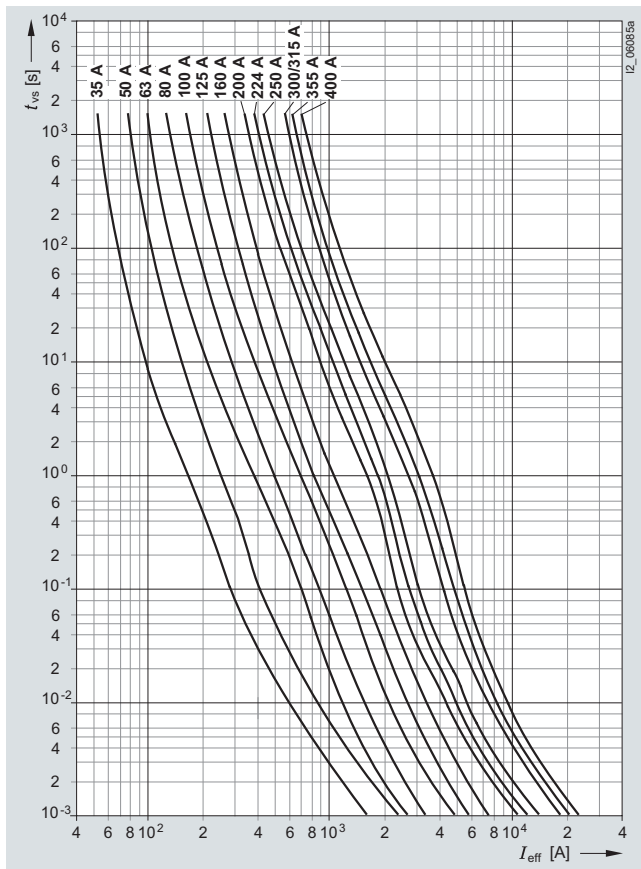

Current limitation diagram

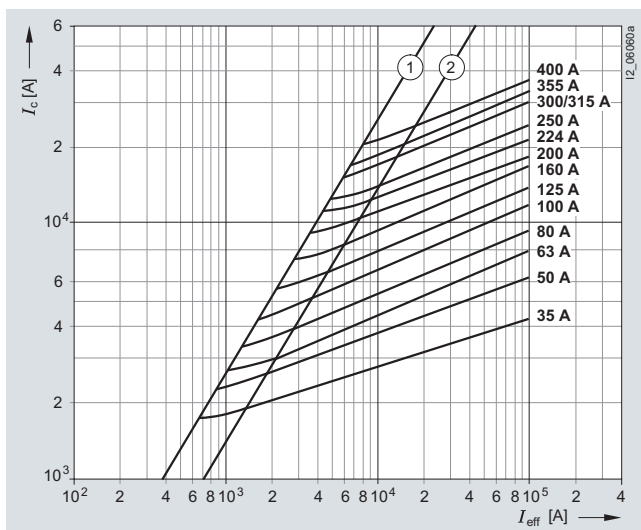

- ① Peak short-circuit current with largest DC component
- ② Peak short-circuit current without DC component

Melting I^2t values diagram

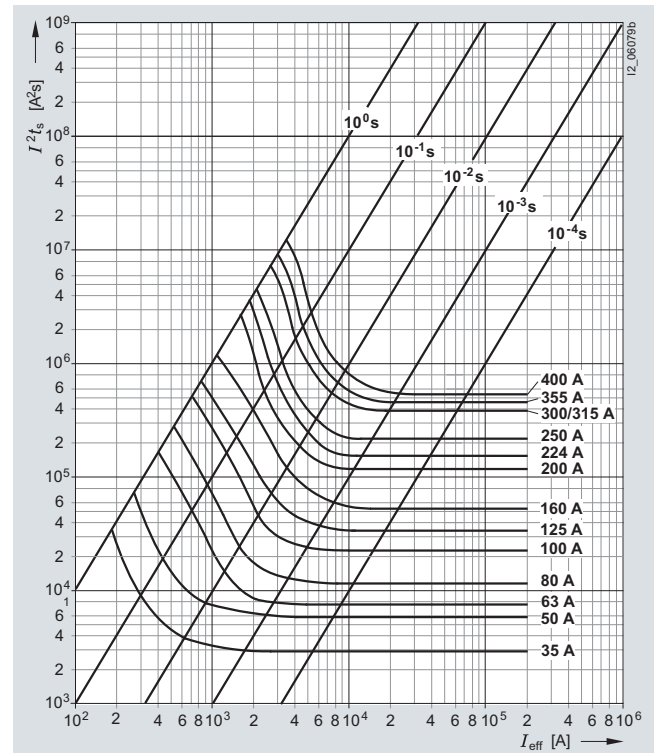

Type	I_n	P_v	$\Delta\theta$	I^2t_s	
	A	W	K	1 ms A ² s	4 ms A ² s
3NA3 214, 3NA6 214, 3NA7 214	35	3.2	12	3000	3300
3NA3 220, 3NA6 220, 3NA7 220	50	4.7	16	6000	6800
3NA3 222, 3NA6 222, 3NA7 222	63	5.9	16	7700	9800
3NA3 224, 3NA6 224, 3NA7 224	80	6.8	21	12000	16000
3NA3 230, 3NA6 230, 3NA7 230	100	7.4	22	24000	30600
3NA3 232, 3NA6 232, 3NA7 232	125	9.8	27	36000	50000
3NA3 236, 3NA6 236, 3NA7 236	160	12.6	34	58000	85000
3NA3 240, 3NA6 240, 3NA7 240	200	14.9	33	115000	135000
3NA3 242, 3NA6 242, 3NA7 242	224	15.4	31	145000	170000
3NA3 244, 3NA6 244, 3NA7 244	250	17.9	38	205000	230000
3NA3 250, 3NA6 250	300	19.4	34	361000	433000
3NA3 252, 3NA6 252, 3NA7 252	315	21.4	35	361000	433000
3NA3 254, 3NA6 254	355	26.0	49	441000	538000
3NA3 260, 3NA6 260, 3NA7 260	400	27.5	52	529000	676000

Type	I^2t_a		
	230 V AC A ² s	400 V AC A ² s	500 V AC A ² s
3NA3 214, 3NA6 214, 3NA7 214	4900	6750	9300
3NA3 220, 3NA6 220, 3NA7 220	9100	11600	16000
3NA3 222, 3NA6 222, 3NA7 222	14200	19000	26500
3NA3 224, 3NA6 224, 3NA7 224	23100	30700	43000
3NA3 230, 3NA6 230, 3NA7 230	40800	56200	80000
3NA3 232, 3NA6 232, 3NA7 232	70000	91300	130000
3NA3 236, 3NA6 236, 3NA7 236	120000	158000	223000
3NA3 240, 3NA6 240, 3NA7 240	218000	285000	400000
3NA3 242, 3NA6 242, 3NA7 242	299000	392000	550000
3NA3 244, 3NA6 244, 3NA7 244	420000	551000	780000
3NA3 250, 3NA6 250	670000	901000	1275000
3NA3 252, 3NA6 252, 3NA7 252	670000	901000	1275000
3NA3 254, 3NA6 254	800000	1060000	1500000
3NA3 260, 3NA6 260, 3NA7 260	1155000	1515000	2150000

Fuse Systems

LV HRC Fuse Systems

LV HRC bases and accessories,
3NH3, 3NG1, 3NX

Series 3NA3 2..-6, 3NA6 2..-6, 3NA7 2..-6

Size: 2
Operational class: gG
Rated voltage: 690 V AC/440 V DC
Rated current: 80 ... 315 A

Time/current characteristics diagram

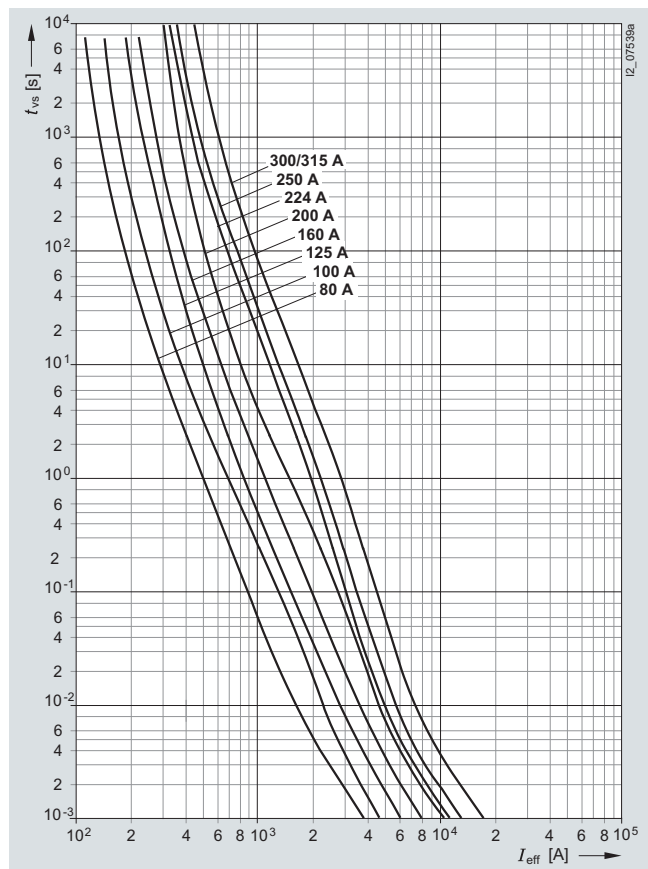

Melting I^2t values diagram

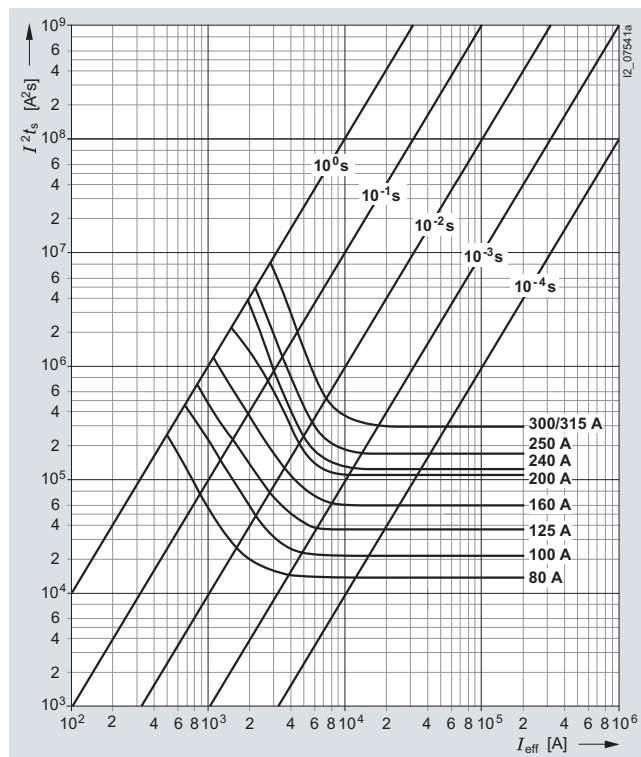

Current limitation diagram

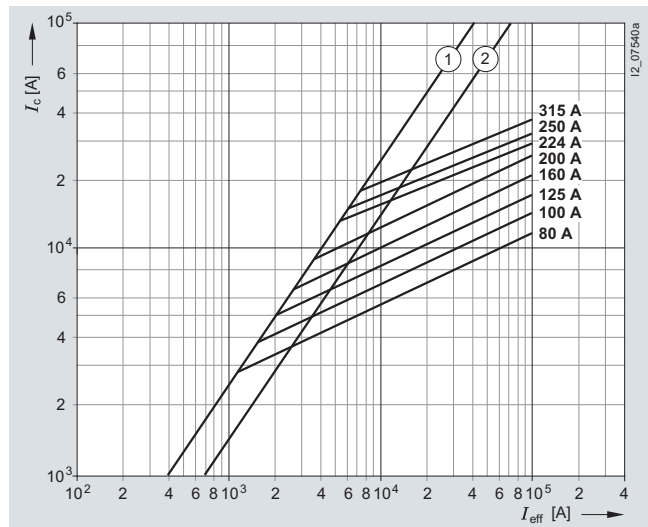

- ① Peak short-circuit current with largest DC component
- ② Peak short-circuit current without DC component

Type	I_n	P_v	$\Delta\theta$	I^2t_s	
	A	W	K	1 ms A ² s	4 ms A ² s
3NA3 224-6, 3NA6 224-6, 3NA7 224-6	80	6.6	22	13500	17000
3NA3 230-6, 3NA6 230-6, 3NA7 230-6	100	8.5	26	21200	30500
3NA3 232-6, 3NA6 232-6, 3NA7 232-6	125	9.8	29	36000	50000
3NA3 236-6, 3NA6 236-6, 3NA7 236-6	160	13.3	31	58000	85000
3NA3 240-6, 3NA6 240-6, 3NA7 240-6	200	16.1	33	132000	144000
3NA3 242-6, 3NA6 242-6, 3NA7 242-6	224	19.9	38	125000	162000
3NA3 244-6, 3NA6 244-6, 3NA7 244-6	250	23	44	180000	215000
3NA3 250-6, 3NA6 250-6, 3NA7 250-6	300	25.6	38	300000	380000
3NA3 252-6, 3NA6 252-6, 3NA7 252-6	315	28.2	42	300000	380000

Type	I^2t_a		
	230 V AC A ² s	400 V AC A ² s	690 V AC A ² s
3NA3 224-6, 3NA6 224-6, 3NA7 224-6	24300	32000	55000
3NA3 230-6, 3NA6 230-6, 3NA7 230-6	42400	52000	75000
3NA3 232-6, 3NA6 232-6, 3NA7 232-6	69500	82200	130000
3NA3 236-6, 3NA6 236-6, 3NA7 236-6	120000	155000	223000
3NA3 240-6, 3NA6 240-6, 3NA7 240-6	211000	240000	360000
3NA3 242-6, 3NA6 242-6, 3NA7 242-6	300000	300000	450000
3NA3 244-6, 3NA6 244-6, 3NA7 244-6	453000	350000	525000
3NA3 250-6, 3NA6 250-6, 3NA7 250-6	480000	625000	940000
3NA3 252-6, 3NA6 252-6, 3NA7 252-6	480000	625000	940000

Fuse Systems

LV HRC Fuse Systems

LV HRC bases and accessories,
3NH3, 3NG1, 3NX

Series 3NA3 3

Size: 3
Operational class: gG
Rated voltage: 500 V AC/440 V DC
Rated current: 200 ... 630 A

Time/current characteristics diagram

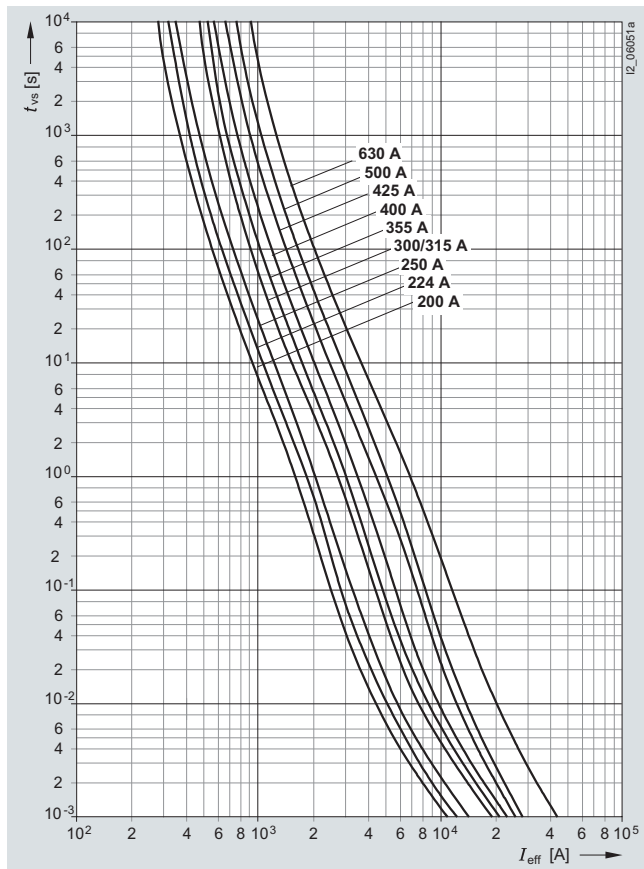

Current limitation diagram

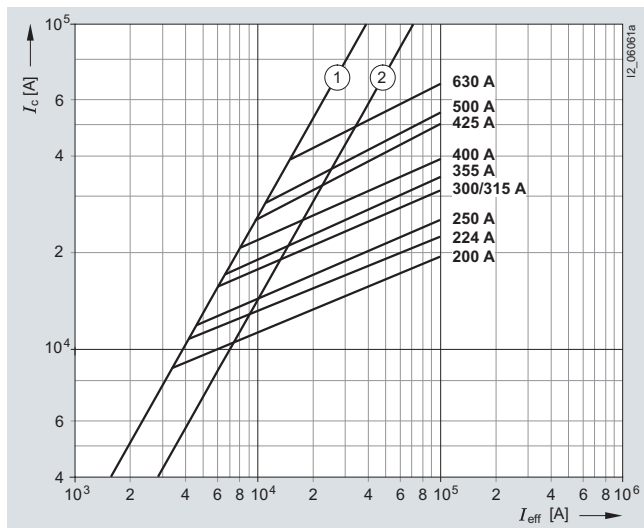

- ① Peak short-circuit current with largest DC component
- ② Peak short-circuit current without DC component

Melting I^2t values diagram

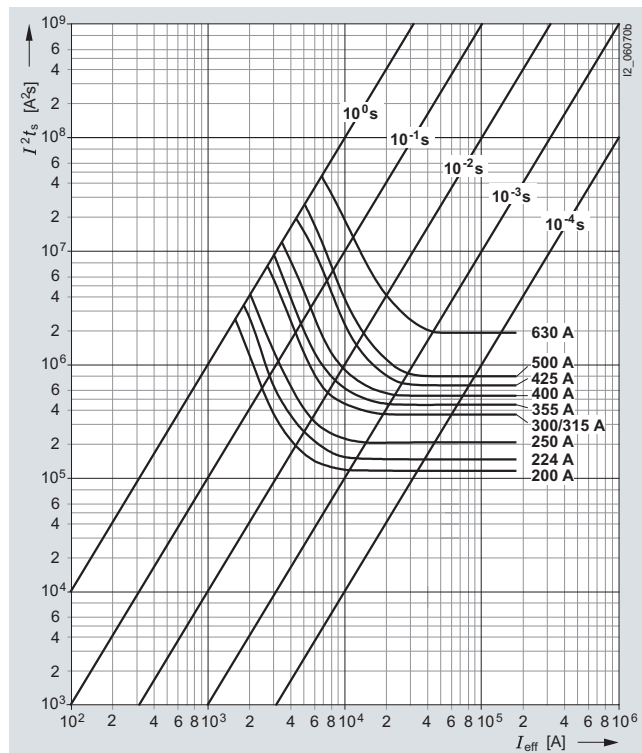

Type	I_n	P_v	$\Delta\theta$	I^2t_s	
	A	W	K	1 ms A ² s	4 ms A ² s
3NA3 340	200	14.9	32	115000	135000
3NA3 342	224	15.4	31	145000	170000
3NA3 344	250	17.9	36	205000	230000
3NA3 350	300	19.4	19	361000	433000
3NA3 352	315	21.4	22	361000	433000
3NA3 354	355	26.0	26	441000	538000
3NA3 360	400	27.5	28	529000	676000
3NA3 362	425	26.5	34	650000	970000
3NA3 365	500	36.5	41	785000	1270000
3NA3 372	630	44.0	50	1900000	2700000

Type	I^2t_a		
	230 V AC A ² s	400 V AC A ² s	500 V AC A ² s
3NA3 340	218000	285000	400000
3NA3 342	299000	392000	550000
3NA3 344	420000	551000	780000
3NA3 350	670000	901000	1275000
3NA3 352	670000	901000	1275000
3NA3 354	800000	1060000	1500000
3NA3 360	1155000	1515000	2150000
3NA3 362	1515000	1856000	2270000
3NA3 365	1915000	2260000	2700000
3NA3 372	3630000	4340000	5400000

Fuse Systems

LV HRC Fuse Systems

LV HRC bases and accessories,
3NH3, 3NG1, 3NX

Series 3NA3 3...-6

Size: 3
Operational class: gG
Rated voltage: 690 V AC/440 V DC
Rated current: 250 ... 500 A

Time/current characteristics diagram

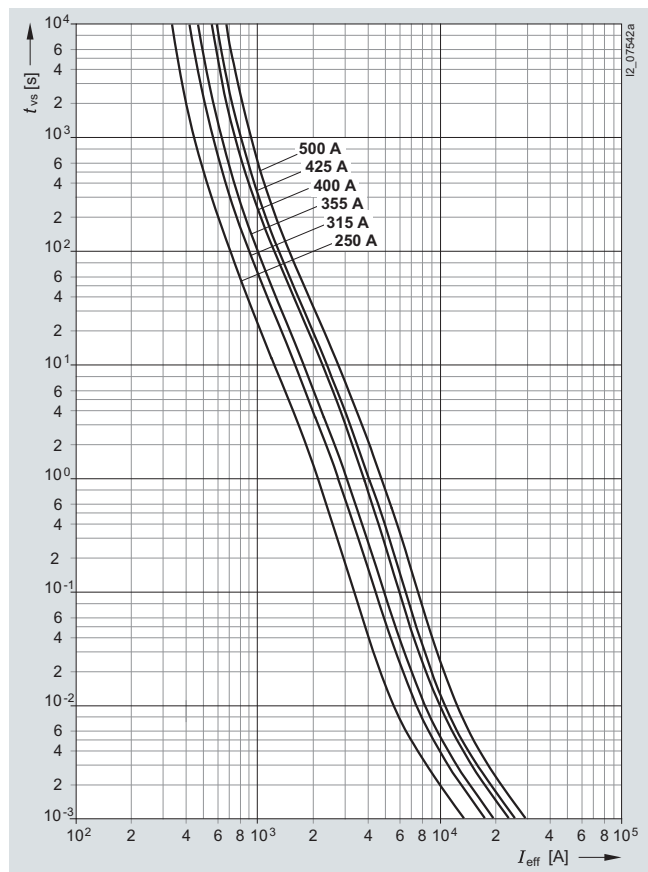

Melting I^2t values diagram

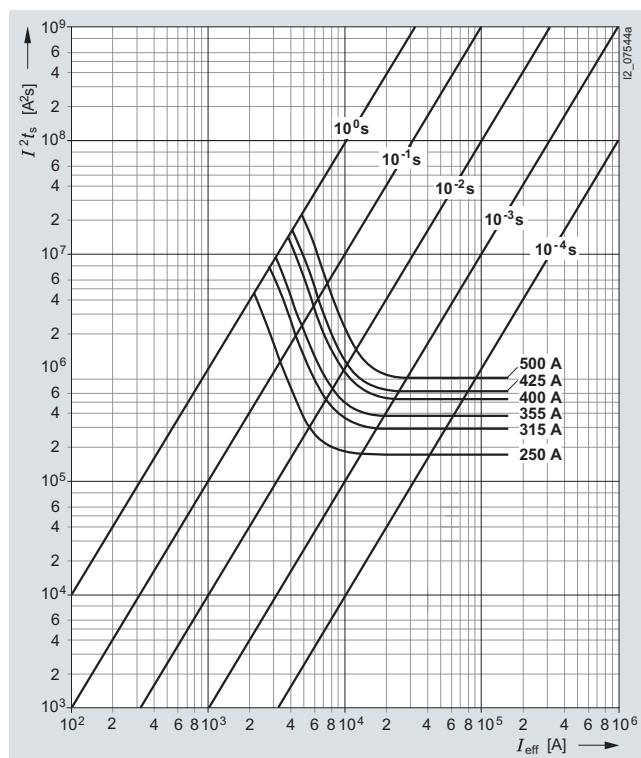

Current limitation diagram

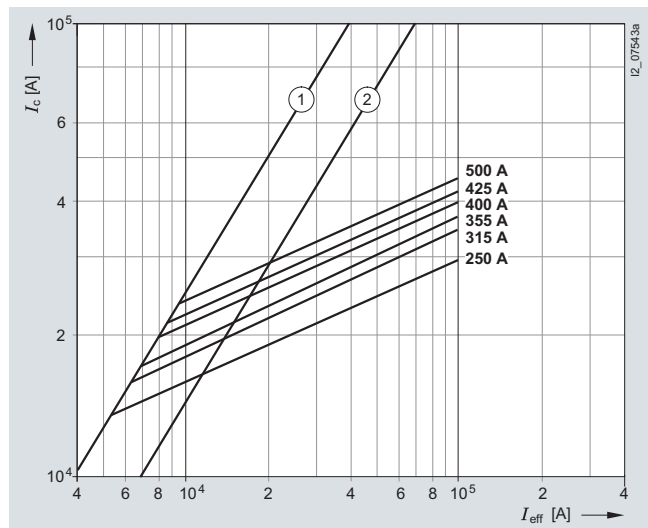

- ① Peak short-circuit current with largest DC component
- ② Peak short-circuit current without DC component

Type	I_n	P_v	$\Delta\theta$	I^2t_s	
	A	W	K	1 ms A ² s	4 ms A ² s
3NA3 344-6	250	23	44	180000	215000
3NA3 352-6	315	28.2	42	300000	380000
3NA3 354-6	355	32.5	40	380000	470000
3NA3 360-6	400	33.2	42	540000	675000
3NA3 362-6	425	35.3	44	625000	765000
3NA3 365-6	500	43.5	52	810000	1000000

Type	I^2t_a		
	230 V AC A ² s	400 V AC A ² s	690 V AC A ² s
3NA3 344-6	453000	350000	525000
3NA3 352-6	480000	625000	940000
3NA3 354-6	585000	760000	1150000
3NA3 360-6	847000	1100000	1650000
3NA3 362-6	925000	1200000	1800000
3NA3 365-6	1300000	1700000	2500000

Fuse Systems

LV HRC Fuse Systems

LV HRC bases and accessories,
3NH3, 3NG1, 3NX

Series 3NA3 4

Size: 4 (IEC design)
Operational class: gG
Rated voltage: 500 V AC/440 V DC
Rated current: 630 ... 1250 A

Time/current characteristics diagram

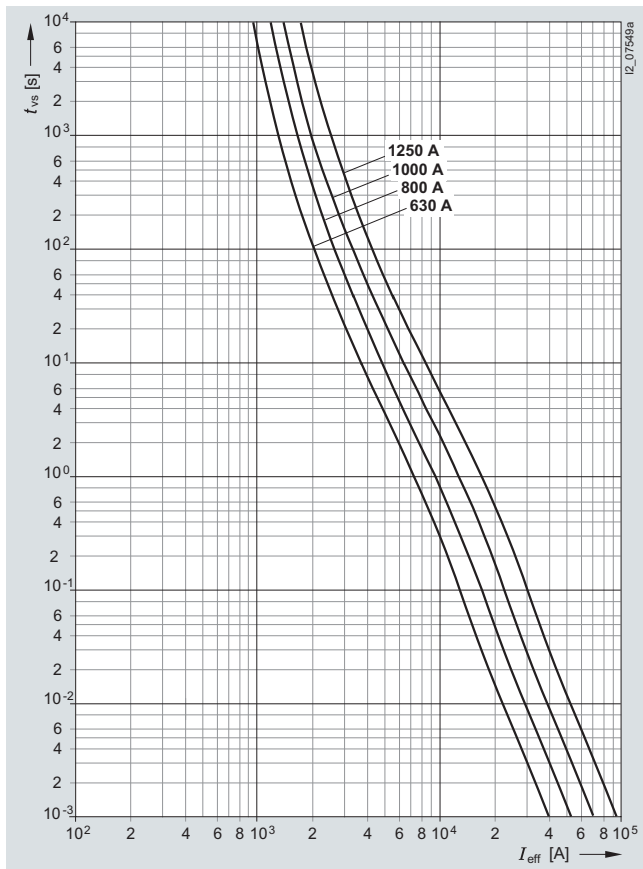

Current limitation diagram

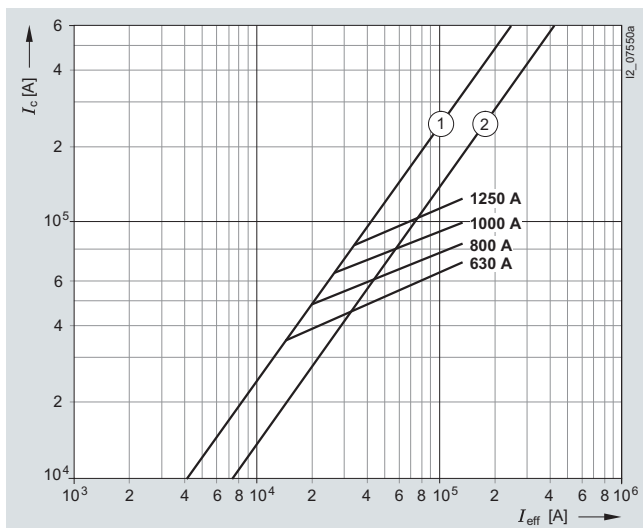

- ① Peak short-circuit current with largest DC component
- ② Peak short-circuit current without DC component

Melting I^2t values diagram

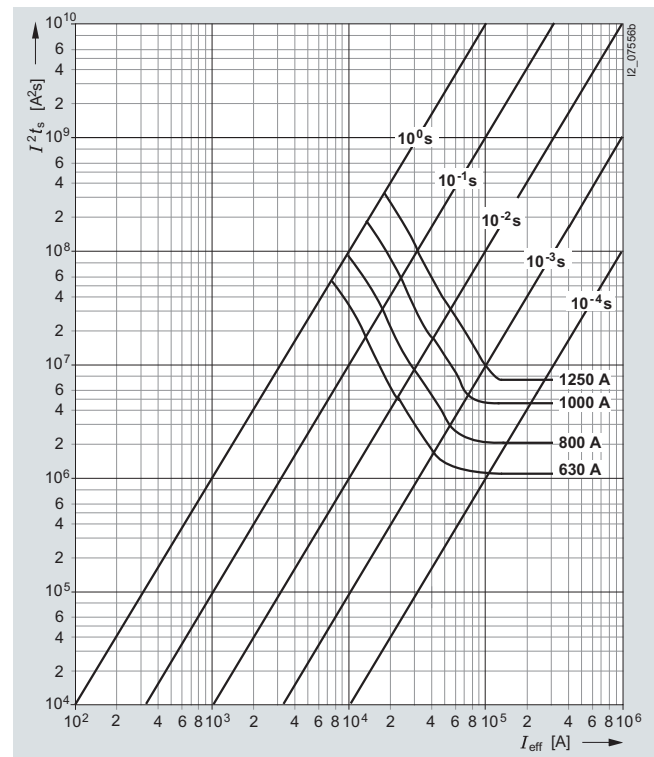

Type	I_n	P_v	$\Delta\vartheta$	I^2t_s	
	A	W	K	1 ms A ² s	4 ms A ² s
3NA3 472	630	47	37	1900000	2700000
3NA3 475	800	59	43	3480000	5620000
3NA3 480	1000	74	56	7920000	10400000
3NA3 482	1250	99	65	11880000	18200000

Type	I^2t_a	400 V AC	500 V AC
	A ² s	A ² s	A ² s
3NA3 472	3630000	4340000	5400000
3NA3 475	7210000	8510000	10400000
3NA3 480	13600000	16200000	19000000
3NA3 482	23900000	29100000	34800000

Fuse Systems

LV HRC Fuse Systems

LV HRC bases and accessories,
3NH3, 3NG1, 3NX

Series 3NA3 6

Size: 4a
Operational class: gG
Rated voltage: 500 V AC/440 V DC
Rated current: 500 ... 1250 A

Time/current characteristics diagram

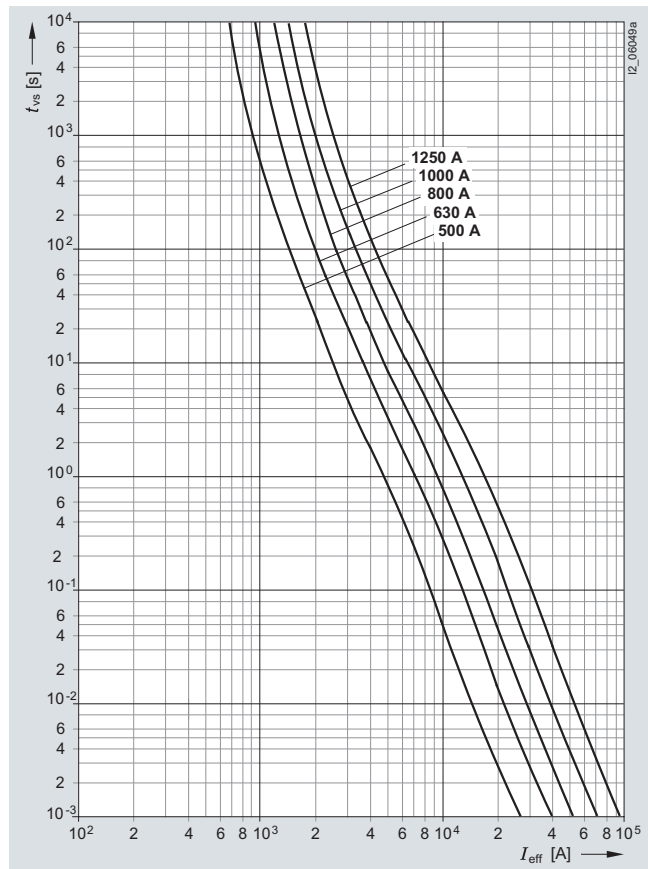

Melting I²t values diagram

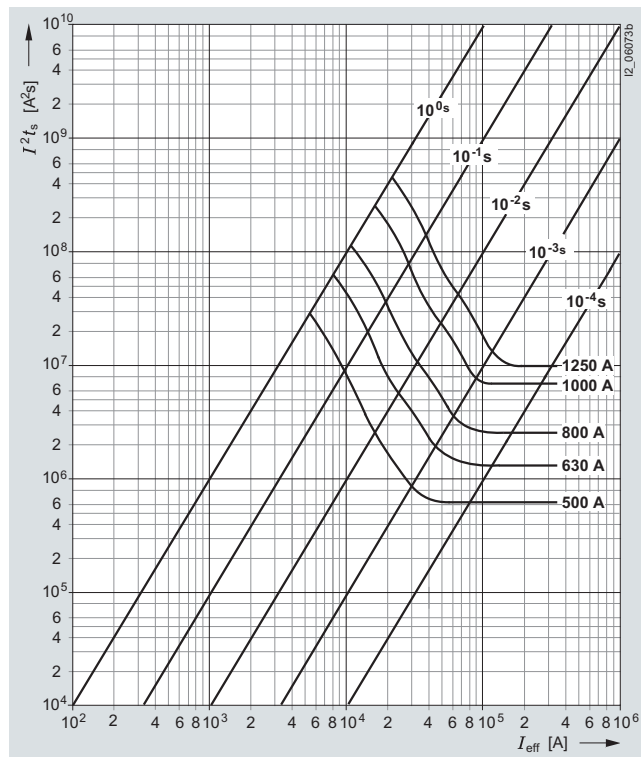

Current limitation diagram

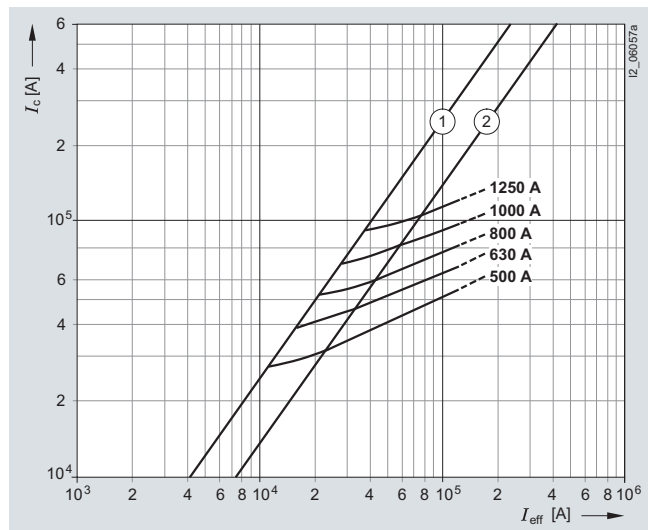

- ① Peak short-circuit current with largest DC component
- ② Peak short-circuit current without DC component

Type	I_n	P_v	$\Delta\theta$	I^2t_s	
	A	W	K	1 ms A ² s	4 ms A ² s
3NA3 665	500	43	30	785000	1270000
3NA3 672	630	47	37	1900000	2700000
3NA3 675	800	59	43	3480000	5620000
3NA3 680	1000	74	56	7920000	10400000
3NA3 682	1250	99	65	11880000	18200000

Type	I^2t_a		
	230 V AC A ² s	400 V AC A ² s	500 V AC A ² s
3NA3 665	1915000	2260000	2700000
3NA3 672	3630000	4340000	5400000
3NA3 675	7210000	8510000	10400000
3NA3 680	13600000	16200000	19000000
3NA3 682	23900000	29100000	34800000

Fuse Systems

LV HRC Fuse Systems

LV HRC bases and accessories,
3NH3, 3NG1, 3NX

Series 3NA3 8, 3NA6 8, 3NA7 8

Size: 000, 00
Operational class: gG
Rated voltage: 500 V AC/250 V DC
Rated current: 2 ... 160 A

Time/current characteristics diagram

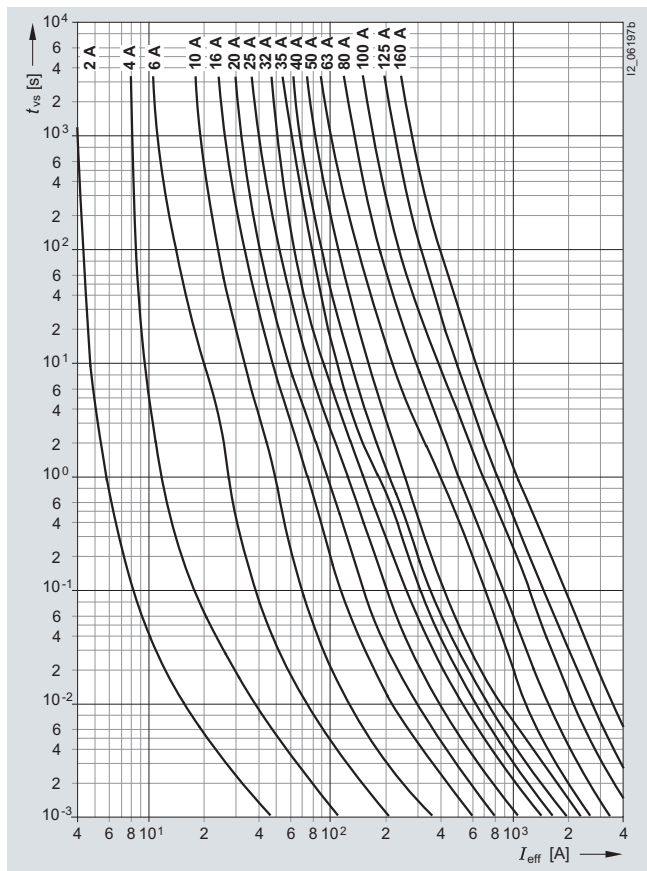

Melting I^2t values diagram

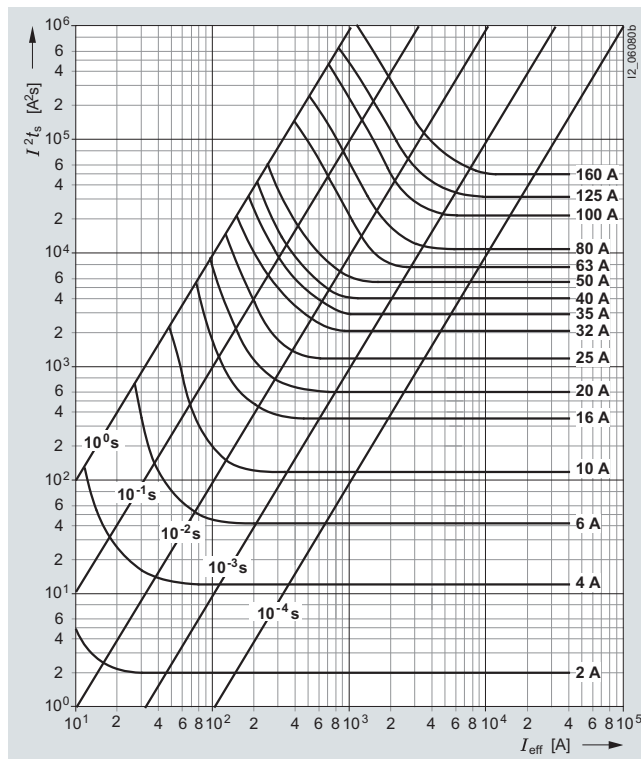
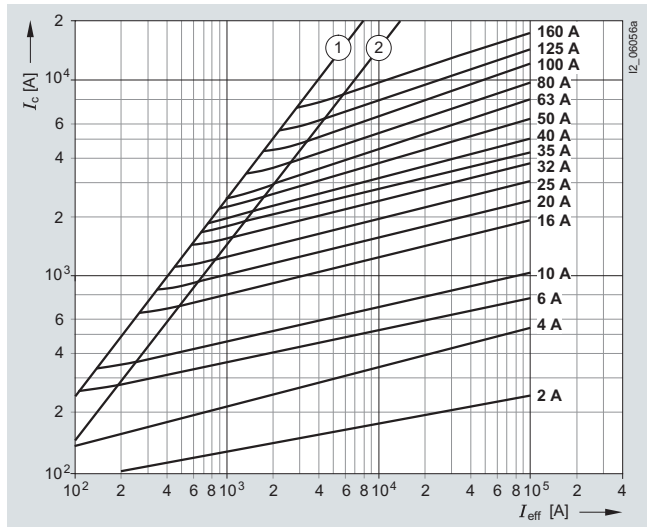

Table see page 68.

Current limitation diagram



- ① Peak short-circuit current with largest DC component
- ② Peak short-circuit current without DC component

Fuse Systems

LV HRC Fuse Systems

LV HRC bases and accessories,
3NH3, 3NG1, 3NX

Series 3NA3 8, 3NA6 8, 3NA7 8

Size: 000, 00
Operational class: gG
Rated voltage: 500 V AC/250 V DC
Rated current: 2 ... 160 A

Type	I_n	P_v	$\Delta\theta$	I^2t_s		I^2t_a		
	A	W	K	1 ms A ² s	4 ms A ² s	230 V AC A ² s	400 V AC A ² s	500 V AC A ² s
3NA3 802, 3NA6 802, 3NA7 802	2	1.3	8	2	2	4	6	9
3NA3 804, 3NA6 804, 3NA7 804	4	0.9	6	11	13	18	22	27
3NA3 801, 3NA6 801, 3NA7 801	6	1.3	8	46	50	80	110	150
3NA3 803, 3NA6 803, 3NA7 803	10	1	8	120	130	180	265	370
3NA3 805, 3NA6 805, 3NA7 805	16	1.7	11	370	420	580	750	1000
3NA3 807, 3NA6 807, 3NA7 807	20	2	15	670	750	1000	1370	1900
3NA3 810, 3NA6 810, 3NA7 810	25	2.3	17	1200	1380	1800	2340	3300
3NA3 812, 3NA6 812, 3NA7 812	32	2.6	18	2200	2400	3400	4550	6400
3NA3 814, 3NA3 814-7, 3NA6 814, 3NA7 814	35	2.7	21	3000	3300	4900	6750	9300
3NA3 817, 3NA6 817, 3NA7 817	40	3.1	24	4000	4500	6100	8700	12100
3NA3 820, 3NA3 820-7, 3NA6 820, 3NA7 820	50	3.8	25	6000	6800	9100	11600	16000
3NA3 822, 3NA3 822-7, 3NA6 822, 3NA7 822	63	4.6	28	7700	9800	14200	19000	26500
3NA3 824, 3NA3 824-7, 3NA6 824, 3NA6 824-7, 3NA7 824, 3NA7 824-7	80	5.8	33	12000	16000	23100	30700	43000
3NA3 830, 3NA3 830-7, 3NA6 830, 3NA6 830-7, 3NA7 830, 3NA7 830-7	100	6.6	34	24000	30600	40800	56200	80000
3NA3 832, 3NA6 832, 3NA7 832	125	8.9	44	36000	50000	70000	91300	130000
3NA3 832-8	125	7.2	30	46000	45000	97000	117000	134000
3NA3 836, 3NA6 836, 3NA7 836	160	11.3	52	58000	85000	120000	158000	223000
3NA3 836-8	160	9	34	89000	84800	137000	166000	--

Fuse Systems

LV HRC Fuse Systems

LV HRC bases and accessories,
3NH3, 3NG1, 3NX

Series 3NA3 8..-6, 3NA6 8..-6, 3NA7 8..-6

Size: 000, 00
Operational class: gG
Rated voltage: 690 V AC/250 V DC
Rated current: 2 ... 100 A

Time/current characteristics diagram

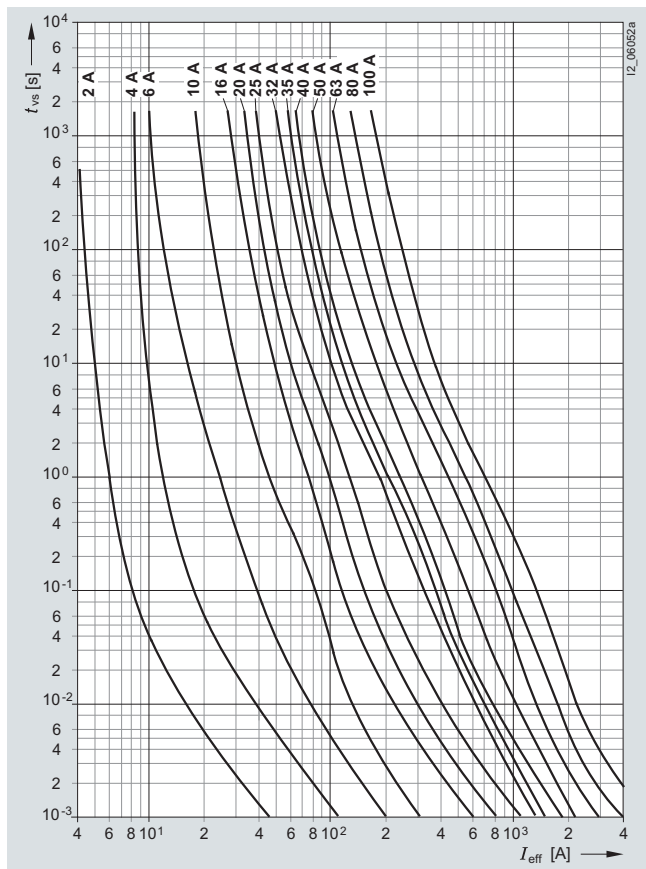

Melting I²t values diagram

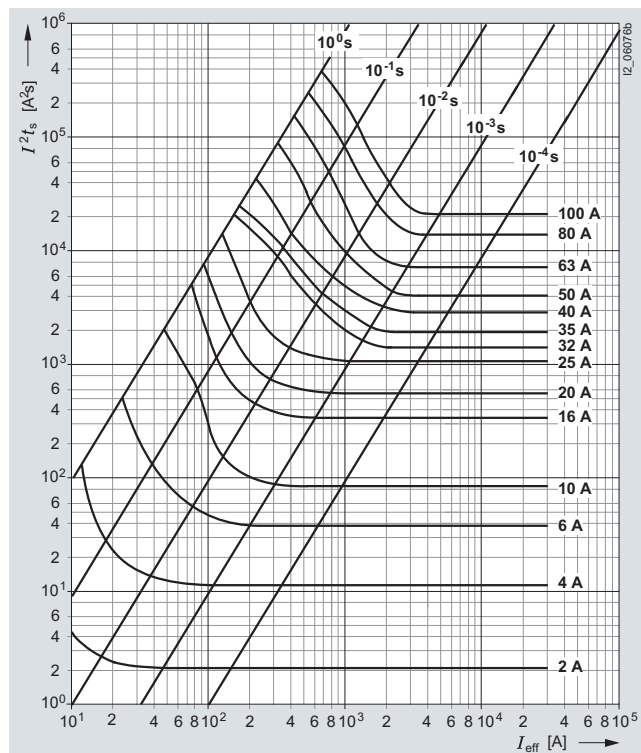

Current limitation diagram

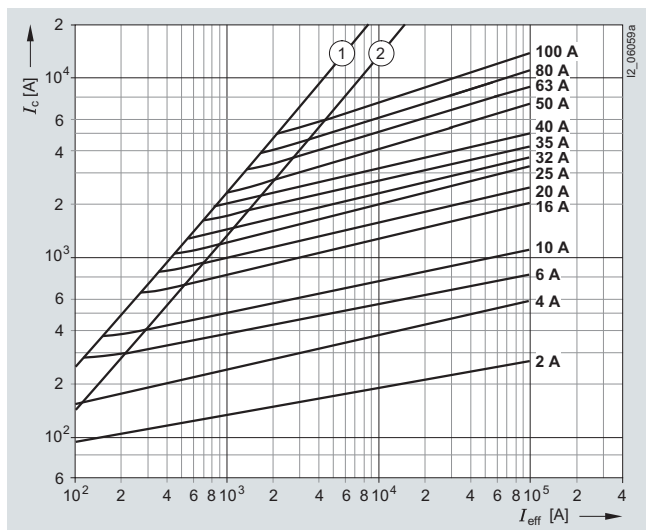

- ① Peak short-circuit current with largest DC component
- ② Peak short-circuit current without DC component

Type	I_n	P_v	$\Delta\theta$	I^2t_s	
	A	W	K	1 ms A ² s	4 ms A ² s
3NA3 802-6, 3NA6 802-6, 3NA7 802-6	2	1.3	8	2	2
3NA3 804-6, 3NA6 804-6, 3NA7 804-6	4	0.9	6	11	13
3NA3 801-6, 3NA6 801-6, 3NA7 801-6	6	1.3	8	36	44
3NA3 803-6, 3NA6 803-6, 3NA7 803-6	10	1	8	90	120
3NA3 805-6, 3NA6 805-6, 3NA7 805-6	16	1.7	11	330	360
3NA3 807-6, 3NA6 807-6, 3NA7 807-6	20	2	15	570	690
3NA3 810-6, 3NA6 810-6, 3NA7 810-6	25	2.3	17	1200	1380
3NA3 812-6, 3NA6 812-6, 3NA7 812-6	32	3.1	19	1600	2600
3NA3 814-6, 3NA6 814-6, 3NA7 814-6	35	3.6	23	2100	3100
3NA3 817-6, 3NA6 817-6, 3NA7 817-6	40	3.6	18	3200	4700
3NA3 820-6, 3NA6 820-6, 3NA7 820-6	50	4.9	28	4400	7400
3NA3 822-6, 3NA6 822-6, 3NA7 822-6	63	5.7	33	7600	10100
3NA3 824-6, 3NA6 824-6, 3NA7 824-6	80	6.7	38	13500	17000
3NA3 830-6, 3NA6 830-6, 3NA7 830-6	100	9.1	40	21200	30500

Type	I^2t_a		
	230 V AC A ² s	400 V AC A ² s	690 V AC A ² s
3NA3 802-6, 3NA6 802-6, 3NA7 802-6	4	6	9
3NA3 804-6, 3NA6 804-6, 3NA7 804-6	18	22	27
3NA3 801-6, 3NA6 801-6, 3NA7 801-6	80	110	150
3NA3 803-6, 3NA6 803-6, 3NA7 803-6	180	265	370
3NA3 805-6, 3NA6 805-6, 3NA7 805-6	580	750	1000
3NA3 807-6, 3NA6 807-6, 3NA7 807-6	1000	1370	1900
3NA3 810-6, 3NA6 810-6, 3NA7 810-6	1800	2340	3300
3NA3 812-6, 3NA6 812-6, 3NA7 812-6	3100	4100	5800
3NA3 814-6, 3NA6 814-6, 3NA7 814-6	4000	5000	7800
3NA3 817-6, 3NA6 817-6, 3NA7 817-6	6000	8600	12000
3NA3 820-6, 3NA6 820-6, 3NA7 820-6	9100	11200	19000
3NA3 822-6, 3NA6 822-6, 3NA7 822-6	13600	17000	24000
3NA3 824-6, 3NA6 824-6, 3NA7 824-6	24300	32000	55000
3NA3 830-6, 3NA6 830-6, 3NA7 830-6	42400	52000	75000

Fuse Systems

LV HRC Fuse Systems

LV HRC bases and accessories,
3NH3, 3NG1, 3NX

Series 3NA6 1...4

Size: 1
Operational class: gG
Rated voltage: 400 V AC
Rated current: 35 ... 250 A

Time/current characteristics diagram

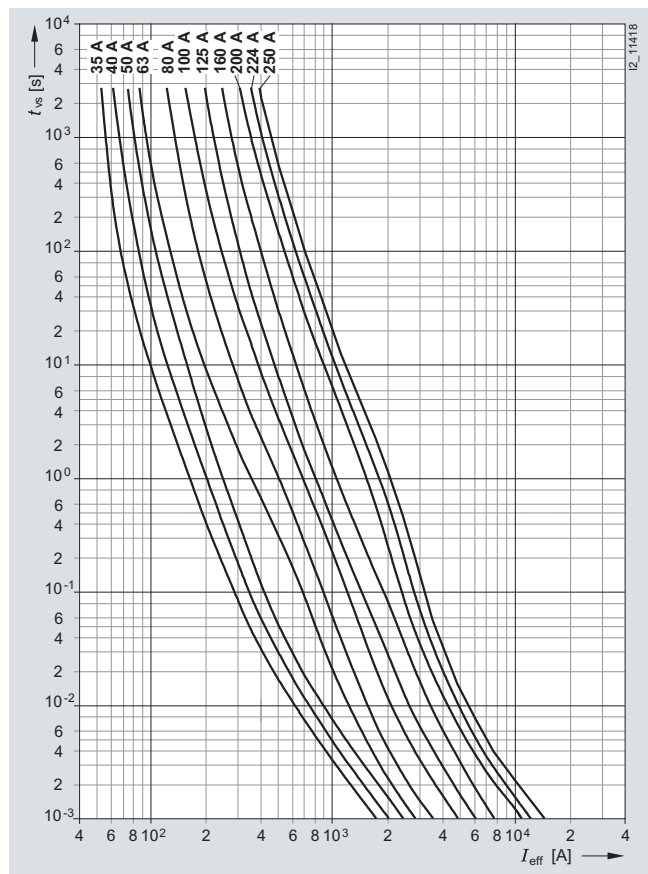

Current limitation diagram

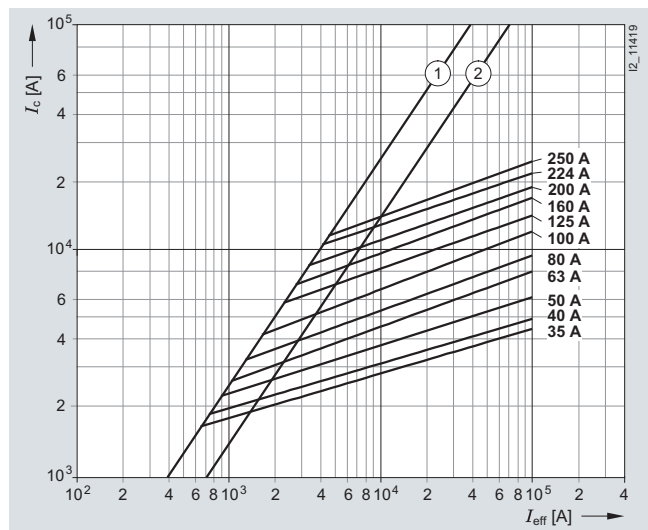

- ① Peak short-circuit current with largest DC component
- ② Peak short-circuit current without DC component

Melting I^2t values diagram

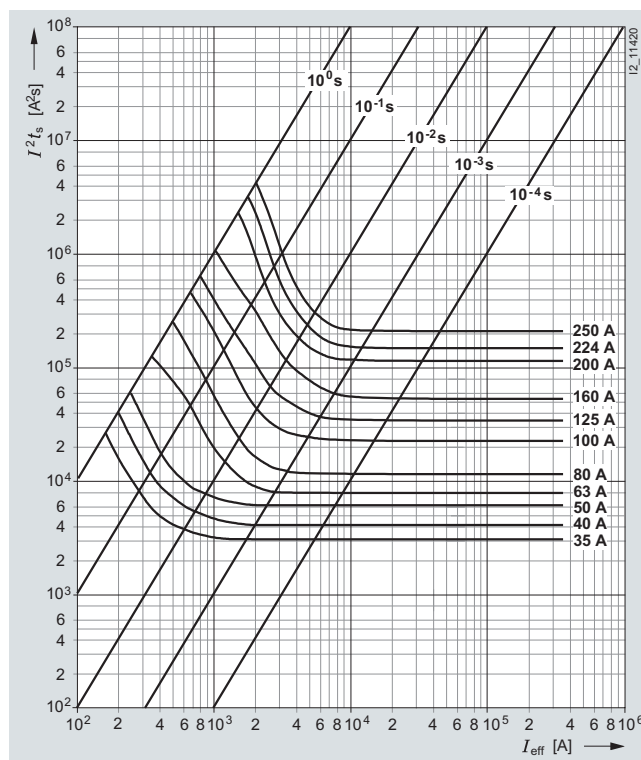

Type	I_n	P_v	$\Delta\theta$
	A	W	K
3NA6 114-4	35	3.2	16
3NA6 117-4	40	3.6	16
3NA6 120-4	50	4.6	20
3NA6 122-4	63	6.0	21
3NA6 124-4	80	7.5	29
3NA6 130-4	100	8.9	30
3NA6 132-4	125	10.7	31
3NA6 136-4	160	13.9	34
3NA6 140-4	200	15.0	36
3NA6 142-4	224	16.1	37
3NA6 144-4	250	17.3	39

Type	I^2t_s	I^2t_a	230 V AC	400 V AC
	1 ms A ² s	4 ms A ² s		
3NA6 114-4	3000	3300	4900	6750
3NA6 117-4	4000	4500	6100	8700
3NA6 120-4	6000	6800	9100	11600
3NA6 122-4	7700	9800	14200	19000
3NA6 124-4	12000	16000	23100	30700
3NA6 130-4	24000	30600	40800	56200
3NA6 132-4	36000	50000	70000	91300
3NA6 136-4	58000	85000	120000	158000
3NA6 140-4	115000	135000	218000	285000
3NA6 142-4	145000	170000	299000	392000
3NA6 144-4	205000	230000	420000	551000

Series 3NA6 2...-4

Size: 2
Operational class: gG
Rated voltage: 400 V AC
Rated current: 50 ... 400 A

Time/current characteristics diagram

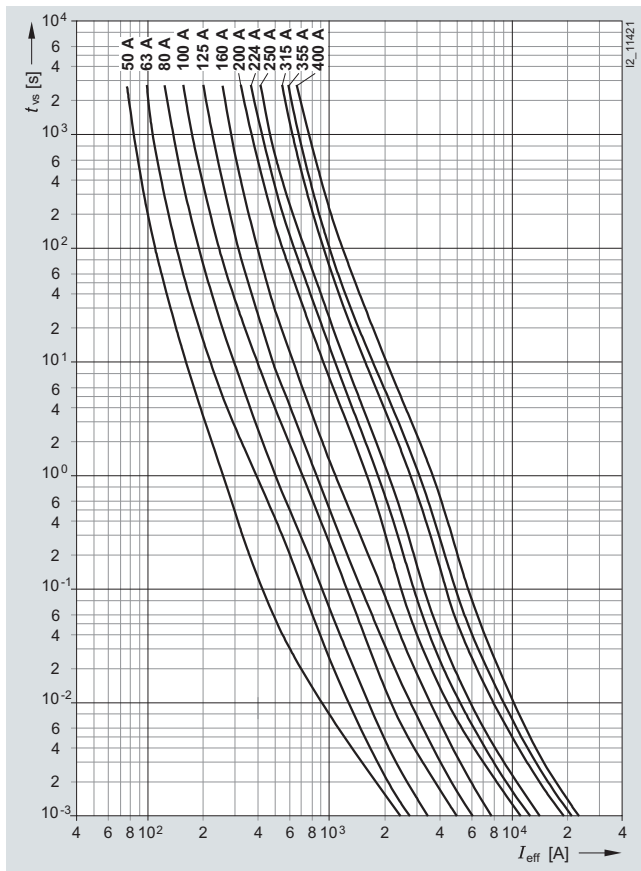

Current limitation diagram

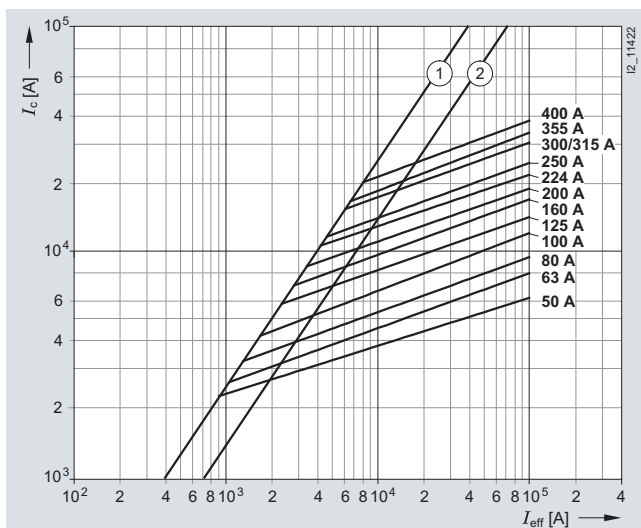

- ① Peak short-circuit current with largest DC component
- ② Peak short-circuit current without DC component

Melting I^2t values diagram

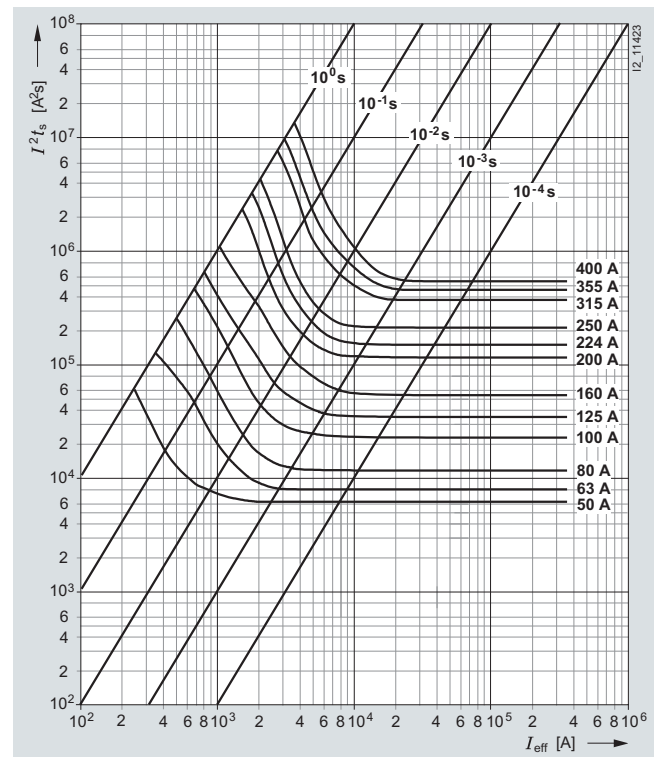

Type	I_n	P_v	$\Delta\theta$
	A	W	K
3NA6 220-4	50	4.7	16
3NA6 222-4	63	5.9	16
3NA6 224-4	80	6.8	21
3NA6 230-4	100	7.4	22
3NA6 232-4	125	9.8	27
3NA6 236-4	160	12.6	34
3NA6 240-4	200	14.9	33
3NA6 242-4	224	15.4	31
3NA6 244-4	250	17.9	38
3NA6 250-4	300	19.4	34
3NA6 252-4	315	21.4	35
3NA6 254-4	355	26.0	49
3NA6 260-4	400	27.5	52

Type	I^2t_s		I^2t_a	
	1 ms A ² s	4 ms A ² s	230 V AC A ² s	400 V AC A ² s
3NA6 220-4	6000	6800	9100	11600
3NA6 222-4	7700	9800	14200	19000
3NA6 224-4	12000	16000	23100	30700
3NA6 230-4	24000	30600	40800	56200
3NA6 232-4	36000	50000	70000	91300
3NA6 236-4	58000	85000	120000	158000
3NA6 240-4	115000	135000	218000	285000
3NA6 242-4	145000	170000	299000	392000
3NA6 244-4	205000	230000	420000	551000
3NA6 250-4	361000	433000	670000	901000
3NA6 252-4	361000	433000	670000	901000
3NA6 254-4	441000	538000	800000	1060000
3NA6 260-4	529000	676000	1155000	1515000

Fuse Systems

LV HRC Fuse Systems

LV HRC bases and accessories,
3NH3, 3NG1, 3NX

Series 3NA6 8..-4/-4KK

Size: 000, 00
Operational class: gG
Rated voltage: 400 V AC
Rated current: 10 ... 160 A

Time/current characteristics diagram

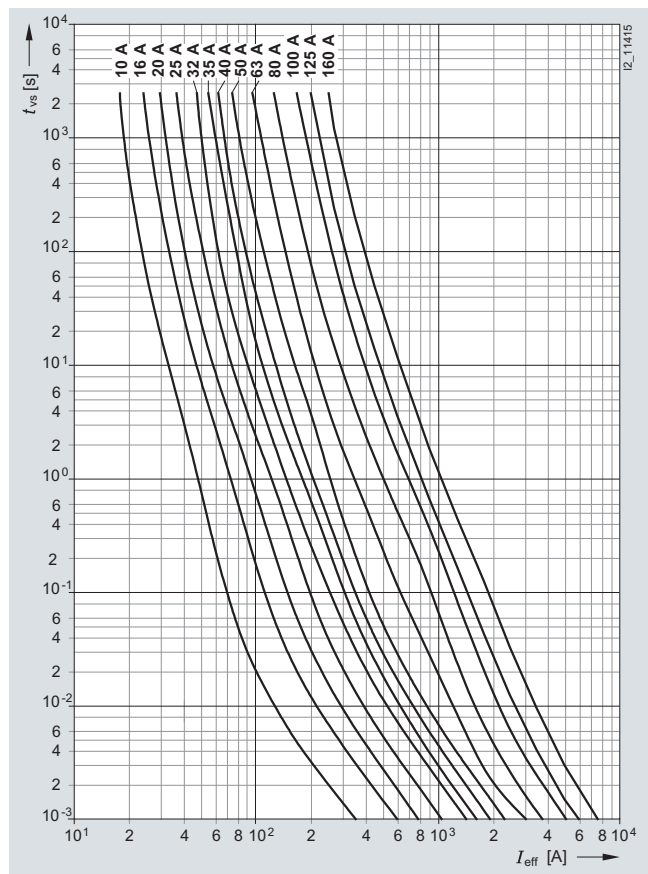

Melting I²t values diagram

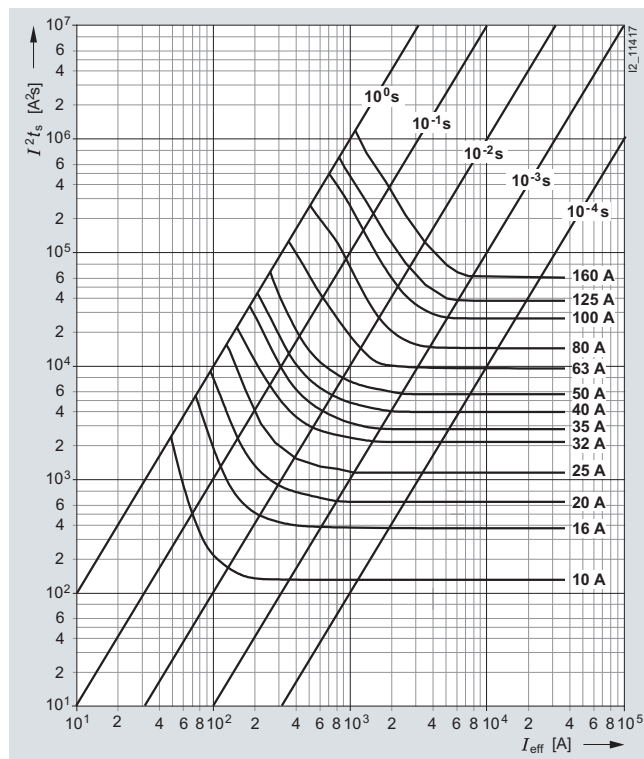

Current limitation diagram

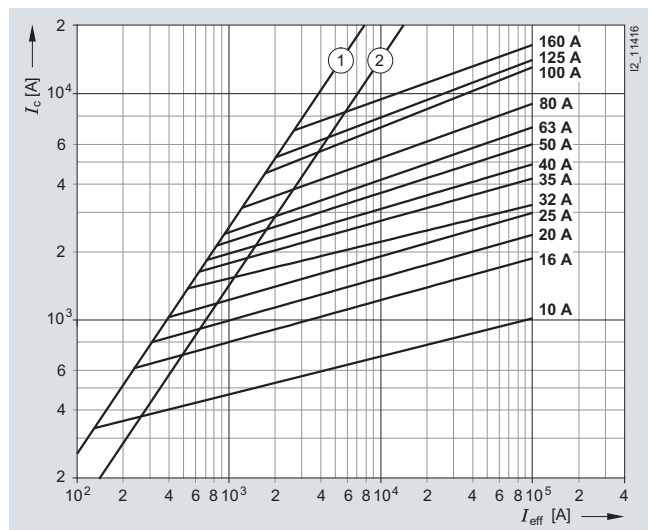

- ① Peak short-circuit current with largest DC component
- ② Peak short-circuit current without DC component

Type	I _n A	P _V W	Δθ K	I ² t _a	
				1 ms A ² s	4 ms A ² s
3NA6 803-4	10	1.0	8	120	130
3NA6 805-4	16	1.7	11	370	420
3NA6 807-4	20	2.0	15	670	750
3NA6 810-4	25	2.3	17	1200	1380
3NA6 812-4	32	2.6	18	2200	2500
3NA6 814-4	35	2.7	21	3000	3300
3NA6 817-4	40	3.1	24	4000	4500
3NA6 820-4	50	3.8	25	6000	6800
3NA6 822-4	63	3.9	23	9300	10250
3NA6 824-4, 3NA6 824-4KK	80	4.9	26	14200	18300
3NA6 830-4, 3NA6 830-4KK	100	5.4	29	25600	33600
3NA6 832-4	125	8.9	44	36000	50000
3NA6 836-4	160	11.3	52	58000	85000

Type	I ² t _a	
	230 V AC A ² s	400 V AC A ² s
3NA6 803-4	180	265
3NA6 805-4	580	750
3NA6 807-4	1000	1370
3NA6 810-4	1800	2340
3NA6 812-4	3400	4550
3NA6 814-4	4900	6750
3NA6 817-4	6100	8700
3NA6 820-4	9100	11600
3NA6 822-4	12400	17900
3NA6 824-4, 3NA6 824-4KK	27000	38000
3NA6 830-4, 3NA6 830-4KK	48300	69200
3NA6 832-4	70000	91300
3NA6 836-4	120000	158000

Fuse Systems

LV HRC Fuse Systems

LV HRC bases and accessories,
3NH3, 3NG1, 3NX

Series 3ND1 8

Size: 000, 00
Operational class: aM
Rated voltage: 500 V AC
Rated current: 6 ... 160 A

Time/current characteristics diagram

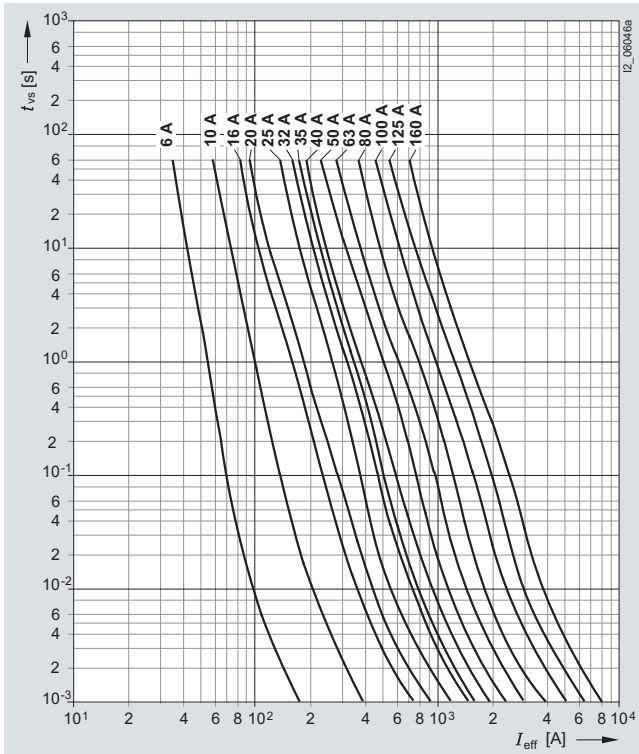

Melting I²t values diagram

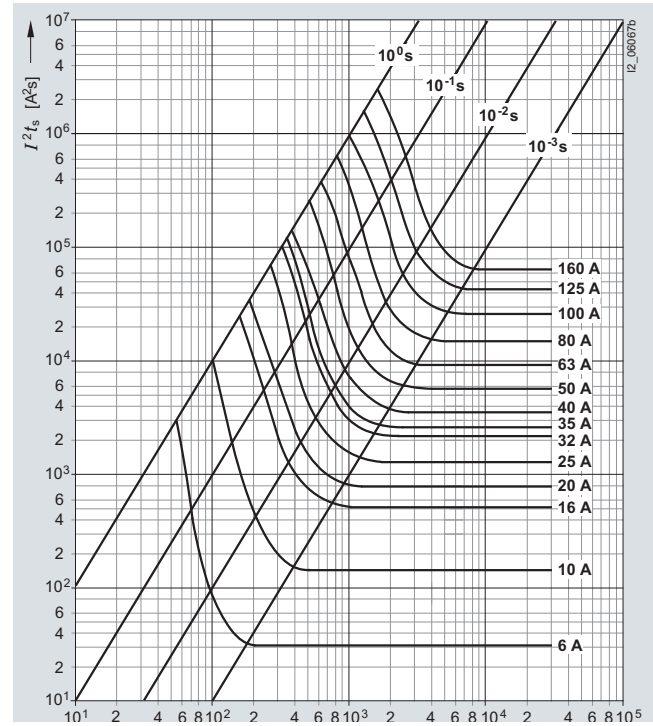

Current limitation diagram

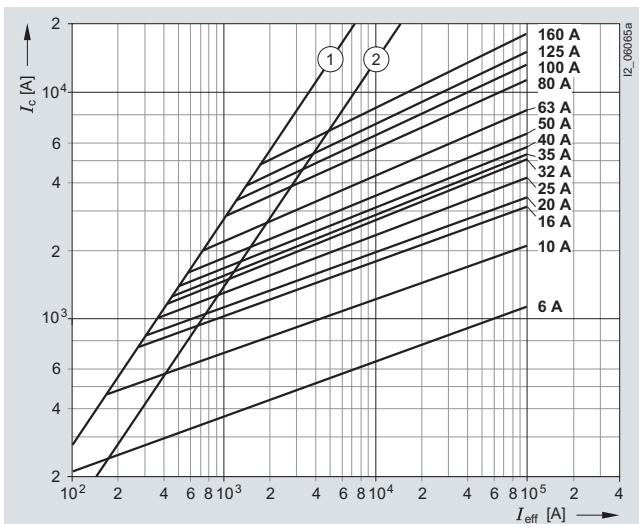

- ① Peak short-circuit current with largest DC component
- ② Peak short-circuit current without DC component

Type	I_n	P_v	$\Delta\theta$	I^2t_s	
	A	W	K	1 ms A ² s	4 ms A ² s
3ND1 801	6	0.8	7	32	55
3ND1 803	10	0.5	5	150	260
3ND1 805	16	0.8	7	570	800
3ND1 807	20	1	8	830	1200
3ND1 810	25	1.2	9	1400	2000
3ND1 812	32	1.5	10	2300	3300
3ND1 814	35	1.8	11	2600	3800
3ND1 817	40	2	12	3700	5500
3ND1 820	50	2.4	14	5800	8400
3ND1 822	63	3.3	17	9300	13000
3ND1 824	80	4.5	20	15000	21000
3ND1 830	100	4.9	18	26000	37000
3ND1 832	125	6.3	22	41000	60000
3ND1 836	160	9.3	31	64000	92000

Type	I^2t_a		
	230 V AC A ² s	400 V AC A ² s	500 V AC A ² s
3ND1 801	60	75	110
3ND1 803	280	320	430
3ND1 805	1000	1300	1600
3ND1 807	1300	1600	2200
3ND1 810	2200	2800	3300
3ND1 812	3800	4500	5400
3ND1 814	4200	5100	6300
3ND1 817	5700	7200	9300
3ND1 820	5200	10500	12500
3ND1 822	15000	16500	21000
3ND1 824	21500	27000	34000
3ND1 830	44000	56000	76000
3ND1 832	76000	98000	135000
3ND1 836	105000	130000	170000

Fuse Systems

LV HRC Fuse Systems

LV HRC bases and accessories,
3NH3, 3NG1, 3NX

Series 3ND1 3..., 3ND2

Size: 1, 2, 3
Operational class: aM
Rated voltage: 690 V AC
Rated current: 63 ... 630 A

Time/current characteristics diagram

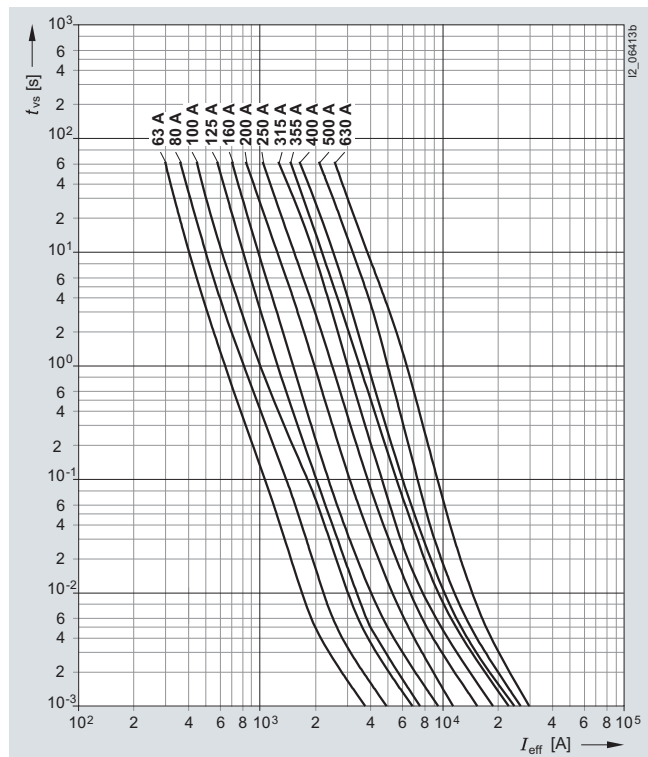

Melting I^2t values diagram

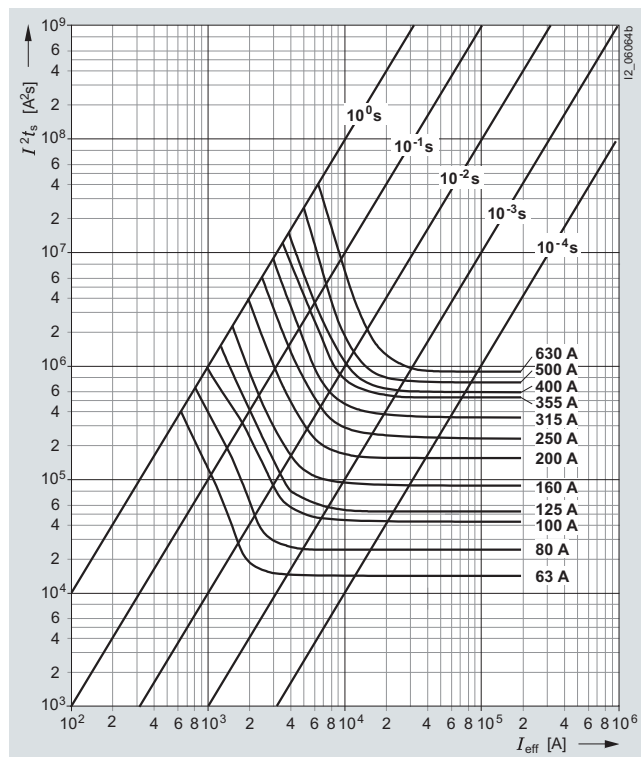

Current limitation diagram

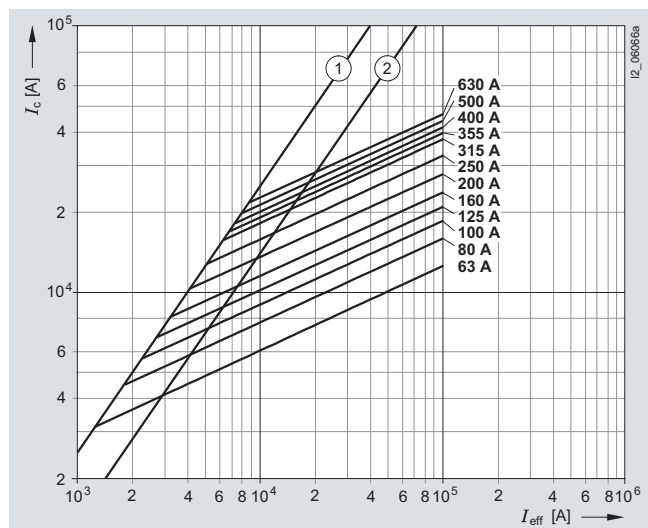

- ① Peak short-circuit current with largest DC component
- ② Peak short-circuit current without DC component

Table see page 75.

Series 3ND1 3..., 3ND2

Size: 1, 2, 3
 Operational class: aM
 Rated voltage: 690 V AC
 Rated current: 63 ... 630 A

Type	I_n	P_v	$\Delta\vartheta$	$I^2 t_s$		$I^2 t_a$		
	A	W	K	1 ms A ² s	4 ms A ² s	230 V AC A ² s	400 V AC A ² s	690 V AC A ² s
3ND2 122	63	4	12.2	14000	17700	19300	25600	42000
3ND2 124	80	4.9	13	24200	30800	36500	48000	80000
3ND2 130	100	5.8	15	45600	59000	65000	85000	140000
3ND2 132	125	8.1	16.5	57000	74300	73000	97000	160000
3ND2 136	160	11.4	18	90000	114000	107000	142000	235000
3ND2 140	200	14.1	19.5	150000	198000	172000	228000	375000
3ND2 144	250	18	22	250000	313000	260000	340000	565000
3ND2 232	125	8.1	16.5	57000	74300	73000	97000	160000
3ND2 236	160	11.4	18	90000	114000	107000	142000	235000
3ND2 240	200	14.1	19.5	150000	198000	172000	228000	375000
3ND2 244	250	18	22	250000	313000	260000	340000	565000
3ND2 252	315	22.6	30	370000	450000	460000	610000	1000000
3ND2 254	355	24.7	29	540000	643000	645000	855000	1400000
3ND2 260	400	30.8	35	615000	750000	688000	910000	1500000
3ND2 352	315	22.6	30	370000	450000	460000	610000	1000000
3ND2 354	355	24.7	29	540000	643000	645000	855000	1400000
3ND2 360	400	30.8	26	615000	750000	688000	910000	1500000
3ND1 365	500	47	40	730000	933000	876000	1095000	1825000
3ND1 372	630	50	43	920000	1375000	1300000	1800000	2600000

More information

Load capability with increased ambient temperature

The time/current characteristic of the NEOZED/DIAZED/LV HRC fuse links is based on an ambient temperature of 20 °C ±5 °C in accordance with DIN VDE 0636. When used in higher ambient temperatures (see diagram) a reduced load-carrying capacity must be planned for. At an ambient temperature of 50 °C, for example, an LV HRC fuse link should be dimensioned for only 90 % of the rated current. While the short-circuit behavior is not influenced by an increased ambient temperature, it is influenced by overload and operation at rated value.

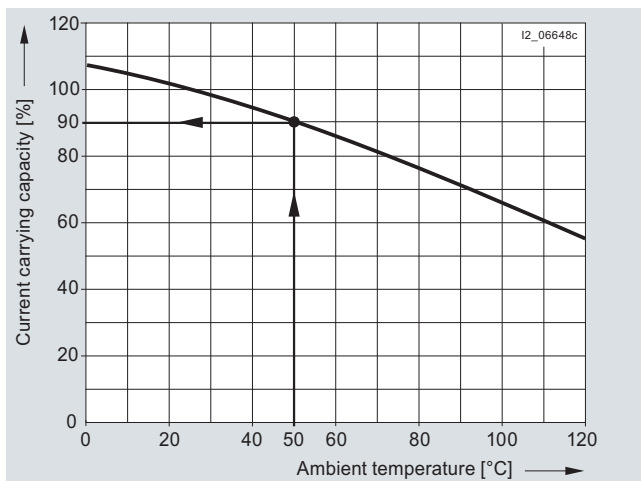

Influence of the ambient temperature on the load capability of NEOZED, DIAZED and NH fuse systems of gG operational class with natural convection in the distribution board.

Assignment of cable and line protection

When gG fuses are assigned for cable and line protection against overloading, the following conditions must be met in order to comply with DIN VDE 0100 Part 430:

- (1) $I_B = I_n = I_Z$ (rated current rule)
- (2) $I_2 = 1.45 \times I_Z$ (tripping rule)

I_B : Operational current of electrical circuit

I_n : Rated current of selected protective device

I_Z : Permissible current carrying capacity of the cable or line under specified operating conditions

I_2 : Tripping current of the protective device under specified operating conditions ("conventional test current").

These days, the factor 1.45 has become an internationally accepted compromise of the protection and utilization ratio of a line, taking into account the breaking behavior of the protective device (e.g. fuse).

In compliance with the supplementary requirements for DIN VDE 0636, Siemens fuse links of gG operational class comply with the following conditions:

"Load breaking switching with $I_2 = 1.45 \times I_n$ during conventional test duration under special test conditions in accordance with the aforementioned supplementary requirements of DIN VDE 0636".

This therefore permits direct assignment.

Fuse systems

SITOR semiconductor fuses

LV HRC design, 3NC, 3NE

Overview

SITOR fuses protect power semiconductors from the effects of short circuits because the super quick disconnect characteristic is far quicker than with conventional LV HRC fuses. They protect expensive devices and system components, such as converters with fuses in the input and the DC link, UPS systems and soft starters for motors.

Panel mounting requirements have given rise to various connection versions and designs.

The fuses with blade contacts comply with IEC 60269-2 and are suitable for installation in LV HRC fuse bases, in LV HRC fuse switch disconnectors and switch disconnectors with fuses. They also include fuses with slotted blade contacts for screw fixing with 110 mm mounting dimension, whose sizes are according to IEC 60269-4.

Fuses with slotted blade contacts for screw fixing with 80 mm or 110 mm mounting dimension are often screwed directly onto busbars for optimum heat dissipation. Even better heat transmission is provided by the compact fuses with M10 or M12 female thread, which are also mounted directly onto busbars.

Bolt-on links with 80 mm mounting dimension are another panel-mounting version for direct busbar mounting.

The fuses for SITOR thyristor sets, railway rectifiers or electrolysis systems were developed specially for these applications.

The LV HRC bases useable for SITOR fuses and safety switching devices are on [page 49 et seq.](#)

The fuse characteristic curves and configuration information and the assignment of SITOR fuses to the 3NP and 3KL fuse bases and safety switching devices can be found on the Internet

<http://support.automation.siemens.com/WW/view/de/14474639/134300>

The new size 3 type ranges have a round ceramic body instead of a square one. These series are characterized by small I^2t values with low power dissipation and high capability under alternating load. The dimensions and functional dimensions correspond to the current standards IEC 60269-4/ EN 60269-4 (VDE 0636-4).

Note:

The ordering data of the fuses are listed in ascending order of the rated voltage in the selection tables.

Fuse systems SITOR semiconductor fuses

LV HRC design, 3NC, 3NE

Characteristics

SITOR fuse links protect converter equipment against short circuits.

The power semiconductors used in these devices (diodes, thyristors, GTOs and others) require high-speed elements for protection due to their low thermal capacity. SITOR fuse links (super quick fuse links for semiconductor protection) are ideal for this type of application.

The following types of short-circuit faults can occur:

- **Internal short circuit:**
A faulty semiconductor device causes a short circuit within the power converter.
- **External short circuit:**
A fault in the load causes a short circuit on the output side of the power converter.
- **Inverter shoot-throughs:**
In the event of a failure of the chassis converter control system during inverter operation (commutation failure), the converter connection forms a short-circuit type connection between the DC and AC power supply system.

Fuse links can be arranged in a number of ways within the converter connection. A distinction is made between phase fuses in three-phase current incoming feeders and, if applicable, DC fuses and arm fuses in the arms of the converter connections (see adjacent graphs). In the case of center tap connections, fuse links can only be arranged as phase fuses in three-phase current incoming feeders.

When using SITOR fuse links of operational class aR, the overload protection of converter equipment, up to approx.3.5 times the rated current of the fuse link, is taken from conventional protective devices (for example, thermal-delayed overload relays) or, in the case of controlled power converters, from the current limiter (exception: full range fuses).

As semiconductor protection, SITOR fuse links of the 3NE1 ...-0 series with gS operational class are also suitable for the overload and short-circuit protection of cables, lines and busbars. All other dual-function fuses of the SITOR series have a gR characteristic. Overload protection is ensured as long as the rated current of the SITOR fuse links of the series 3NE1 ...-0 is selected as $I_n \leq I_z$ (DIN VDE 0100 Part 430).

The rules of DIN VDE 0100 Part 430 must be applied when rating short-circuit protection for cables, lines and busbars.

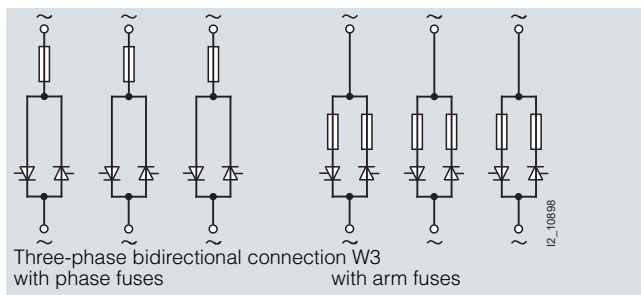

Configuration options

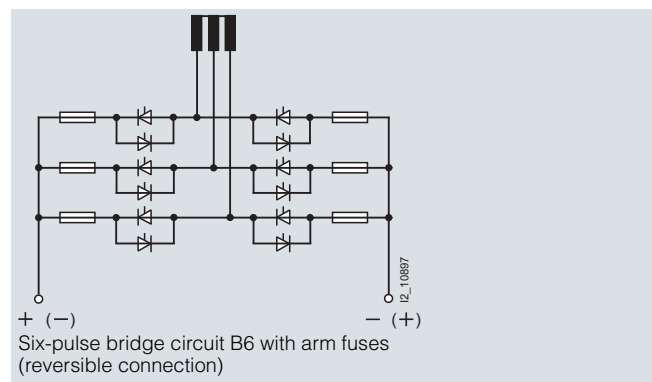
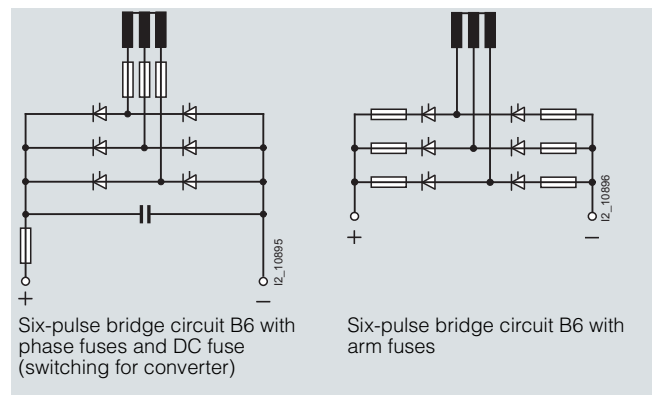
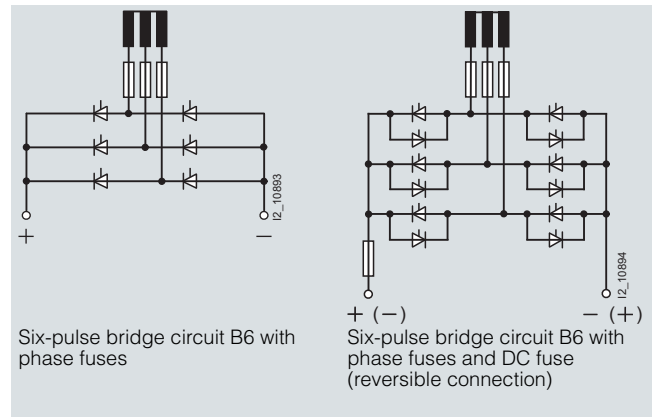

Fuse systems

SITOR semiconductor fuses

LV HRC design, 3NC, 3NE

Use in switch disconnectors

When using SITOR semiconductor fuses in 3KL and 3KM switch disconnectors with fuses and 3NP fuse switch disconnectors, the rated current of the fuse must sometimes be reduced due to the higher power loss compared to LV HRC fuses for line protection. Sometimes when using SITOR semiconductor fuses in switch disconnectors, the currents designated can be higher than the rated currents of the switches. These higher currents only apply when using SITOR switch disconnectors with semiconductor fuses and cannot be used when using switch disconnectors with standard LV HRC fuses. You will find further details in the following selection table.

When using SITOR semiconductor fuses of the 3NC2 4, 3NC8 4, 3NE3 3 and 3NE4 3 series, the standard switching capacity of the fuse must not be used as the blades of these fuses (in contrast to LV HRC fuses) are slotted. Occasional switching of currents up to the rated current of the fuses is permissible.

Due to the mechanical strain on the comparatively long fuse blade, SITOR semiconductor fuses of the 3NE4 1 series may

only be occasionally switched, and only without load. If only switching without load is permissible, this must be clearly stated on the switch itself.

The use of SITOR semiconductor fuses > 63 A for overload protection is not permitted – even if gR fuses are used (exception: 3NE1).

The operational voltage is limited by the rated voltage of the switch disconnector or the fuse. If switching without load, the limit value is the rated insulation voltage of the switch disconnector.

The 3NE1 "double protection fuses" can be used as full range fuses (gS) for semiconductor and line protection.

For further information on the assignment of SITOR fuses to the fuse bases and safety switching devices, please refer to the tables on pages 82 ff.

Technical specifications

MLFB	Operational class (IEC 60269)	Rated voltage U_n		Rated current I_n 1) A	Melting I^2t value I^2t_s ($t_{vs} = 1$ ms) A ² s	Breaking I^2t value I^2t_a at U_n A ² s	Temperature rise at I_n body center 2) K	Power dissipation at I_n W	Varying load factor WL
		V AC	V DC						
3NC2 423-0C	gR	500	--	150 ³⁾	7000	33000	26	35	0.85
3NC2 423-3C	gR	500	--	150 ³⁾	7000	33000	26	35	0.85
3NC2 425-0C	gR	500	--	200 ³⁾	13600	64000	25	40	0.85
3NC2 425-3C	gR	500	--	200 ³⁾	13600	64000	25	40	0.85
3NC2 427-0C	gR	500	--	250 ³⁾	21000	99000	30	50	0.85
3NC2 427-3C	gR	500	--	250 ³⁾	21000	99000	30	50	0.85
3NC2 428-0C	gR	500	--	300 ³⁾	28000	132000	40	65	0.85
3NC2 428-3C	gR	500	--	300 ³⁾	28000	132000	40	65	0.85
3NC2 431-0C	gR	500	--	350 ³⁾	53000	249000	35	60	0.85
3NC2 431-3C	gR	500	--	350 ³⁾	53000	249000	35	60	0.85
3NC2 432-0C	aR	500	--	400 ³⁾	83000	390000	30	50	0.85
3NC2 432-3C	aR	500	--	400 ³⁾	83000	390000	30	50	0.85
3NC3 236-1	aR	690	--	630	32500	244000	120	120	0.85
3NC3 236-6	aR	690	--	630	32500	244000	125	125	0.9
3NC3 237-1	aR	690	--	710	46100	346000	125	130	0.85
3NC3 237-6	aR	690	--	710	46100	346000	125	130	0.9
3NC3 238-1	aR	690	--	800	66400	498000	125	135	0.9
3NC3 238-6	aR	690	--	800	66400	498000	120	135	0.95
3NC3 240-1	aR	690	--	900	90300	677000	130	145	0.9
3NC3 240-6	aR	690	--	900	90300	677000	125	140	0.95
3NC3 241-1	aR	690	--	1000	130000	975000	125	155	0.95
3NC3 241-6	aR	690	--	1000	130000	975000	120	145	1
3NC3 242-1	aR	690	--	1100	184000	1382000	125	165	0.95
3NC3 242-6	aR	690	--	1100	184000	1382000	115	150	1
3NC3 243-1	aR	690	--	1250	265000	1990000	130	175	0.95
3NC3 243-6	aR	690	--	1250	265000	1990000	110	155	1
3NC3 244-1	aR	500	--	1400	382000	2100000	140	200	0.95
3NC3 244-6	aR	500	--	1400	382000	2100000	115	175	1
3NC3 245-1	aR	500	--	1600	520000	2860000	160	240	0.9
3NC3 245-6	aR	500	--	1600	520000	2860000	120	195	0.95
3NC3 336-1	aR	1000	--	630	66400	418000	160	145	0.85
3NC3 336-6	aR	1000	--	630	66400	418000	140	130	0.9
3NC3 337-1	aR	1000	--	710	90300	569000	160	150	0.85
3NC3 337-6	aR	1000	--	710	90300	569000	140	140	0.9
3NC3 338-1	aR	1000	--	800	130000	819000	150	155	0.85
3NC3 338-6	aR	1000	--	800	130000	819000	130	150	0.9
3NC3 340-1	aR	1000	--	900	184000	1160000	145	165	0.9
3NC3 340-6	aR	1000	--	900	184000	1160000	130	160	0.95
3NC3 341-1	aR	1000	--	1000	265000	1670000	140	170	0.9
3NC3 341-6	aR	1000	--	1000	265000	1670000	125	165	0.95
3NC3 342-1	aR	800	--	1100	382000	1910000	150	185	0.9
3NC3 342-6	aR	800	--	1100	382000	1910000	130	175	0.95
3NC3 343-1	aR	800	--	1250	520000	2600000	165	210	0.9
3NC3 343-6	aR	800	--	1250	520000	2600000	135	185	0.95
3NC3 430-1	aR	1250	--	315	10600	72500	60	80	0.95
3NC3 430-6	aR	1250	--	315	10600	72500	60	80	0.95

MLFB	Operational class (IEC 60269)	Rated voltage U_n	Rated voltage U_n	Rated current I_n	Melting I^2t value I^2t_s ($t_{vs} = 1$ ms)	Breaking I^2t value I^2t_a at U_n	Temperature rise at I_n body center	Power dissipation at I_n	Varying load factor WL
		V AC	V DC	1) A	A ² s	A ² s	2) K	W	
3NC3 432-1	aR	1250	--	400	23900	163000	95	95	0.95
3NC3 432-6	aR	1250	--	400	23900	163000	95	95	0.95
3NC3 434-1	aR	1250	--	500	42500	290000	115	115	0.9
3NC3 434-6	aR	1250	--	500	42500	290000	115	115	0.9
3NC3 436-1	aR	1250	--	630	96600	650000	120	120	0.95
3NC3 436-6	aR	1250	--	630	96600	650000	120	120	0.95
3NC3 438-1	aR	1100	--	800	170000	985000	145	145	0.9
3NC3 438-6	aR	1100	--	800	170000	985000	145	145	0.9
3NC5 531 ⁴⁾	aR	800	--	350 ⁵⁾	66000	260000	200	80	0.9
3NC5 838 ⁴⁾	aR	1000	--	800 ⁵⁾	360000	1728000	130	170	0.9
3NC5 840 ⁴⁾	aR	1000	--	600 ⁵⁾	185000	888000	110	150	0.9
3NC5 841 ⁴⁾	aR	800	--	630 ⁵⁾	185000	888000	110	145	0.9
3NC7 327-2	aR	680	--	250	244000	635000	45	25	0.9
3NC7 331-2	aR	680	--	350	550000	1430000	66	32	0.9
3NC8 423-0C	gR	690	--	150 ³⁾	1100	17600	33	40	0.85
3NC8 423-3C	gR	690	--	150 ³⁾	1100	17600	33	40	0.85
3NC8 425-0C	gR	690	--	200 ³⁾	2400	38400	46	55	0.85
3NC8 425-3C	gR	690	--	200 ³⁾	2400	38400	46	55	0.85
3NC8 427-0C	gR	690	--	250 ³⁾	4400	70400	95	72	0.85
3NC8 427-3C	gR	690	--	250 ³⁾	4400	70400	95	72	0.85
3NC8 431-0C	gR	690	--	350 ³⁾	11000	176000	65	95	0.85
3NC8 431-3C	gR	690	--	350 ³⁾	11000	176000	65	95	0.85
3NC8 434-0C	gR	690	--	500 ³⁾	28000	448000	75	130	0.85
3NC8 434-3C	gR	690	--	500 ³⁾	28000	448000	75	130	0.85
3NC8 444-3C	aR	600	--	1000	400000	2480000	110	140	0.9
3NE1 020-2	gR	690	--	80	780	5800	45	10.5	1
3NE1 021-0	gS	690	--	100	3100	33000	36	10	1
3NE1 021-2	gR	690	--	100	1490	11000	49	11.5	1
3NE1 022-0	gS	690	--	125	6000	63000	40	11	1
3NE1 022-2	gR	690	--	125	3115	23000	55	13.5	1
3NE1 224-0	gS	690	--	160	7400	60000	60	24	1
3NE1 224-2	gR	690	--	160	2650	18600	70	30	1
3NE1 224-3	gR	690	--	160	2650	18600	70	30	1
3NE1 225-0	gS	690	--	200	14500	100000	65	27	1
3NE1 225-2	gR	690	--	200	5645	51800	62	28	1
3NE1 225-3	gR	690	--	200	5645	51800	62	28	1
3NE1 227-0	gS	690	--	250	29500	200000	75	30	1
3NE1 227-2	gR	690	--	250	11520	80900	70	35	1
3NE1 227-3	gR	690	--	250	11520	80900	70	35	1
3NE1 230-0	gS	690	--	315	46100	310000	80	38	1
3NE1 230-2	gR	690	--	315	22580	168000	75	42	1
3NE1 230-3	gR	690	--	315	22580	168000	75	42	1
3NE1 331-0	gS	690	--	350	58000	430000	75	42	1
3NE1 331-2	gR	690	--	350	29500	177000	82	44	1
3NE1 331-3	gR	690	--	350	29500	177000	82	44	1
3NE1 332-0	gS	690	--	400	84000	590000	85	45	1
3NE1 332-2	gR	690	--	400	37300	177000	100	54	1
3NE1 332-3	gR	690	--	400	37300	177000	100	54	1
3NE1 333-0	gS	690	--	450	104000	750000	85	53	1
3NE1 333-2	gR	690	--	450	46100	276500	100	62	1
3NE1 333-3	gR	690	--	450	46100	276500	100	62	1
3NE1 334-0	gS	690	--	500	149000	950000	90	56	1
3NE1 334-2	gR	690	--	500	66400	398000	100	65	1
3NE1 334-3	gR	690	--	500	66400	398000	100	65	1
3NE1 435-0	gS	690	--	560	215000	1700000	65	50	1
3NE1 435-2	gR	690	--	560	130000	890000	80	60	1
3NE1 436-3	gR	690	--	560	130000	890000	80	60	1
3NE1 436-0	gS	690	--	630	293000	2350000	70	55	1
3NE1 436-2	gR	690	--	630	203000	1390000	82	62	1
3NE1 436-3	gR	690	--	630	203000	1390000	82	62	1
3NE1 437-0	gS	690	--	710	437000	3400000	68	60	1
3NE1 437-1	gR	600	--	710	321000	2460000	85	65	1
3NE1 437-2	gR	690	--	710	265000	1818000	90	72	1
3NE1 437-3	gR	690	--	710	265000	1818000	90	72	1

Fuse systems

SITOR semiconductor fuses

LV HRC design, 3NC, 3NE

MLFB	Operational class (IEC 60269)	Rated voltage U_n	Rated voltage U_n	Rated current I_n	Melting I^2t value I^2t_s ($t_{vs} = 1 \text{ ms}$)	Breaking I^2t value I^2t_b at U_n	Temperature rise at I_n body center	Power dissipation at I_n	Varying load factor WL
		V AC	V DC	1) A	A ² s	A ² s	2) K	W	
3NE1 438-0	gS	690	--	800	723000	5000000	70	59	1
3NE1 438-1	gR	600	--	800	437000	3350000	95	72	1
3NE1 438-2	gR	690	--	800	361000	2475000	95	82	1
3NE1 438-3	gR	690	--	800	361000	2475000	95	82	1
3NE1 447-2	gR	690	--	670	240000	1640000	90	65	1
3NE1 447-3	gR	690	--	670	240000	1640000	90	65	1
3NE1 448-2	gR	690	--	850	520000	3640000	95	76	1
3NE1 448-3	gR	690	--	850	520000	3640000	95	76	1
3NE1 802-0	gS	690	--	40	295	3000	30	5	1
3NE1 803-0	gS	690	--	35	166	1700	35	5	1
3NE1 813-0	gS	690	--	16	18	200	25	3	1
3NE1 814-0	gS	690	--	20	41	430	25	3.5	1
3NE1 815-0	gS	690	--	25	74	780	30	4	1
3NE1 817-0	gS	690	--	50	461	4400	35	6	1
3NE1 818-0	gS	690	--	63	903	9000	40	7	1
3NE1 820-0	gS	690	--	80	1843	18000	40	8	1
3NE3 221	aR	1000	--	100	665	4800	65	28	0.95
3NE3 222	aR	1000	--	125	1040	7200	70	36	0.95
3NE3 224	aR	1000	--	160	1850	13000	90	42	1
3NE3 225	aR	1000	--	200	4150	30000	80	42	1
3NE3 227	aR	1000	--	250	6650	48000	90	50	1
3NE3 230-0B	aR	1000	--	315	13400	80000	100	65	0.95
3NE3 231	aR	1000	--	350	16600	100000	120	75	0.9
3NE3 232-0B	aR	1000	--	400	22600	135000	140	85	0.9
3NE3 233	aR	1000	--	450	29500	175000	130	95	0.9
3NE3 332-0B	aR	1000	--	400	22600	135000	120	85	1
3NE3 333	aR	1000	--	450	29500	175000	125	90	1
3NE3 334-0B	aR	1000	--	500	46100	260000	115	90	1
3NE3 335	aR	1000	--	560	66500	360000	120	95	1
3NE3 336	aR	1000	--	630	104000	600000	110	100	1
3NE3 337-8	aR	900	--	710	149000	800000	125	110	1
3NE3 338-8	aR	800	--	800	184000	850000	140	130	0.95
3NE3 340-8	aR	690	--	900	223000	920000	160	165	0.95
3NE3 421-0C	aR	1000	--	100	1800	13500	45	25	1
3NE3 430-0C	aR	1000	--	315	29000	218000	120	80	1
3NE3 432-0C	aR	1000	--	400	48500	364000	130	110	1
3NE3 434-0C	aR	1000	--	500	116000	870000	120	95	1
3NE3 525-5 ⁶⁾	aR	1000	--	200 ⁷⁾	7150	44000	75	50	0.85
3NE3 535-5 ⁶⁾	aR	1000	--	450 ⁷⁾	64500	395000	130	90	0.85
3NE3 626-0C	aR	1000	--	224	7200	54000	140	85	1
3NE3 635-0C	aR	1000	--	450	65000	488000	150	110	1
3NE3 635-6	aR	1000	--	450	65000	488000	150	110	1
3NE3 636-0C	aR	1000	--	630	170000	1280000	136	132	1
3NE3 637-0C	aR	1000	--	710	260000	1950000	170	145	1
3NE3 637-1C ⁸⁾	aR	1000	--	710	260000	1950000	170	145	1
3NE4 101	gR	1000	--	32	40	280	45	12	0.9
3NE4 102	gR	1000	--	40	75	500	50	13	0.9
3NE4 117	gR	1000	--	50	120	800	65	16	0.9
3NE4 117-5	gR	1000	--	50	135	1100	95	20	0.85
3NE4 118	aR	1000	--	63	230	1500	78	20	0.9
3NE4 120	aR	1000	--	80	450	3000	82	22	0.9
3NE4 121	aR	1000	--	100	900	6000	85	24	0.9
3NE4 121-5	aR	1000	--	100	900	7400	135	35	0.85
3NE4 122	aR	1000	--	125	1800	14000	100	30	0.9
3NE4 124	aR	1000	--	160	3600	29000	120	35	0.9
3NE4 146-5	aR	800	--	170	7370	60500	142	43	0.85
3NE4 327-0B	aR	800	--	250	3600	29700	175	105	0.85
3NE4 327-6B ⁶⁾	aR	800	--	250	3600	29700	175	105	0.85
3NE4 330-0B	aR	800	--	315	7400	60700	170	120	0.85
3NE4 330-6B ⁶⁾	aR	800	--	315	7400	60700	170	120	0.85
3NE4 333-0B	aR	800	--	450	29400	191000	190	140	0.85
3NE4 333-6B ⁶⁾	aR	800	--	450	29400	191000	190	140	0.85
3NE4 334-0B	aR	800	--	500	42500	276000	195	155	0.85
3NE4 334-6B ⁶⁾	aR	800	--	500	42500	276000	195	155	0.85
3NE4 337	aR	800	--	710	142000	923000	170	155	0.95
3NE4 337-6 ⁶⁾	aR	800	--	710	142000	923000	170	155	0.95

MLFB	Operational class (IEC 60269)	Rated voltage U_n	Rated voltage U_n	Rated current I_n	Melting I^2t value I^2t_s ($t_{vs} = 1$ ms)	Breaking I^2t value I^2t_b at U_n	Temperature rise at I_n body center ²⁾	Power dissipation at I_n	Varying load factor WL
		V AC	V DC						
3NE5 424-0C	aR	1500	--	160	7200	54000	75	56	1
3NE5 426-0C	aR	1500	--	224	18400	138000	100	80	1
3NE5 430-0C	aR	1500	--	315	41500	311000	125	115	1
3NE5 431-0C	aR	1500	--	350	57000	428000	150	135	1
3NE5 433-0C	aR	1500	--	450	116000	870000	150	145	0.95
3NE5 433-1C	aR	1500	--	450	116000	870000	150	145	0.95
3NE5 627-0C	aR	1500	--	250	11200	84000	170	130	1
3NE5 633-0C	aR	1500	--	450	78500	590000	170	160	1
3NE5 643-0C	aR	1500	--	600	260000	1950000	160	145	1
3NE6 437	aR	900	--	710 ⁹⁾	100000	620000	80	150	0.9
3NE6 437-7	aR	900	--	710 ¹⁰⁾	100000	620000	110	150	0.9
3NE6 444	aR	900	--	900 ⁹⁾	400000	1920000	80	170	0.9
3NE7 425-0C	aR	2000	--	200	18400	138000	85	75	1
3NE7 427-0C	aR	2000	--	250	29000	218000	110	110	1
3NE7 431-0C	aR	2000	--	350	74000	555000	105	120	1
3NE7 432-0C	aR	2000	--	400	116000	870000	130	150	1
3NE7 633-0C	aR	2000	--	450	128000	960000	165	160	1
3NE7 633-1C ¹¹⁾	aR	2000	--	450	128000	960000	165	160	1
3NE7 636-0C	aR	2000	--	630	260000	1950000	200	220	1
3NE7 636-1C ¹¹⁾	aR	2000	--	630	260000	1950000	200	220	1
3NE7 637-1C ¹¹⁾	aR	2000	--	710	415000	3110000	230	275	1
3NE7 648-1C ¹¹⁾	aR	2000	--	525	149000	1120000	210	210	1
3NE8 003-1	gR	690	--	35	70	400	45	9	0.95
3NE8 015-1	gR	690	--	25	30	180	35	7	0.95
3NE8 017-1	gR	690	--	50	120	700	65	14	0.95
3NE8 018-1	gR	690	--	63	260	1400	70	16	0.95
3NE8 020-1	aR	690	--	80	450	2400	80	19	0.95
3NE8 021-1	aR	690	--	100	850	4200	90	22	0.95
3NE8 022-1	aR	690	--	125	1400	6500	110	28	0.95
3NE8 024-1	aR	690	--	160	2800	13000	130	38	0.95
3NE8 701-1	gR	690	700 ¹²⁾	32	40	285	45	10	0.9
3NE8 702-1	gR	690	700 ¹²⁾	40	69	490	55	12	0.9
3NE8 714-1	gR	690	700 ¹²⁾	20	12	83	40	7	0.9
3NE8 715-1	gR	690	700 ¹²⁾	25	19	140	40	9	0.9
3NE8 717-1	gR	690	700 ¹²⁾	50	115	815	60	15	0.9
3NE8 718-1	aR	690	700 ¹²⁾	63	215	1550	70	16	0.95
3NE8 720-1	aR	690	700 ¹²⁾	80	380	2700	80	18	0.9
3NE8 721-1	aR	690	700 ¹²⁾	100	695	4950	75	19	0.95
3NE8 722-1	aR	690	700 ¹²⁾	125	1250	9100	80	23	0.95
3NE8 724-1	aR	690	700 ¹²⁾	160	2350	17000	100	31	0.9
3NE8 725-1	aR	690	700 ¹²⁾	200	4200	30000	120	36	0.9
3NE8 727-1	aR	690	700 ¹²⁾	250	7750	55000	125	42	0.9
3NE8 731-1	aR	690	700 ¹²⁾	315	12000	85500	150	54	0.85
3NE9 440-6	gR	600	--	850	400000	2480000	74	85	1
3NE9 450	aR	600	--	1250 ⁹⁾	400000	2480000	80	210	0.9
3NE9 450-7	aR	600	--	1250 ¹⁰⁾	400000	2480000	105	210	0.9
3NE9 632-1C	aR	2500	--	400	81000	620000	160	205	1
3NE9 634-1C	aR	2500	--	500	170000	1270000	180	235	1
3NE9 636-1C	aR	2500	--	630	385000	2800000	198	275	1

1) Maximum tightening torque: M10 capped thread: 35 Nm, screw penetration depth ≥ 9 mm.

2) Temperature rise and power dissipation for operation in LV HRC fuse base.

3) Cooling air speed 1 m/s. In the case of natural air cooling, reduction of 5 %.

4) Maximum tightening torque:
 - M10 thread (with indicator): 40 Nm
 - M10 capped thread: 50 Nm, screw penetration depth ≥ 9 mm
 - M24 \times 1.5 thread: 60 Nm.

5) Temperature of water-cooled busbar max. +45 C.

6) Maximum tightening torque:
 M10 capped thread: 35 Nm, screw penetration depth ≥ 9 mm.

7) Cooling air speed ≥ 0.5 m/s. In the case of natural air cooling, reduction of 5 %.

8) Gauge 140 mm, M12 screw connection.

9) Cooling air speed ≥ 2 m/s.

10) Bottom (cooled) connection max. +60 °C, top connection (M10) max. +110 °C.

11) M12 screw connection

12) Rated voltage according to UL.

Fuse systems

SITOR semiconductor fuses

LV HRC design, 3NC, 3NE

Load rating of SITOR fuse links with 3NH LV HRC fuse bases

SITOR fuse links						\varnothing_{\min} Cu mm ²	LV HRC fuse bases			
Order No.	U_n V AC	Operational class	BG	I_n A	WL		Order No.	BG	I_{\max} A	I_{WL} A
3NC2 423-3C	500	gR	3	150	0.95	70	3NH3 420/3NH3 430	3	150	143
3NC2 425-3C	500	gR	3	200	0.95	95		3	190	181
3NC2 427-3C	500	gR	3	250	0.95	120		3	240	228
3NC2 428-3C	500	gR	3	300	0.95	185	3	285	271	
3NC2 431-3C	500	gR	3	350	0.95	240	3	330	314	
3NC2 432-3C	500	aR	3	400	0.95	240	3	400	380	
3NC3 336-1	1000	aR	3	630	0.85	480	3NH3 420/3NH3 430	3	560	476
3NC3 337-1	1000	aR	3	710	0.85	560		3	600	510
3NC3 338-1	1000	aR	3	800	0.85	640		3	640	544
3NC3 340-1	1000	aR	3	900	0.90	720	3	720	648	
3NC3 341-1	1000	aR	3	1000	0.90	800	3	800	720	
3NC3 342-1	800	aR	3	1100	0.90	880	3	880	792	
3NC3 343-1	800	aR	3	1250	0.90	960	3	950	855	
3NC8 423-3C	690	gR	3	150	0.85	70	3NH3 420/3NH3 430	3	135	115
3NC8 425-3C	690	gR	3	200	0.85	95		3	180	153
3NC8 427-3C	690	gR	3	250	0.85	120		3	250	213
3NC8 431-3C	690	gR	3	350	0.85	240	3	315	268	
3NC8 434-3C	690	gR	3	500	0.85	2 × 150	3	450	383	
3NC8 444-3C	600	aR	3	1000	0.95	2 × (60 × 6)	3	800	800	
3NE1 020-2	690	gR	00	80	1.0	25	3NH3 030/3NH4 030	00	80	80
3NE1 021-0	690	gS	00	100	1.0	35		00	100	100
3NE1 021-2	690	gR	00	100	1.0	35		00	100	100
3NE1 022-0	690	gS	00	125	1.0	50	00	125	125	
3NE1 022-2	690	gR	00	125	1.0	50	00	125	125	
3NE1 224-0	690	gS	1	160	1.0	70	3NH3 230/3NH4 230	1	160	160
3NE1 224-2	690	gR	1	160	1.0	70		1	160	160
3NE1 224-3	690	gR	1	160	1.0	70		1	160	160
3NE1 225-0	690	gS	1	200	1.0	95	1	200	200	
3NE1 225-2	690	gR	1	200	1.0	95	1	200	200	
3NE1 225-3	690	gR	1	200	1.0	95	1	200	200	
3NE1 227-0	690	gS	1	250	1.0	120	1	250	250	
3NE1 227-2	690	gR	1	250	1.0	120	1	250	250	
3NE1 227-3	690	gR	1	250	1.0	120	1	250	250	
3NE1 230-0	690	gS	1	315	1.0	2 × 70	3NH3 320/3NH3 330	2	315	315
3NE1 230-2	690	gR	1	315	1.0	2 × 70		2	315	315
3NE1 230-3	690	gR	1	315	1.0	2 × 70		2	315	315
3NE1 331-0	690	gS	2	350	1.0	2 × 95	3NH3 320/3NH3 330	2	350	350
3NE1 331-2	690	gR	2	350	1.0	2 × 95		2	350	350
3NE1 331-3	690	gR	2	350	1.0	2 × 95		2	350	350
3NE1 332-0	690	gS	2	400	1.0	2 × 95	2	400	400	
3NE1 332-2	690	gR	2	400	1.0	2 × 95	2	400	400	
3NE1 332-3	690	gR	2	400	1.0	2 × 95	2	400	400	
3NE1 333-0	690	gS	2	450	1.0	2 × 120	3NH3 420/3NH3 430	3	450	450
3NE1 333-2	690	gR	2	450	1.0	2 × 120		3	450	450
3NE1 333-3	690	gR	2	450	1.0	2 × 120		3	450	450
3NE1 334-0	690	gS	2	500	1.0	2 × 120	3	500	500	
3NE1 334-2	690	gR	2	500	1.0	2 × 120	3	500	500	
3NE1 334-3	690	gR	2	500	1.0	2 × 120	3	500	500	
3NE1 435-0	690	gS	3	560	1.0	2 × 150	3NH3 420/3NH3 430	3	560	560
3NE1 435-2	690	gR	3	560	1.0	2 × 150		3	560	560
3NE1 435-3	690	gR	3	560	1.0	2 × 150		3	560	560
3NE1 436-0	690	gS	3	630	1.0	2 × 185	3	630	630	
3NE1 436-2	690	gR	3	630	1.0	2 × 185	3	630	630	
3NE1 436-3	690	gR	3	630	1.0	2 × 185	3	630	630	
3NE1 437-0	690	gS	3	710	1.0	2 × (40 × 5)	3	710	710	
3NE1 437-1	600	gR	3	710	1.0	2 × (40 × 5)	3	690	690	
3NE1 437-2	690	gR	3	710	1.0	2 × (40 × 5)	3	710	710	
3NE1 437-3	690	gR	3	710	1.0	2 × (40 × 5)	3	710	710	
3NE1 438-0	690	gS	3	800	1.0	2 × (50 × 5)	3	800	800	
3NE1 438-1	600	gR	3	800	1.0	2 × (50 × 5)	3	750	750	
3NE1 438-2	690	gR	3	800	1.0	2 × (50 × 5)	3	800	800	
3NE1 438-3	690	gR	3	800	1.0	2 × (50 × 5)	3	800	800	
3NE1 447-2	690	gR	3	670	1.0	2 × (40 × 5)	3	670	670	
3NE1 447-3	690	gR	3	670	1.0	2 × (40 × 5)	3	670	670	
3NE1 448-2	690	gR	3	850	1.0	2 × (40 × 8)	3	850	850	
3NE1 448-3	690	gR	3	850	1.0	2 × (40 × 8)	3	850	850	

SITOR fuse links						\varnothing_{\min} Cu mm ²	LV HRC fuse bases			
Order No.	U_n V AC	Operational class	BG	I_n A	WL		Order No.	BG	I_{\max} A	I_{WL} A
3NE1 813-0	690	gS	000	16	1.0	1.5	3NH3 030/3NH4 030	00	16	16
3NE1 814-0	690	gS	000	20	1.0	2.5		00	20	20
3NE1 815-0	690	gS	000	25	1.0	4		00	25	25
3NE1 803-0	690	gS	000	35	1.0	6		00	35	35
3NE1 802-0	690	gS	000	40	1.0	10		00	40	40
3NE1 817-0	690	gS	000	50	1.0	10		00	50	50
3NE1 818-0	690	gS	000	63	1.0	16		00	63	63
3NE1 820-0	690	gS	000	80	1.0	25	00	80	80	
3NE3 221	1000	aR	1	100	0.95	35	3NH3 230/3NH4 230	1	100	95
3NE3 222	1000	aR	1	125	0.95	50		1	125	119
3NE3 224	1000	aR	1	160	1.0	70		1	160	160
3NE3 225	1000	aR	1	200	1.0	95	1	200	200	
3NE3 227	1000	aR	1	250	1.0	120	1	250	250	
3NE3 230-0B	1000	aR	1	315	0.95	185	3NH3 320/3NH3 330	2	305	290
3NE3 231	1000	aR	1	350	0.95	240		2	335	318
3NE3 232-0B	1000	aR	1	400	0.90	240	2	380	342	
3NE3 233	1000	aR	1	450	0.90	2 × 150	2	425	383	
3NE3 332-0B	1000	aR	2	400	1.0	240	3NH3 420/3NH3 430	3	400	400
3NE3 333	1000	aR	2	450	1.0	2 × 150		3	450	450
3NE3 334-0B	1000	aR	2	500	1.0	2 × 150		3	500	500
3NE3 335	1000	aR	2	560	1.0	2 × 185	3	560	560	
3NE3 336	1000	aR	2	630	1.0	2 × 185	3	630	630	
3NE3 337-8	900	aR	2	710	1.0	2 × 200	3	680	680	
3NE3 338-8	800	aR	2	800	0.95	2 × 200	3	700	665	
3NE3 340-8	690	aR	2	900	0.95	2 × 240	3	750	713	
3NE4 101	1000	gR	0	32	0.9	6	3NH3 120/3NH4 230	0/1	32	29
3NE4 102	1000	gR	0	40	0.9	10		0/1	40	36
3NE4 117	1000	gR	0	50	0.9	10		0/1	50	45
3NE4 118	1000	aR	0	63	0.9	16		0/1	63	57
3NE4 120	1000	aR	0	80	0.9	25		0/1	80	72
3NE4 121	1000	aR	0	100	0.9	35		0/1	100	93
3NE4 122	1000	aR	0	125	0.9	50		0/1	125	113
3NE4 124	1000	aR	0	160	0.9	70	0/1	160	144	
3NE4 327-0B	800	aR	2	250	0.85	120	3NH3 320/3NH3 330	2	240	204
3NE4 330-0B	800	aR	2	315	0.85	240		2	300	255
3NE4 333-0B	800	aR	2	450	0.85	2 × (30 × 5)	3NH3 420/3NH3 430	3	425	361
3NE4 334-0B	800	aR	2	500	0.85	2 × (30 × 5)		3	475	404
3NE4 337	800	aR	2	710	0.95	2 × (40 × 5)		3	630	599
3NE8 015-1	690	gR	00	25	0.95	4	3NH3 030/3NH4 030	00	25	24
3NE8 003-1	690	gR	00	35	0.95	6		00	35	33
3NE8 017-1	690	gR	00	50	0.90	10		00	50	45
3NE8 018-1	690	gR	00	63	0.95	16	00	63	60	
3NE8 020-1	690	aR	00	80	0.95	25	00	80	76	
3NE8 021-1	690	aR	00	100	0.95	35	3NH3 030/3NH4 030	00	100	95
3NE8 022-1	690	aR	00	125	0.95	50		00	125	119
3NE8 024-1	690	aR	00	160	0.95	70		00	160	152

 U_n = Rated voltage

BG = Size

 I_n = Rated current

WL = Varying load factor

 \varnothing_{\min} Cu = Required conductor cross-section Cu I_{\max} = Maximum permissible current I_{WL} = Maximum permissible current with varying load

Fuse systems

SITOR semiconductor fuses

LV HRC design, 3NC, 3NE

Load rating of SITOR fuse links with 3NP LV HRC fuse switch disconnectors

SITOR fuse links					Ø min Cu mm ²	3NP LV HRC fuse switch disconnectors															
Order No.	U _n V AC	BG	I _n A	WL		Add-on units				Busbar devices											
					Order No.	BG	I _{max} A	I _{WL}	Order No.	BG	I _{max} A	I _{WL}	Order No.	BG	I _{max} A	I _{WL}					
3NC2 423-3C	500	3	150	0.95	70	3NP54	3	145	125	3NP1 163	3	140	133		On request ¹⁾	--	--	--			
3NC2 425-3C	500	3	200	0.95	95		3	180	165		3	175	166			--	--	--			
3NC2 427-3C	500	3	250	0.95	120		3	225	205		3	220	209			--	--	--			
3NC2 428-3C	500	3	300	0.95	185		3	255	240		3	250	238			--	--	--			
3NC2 431-3C	500	3	350	0.95	240		3	330	295		3	320	304			--	--	--			
3NC2 432-3C	500	3	400	0.95	240	3	400	380	3	370	352	--	--	--							
3NC3 336-1	1000	3	630	0.85	480	3NP54	3	530	451	3NP1 163	3	500	425		--	--	--	--			
3NC3 337-1	1000	3	710	0.85	560		3	570	485		--	--	--			--	--	--			
3NC3 338-1	1000	3	800	0.85	640		3	630	535		--	--	--			--	--	--			
3NC3 340-1	1000	3	900	0.90	720		3	700	630		--	--	--			--	--	--			
3NC3 341-1	1000	3	1000	0.90	800		3	770	693		--	--	--			--	--	--			
3NC3 342-1	800	3	1100	0.90	880	3	800	720	--	--	--	--	--	--							
3NC3 343-1	800	3	1250	0.90	960	3	800	765	--	--	--	--	--	--							
3NC8 423-3C	660	3	150	0.85	70	3NP54	3	135	125	3NP1 163	3	120	102		On request ¹⁾	--	--	--			
3NC8 425-3C	660	3	200	0.85	95		3	180	165		3	160	136			--	--	--			
3NC8 427-3C	660	3	250	0.85	120		3	225	205		3	200	170			--	--	--			
3NC8 431-3C	660	3	350	0.85	240	3	300	275	3	270	230	--	--	--							
3NC8 434-3C	690	3	500	0.85	2 × 150	3	425	400	3	385	327	--	--	--							
3NC8 444-3C	600	3	1000	0.95	2 × (60×6)	3NP54	3	800	760	--	--	--	--	On request ¹⁾	--	--	--				
3NE1 020-2	690	00	80	1.0	25	3NP50	00	80	80	3NP1 133	00	80	80		On request ¹⁾	--	--	--			
3NE1 021-0	690	00	100	1.0	35		00	100	100		00	100	100			--	--	--			
3NE1 021-2	690	00	100	1.0	35		00	100	100		00	95	95			--	--	--			
3NE1 022-0	690	00	125	1.0	50		00	125	125		00	120	120			--	--	--			
3NE1 022-2	690	00	125	1.0	50	00	125	125	00	115	115	--	--	--							
3NE1 224-0	690	1	160	1.0	70	3NP52	1	160	160	3NP1 143	1	160	160	3NP1 153	2	160	160	On request ¹⁾	--	--	--
3NE1 224-2	690	1	160	1.0	70		1	160	160		1	150	150		2	160	160		--	--	--
3NE1 224-3	690	1	160	1.0	70		1	160	160		1	150	150		2	160	160		--	--	--
3NE1 225-0	690	1	200	1.0	95	1	200	200	1	190	190	2	200	200	--	--	--				
3NE1 225-2	690	1	200	1.0	95	1	200	200	1	180	180	2	190	190	--	--	--				
3NE1 225-3	690	1	200	1.0	95	1	200	200	1	180	180	2	190	190	--	--	--				
3NE1 227-0	690	1	250	1.0	120	1	250	250	1	235	235	2	250	250	--	--	--				
3NE1 227-2	690	1	250	1.0	120	1	250	250	1	220	220	2	235	235	--	--	--				
3NE1 227-3	690	1	250	1.0	120	1	250	250	1	220	220	2	235	235	--	--	--				
3NE1 230-0	690	1	315	1.0	2 × 70	3NP53	2	315	315	3NP1 153	2	290	290		On request ¹⁾	--	--	--			
3NE1 230-2	690	1	315	1.0	2 × 70		2	315	315		2	278	278			--	--	--			
3NE1 230-3	690	1	315	1.0	2 × 70		2	315	315		2	278	278			--	--	--			
3NE1 331-0	690	2	350	1.0	2 × 95	3NP53	2	350	350	3NP1 153	2	315	315	3NP1 163	3	340	340	On request ¹⁾	--	--	--
3NE1 331-2	690	2	350	1.0	2 × 95		2	350	350		2	300	300		3	330	330		--	--	--
3NE1 331-3	690	2	350	1.0	2 × 95		2	350	350		2	300	300		3	330	330		--	--	--
3NE1 332-0	690	2	400	1.0	2 × 95	2	400	400	2	340	340	3	380	380	--	--	--				
3NE1 332-2	690	2	400	1.0	2 × 95	2	400	400	2	328	328	3	370	370	--	--	--				
3NE1 332-3	690	2	400	1.0	2 × 95	2	400	400	2	328	328	3	370	370	--	--	--				
3NE1 333-0	690	2	450	1.0	2 × 120	3NP54	3	450	450	3NP1 163	3	450	450		On request ¹⁾	--	--	--			
3NE1 333-2	690	2	450	1.0	2 × 120		3	450	450		3	430	430			--	--	--			
3NE1 333-3	690	2	450	1.0	2 × 120		3	450	450		3	430	430			--	--	--			
3NE1 334-0	690	2	500	1.0	2 × 120	3	500	500	3	500	500	--	--	--							
3NE1 334-2	690	2	500	1.0	2 × 120	3	500	500	3	475	475	--	--	--							
3NE1 334-3	690	2	500	1.0	2 × 120	3	500	500	3	475	475	--	--	--							
3NE1 435-0	690	3	560	1.0	2 × 150	3NP54	3	560	560	3NP1 163	3	560	560		On request ¹⁾	--	--	--			
3NE1 435-2	690	3	560	1.0	2 × 150		3	560	560		3	555	555			--	--	--			
3NE1 435-3	690	3	560	1.0	2 × 150		3	560	560		3	555	555			--	--	--			
3NE1 436-0	690	3	630	1.0	2 × 185	3	630	630	3	630	630	--	--	--							
3NE1 436-2	690	3	630	1.0	2 × 185	3	625	625	3	620	620	--	--	--							
3NE1 436-3	690	3	630	1.0	2 × 185	3	625	625	3	620	620	--	--	--							
3NE1 437-0	690	3	710	1.0	2 × (40×5)	3	710	710	--	--	--	--	--	--							
3NE1 437-1	600	3	710	1.0	2 × (40×5)	3	690	690	--	--	--	--	--	--							
3NE1 437-2	690	3	710	1.0	2 × (40×5)	3	685	685	--	--	--	--	--	--							
3NE1 437-3	690	3	710	1.0	2 × (40×5)	3	685	685	--	--	--	--	--	--							
3NE1 438-0	690	3	800	1.0	2 × (50×5)	3NP54	3	800	800	--	--	--	--		On request ¹⁾	--	--	--			
3NE1 438-1	600	3	800	1.0	2 × (50×5)		3	750	750							--	--	--	--	--	--
3NE1 438-2	690	3	800	1.0	2 × (50×5)		3	770	770							--	--	--	--	--	--
3NE1 438-3	690	3	800	1.0	2 × (50×5)	3	770	770	--	--	--	--	--	--							
3NE1 447-2	690	3	670	1.0	2 × (40×5)	3	655	655	--	--	--	--	--	--							
3NE1 447-3	690	3	670	1.0	2 × (40×5)	3	655	655	--	--	--	--	--	--							
3NE1 448-2	690	3	850	1.0	2 × (40×8)	3	820	820	--	--	--	--	--	--							
3NE1 448-3	690	3	850	1.0	2 × (40×8)	3	820	820	--	--	--	--	--	--							

SITOR fuse links					Ø min Cu mm ²	3NP LV HRC fuse switch disconnectors																			
Order No.	U _n V AC	BG	I _n A	WL		Add-on units				Busbar devices															
					Order No.	BG	I _{max} A	I _{WL}	Order No.	BG	I _{max} A	I _{WL}	Order No.	BG	I _{max} A	I _{WL}									
3NE1 813-0	690 000		16	1.0	1.5	3NP53	000	16	16	3NP1 123	000	16	16	3NP1 133	00	16	16	On request ¹⁾	--	--	--				
3NE1 814-0	690 000		20	1.0	2.5		000	20	20		000	20	20		00	20	20		--	--	--				
3NE1 815-0	690 000		25	1.0	4		000	25	25		000	25	25		00	25	25		--	--	--				
3NE1 803-0	690 000		35	1.0	6		000	35	35		000	35	35		00	35	35		--	--	--				
3NE1 802-0	690 000		40	1.0	10		000	40	40		000	40	40		00	40	40		--	--	--				
3NE1 817-0	690 000		50	1.0	10	000	50	50	000	50	50	00	50	50	--	--	--								
3NE1 818-0	690 000		63	1.0	16	000	63	63	000	63	63	00	63	63	--	--	--								
3NE1 820-0	690 000		80	1.0	25	000	80	80	000	80	80	00	80	80	--	--	--								
3NE3 221	1000 1		100	0.95	35	3NP52	1	95	90	3NP1 143	1	88	84	3NP1 153	2	95	90	On request ¹⁾	--	--	--				
3NE3 222	1000 1		125	0.95	50		1	110	110		1	102	97		2	110	105		--	--	--				
3NE3 224	1000 1		160	1.0	70		1	140	140		1	130	130		2	140	140		--	--	--				
3NE3 225	1000 1		200	1.0	95		1	175	175		1	163	163		2	175	175		--	--	--				
3NE3 227	1000 1		250	1.0	120		1	210	210		1	195	195		2	210	210		--	--	--				
3NE3 230-0B	1000 1		315	0.95	185	3NP53	2	285	280	3NP1 153	2	270	257					On request ¹⁾	--	--	--				
3NE3 231	1000 1		350	0.95	240		2	310	300		2	290	276						--	--	--				
3NE3 232-0B	1000 1		400	0.90	240		2	330	320		2	320	288						--	--	--				
3NE3 233	1000 1		450	0.90	2x 150		2	360	340		2	360	324						--	--	--				
3NE3 332-0B	1000 2		400	1.0	240		3NP54	3	360		345	3NP1 153	2		330	330	3NP1 163		3	360	360	On request ¹⁾	--	--	--
3NE3 333	1000 2		450	1.0	2x 150	3		400	385	2	375		375					--	--	--					
3NE3 334-0B	1000 2		500	1.0	2x 150	3		450	450	2	420		420					--	--	--					
3NE3 335	1000 2		560	1.0	2x 185	3		510	510	2	475		475					--	--	--					
3NE3 336	1000 2		630	1.0	2x 185	3		580	580	2	560		560					--	--	--					
3NE3 337-8	900 2		710	1.0	2x 200	3	630	630	2	580	580				--	--	--								
3NE3 338-8	800 2		800	0.95	2x 200	3	630	630	2	605	575				--	--	--								
3NE3 340-8	690 2		900	0.95	2x 200	3	630	630	2	630	599				--	--	--								
3NE4 101	1000 0		32	0.9	6	3NP52	1	32	29	3NP1 143	1	30	27					On request ¹⁾	--	--	--				
3NE4 102	1000 0		40	0.9	10		1	40	36		1	35	32						--	--	--				
3NE4 117	1000 0		50	0.9	10		1	50	45		1	42	38						--	--	--				
3NE4 118	1000 0		63	0.9	16		1	63	57		1	55	50						--	--	--				
3NE4 120	1000 0		80	0.9	25		1	80	72		1	71	64						--	--	--				
3NE4 121	1000 0		100	0.9	35		1	95	86		1	84	76						--	--	--				
3NE4 122	1000 0		125	0.9	50		1	120	108		1	107	96						--	--	--				
3NE4 124	1000 0		160	0.9	70		1	150	135		1	134	121						--	--	--				
3NE4 327-0B	800 2		250	0.85	120		3NP53/ 3NP54	2/ 3	210/ 220		205/ 210	3NP1 153	2		195	166	3NP1 163		3	215	183	On request ¹⁾	--	--	--
3NE4 330-0B	800 2		315	0.85	240			2/ 3	270/ 285		255/ 265		2		240	204			3	270	230		--	--	--
3NE4 333-0B	800 2		450	0.85	2x (30x5)	2/ 3		400/ 420	370/ 380	3	370		315					--	--	--					
3NE4 334-0B	800 2		500	0.85	2x (30x5)	3NP54	3	450	400	3	410	349				On request ¹⁾	--	--	--						
3NE4 337	800 2		710	0.95	2x (40x5)		3	600	570	3	540	513					--	--	--						
3NE8 015-1	690 00		25	0.95	4	3NP50	00	25	24	3NP1 133	00	25	24					On request ¹⁾	--	--	--				
3NE8 003-1	690 00		35	0.95	6		00	33	31		00	32	30						--	--	--				
3NE8 017-1	690 00		50	0.90	10		00	45	41		00	43	39						--	--	--				
3NE8 018-1	690 00		63	0.95	16		00	54	51		00	52	49						--	--	--				
3NE8 020-1	690 00		80	0.95	25		00	68	65		00	65	62						--	--	--				
3NE8 021-1	690 00		100	0.95	35	3NP50	00	89	85	3NP1 133	00	85	81					On request ¹⁾	--	--	--				
3NE8 022-1	690 00		125	0.95	50		00	106	101		00	100	95						--	--	--				
3NE8 024-1	690 00		160	0.95	70		00	130	124		00	120	114						--	--	--				

U_n = Rated voltage

BG = Size

I_n = Rated current

WL = Varying load factor

Ø_{min} Cu = Required conductor cross-section CuI_{max} = Maximum permissible currentI_{WL} = Maximum permissible current with varying load¹⁾ Available soon

Fuse systems

SITOR semiconductor fuses

LV HRC design, 3NC, 3NE

Load rating of SITOR fuse links with 3KL/3KM LV HRC fuse switch disconnectors with fuses

SITOR fuse links					Ø min Cu mm ²	3KL /3KM switch disconnectors with fuses											
Order No.	U _n V AC	BG	I _n A	WL		3KL... add-on devices				3KM... busbar devices							
					Order No.	BG	I _{max} A	I _{WL}	Order No.	BG	I _{max} A	I _{WL}	Order No.	BG	I _{max} A	I _{WL}	
3NC2 423-3C	500	3	150	0.95	70	3KL61	3	145	138	3KL62	3	150	143	--	--	--	--
3NC2 425-3C	500	3	200	0.95	95		3	180	171		3	190	181				
3NC2 427-3C	500	3	250	0.95	120		3	225	214		3	240	228				
3NC2 428-3C	500	3	300	0.95	185		3	255	242		3	270	257				
3NC2 431-3C	500	3	350	0.95	240		3	330	314		3	345	328				
3NC2 432-3C	500	3	400	0.95	240		3	400	380		3	400	380				
3NC3 336-1	1000	3	630	0.85	480	--	--	--	--	3KL62	3	500	425	--	--	--	--
3NC3 337-1	1000	3	710	0.85	560						3	540	459				
3NC3 338-1	1000	3	800	0.85	640						3	600	510				
3NC3 340-1	1000	3	900	0.90	720						3	650	585				
3NC3 341-1	1000	3	1000	0.90	800						3	720	648				
3NC3 342-1	800	3	1100	0.90	880						3	800	720				
3NC3 343-1	800	3	1250	0.90	960						3	800	720				
3NC8 423-3C	660	3	150	0.85	70	3KL61	3	135	115	3KL62	3	140	119	--	--	--	--
3NC8 425-3C	660	3	200	0.85	95		3	180	153		3	190	162				
3NC8 427-3C	660	3	250	0.85	120		3	225	191		3	240	204				
3NC8 431-3C	660	3	350	0.85	240		3	300	255		3	315	268				
3NC8 434-3C	660	3	500	0.85	2 × 150		3	425	361		3	450	383				
3NC8 444-3C	600	3	1000	0.95	2 × (60 × 6)		3	800	800		3	630	630				
3NE1 020-2	690	00	80	1.0	25	3KL52	00	80	80	3KL53	00	80	80	3KM52	00	80	80
3NE1 021-0	690	00	100	1.0	35		00	100	100		00	100	100		00	100	100
3NE1 021-2	690	00	100	1.0	35		00	100	100		00	100	100		00	100	100
3NE1 022-0	690	00	125	1.0	125		00	125	125		00	125	125		00	125	125
3NE1 022-2	690	00	125	1.0	125		00	125	125		00	125	125		00	125	125
3NE1 224-0	690	1	160	1.0	70	3KL55	1	160	160	3KL57	2	160	160	3KM55	1	160	160
3NE1 224-2	690	1	160	1.0	70		1	160	160		2	160	160		1	160	160
3NE1 224-3	690	1	160	1.0	70		1	160	160		2	160	160		1	160	160
3NE1 225-0	690	1	200	1.0	95		1	200	200		2	200	200		1	200	200
3NE1 225-2	690	1	200	1.0	95		1	200	200		2	200	200		1	200	200
3NE1 225-3	690	1	200	1.0	95		1	200	200		2	200	200		1	200	200
3NE1 227-0	690	1	250	1.0	120		1	250	250		2	250	250		1	250	250
3NE1 227-2	690	1	250	1.0	120		1	245	245		2	250	250		1	245	245
3NE1 227-3	690	1	250	1.0	120		1	245	245		2	250	250		1	245	245
3NE1 230-0	690	1	315	1.0	2 × 70	3KL57	2	315	315	--	--	--	--	3KM57	2	315	315
3NE1 230-2	690	1	315	1.0	2 × 70		2	280	280		--	--	--		2	280	280
3NE1 230-3	690	1	315	1.0	2 × 70		2	280	280		--	--	--		2	280	280
3NE1 331-0	690	2	350	1.0	2 × 95	3KL57	2	330	330	3KL61	3	350	350	3KM57	2	330	330
3NE1 331-2	690	2	350	1.0	2 × 95		2	300	300		3	350	350		2	300	300
3NE1 331-3	690	2	350	1.0	2 × 95		2	300	300		3	350	350		2	300	300
3NE1 332-0	690	2	400	1.0	2 × 95		2	375	375		3	400	400		2	375	375
3NE1 332-2	690	2	400	1.0	2 × 95		2	340	340		3	400	400		2	340	340
3NE1 332-3	690	2	400	1.0	2 × 95		2	340	340		3	400	400		2	340	340
3NE1 333-0	690	2	450	1.0	2 × 120	3KL61	3	450	450	3KL62	3	450	450		2	400	400
3NE1 333-2	690	2	450	1.0	2 × 120		3	450	450		3	450	500		2	325	325
3NE1 333-3	690	2	450	1.0	2 × 120		3	450	450		3	450	500		2	325	325
3NE1 334-0	690	2	500	1.0	2 × 120		3	500	500		3	500	500		2	400	400
3NE1 334-2	690	2	500	1.0	2 × 120		3	500	500		3	500	500		2	350	350
3NE1 334-3	690	2	500	1.0	2 × 120		3	500	500		3	500	500		2	350	350
3NE1 435-0	690	3	560	1.0	2 × 150	3KL61	3	560	560	3KL62	3	560	560	--	--	--	--
3NE1 435-2	690	3	560	1.0	2 × 150		3	560	560		3	560	560		--	--	--
3NE1 435-3	690	3	560	1.0	2 × 150		3	560	560		3	560	560		--	--	--
3NE1 436-0	690	3	630	1.0	2 × 185		3	630	630		3	630	630		--	--	--
3NE1 436-2	690	3	630	1.0	2 × 185		3	615	615		3	630	630		--	--	--
3NE1 436-3	690	3	630	1.0	2 × 185		3	615	615		3	630	630		--	--	--
3NE1 437-0	690	3	710	1.0	2 × (40 × 5)		3	630	630		3	710	710		--	--	--
3NE1 437-1	600	3	710	1.0	2 × (40 × 5)		3	630	630		3	710	710		--	--	--
3NE1 437-2	690	3	710	1.0	2 × (40 × 5)		3	630	630		3	700	700		--	--	--
3NE1 437-3	690	3	710	1.0	2 × (40 × 5)		3	630	630		3	700	700		--	--	--
3NE1 438-0	690	3	800	1.0	2 × (50 × 5)	3KL61	3	630	630	3KL62	3	800	800	--	--	--	--
3NE1 438-1	600	3	800	1.0	2 × (50 × 5)		3	630	630		3	800	800		--	--	--
3NE1 438-2	690	3	800	1.0	2 × (50 × 5)		3	630	630		3	760	760		--	--	--
3NE1 438-3	690	3	800	1.0	2 × (50 × 5)		3	630	630		3	760	760		--	--	--
3NE1 447-2	690	3	670	1.0	2 × (40 × 5)		3	630	630		3	670	670		--	--	--
3NE1 447-3	690	3	670	1.0	2 × (40 × 5)		3	630	630		3	670	670		--	--	--
3NE1 448-2	690	3	850	1.0	2 × (40 × 8)		3	630	630		3	790	790		--	--	--
3NE1 448-3	690	3	850	1.0	2 × (40 × 8)		3	630	630		3	790	790		--	--	--

SITOR fuse links					3KL /3KM switch disconnectors with fuses																
Order No.	U_n V AC	BG	I_n A	WL	\emptyset min Cu mm ²	3KL... add-on devices								3KM... busbar devices							
						Order No.	BG	I_{max} A	I_{WL}	Order No.	BG	I_{max} A	I_{WL}	Order No.	BG	I_{max} A	I_{WL}	Order No.	BG	I_{max} A	I_{WL}
3NE1 813-0	690 000		16	1.0	1.5	3KL50	00	16	16	3KL52	00	16	16	3KM50	00	16	16	3KM52	00	16	16
3NE1 814-0	690 000		20	1.0	2.5		00	20	20		00	20	20		00	20	20		00	20	20
3NE1 815-0	690 000		25	1.0	4		00	25	25		00	25	25		00	25	25		00	25	25
3NE1 803-0	690 000		35	1.0	6		00	35	35		00	35	35		00	35	35		00	35	35
3NE1 802-0	690 000		40	1.0	10		00	40	40		00	40	40		00	40	40		00	40	40
3NE1 817-0	690 000		50	1.0	10		00	50	50		00	50	50		00	50	50		00	50	50
3NE1 818-0	690 000		63	1.0	16		00	63	63		00	63	63		00	63	63		00	63	63
3NE1 820-0	690 000		80	1.0	25	3KL52	00	80	80	--	--	--	--	3KM52	00	80	80	--	--	--	--
3NE3 221	1000 1		100	0.95	35	3KL55	1	90	86	3KL57	2	95	90	3KM55	1	90	86	3KM57	2	95	90
3NE3 222	1000 1		125	0.95	50		1	110	105		2	115	109		1	110	105		2	115	109
3NE3 224	1000 1		160	1.0	70		1	140	140		2	150	150		1	140	140		2	150	150
3NE3 225	1000 1		200	1.0	95		1	175	175		2	180	180		1	175	175		2	180	180
3NE3 227	1000 1		250	1.0	120		1	210	210		2	220	220		1	210	210		2	220	220
3NE3 230-0B	1000 1		315	0.95	185	3KL57	2	240	228	--	--	--	--	3KM57	2	240	228	--	--	--	--
3NE3 231	1000 1		350	0.95	240		2	265	252		--	--	--		2	265	252		--	--	--
3NE3 232-0B	1000 1		400	0.90	240		2	290	261		--	--	--		2	290	261		--	--	--
3NE3 233	1000 1		450	0.90	2x 150		2	320	288		--	--	--		2	320	288		--	--	--
3NE3 332-0B	1000 2		400	1.0	240	3KL61	3	340	340	3KL62	3	360	360	3KM57	2	290	290	--	--	--	--
3NE3 333	1000 2		450	1.0	2x 150		3	380	380		3	400	400		2	320	320		--	--	--
3NE3 334-0B	1000 2		500	1.0	2x 150		3	440	440		3	470	470		2	360	360		--	--	--
3NE3 335	1000 2		560	1.0	2x 185		3	500	500		3	530	530		2	400	400		--	--	--
3NE3 336	1000 2		630	1.0	2x 185		3	540	540		3	580	580		2	400	400		--	--	--
3NE3 337-8	900 2		710	1.0	2x 200		3	600	600		3	640	640		2	400	400		--	--	--
3NE3 338-8	800 2		800	0.95	2x 200		3	630	630		3	720	680		2	400	400		--	--	--
3NE3 340-8	690 2		900	0.95	2x 200		3	630	630		3	800	750		2	400	400		--	--	--
3NE4 101	1000 0		32	0.9	6	3KL55	1	32	29	--	--	--	--	3KM55	1	32	29	--	--	--	--
3NE4 102	1000 0		40	0.9	10		1	40	36		--	--	--		1	40	36		--	--	--
3NE4 117	1000 0		50	0.9	10		1	50	45		--	--	--		1	50	45		--	--	--
3NE4 118	1000 0		63	0.9	16		1	63	57		--	--	--		1	63	57		--	--	--
3NE4 120	1000 0		80	0.9	25		1	80	72		--	--	--		1	80	72		--	--	--
3NE4 121	1000 0		100	0.9	35		1	95	86		--	--	--		1	95	86		--	--	--
3NE4 122	1000 0		125	0.9	50		1	120	108		--	--	--		1	120	108		--	--	--
3NE4 124	1000 0		160	0.9	70		1	150	135		--	--	--		1	150	135		--	--	--
3NE4 327-0B	800 2		250	0.85	120	3KL57	2	175	149	3KL61	3	200	170	3KM57	2	175	149	--	--	--	--
3NE4 330-0B	800 2		315	0.85	240		2	230	196		3	260	221		2	230	196		--	--	--
3NE4 333-0B	800 2		450	0.85	2x (30x5)		2	340	289		3	370	315		2	340	289		--	--	--
3NE4 334-0B	800 2		500	0.85	2x (30x5)	3KL61	3	425	361	3KL62	3	450	375		2	380	323		--	--	--
3NE4 337	800 2		710	0.95	2x (40x5)		3	600	570		3	630	600		2	400	400		--	--	--
3NE8 015-1	690 00		25	0.95	4	3KL50	00	25	24	3KL52	00	25	24	3KM50	00	25	24	3KM52	00	25	24
3NE8 003-1	690 00		35	0.95	6		00	33	31		00	35	33		00	33	31		00	35	33
3NE8 017-1	690 00		50	0.90	10		00	45	41		00	50	45		00	45	41		00	50	45
3NE8 018-1	690 00		63	0.95	16		00	54	51		00	60	57		00	54	51		00	60	57
3NE8 020-1	690 00		80	0.95	25	3KL52	00	68	65	3KL53	00	68	65	3KM52	00	68	65	3KM53	00	68	65
3NE8 021-1	690 00		100	0.95	35	3KL52	00	89	85	3KL53	00	89	85	3KM52	00	89	85	3KM53	00	89	85
3NE8 022-1	690 00		125	0.95	50		00	106	101		00	106	101		00	106	101		00	106	101
3NE8 024-1	690 00		160	0.95	70		00	130	124		00	130	124		00	130	124		00	130	124

 U_n = Rated voltage

BG = Size

 I_n = Rated current

WL = Varying load factor

 \emptyset_{min} Cu = Required conductor cross-section Cu I_{max} = Maximum permissible current I_{WL} = Maximum permissible current with varying load

Fuse systems

SITOR semiconductor fuses

LV HRC design, 3NC, 3NE

Dimensional drawings

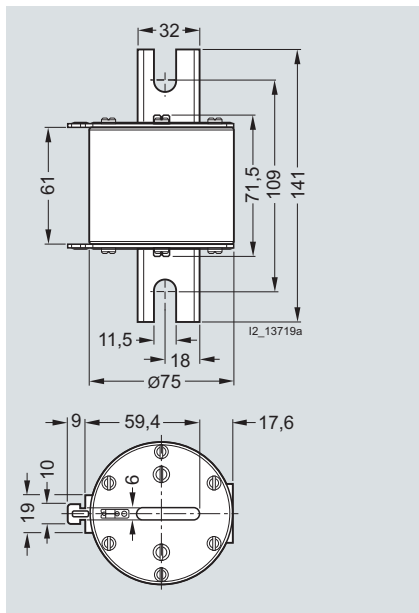

3NC2 4...-0C, 3NC8 4...-0C

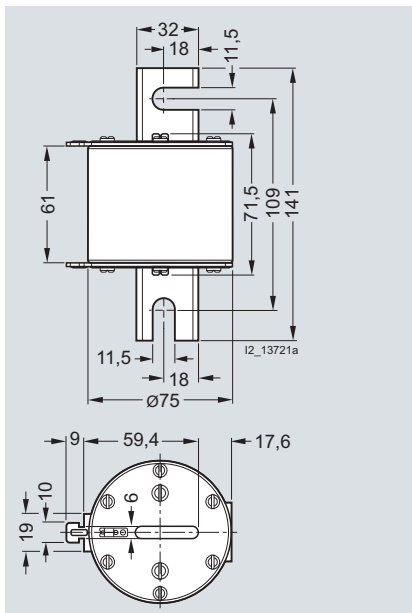

3NC2 4...-3C, 3NC8 4...-3C

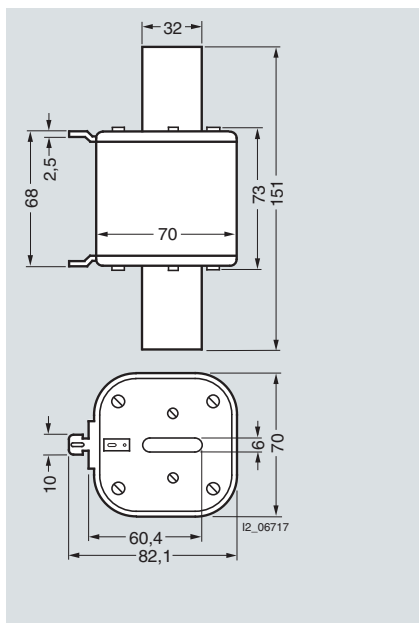

3NE1 43...-0, 3NE1 43...-1

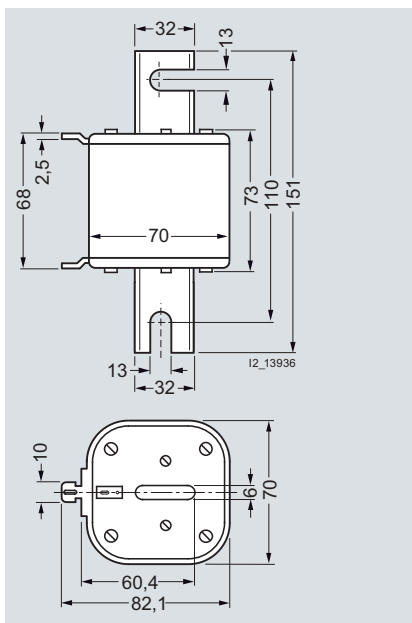

3NE1 4...-3

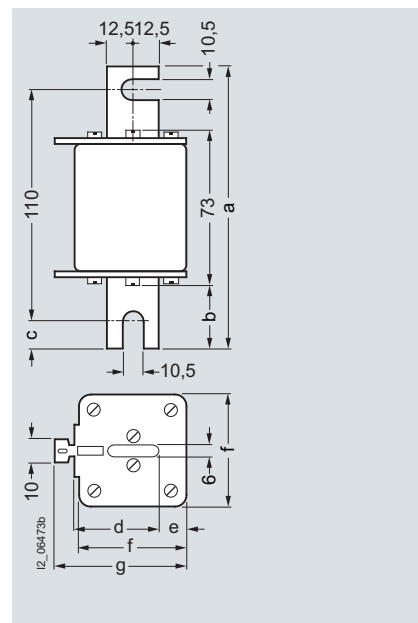

3NE1 2...-3, 3NE1 3...-3

Type	Dimensions (mm)						
	a	b	c	d	e	f	g
3NE1 2...-3	135	31	12.5	40.5	13.5	52	63.5
3NE1 3...-3	149	38	19.5	47.5	15	60	72

Fuse systems

SITOR semiconductor fuses

LV HRC design, 3NC, 3NE

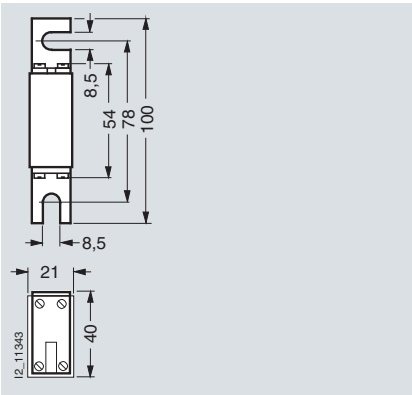

3NE8 7..-1

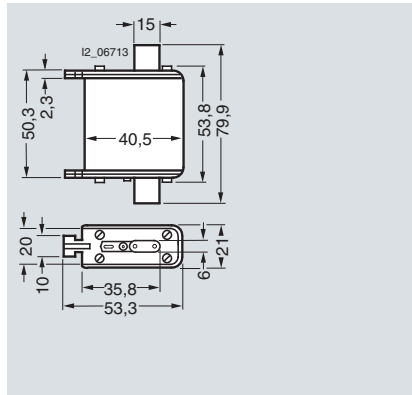

3NE1 8..-0

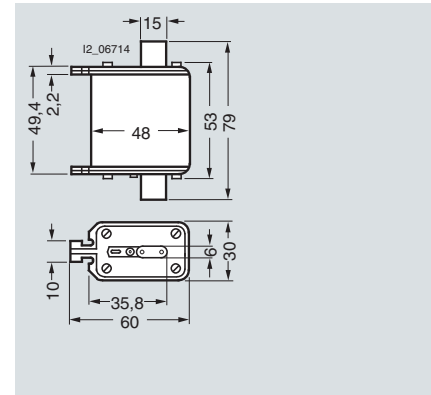

3NE1 02..-0, 3NE1 02..-2, 3NE8 0..-1

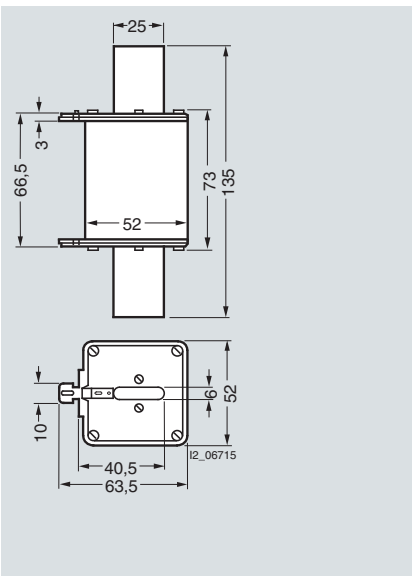

3NE1 2..-0, 3NE1 2..-2

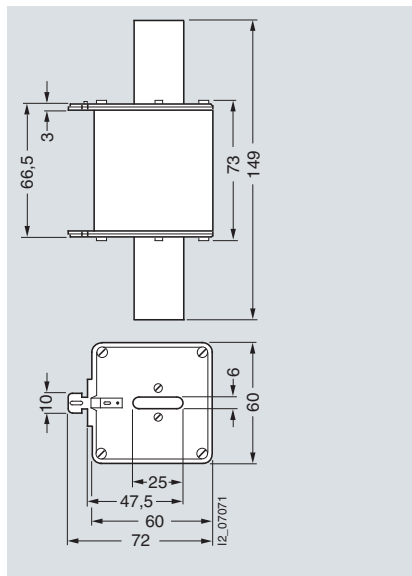

3NE1 33..-0, 3NE1 33..-2

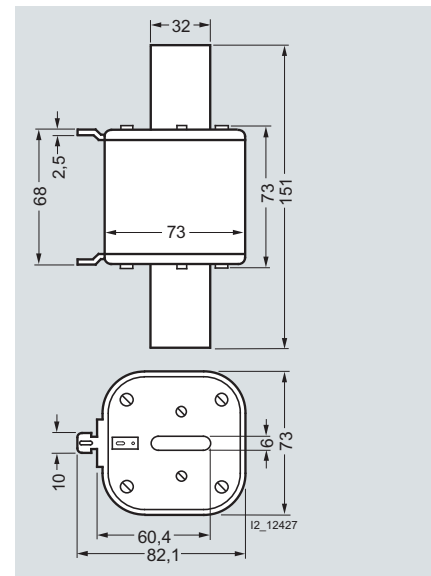

3NE1 4..-2

Fuse systems SITOR semiconductor fuses

LV HRC design, 3NC, 3NE

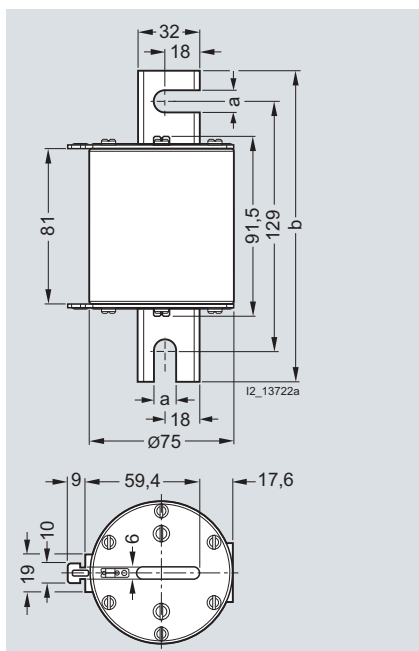

3NE3 ...-0C, 3NE3 6...-1C

Type	Dimensions (mm)	
	a	b
3NE3 ...-0C	11.5	161
3NE3 6...-1C	13	171

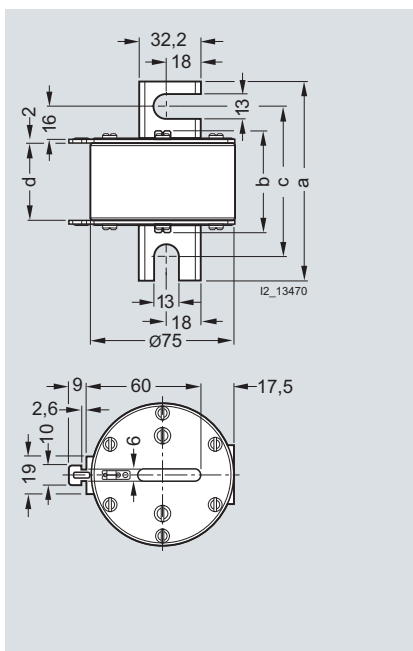

3NC3 4...-1

Type	Dimensions (mm)			
	a	b	c	d
3NC3 4...-1	139	72	108	61

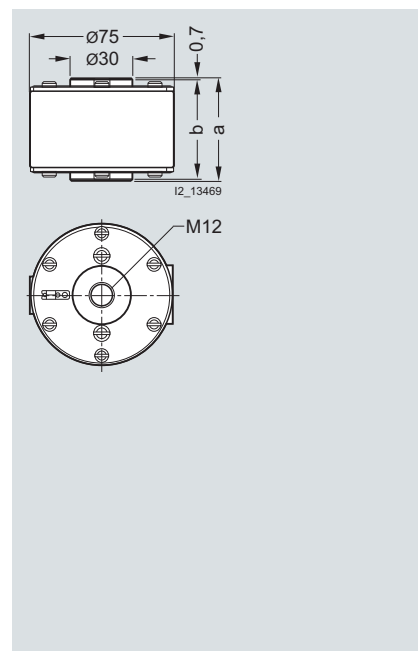

3NC3 4...-6

Type	Dimensions (mm)	
	a	b
3NC3 4...-6	73	71

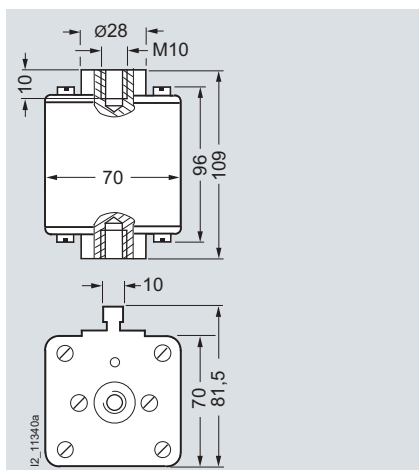

3NE3 635-6

Fuse systems

SITOR semiconductor fuses

LV HRC design, 3NC, 3NE

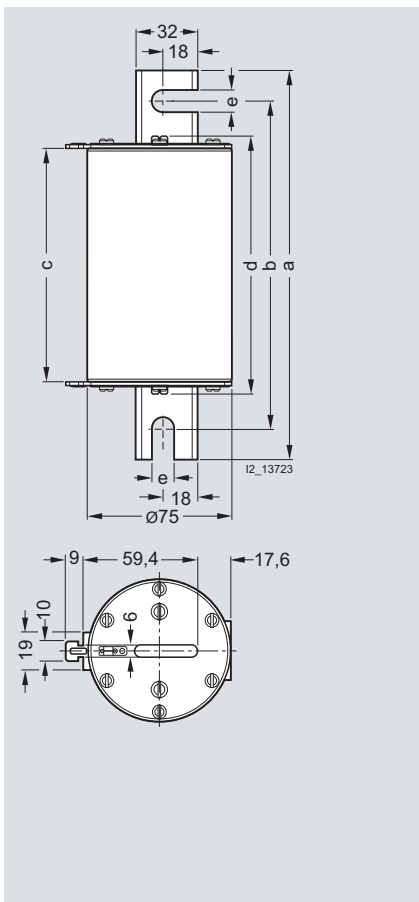

3NE5 6...-0C

Type	Dimensions (mm)				
	a	b	c	d	e
3NE5 6...-0C	201	169	121	131.5	11.5

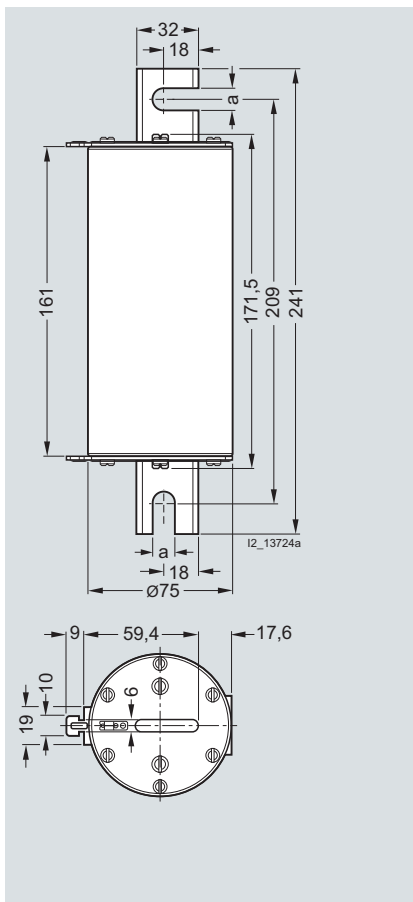

3NE5 4...-0C, 3NE5 4...-1C;
3NE7...-0C, 3NE7...-1C

Type	Dimensions (mm)
	a
3NE5 4...-0C	11.5
3NE5 4...-1C	13
3NE7...-0C	11.5
3NE7...-1C	13

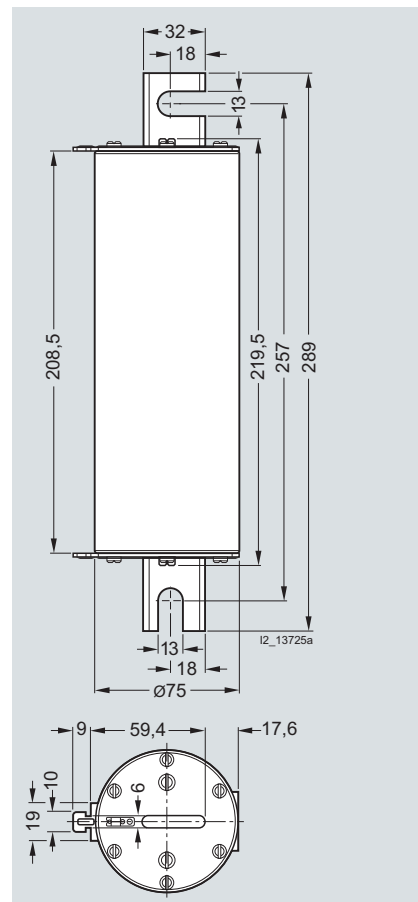

3NE9 6...-1C

Fuse systems SITOR semiconductor fuses

LV HRC design, 3NC, 3NE

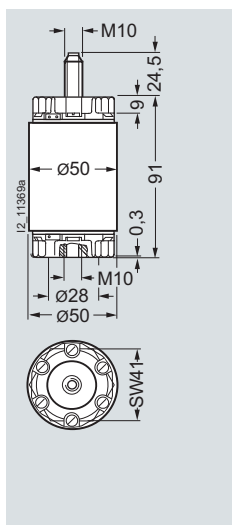

3NC5 531

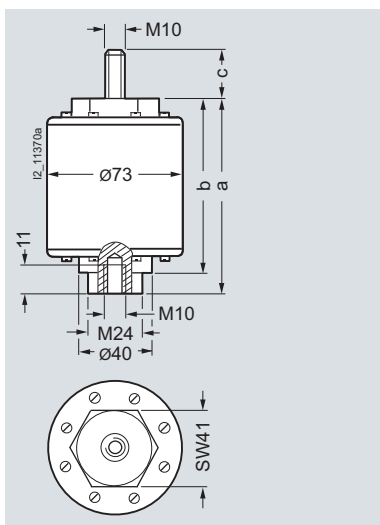

3NC5 8..

Type	Dimensions (mm)		
	a	b	c
3NC5 838	98	88.5	25
3NC5 841	98	88.5	25
3NC5 840	119	109.5	20.5

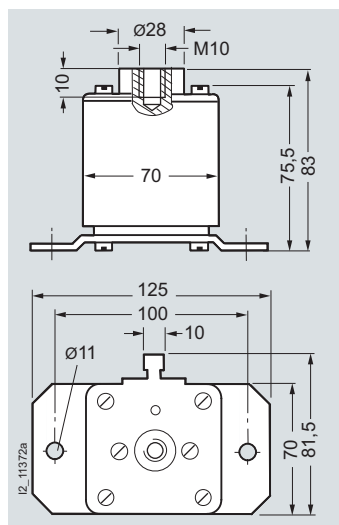

3NE6 4..-7, 3NE9 4..-7

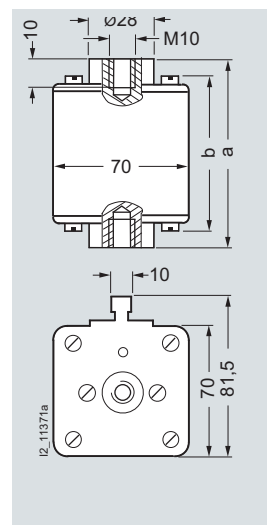

3NE6 4.., 3NE9 4..

Type	Dimensions (mm)	
	a	b
3NE6 437	89	76
3NE9 450	89	76
3NE9 440-6	89	76
3NE6 444	99	86

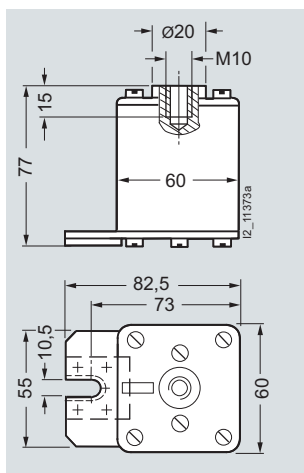

3NE3...-5

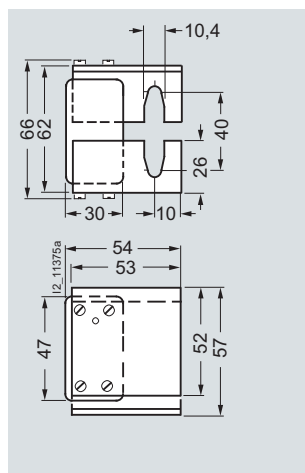

3NE4 1..-5

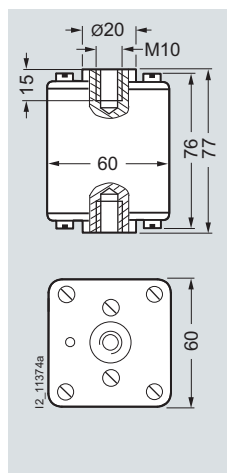

3NE4 3..-6B, 3NE4 337-6

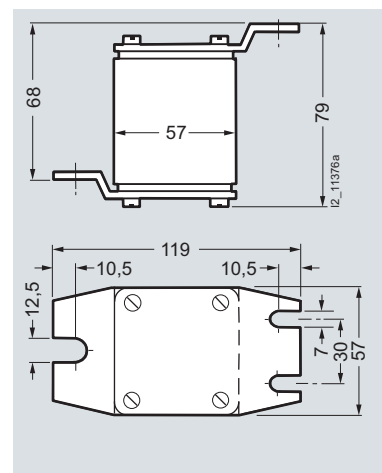

3NC7 3..-2

Fuse systems

SITOR semiconductor fuses

LV HRC design, 3NC, 3NE

Characteristic curves

Series 3NC2 4..

Size: 3
 Operational class: gR or aR
 Rated voltage: 500 V AC
 Rated current: 150 ... 400 A

Time/current characteristics diagram

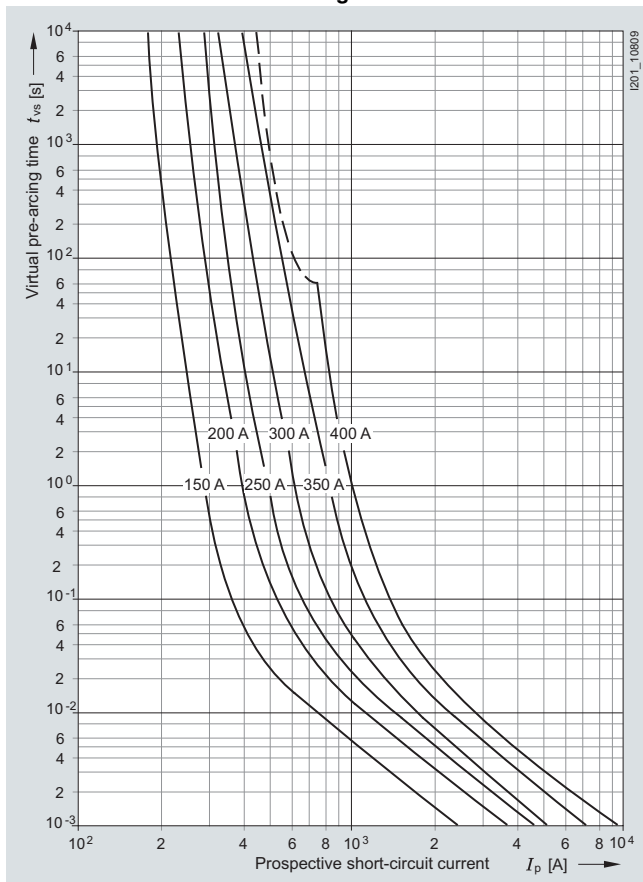

Let-through characteristics (current limitation at 50 Hz)

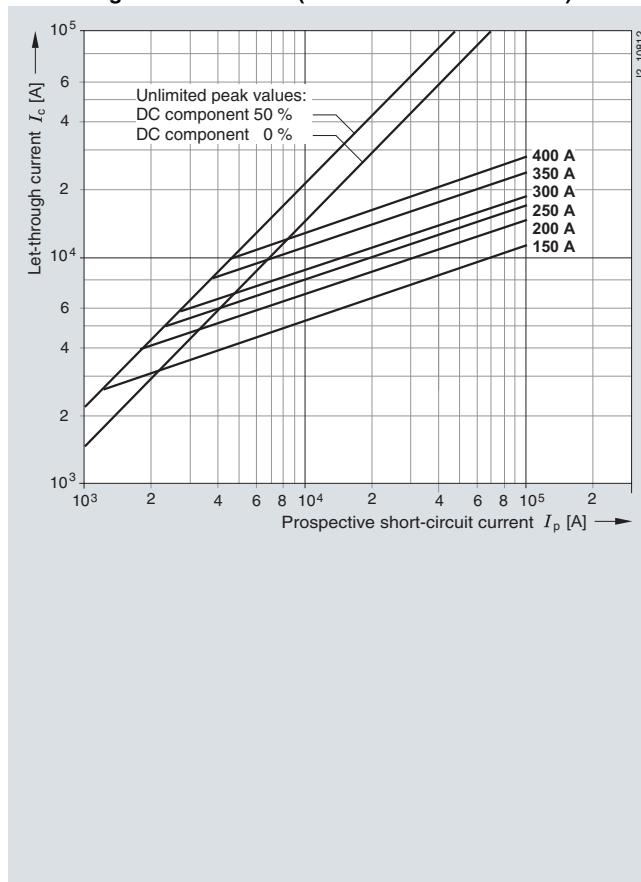

Correction factor k_A for breaking I^2t value

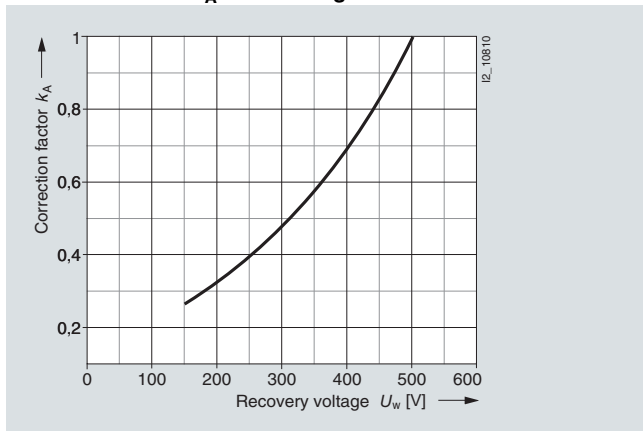

Peak arc voltage

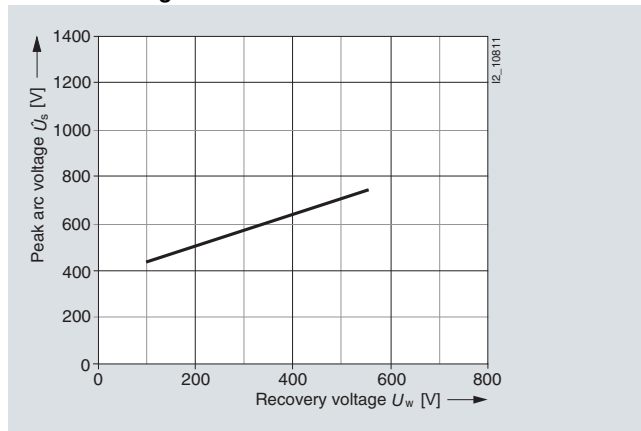

Fuse systems

SITOR semiconductor fuses

LV HRC design, 3NC, 3NE

3NC3 2 series

Size: 3
 Operational class: aR
 Rated voltage: 690 V AC (630 ... 1250 A),
 500 V AC (1400 ... 1600 A)
 Rated current: 630 ... 1600 A

Time/current characteristics diagram

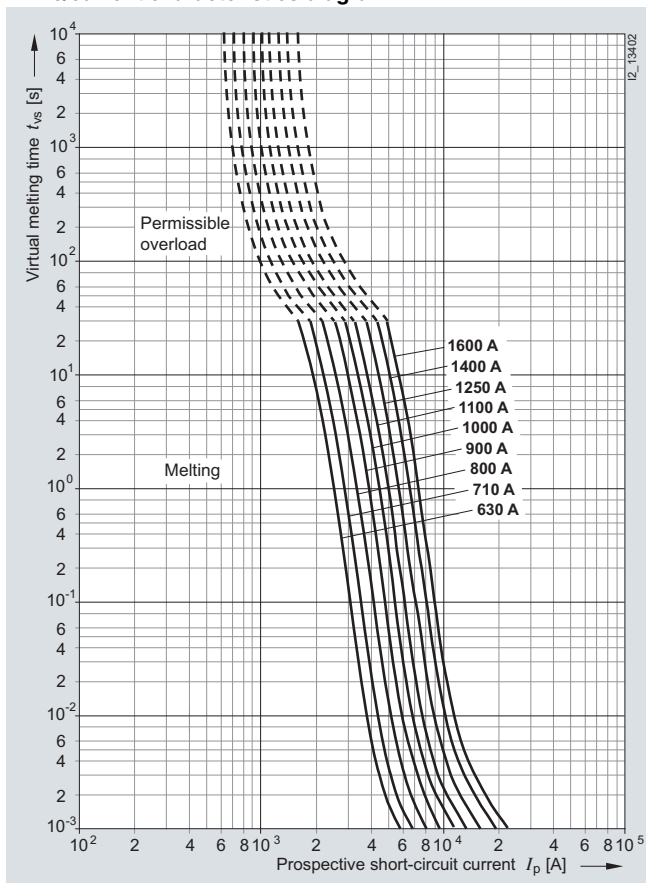

Let-through characteristic curves

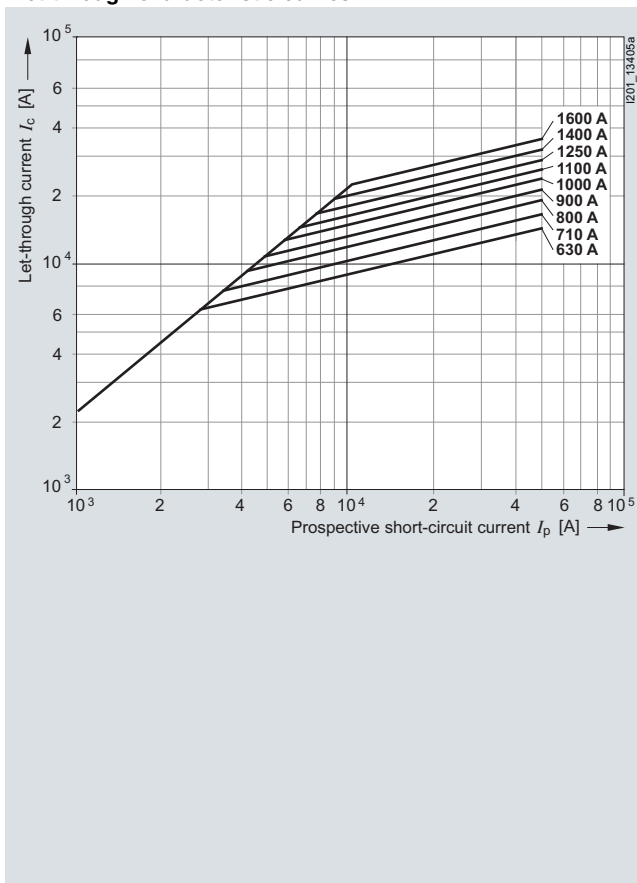

Correction factor k_A for breaking I^2t value

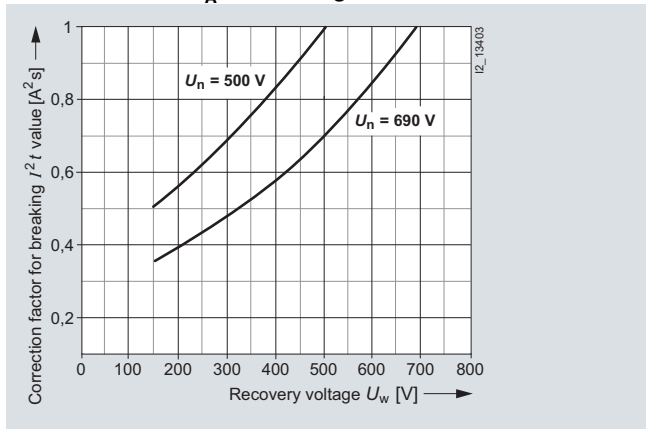

Peak arc voltage

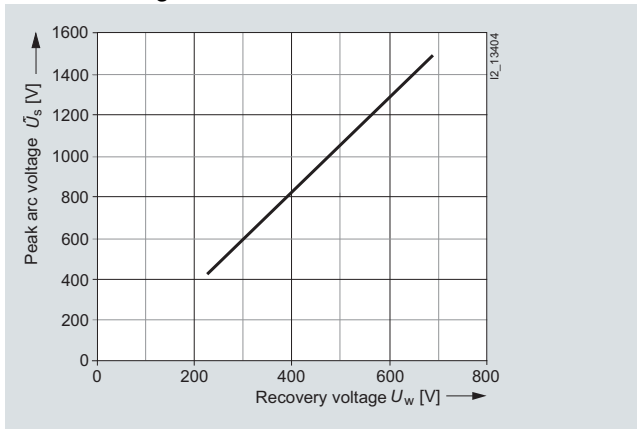

Fuse systems

SITOR semiconductor fuses

LV HRC design, 3NC, 3NE

3NC3 3 series

Size: 3
 Operational class: aR
 Rated voltage: 1000 V AC (630 ... 1000 A),
 800 V AC (1100 ... 1250 A)
 Rated current: 630 ... 1250 A

Time/current characteristics diagram

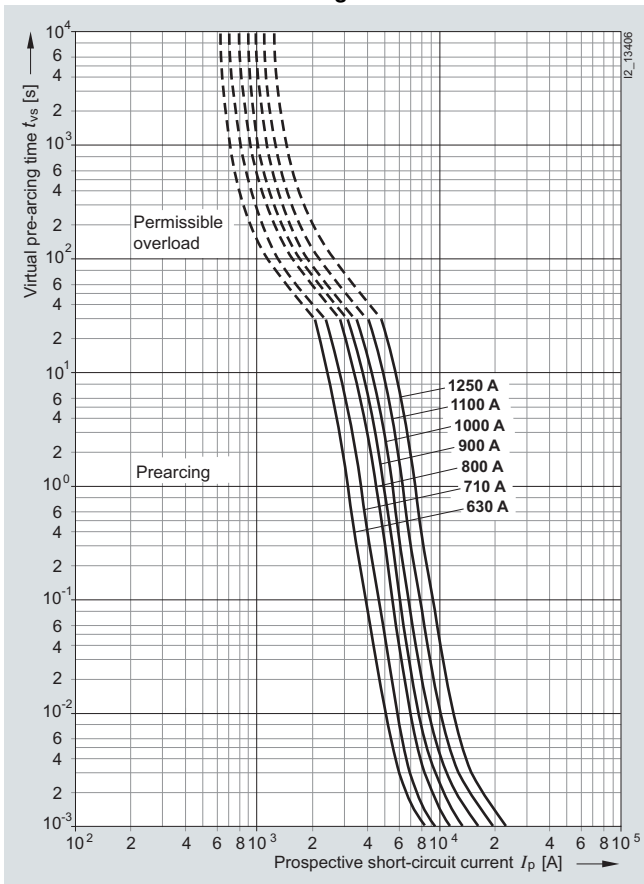

Let-through characteristic curves

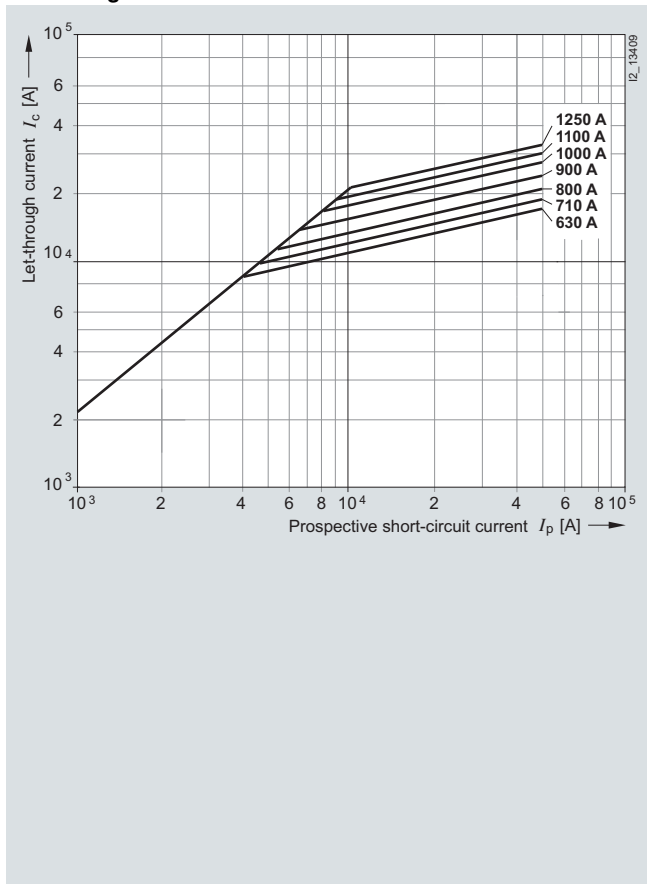

Correction factor k_A for breaking I^2t value

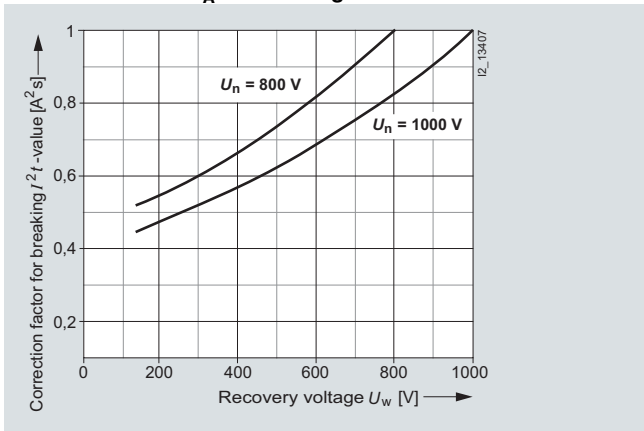

Peak arc voltage

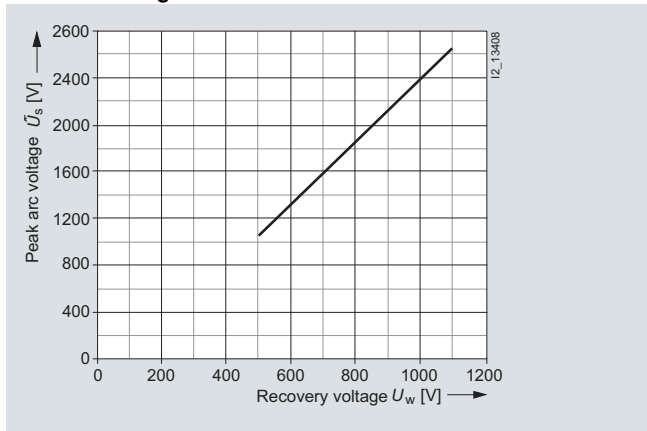

3NC3 4 series

Size: 3
 Operational class: aR
 Rated voltage: 1250 V AC (315 ... 630 A),
 1100 V AC (800 A)
 Rated current: 315 ... 800 A

Time/current characteristics diagram

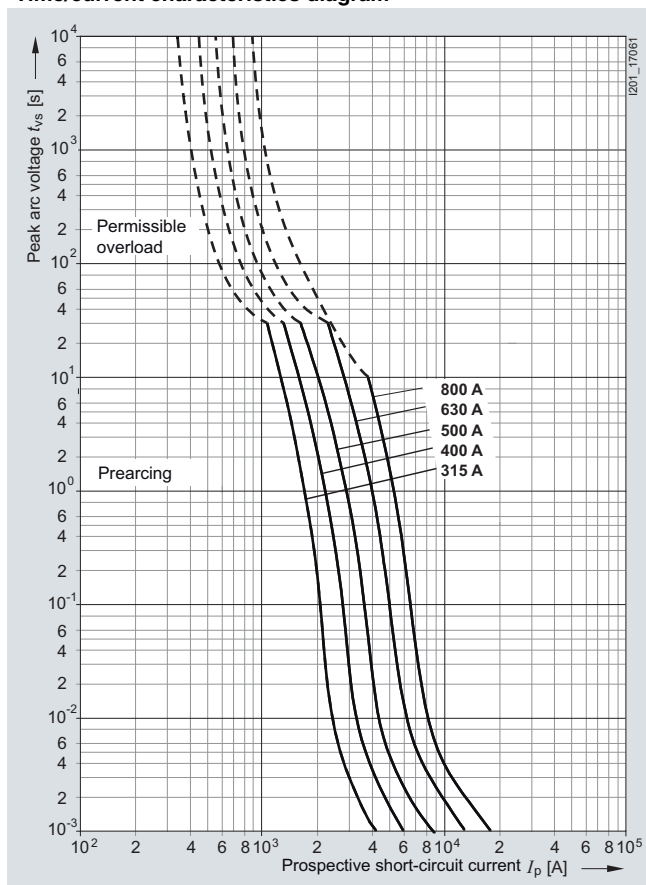

Let-through characteristic curves

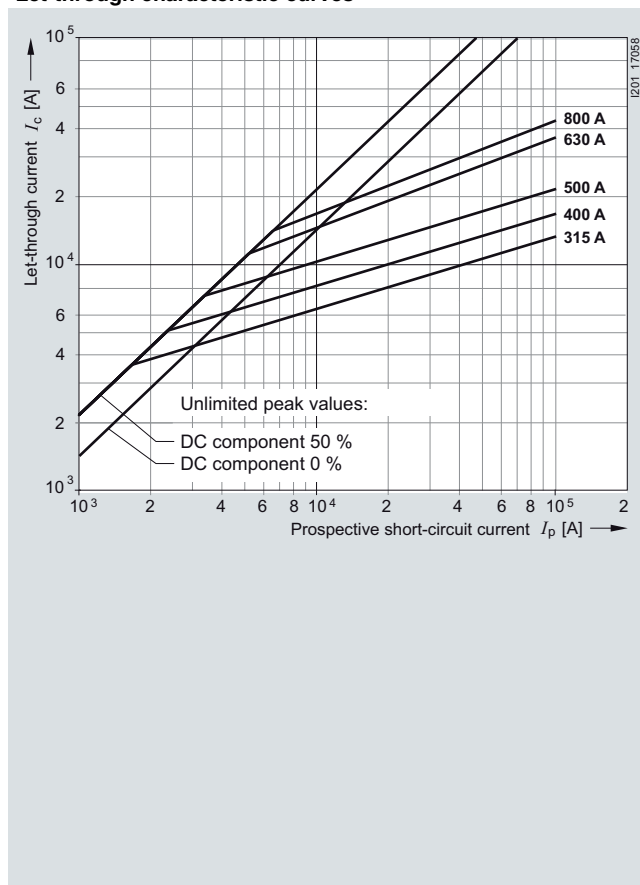

Correction factor k_A for breaking I^2t value

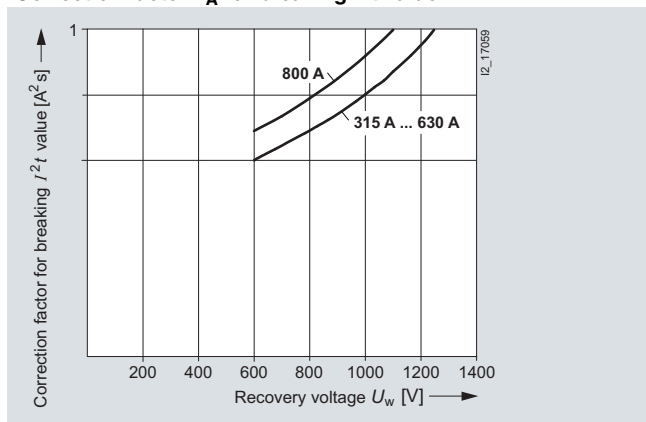

Peak arc voltage

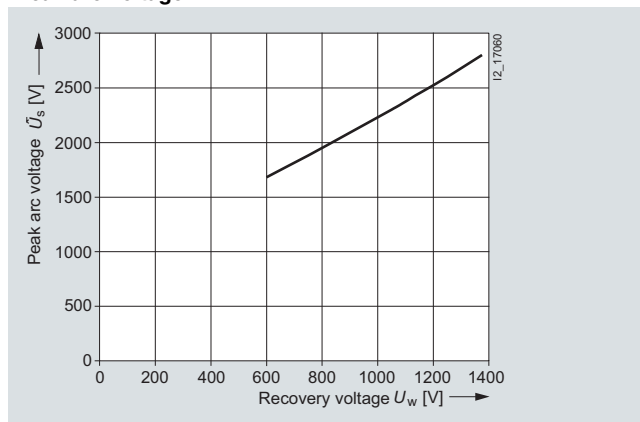

Fuse systems

SITOR semiconductor fuses

LV HRC design, 3NC, 3NE

Series 3NC5 531, 3NC5 8..

Operational class: aR
 Rated voltage: 800 V AC (350 A, 630 A),
 1000 V AC (600 A, 800 A)
 Rated current: 350 ... 800 A

Time/current characteristics diagram

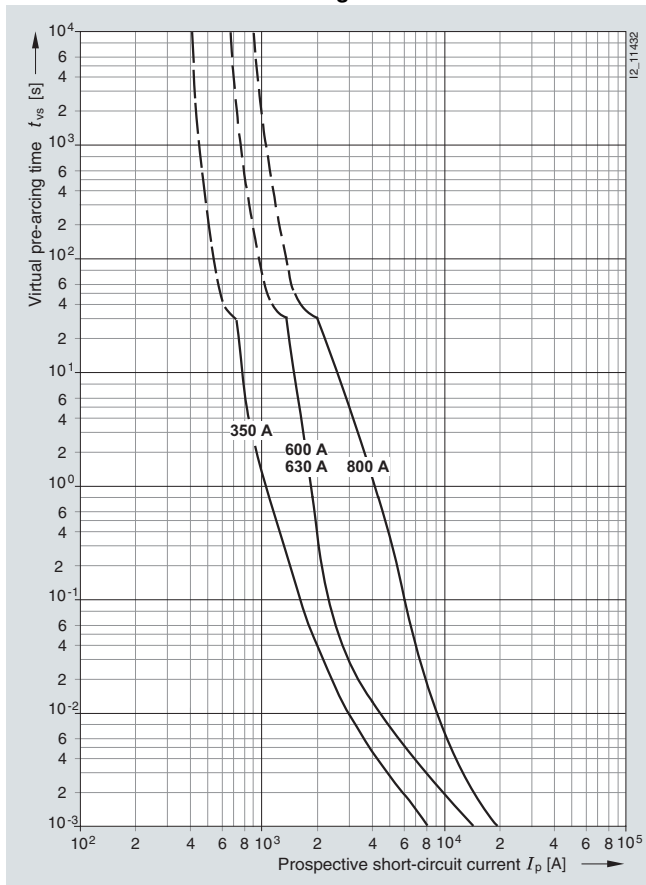

Let-through characteristics (current limitation at 50 Hz)

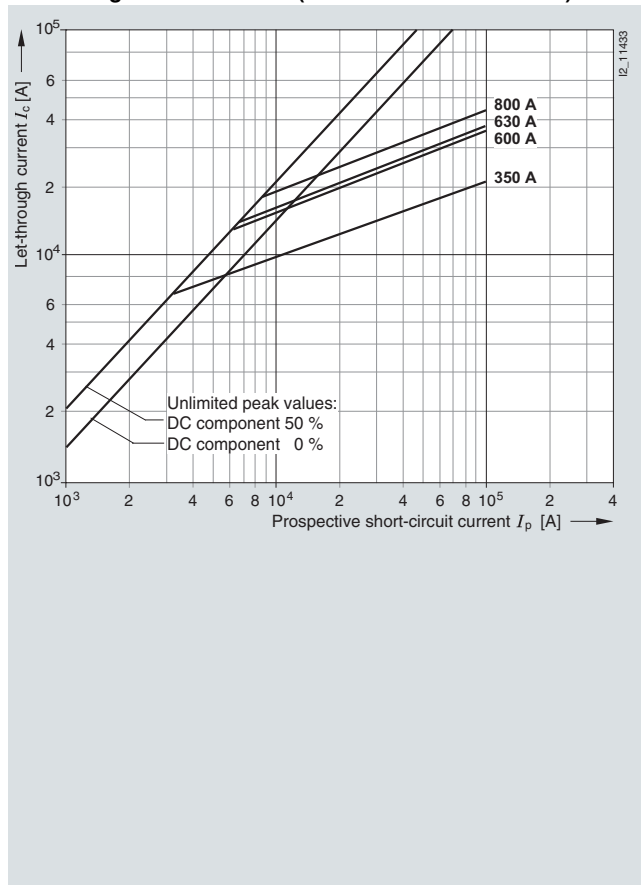

Correction factor k_A for breaking I^2t value

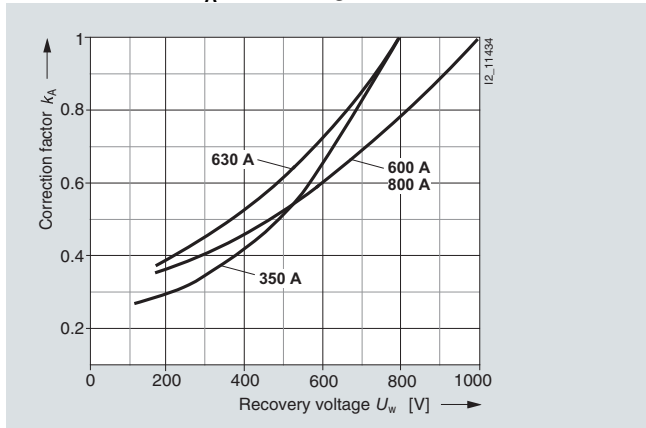

Peak arc voltage

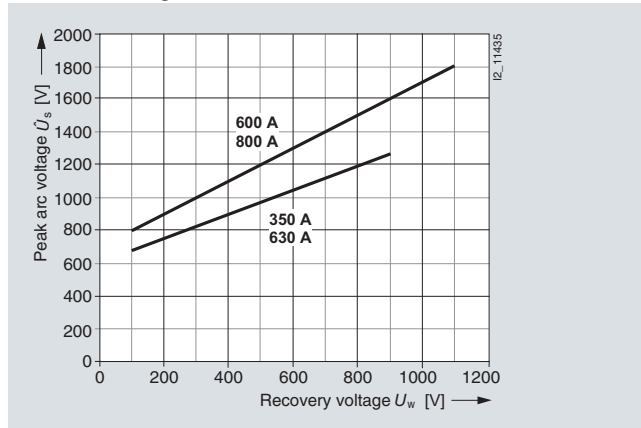

Series 3NC7 3...-2

Operational class: aR
 Rated voltage: 680 V AC
 Rated current: 250 A, 350 A

Time/current characteristics diagram

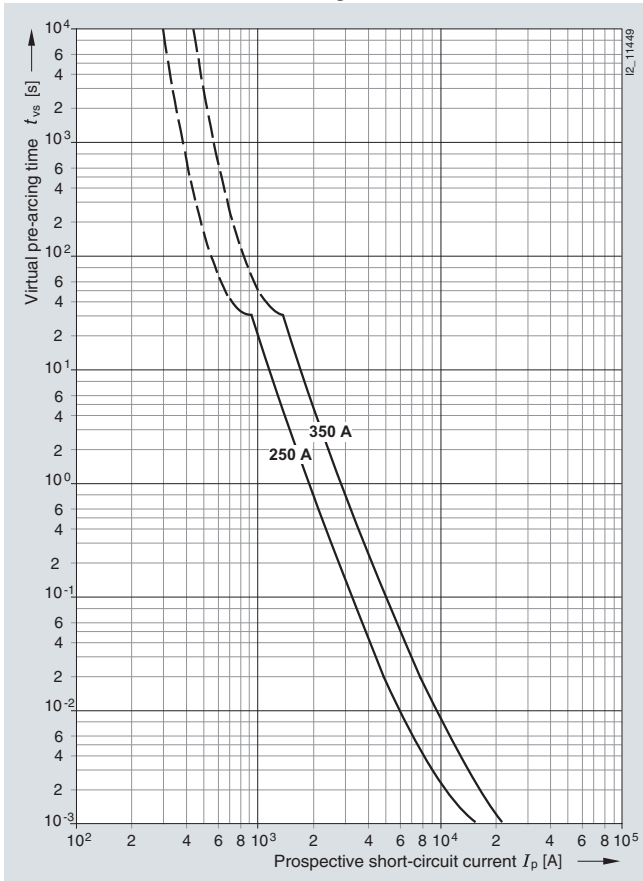

Let-through characteristics (current limitation at 50 Hz)

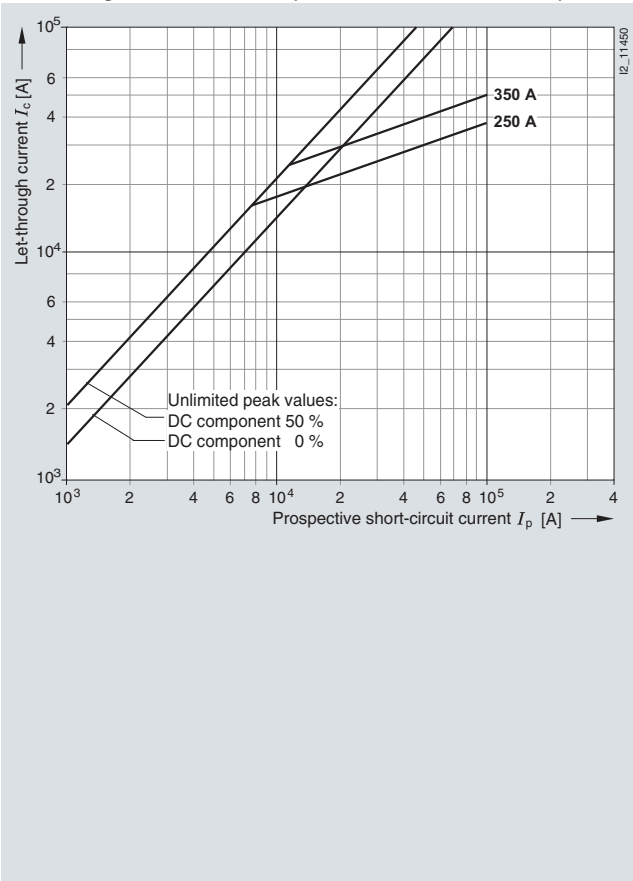

Correction factor k_A for breaking I^2t value

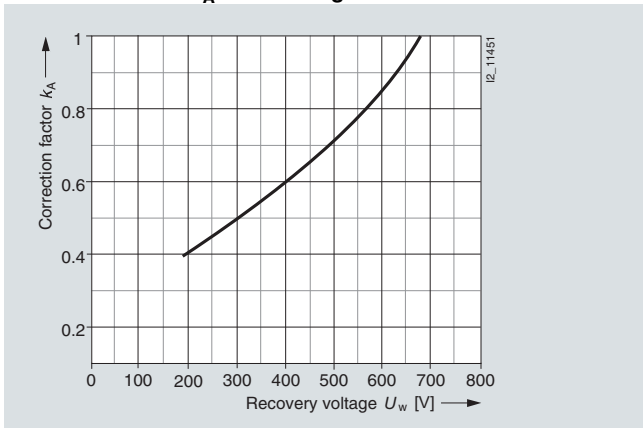

Peak arc voltage

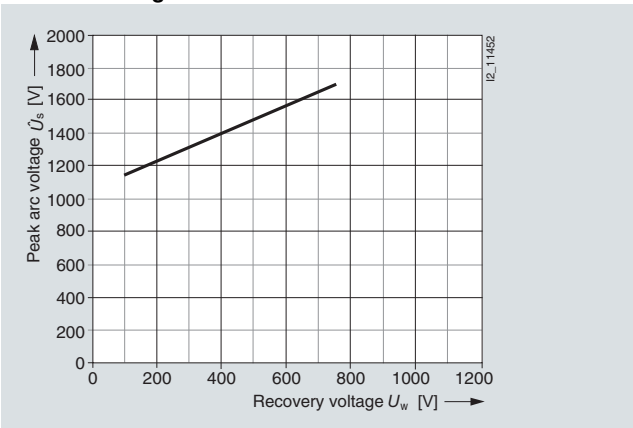

Fuse systems

SITOR semiconductor fuses

LV HRC design, 3NC, 3NE

Series 3NC8 4..

Size: 3
 Operational class: gR or aR
 Rated voltage: 660 V AC
 Rated current: 150 ... 1000 A

Time/current characteristics diagram

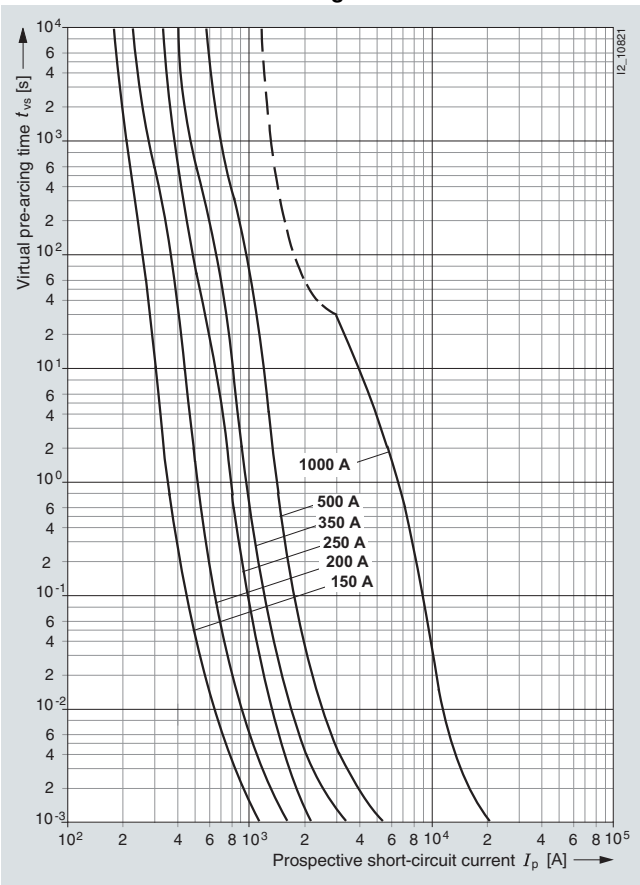

Let-through characteristics (current limitation at 50 Hz)

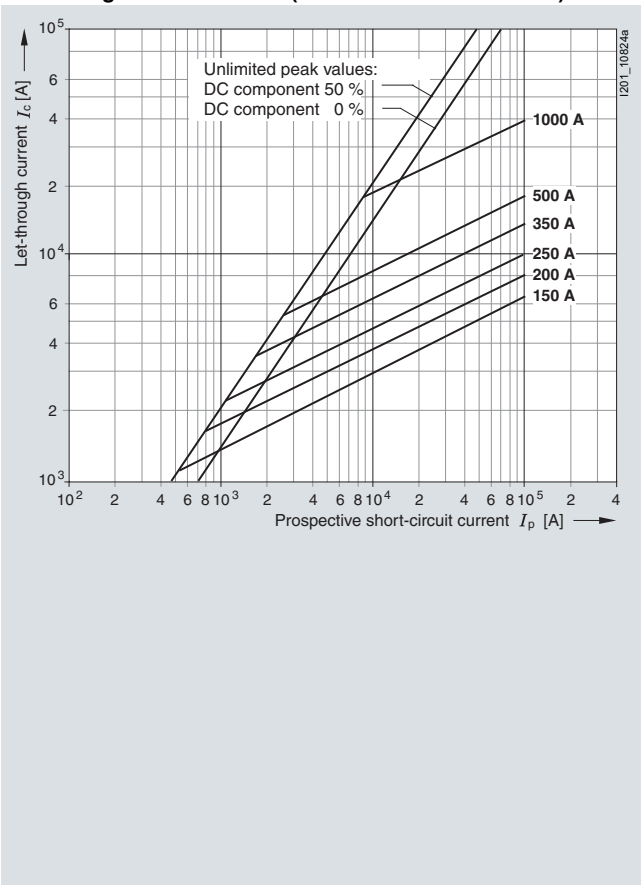

Correction factor k_A for breaking I^2t value

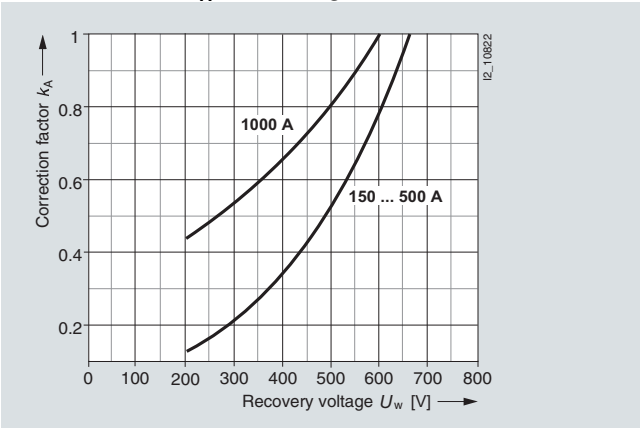

Peak arc voltage

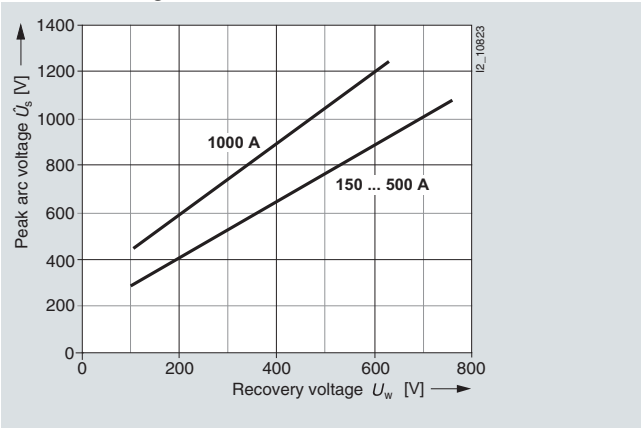

Series 3NE1 02.-0, 3NE1 2..-0

Size: 00, 1
 Operational class: gS
 Rated voltage: 690 V AC
 Rated current: 100 ... 315 A

Time/current characteristics diagram

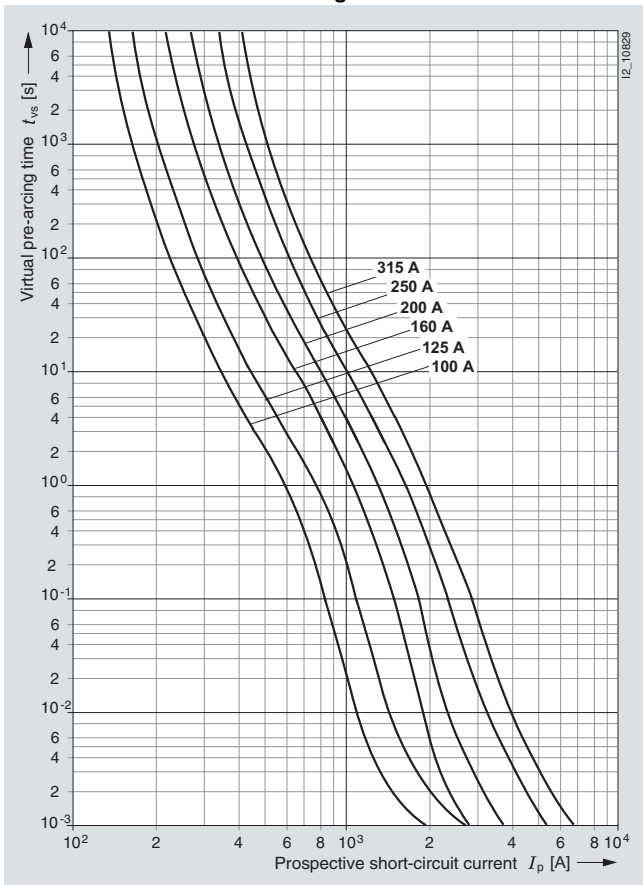

Let-through characteristics (current limitation at 50 Hz)

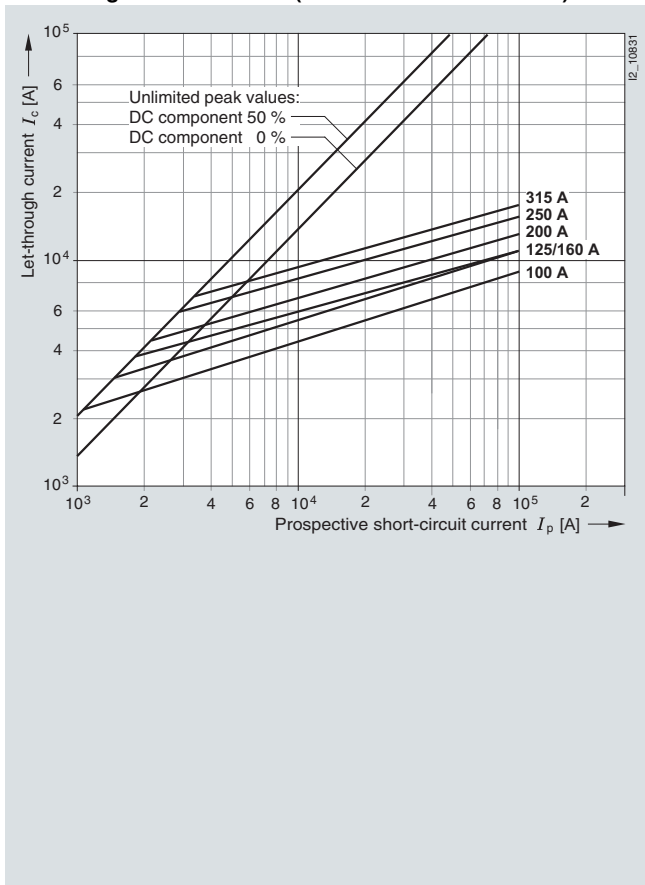

Correction factor k_A for breaking I^2t value

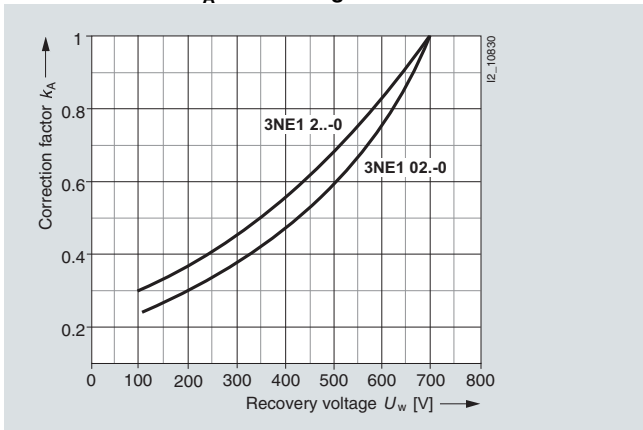

Peak arc voltage

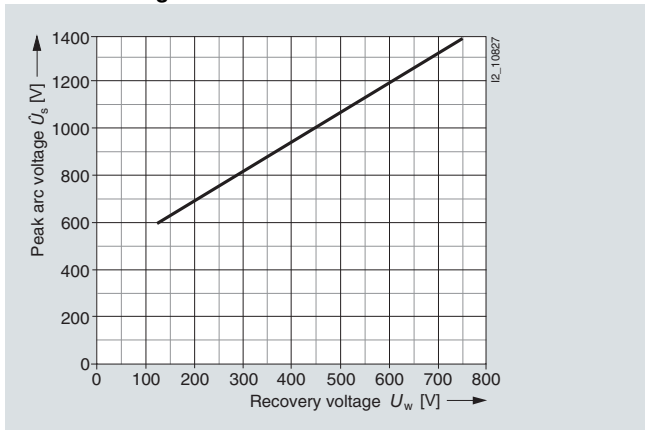

Fuse systems

SITOR semiconductor fuses

LV HRC design, 3NC, 3NE

Series 3NE1 02..-2, 3NE1 2..-2, 3NE1 2..-3, 3NE1 3..-2, 3NE1 3..-3

Sizes: 00, 1, 2
 Operational class: gR
 Rated voltage: 690 V AC
 Rated current: 80 ... 500 A

Time/current characteristics diagram

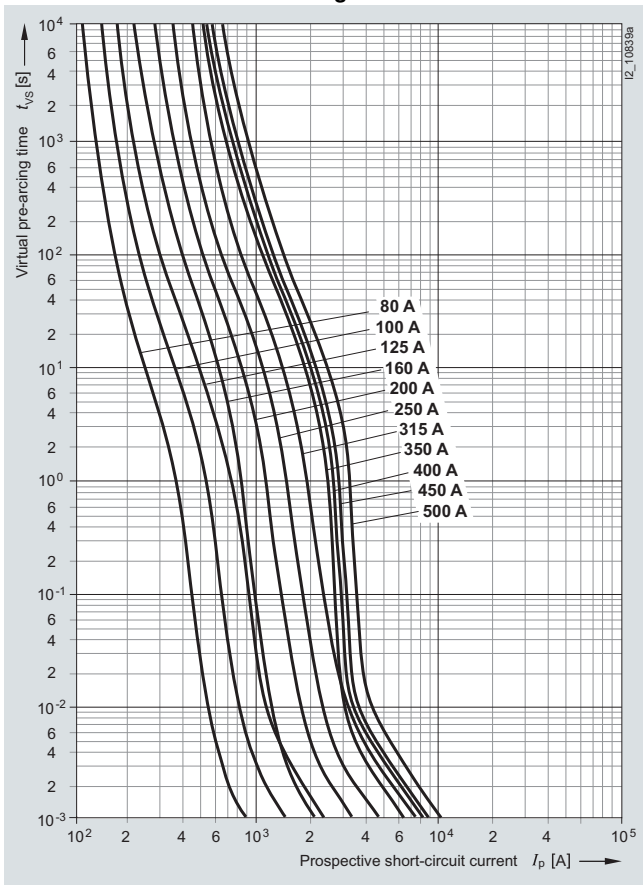

Let-through characteristics (current limitation at 50 Hz)

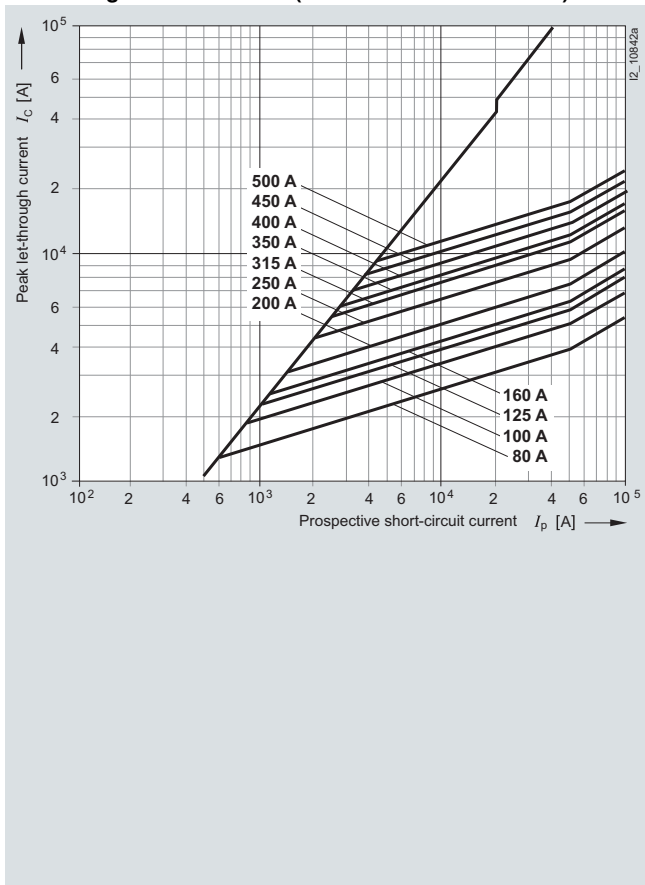

Correction factor k_A for breaking I^2t value

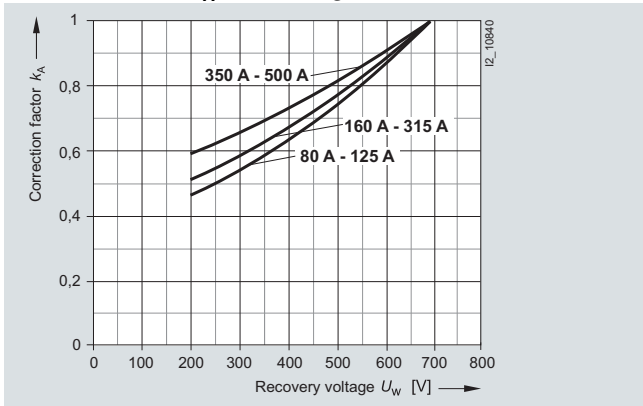

Peak arc voltage

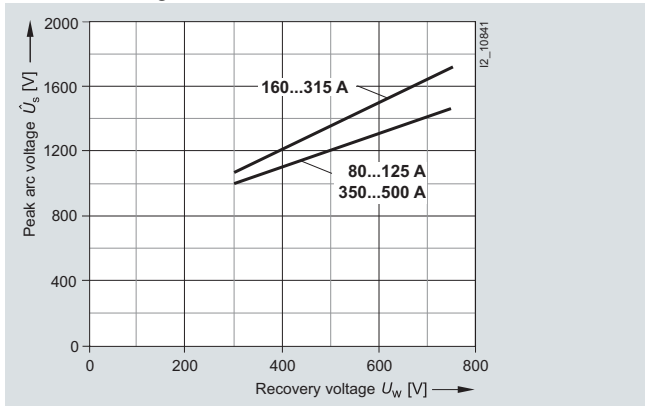

Series 3NE1 33.-0, 3NE1 43.-0

Size: 2, 3
 Operational class: gS
 Rated voltage: 690 V AC
 Rated current: 350 ... 800 A

Time/current characteristics diagram

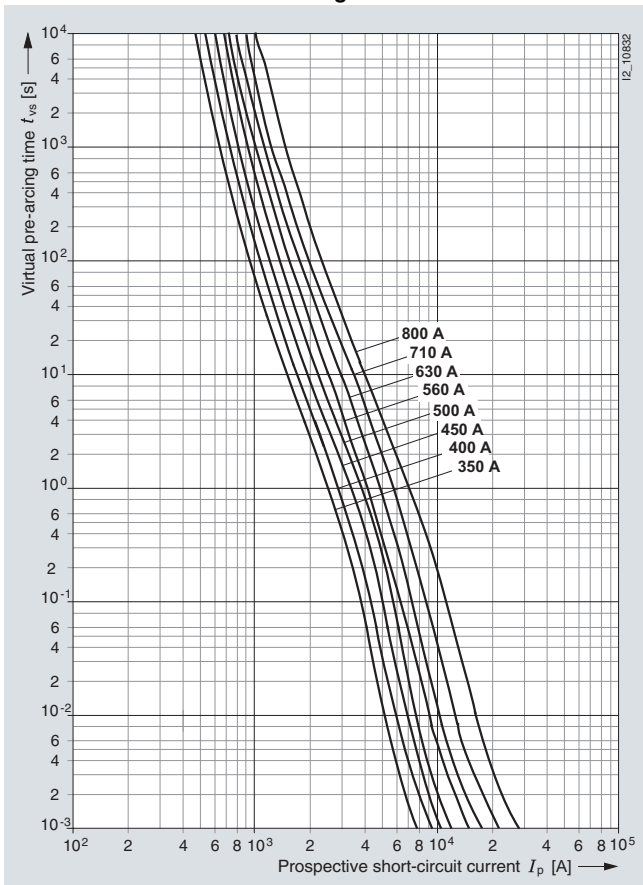

Let-through characteristics (current limitation at 50 Hz)

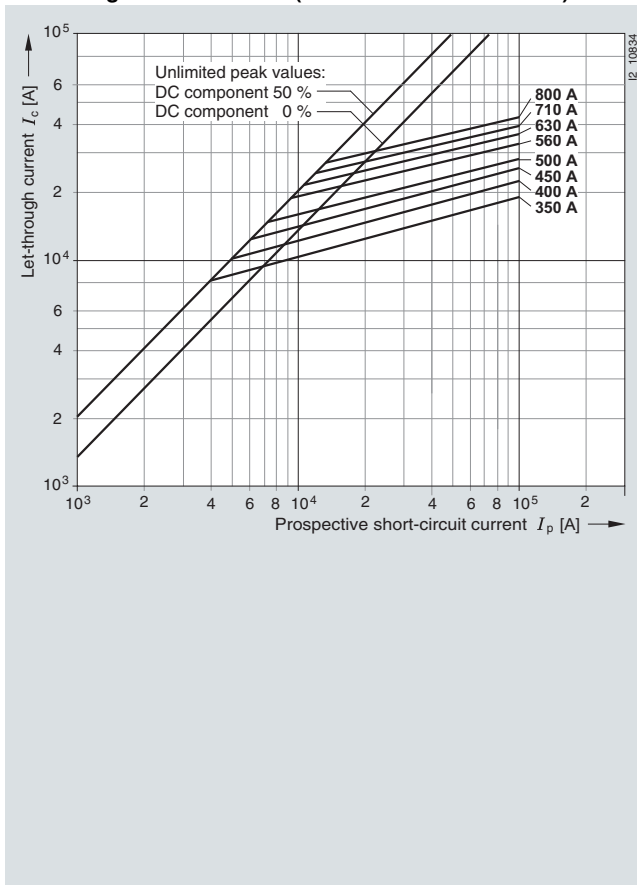

Correction factor k_A for breaking I^2t value

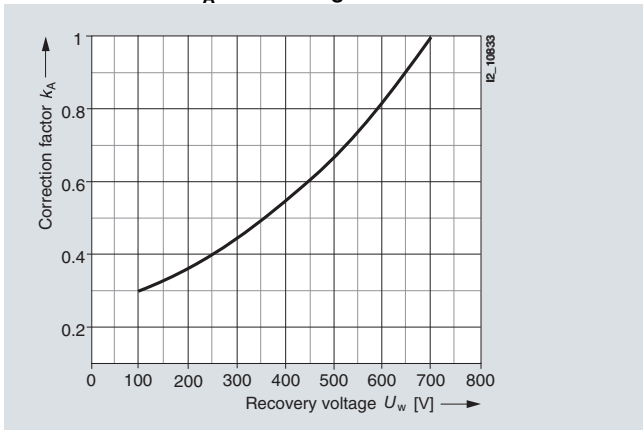

Peak arc voltage

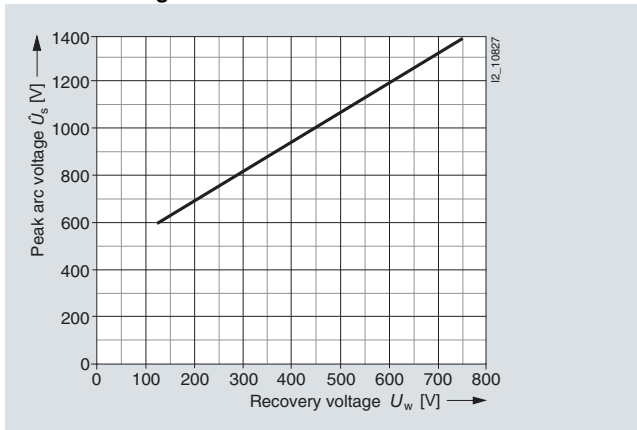

Fuse systems

SITOR semiconductor fuses

LV HRC design, 3NC, 3NE

Series 3NE1 4...-2, 3NE1 4...-3

Size: 3
 Operational class: gR
 Rated voltage: 690 V AC
 Rated current: 560 ... 850 A

Time/current characteristics diagram

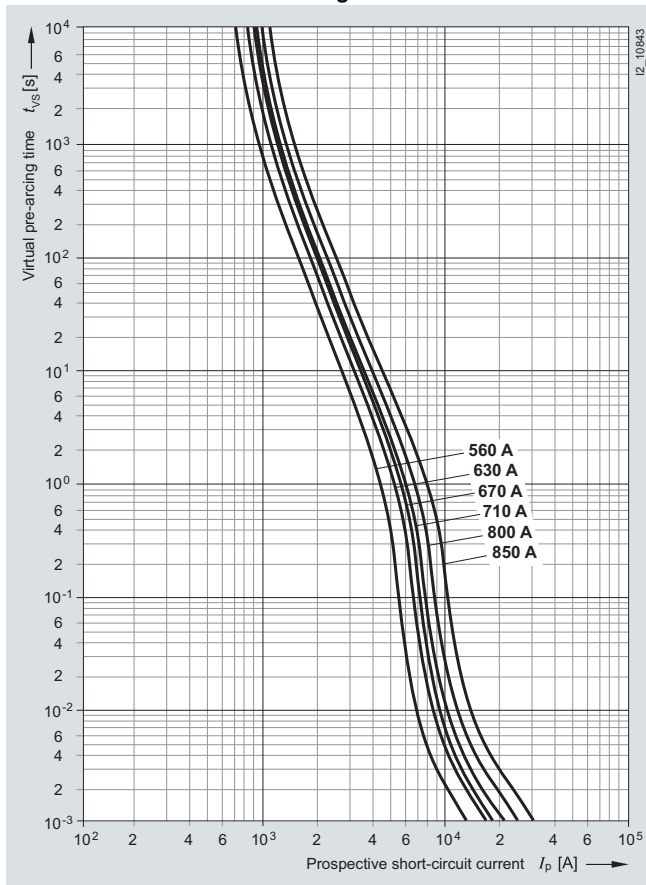

Let-through characteristics (current limitation at 50 Hz)

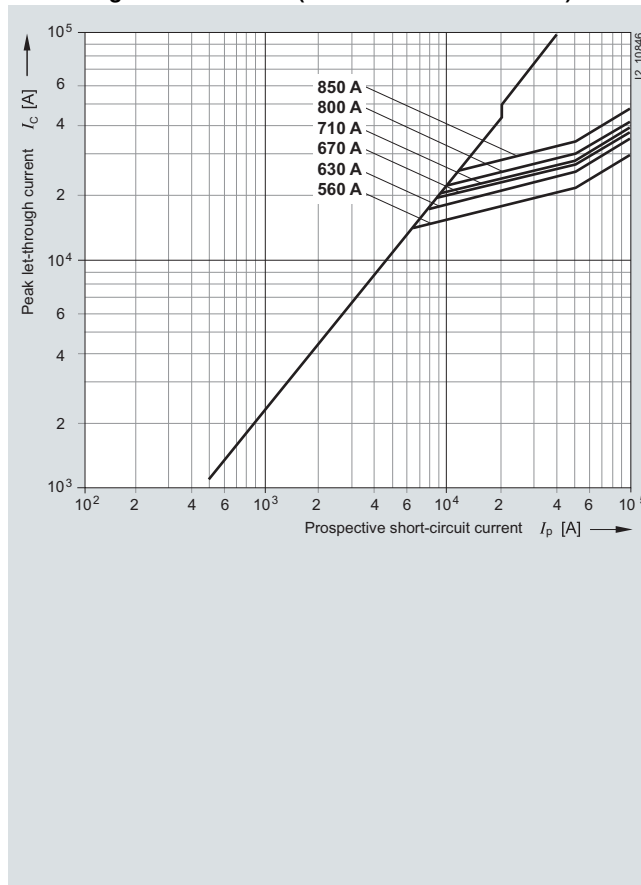

Correction factor k_A for breaking I^2t value

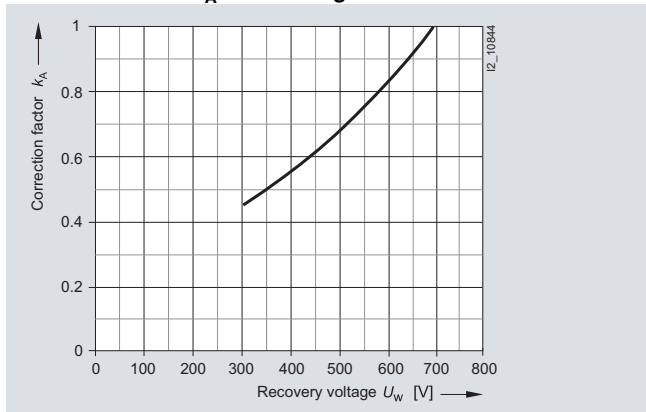

Peak arc voltage

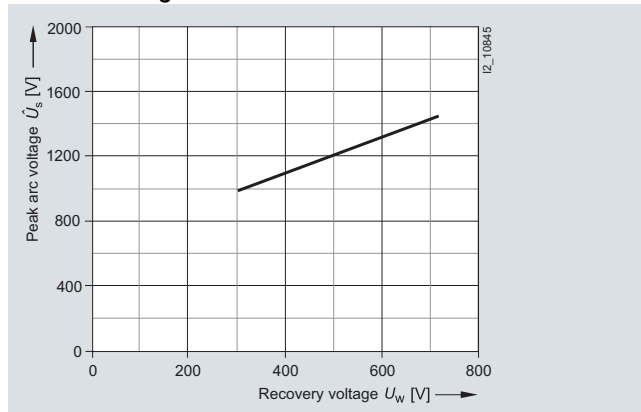

Series 3NE1 437-1, 3NE1 438-1

Size: 3
 Operational class: gR
 Rated voltage: 600 V AC
 Rated current: 710 and 800 A

Time/current characteristics diagram

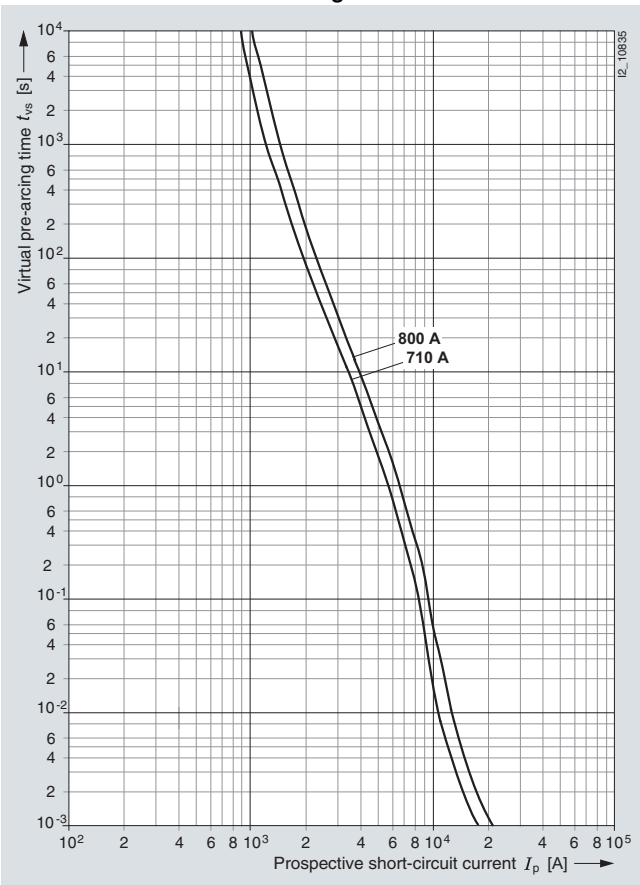

Let-through characteristics (current limitation at 50 Hz)

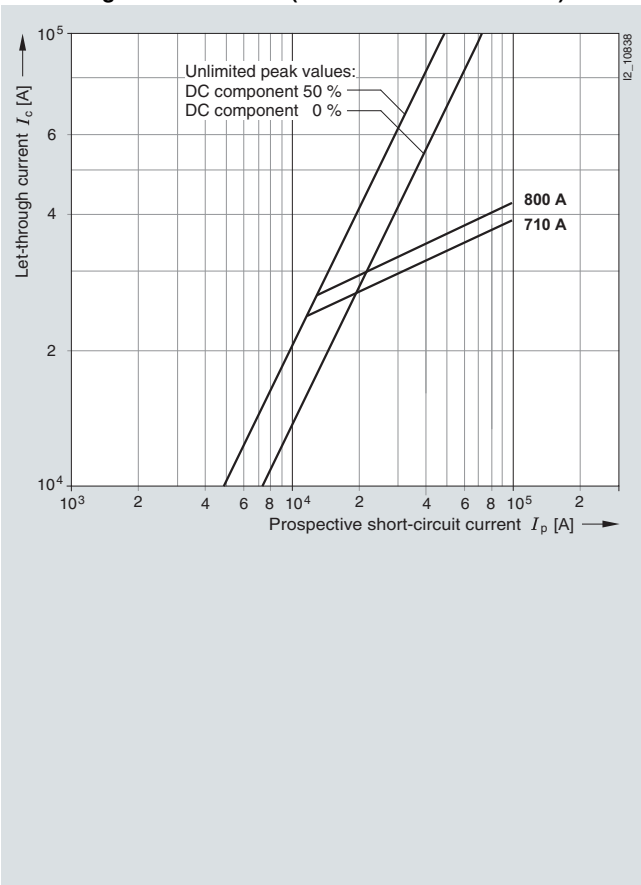

Correction factor k_A for breaking I^2t value

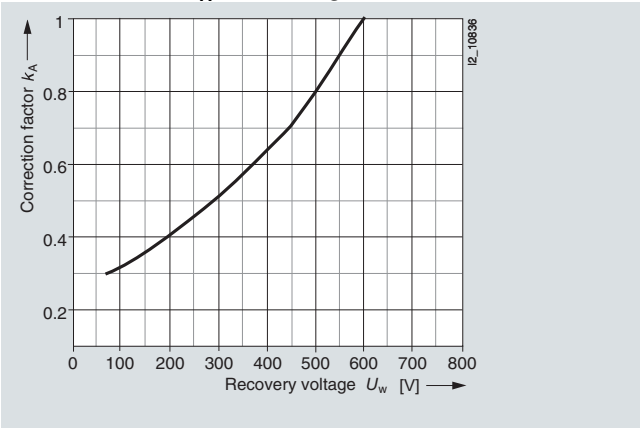

Peak arc voltage

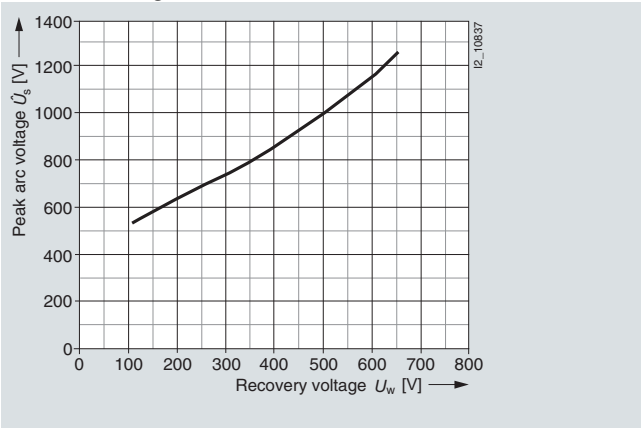

Fuse systems

SITOR semiconductor fuses

LV HRC design, 3NC, 3NE

Series 3NE1 8...0

Size: 000
 Operational class: gS
 Rated voltage: 690 V AC
 Rated current: 16 ... 80 A

Time/current characteristics diagram

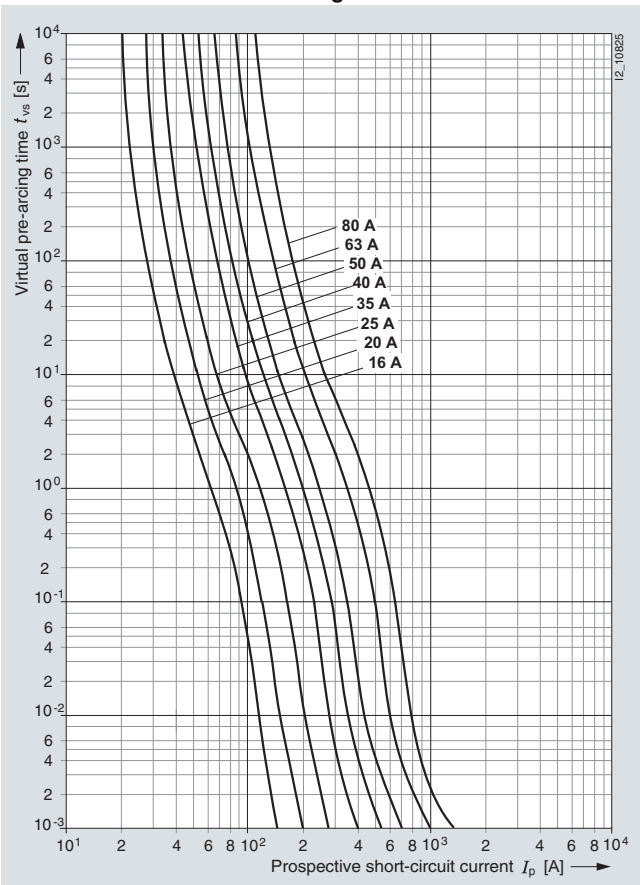

Let-through characteristics (current limitation at 50 Hz)

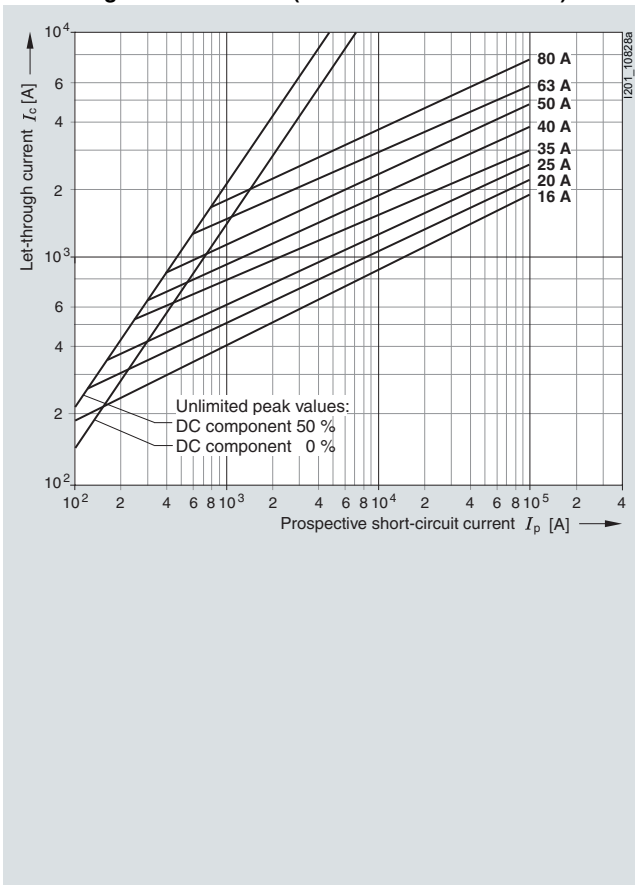

Correction factor k_A for breaking I^2t value

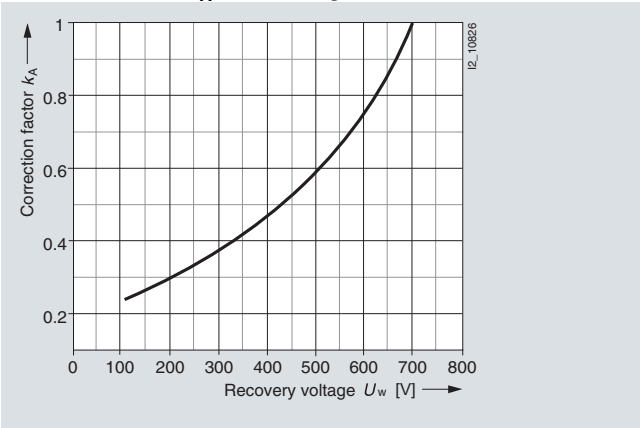

Peak arc voltage

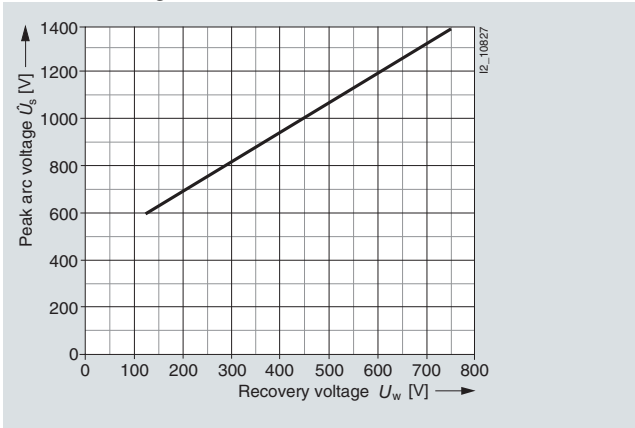

Series 3NE3 22.

Size: 1
 Operational class: aR
 Rated voltage: 1000 V AC
 Rated current: 100 ... 250 A

Time/current characteristics diagram

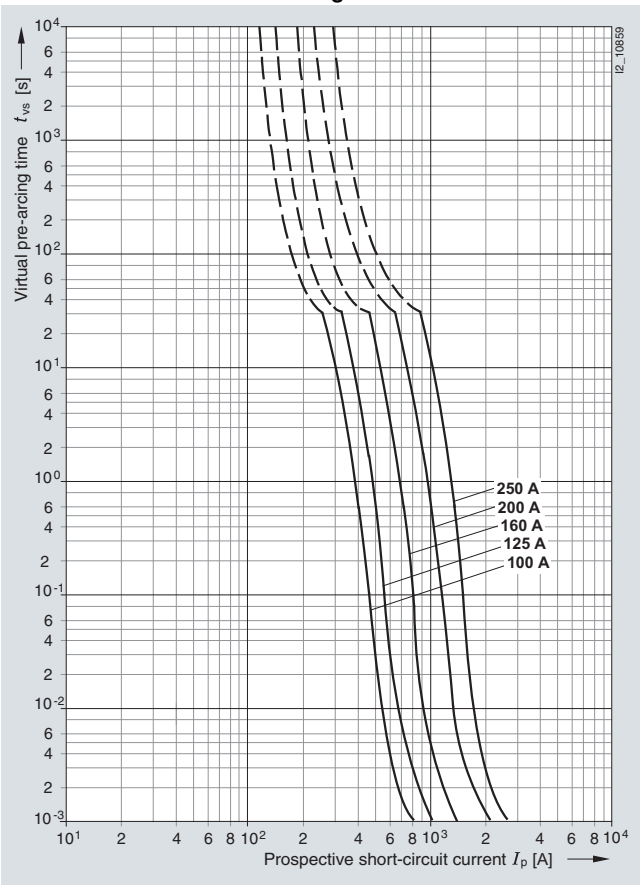

Let-through characteristics (current limitation at 50 Hz)

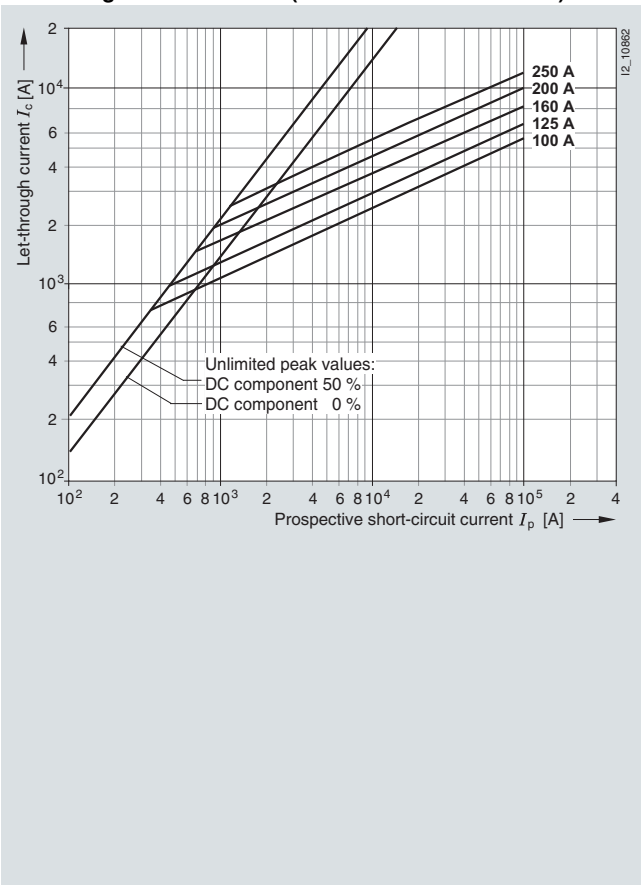

Correction factor k_A for breaking I^2t value

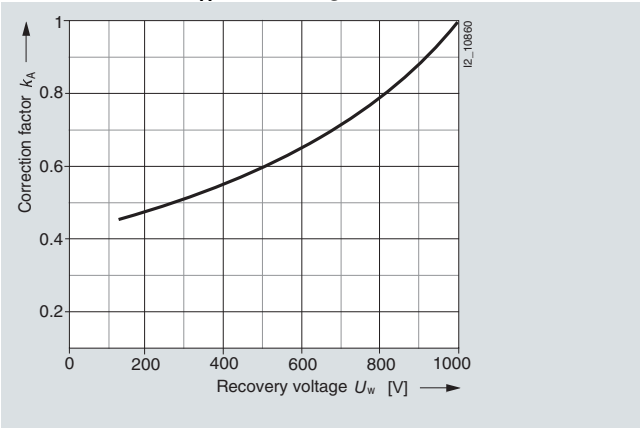

Peak arc voltage

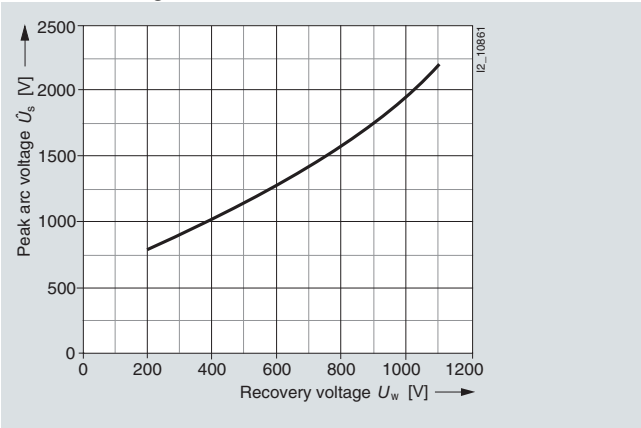

Fuse systems

SITOR semiconductor fuses

LV HRC design, 3NC, 3NE

Series 3NE3 23.

Size: 1
 Operational class: aR
 Rated voltage: 1000 V AC
 Rated current: 315 ... 450 A

Time/current characteristics diagram

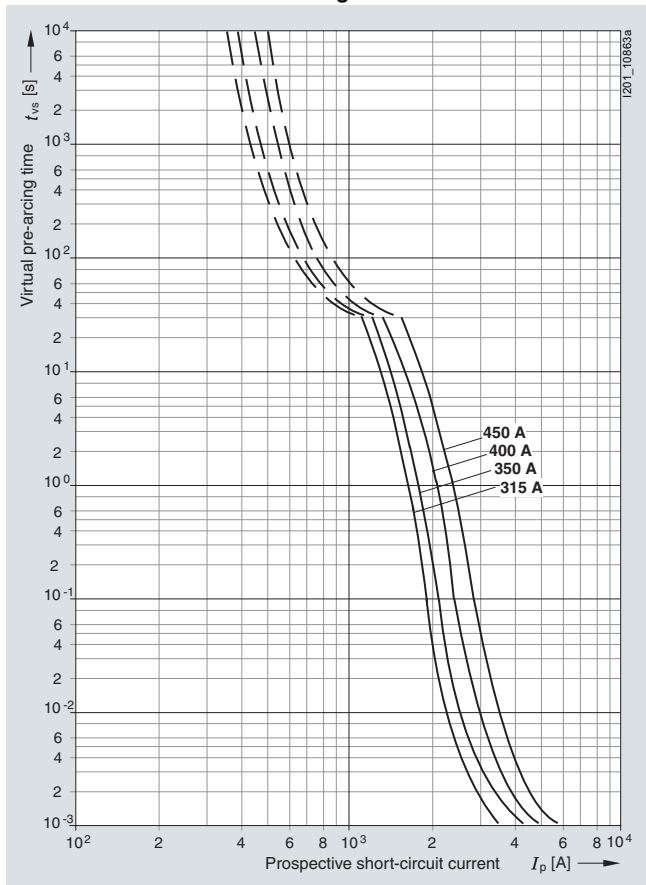

Let-through characteristics (current limitation at 50 Hz)

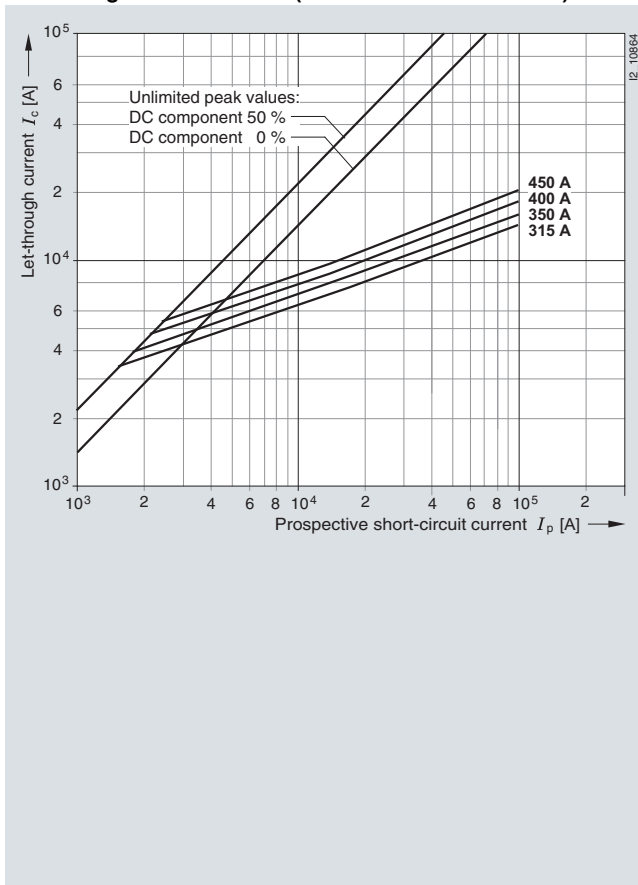

Correction factor k_A for breaking I^2t value

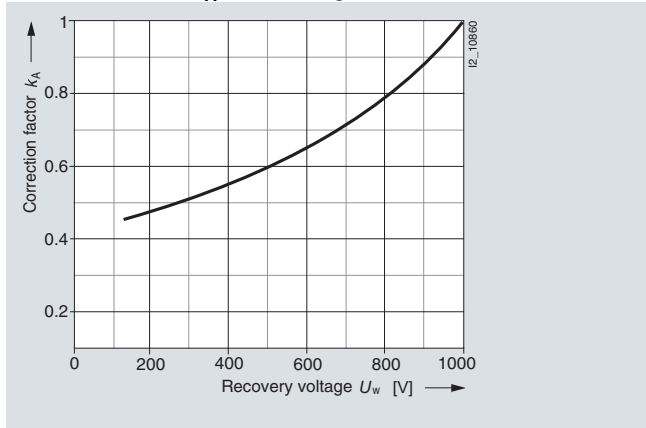

Peak arc voltage

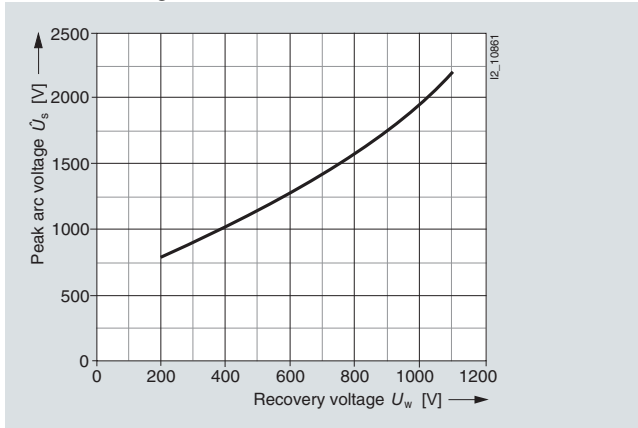

Series 3NE3 3..

Size: 2
 Operational class: aR
 Rated voltage: 1000 V AC (up to 630 A)
 900 V AC (710 A)
 800 V AC (800 A)
 690 V AC (900 A)
 Rated current: 400 ... 900 A

Time/current characteristics diagram

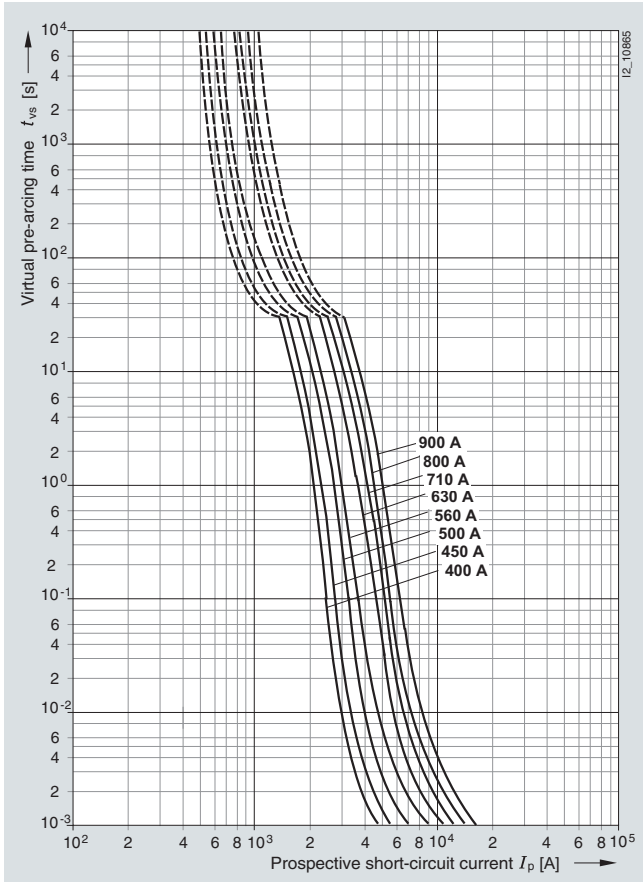

Let-through characteristics (current limitation at 50 Hz)

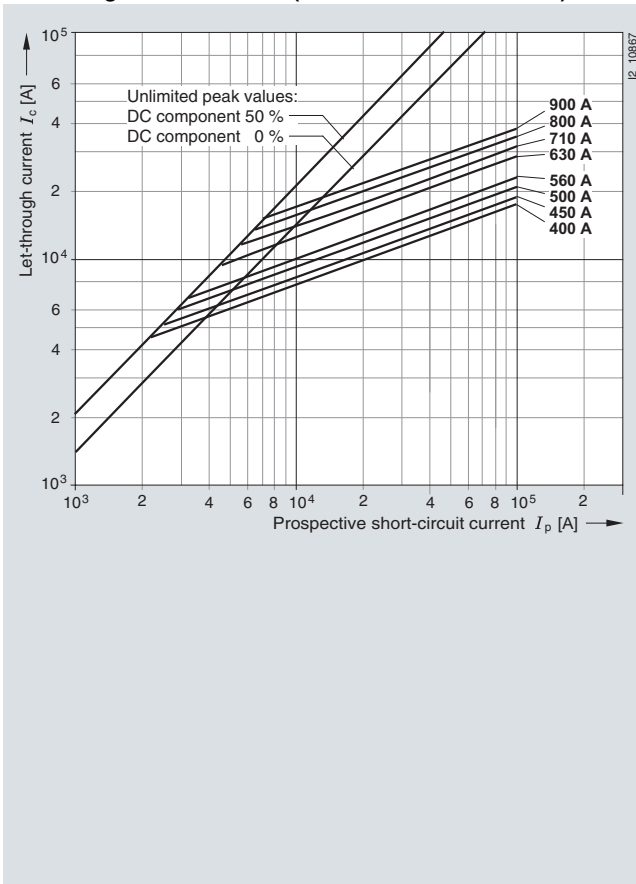

Correction factor k_A for breaking I^2t value

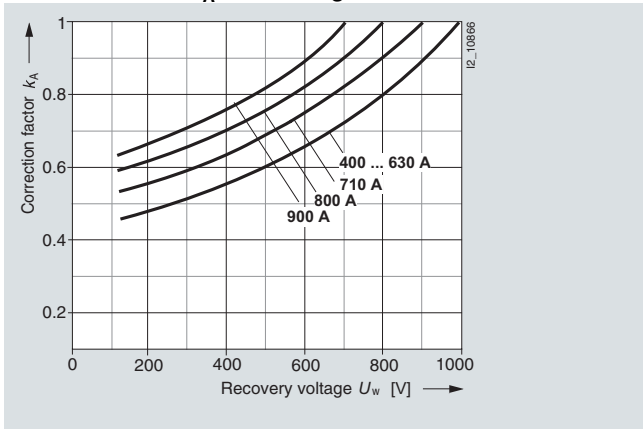

Peak arc voltage

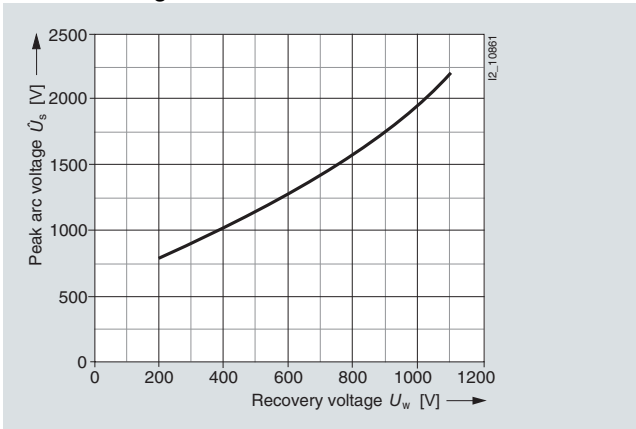

Fuse systems

SITOR semiconductor fuses

LV HRC design, 3NC, 3NE

Series 3NE3 4.., 3NE3 6..

Size: 3
 Operational class: aR
 Rated voltage: 1000 V AC
 Rated current: 100 ... 710 A

Time/current characteristics diagram

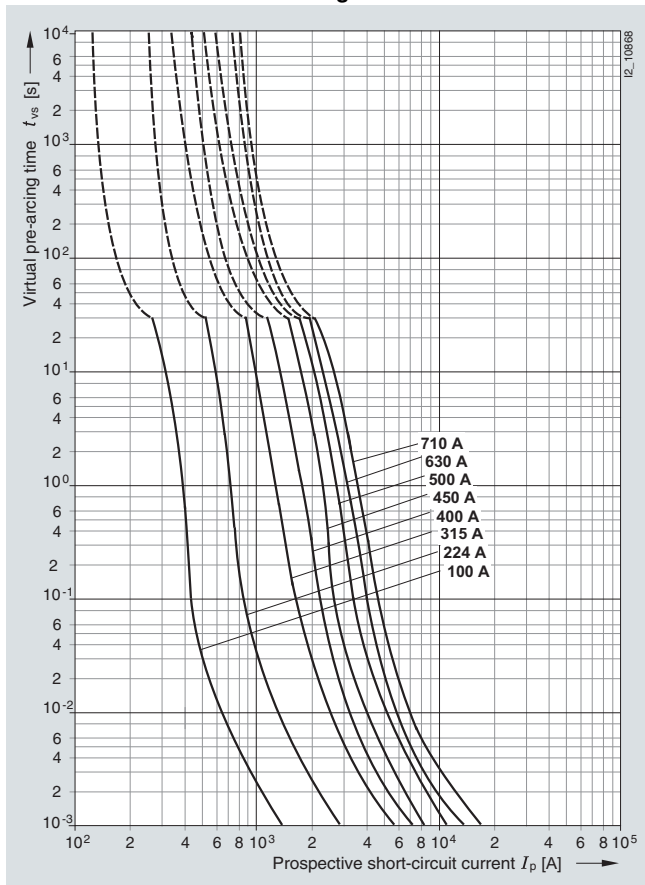

Let-through characteristics (current limitation at 50 Hz)

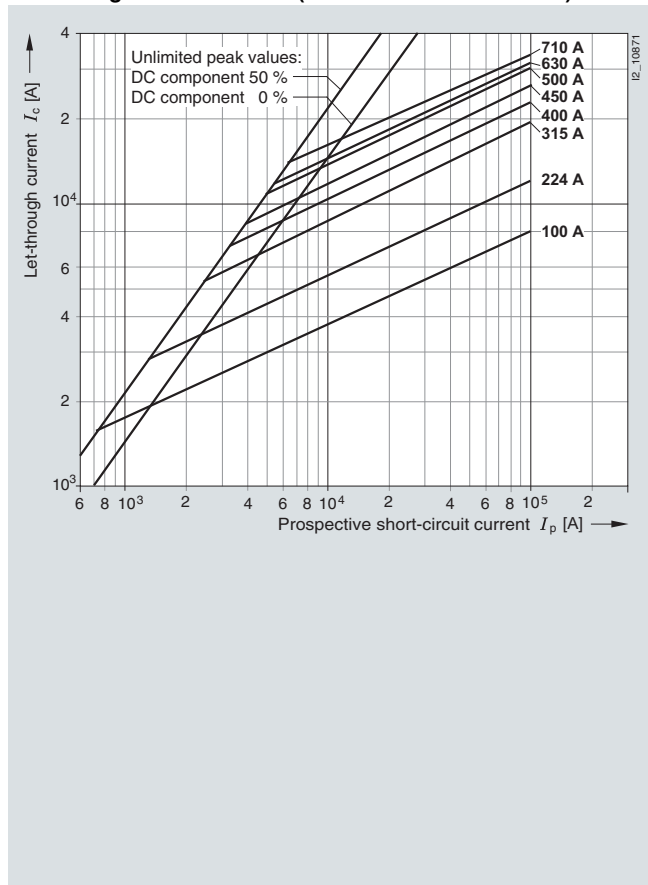

Correction factor k_A for breaking I^2t value

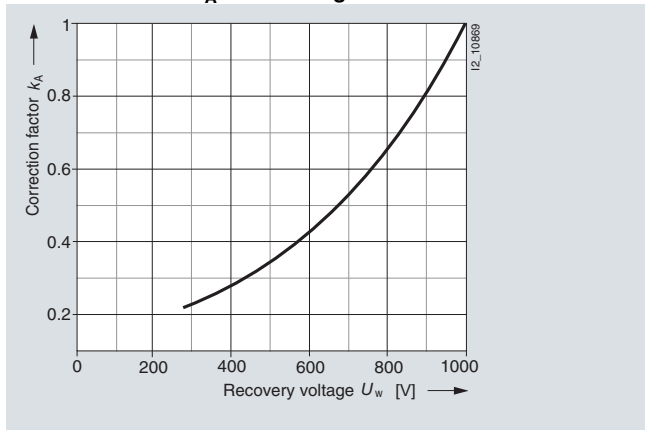

Peak arc voltage

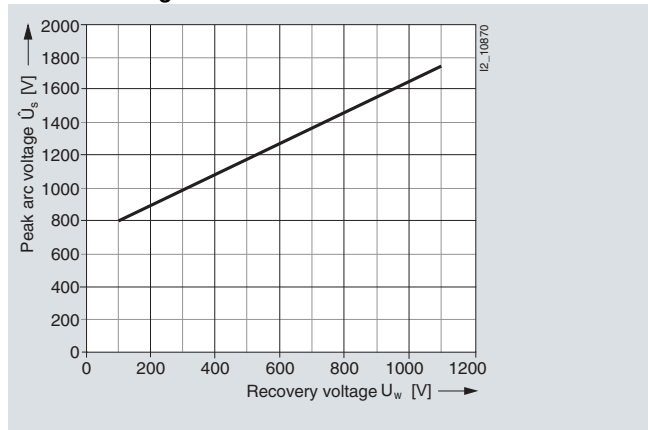

Fuse systems

SITOR semiconductor fuses

LV HRC design, 3NC, 3NE

Series 3NE3 5.5-5, 3NE4 1..-5

Operational class: aR, gR
 Rated voltage: 800 V AC (170 A)
 1000 V AC (50 A, 100 A, 200 A, 450 A)
 Rated current: 50 ... 450 A

Time/current characteristics diagram

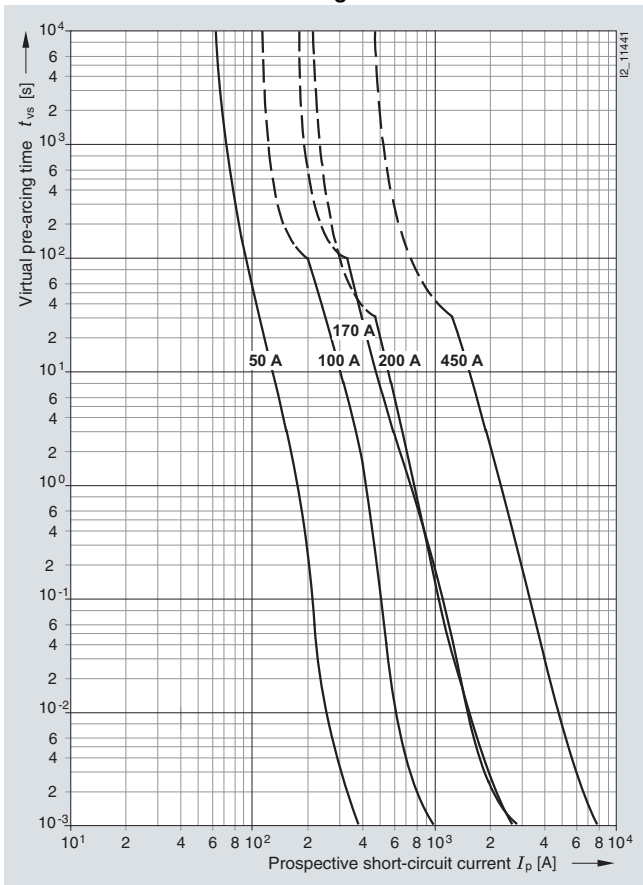

Let-through characteristics (current limitation at 50 Hz)

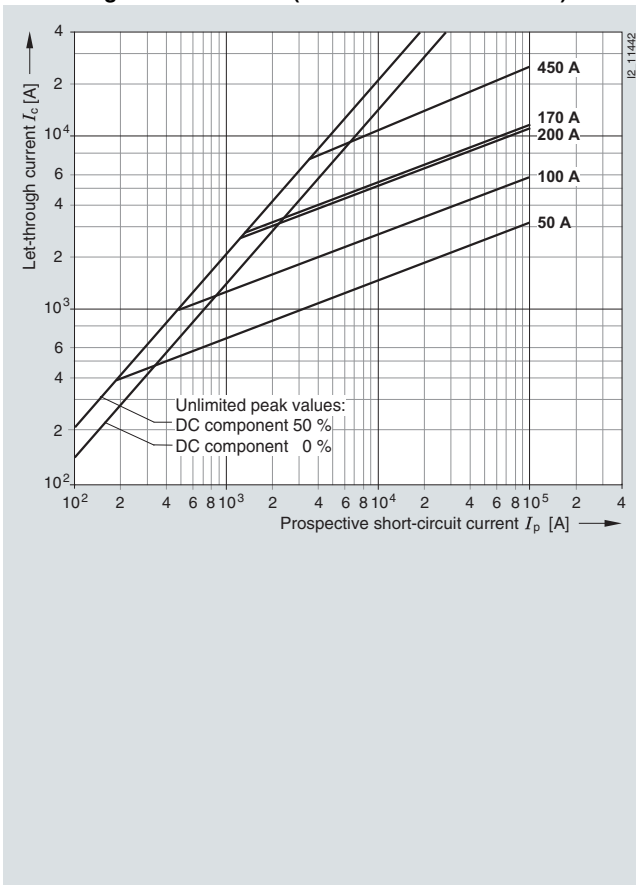

Correction factor k_A for breaking I^2t value

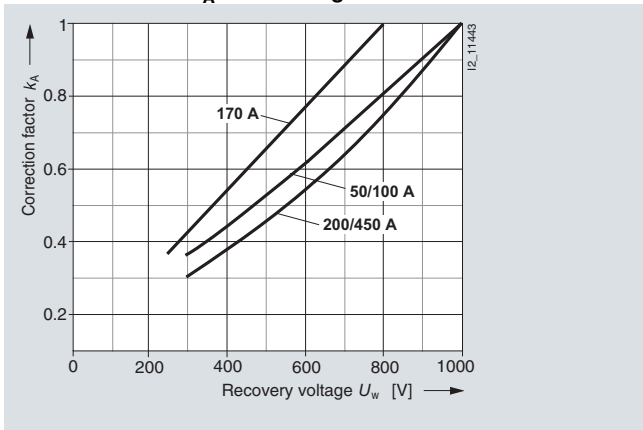

Peak arc voltage

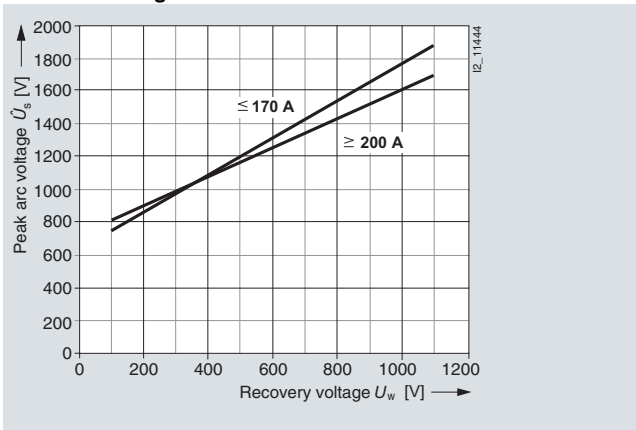

Fuse systems

SITOR semiconductor fuses

LV HRC design, 3NC, 3NE

Series 3NE4 1..

Size: 0
 Operational class: gR or aR
 Rated voltage: 1000 V AC
 Rated current: 32 ... 160 A

Time/current characteristics diagram

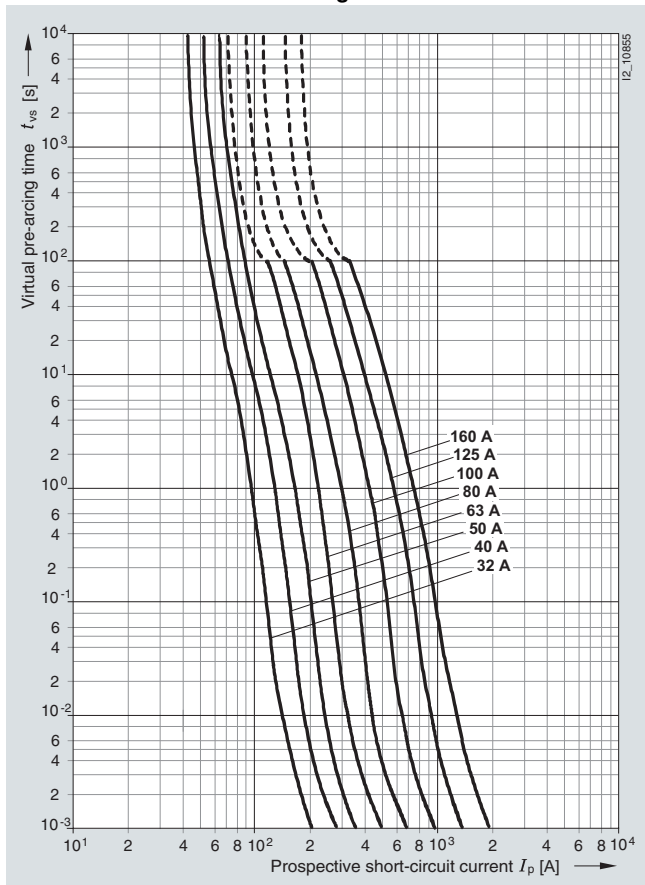

Let-through characteristics (current limitation at 50 Hz)

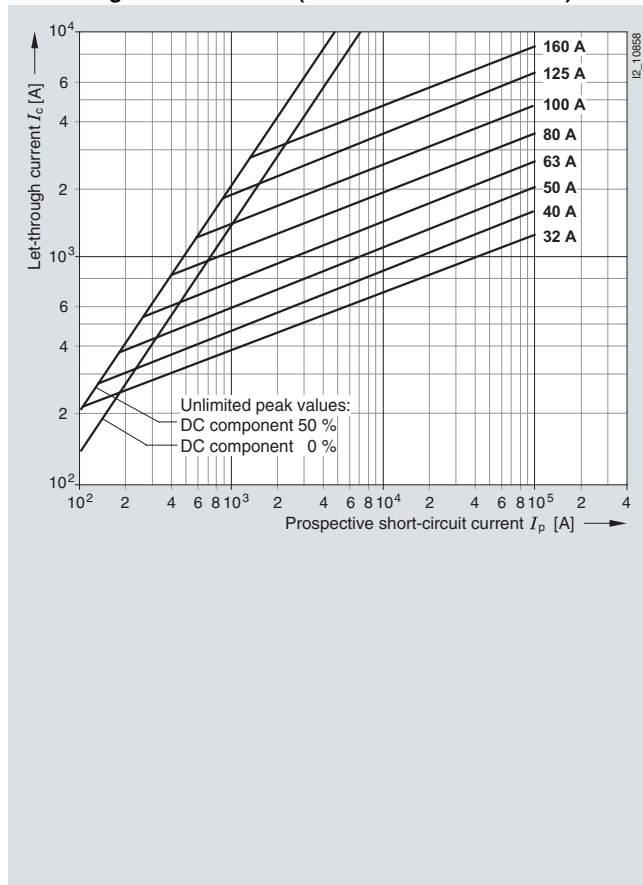

Correction factor k_A for breaking I^2t value

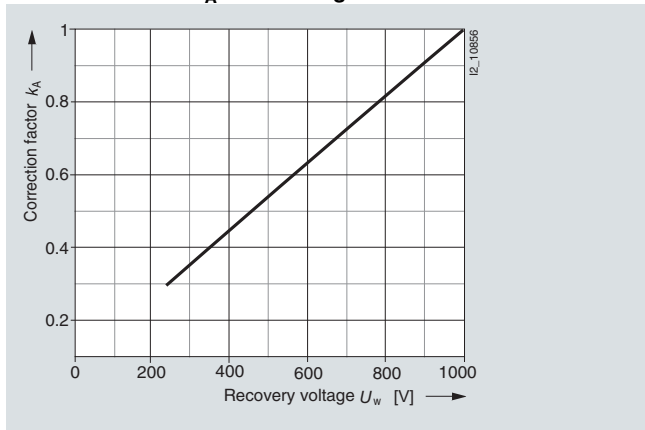

Peak arc voltage

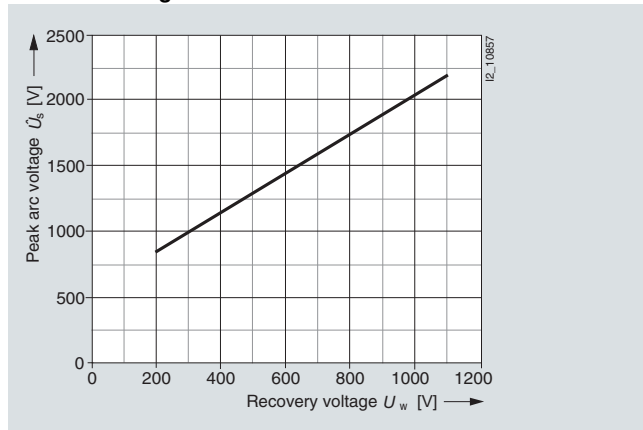

Fuse systems

SITOR semiconductor fuses

LV HRC design, 3NC, 3NE

Series 3NE4 3...-0B, 3NE4 337

Size: 2
 Operational class: aR
 Rated voltage: 800 V AC
 Rated current: 250 ... 710 A

Time/current characteristics diagram

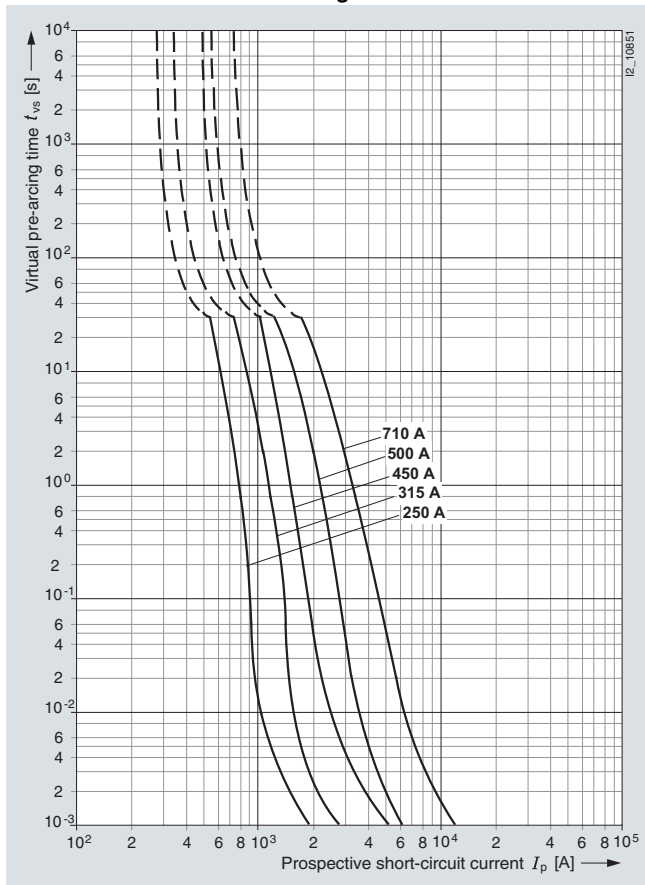

Let-through characteristics (current limitation at 50 Hz)

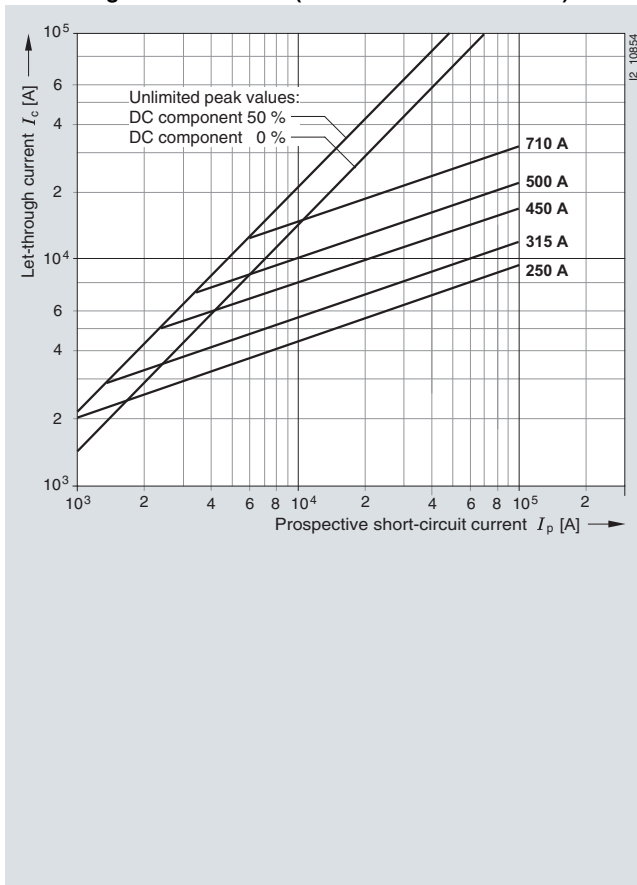

Correction factor k_A for breaking I^2t value

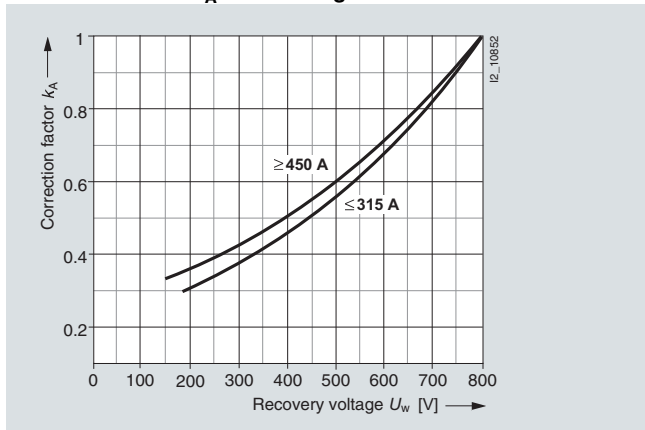

Peak arc voltage

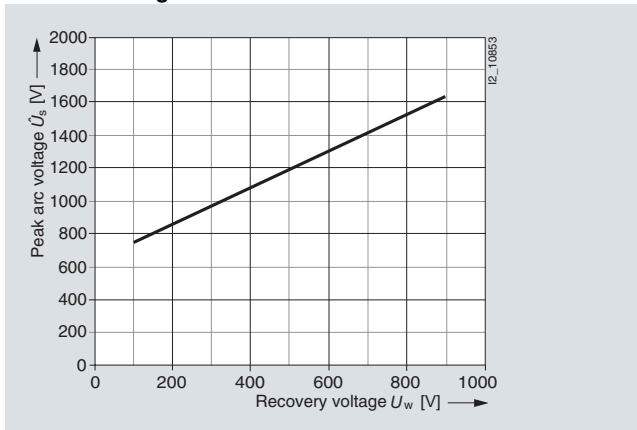

Fuse systems

SITOR semiconductor fuses

LV HRC design, 3NC, 3NE

Series 3NE4 3...-6B, 3NE4 337-6

Operational class: aR
 Rated voltage: 800 V AC
 Rated current: 250 ... 710 A

Time/current characteristics diagram

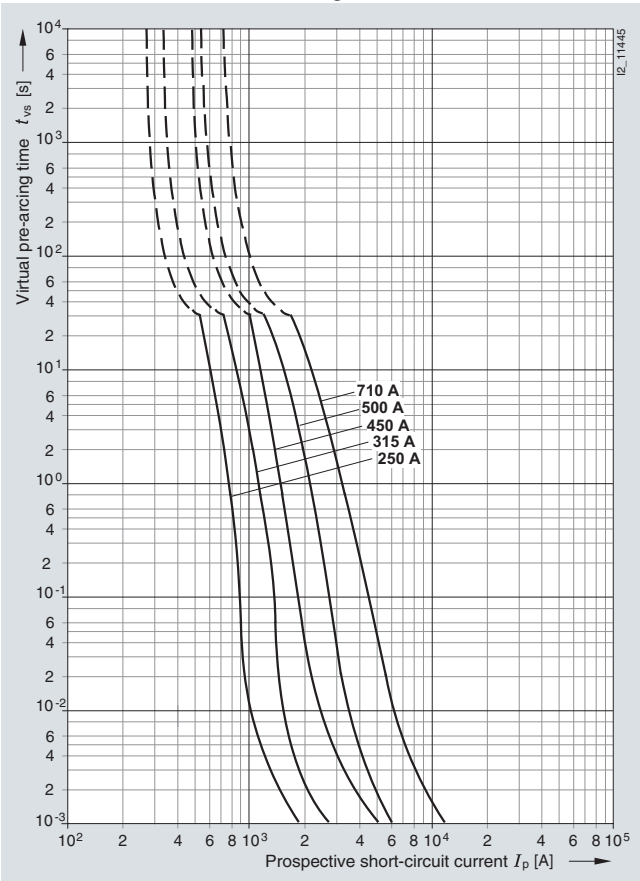

Let-through characteristics (current limitation at 50 Hz)

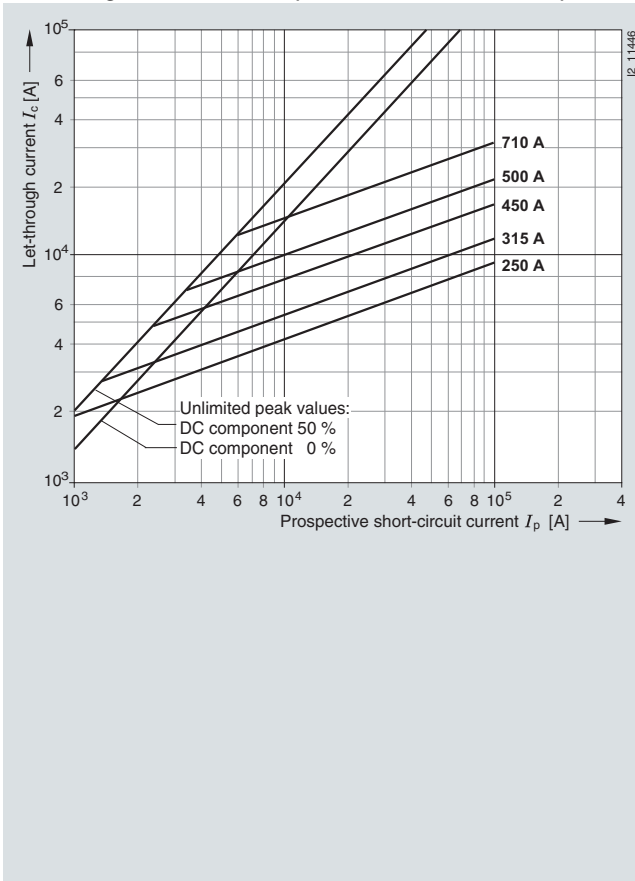

Correction factor k_A for breaking I^2t value

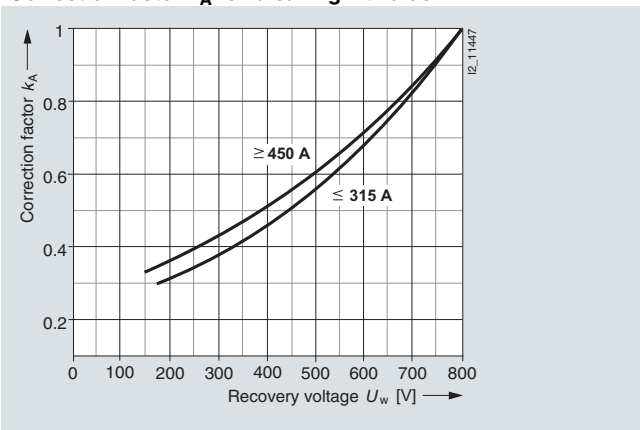

Peak arc voltage

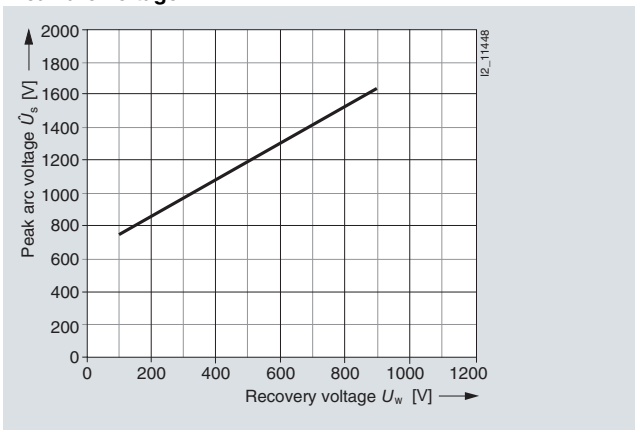

Fuse systems

SITOR semiconductor fuses

LV HRC design, 3NC, 3NE

Series 3NE5 4..

Size: 3
 Operational class: aR
 Rated voltage: 1500 V AC
 Rated current: 160 ... 450 A

Time/current characteristics diagram

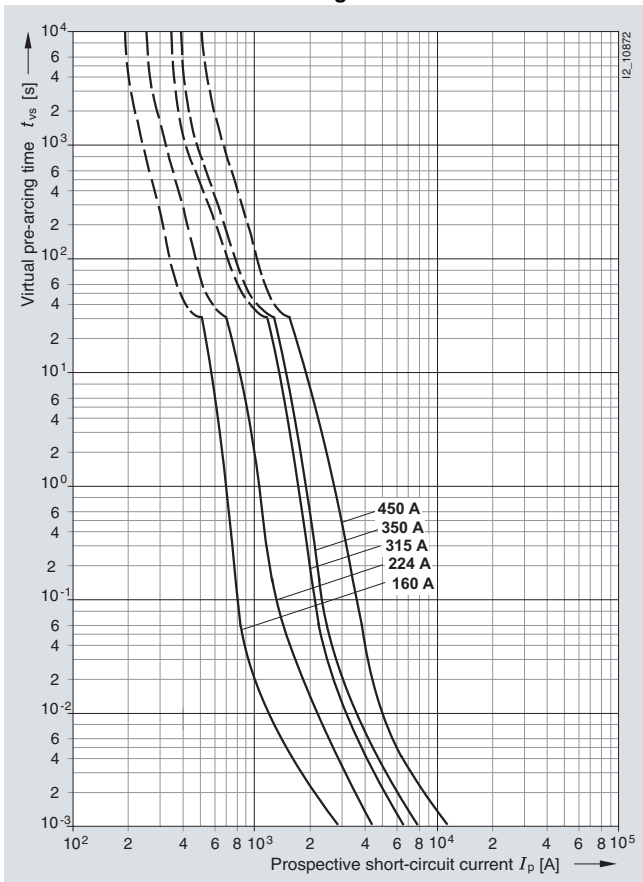

Let-through characteristics (current limitation at 50 Hz)

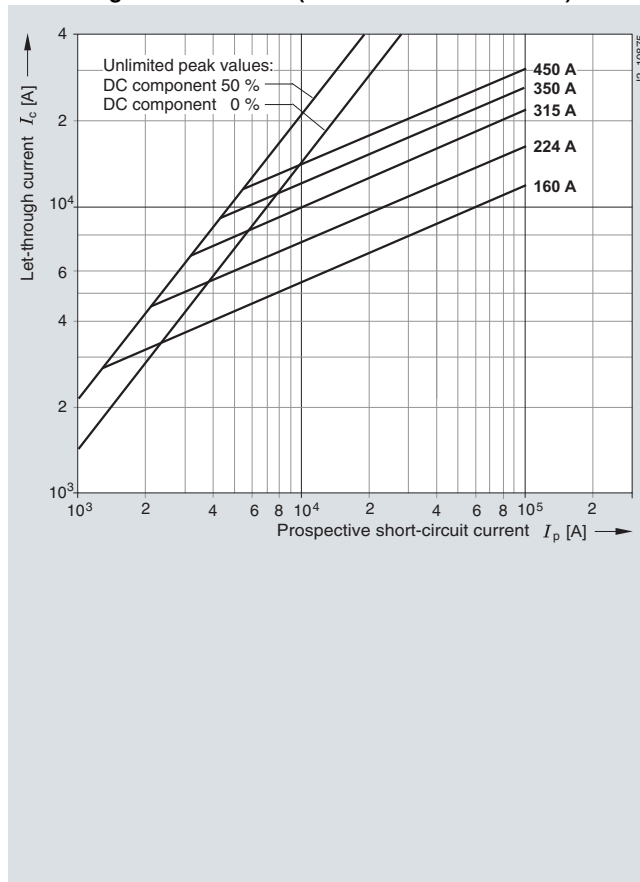

Correction factor k_A for breaking I^2t value

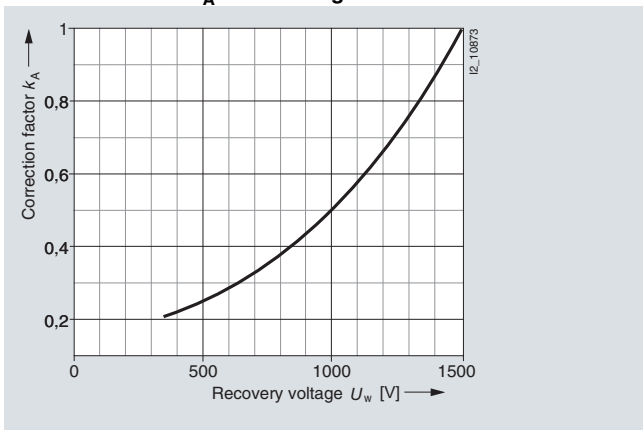

Peak arc voltage

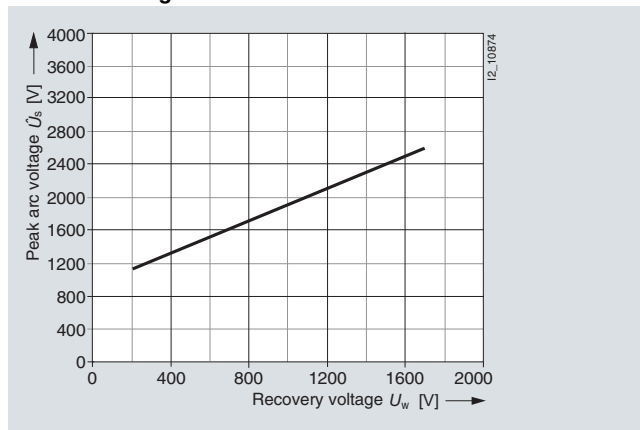

Fuse systems

SITOR semiconductor fuses

LV HRC design, 3NC, 3NE

Series 3NE5 6..

Size: 3
 Operational class: aR
 Rated voltage: 1500 V AC
 Rated current: 250 ... 600 A

Time/current characteristics diagram

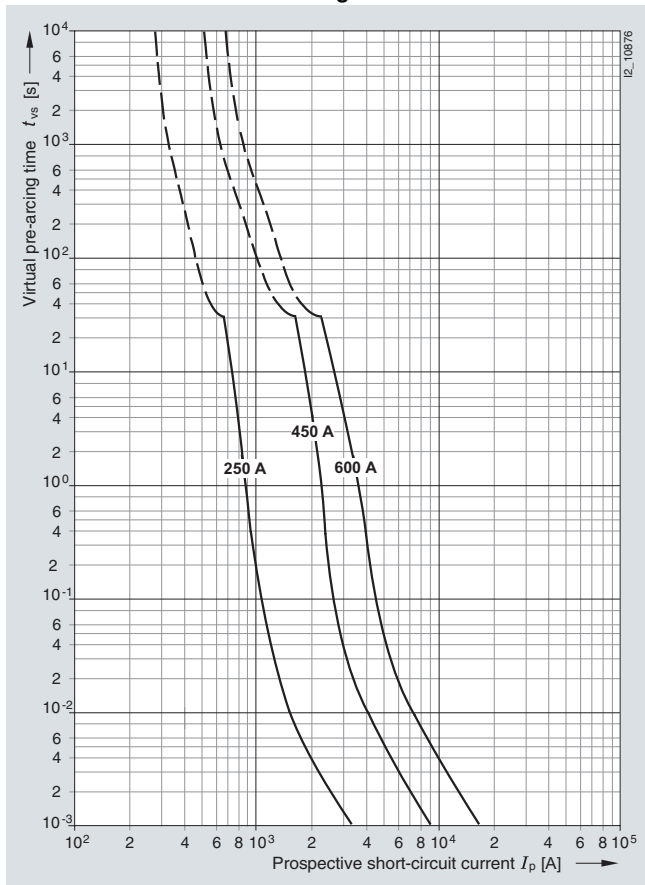

Let-through characteristics (current limitation at 50 Hz)

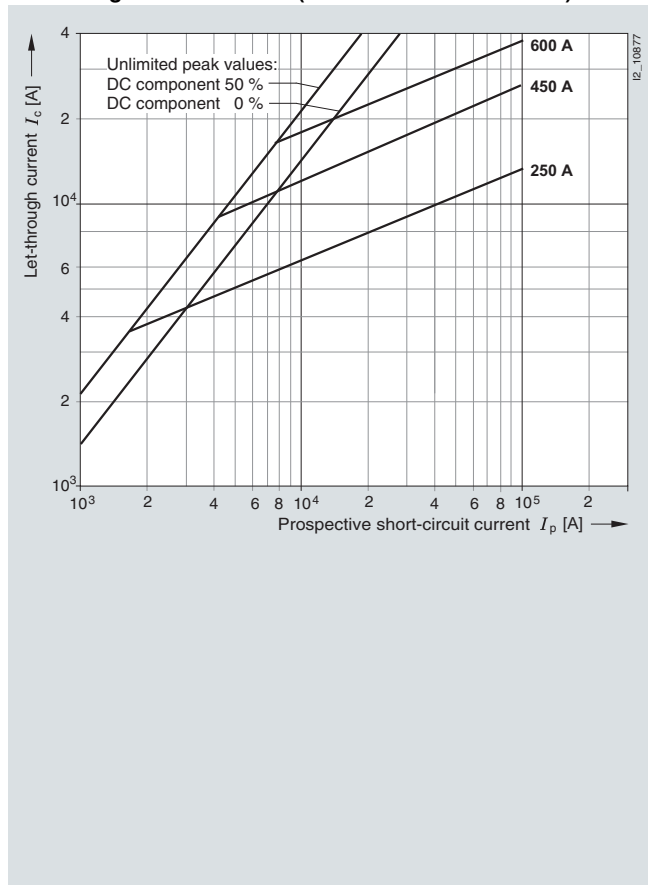

Correction factor k_A for breaking I^2t value

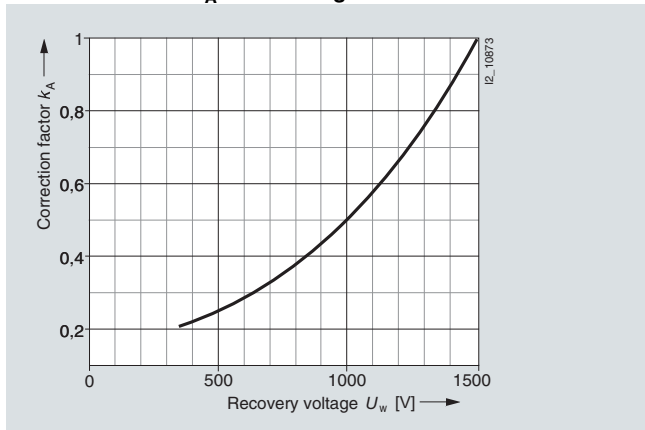

Peak arc voltage

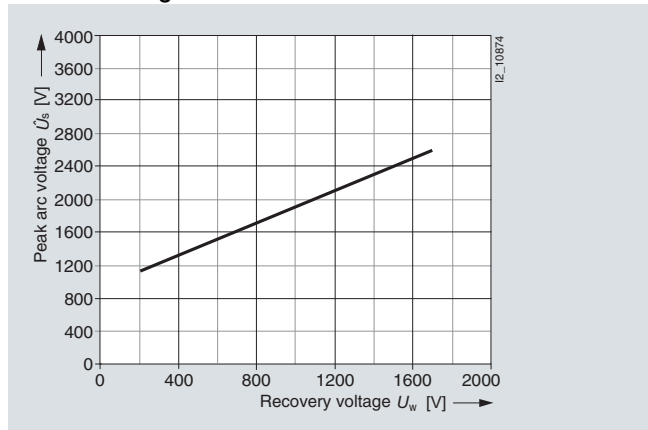

Series 3NE6 4.., 3NE9 4..

Operational class: aR, gR
 Rated voltage: 600 V AC (850 A, 1250 A),
 900 V AC (710 A, 900 A)
 Rated current: 710 ... 1250 A

Time/current characteristics diagrams

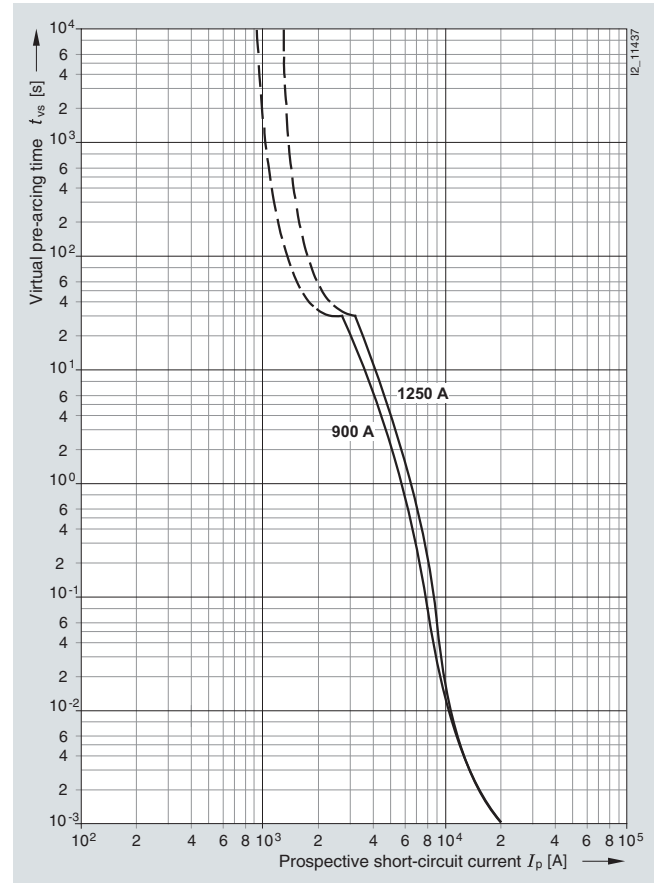
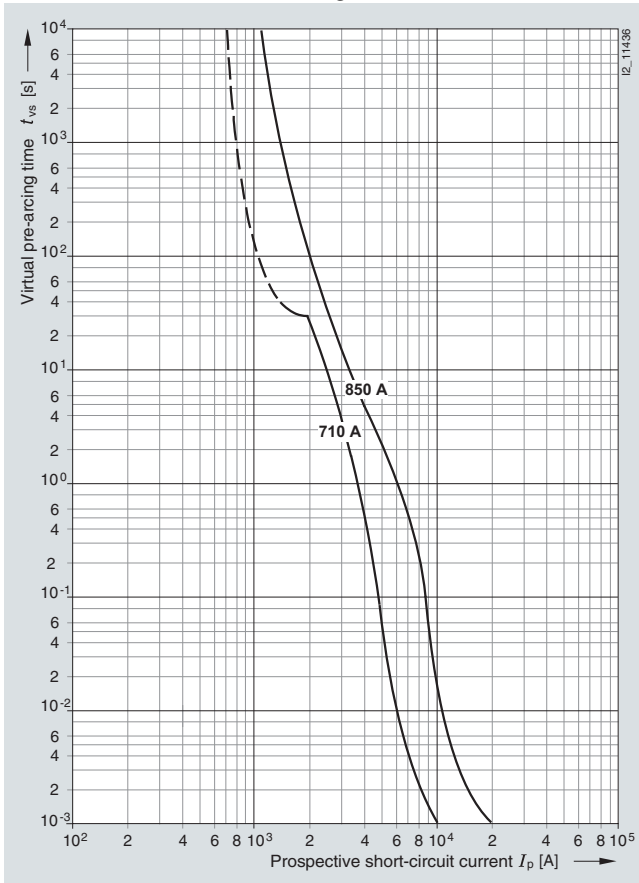

Fuse systems

SITOR semiconductor fuses

LV HRC design, 3NC, 3NE

Series 3NE6 4.., 3NE9 4..

Operational class: aR, gR
 Rated voltage: 600 V AC (850 A, 1250 A),
 900 V AC (710 A, 900 A)
 Rated current: 710 ... 1250 A

Let-through characteristics (current limitation at 50 Hz)

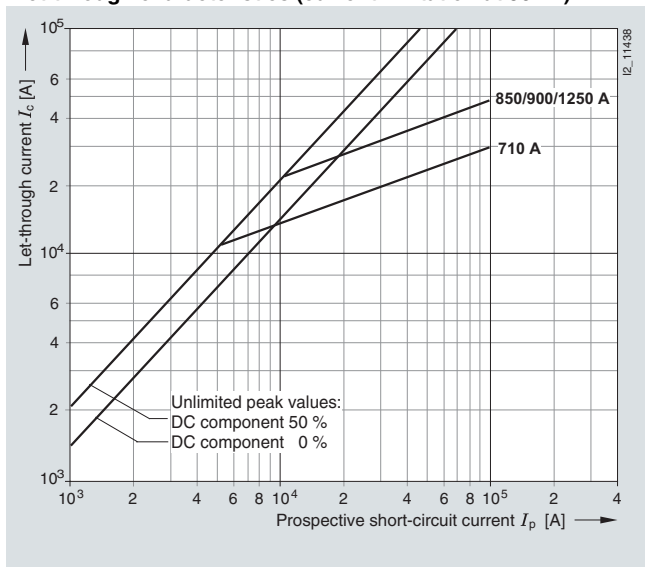

Correction factor k_A for breaking I^2t value

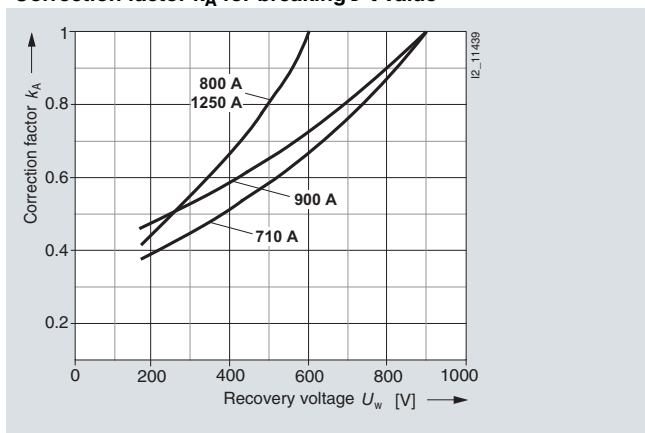

Peak arc voltage

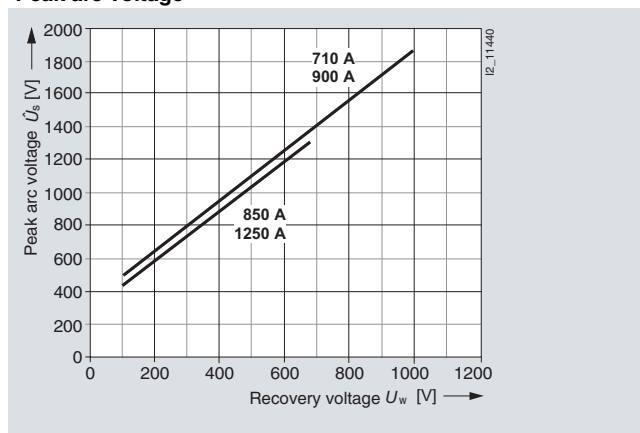

Fuse systems

SITOR semiconductor fuses

LV HRC design, 3NC, 3NE

Series 3NE7 4.., 3NE7 6..

Size: 3
 Operational class: aR
 Rated voltage: 2000 V AC
 Rated current: 200 ... 710 A

Time/current characteristics diagram

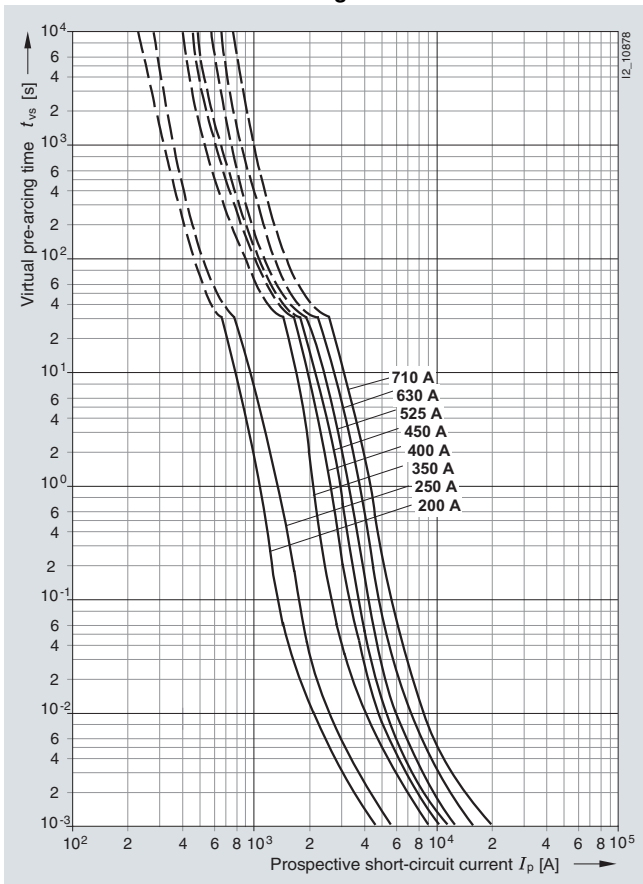

Let-through characteristics (current limitation at 50 Hz)

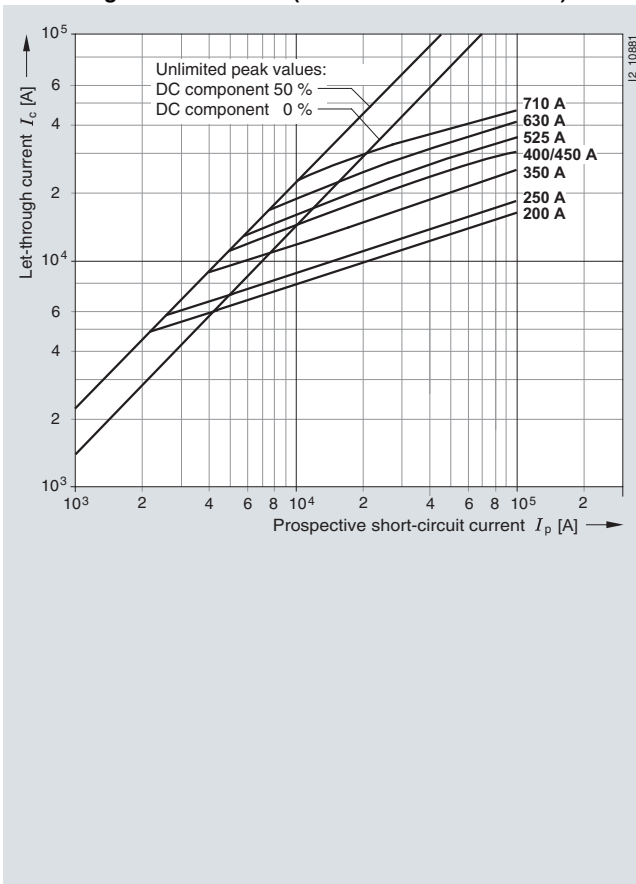

Correction factor k_A for breaking I^2t value

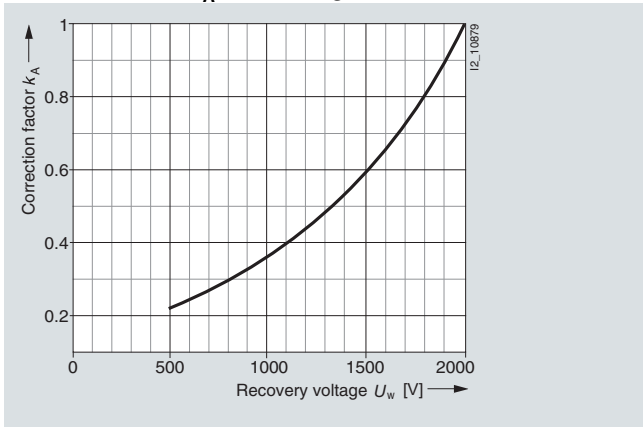

Peak arc voltage

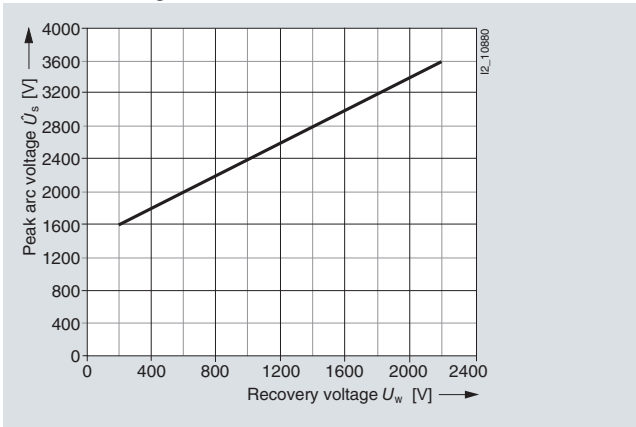

Fuse systems

SITOR semiconductor fuses

LV HRC design, 3NC, 3NE

Series 3NE8 0...1

Size: 00
 Operational class: gR or aR
 Rated voltage: 690 V AC
 Rated current: 25 ... 160 A

Time/current characteristics diagram

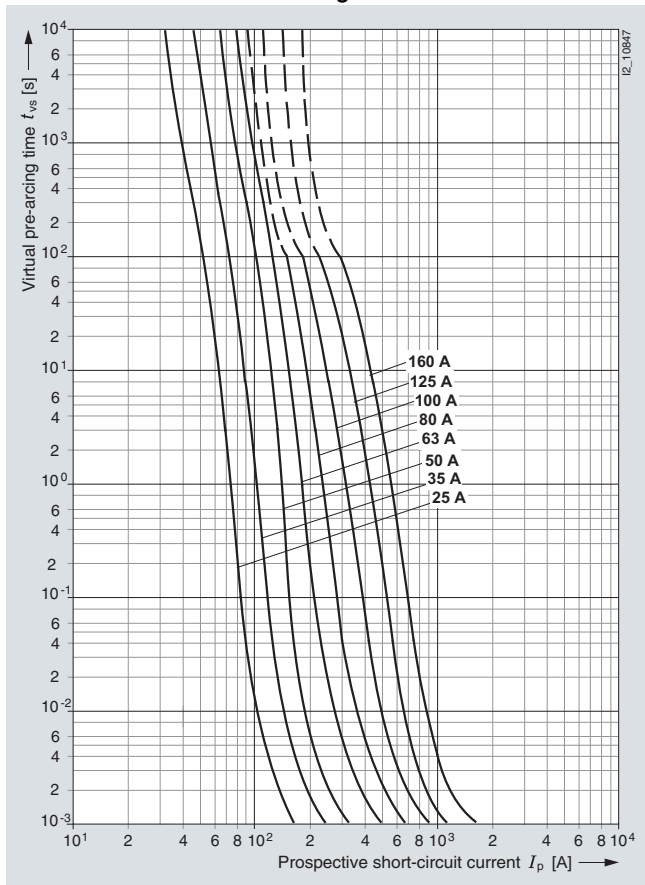

Let-through characteristics (current limitation at 50 Hz)

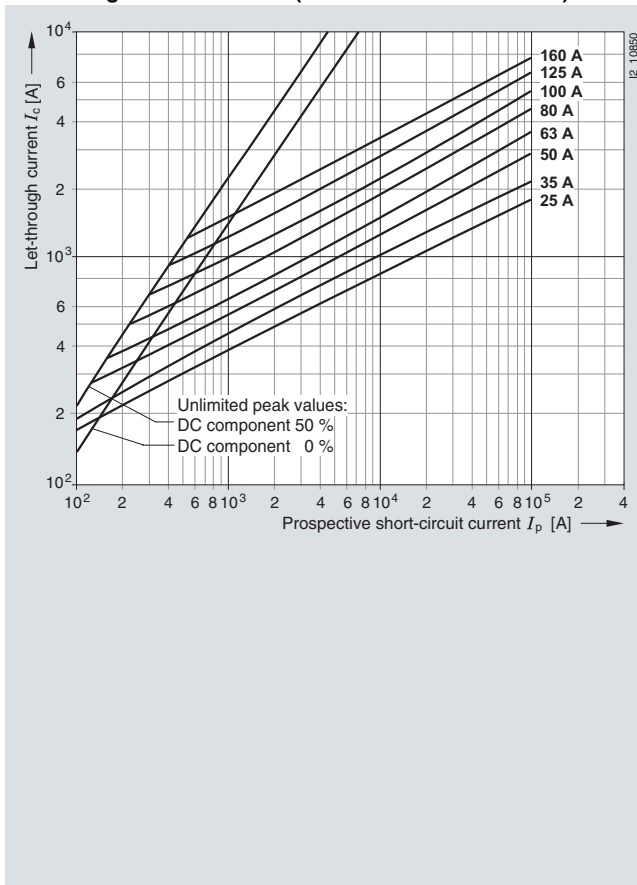

Correction factor k_A for breaking I^2t value

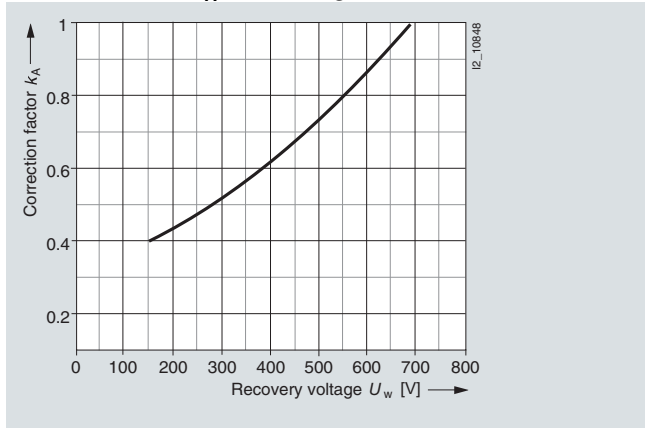

Peak arc voltage

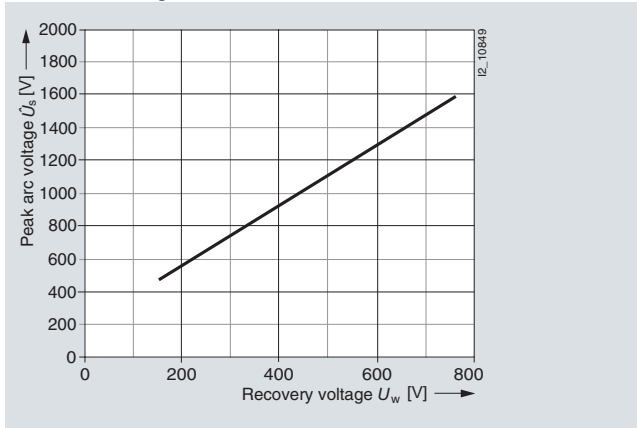

Series 3NE8 70.-1, 3NE8 71.-1

Size: 000
 Operational class: gR or aR
 Rated voltage: 690 V AC/700 V DC
 Rated current: 20 ... 63 A

Time/current characteristics diagram

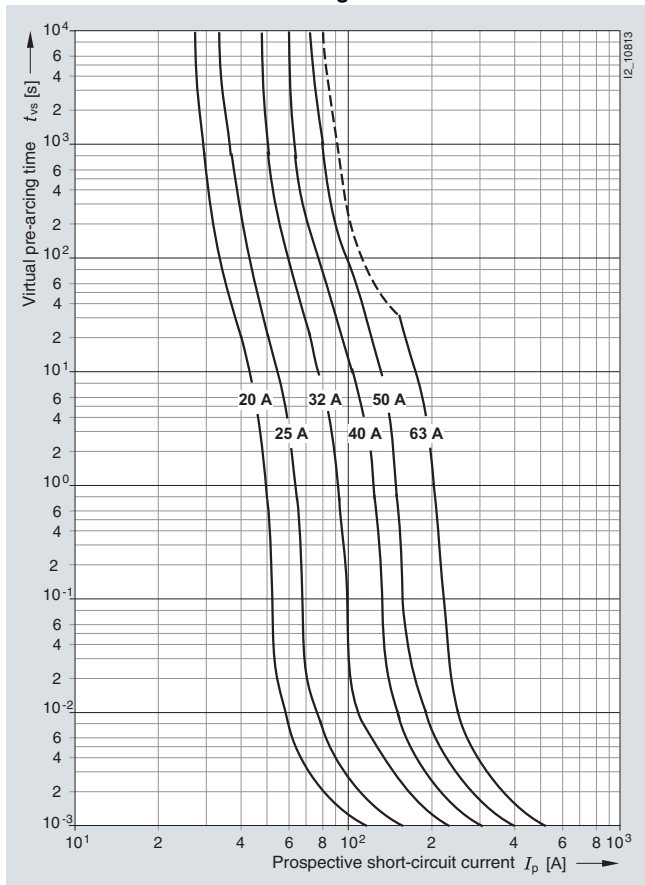

Let-through characteristics (current limitation at 50 Hz)

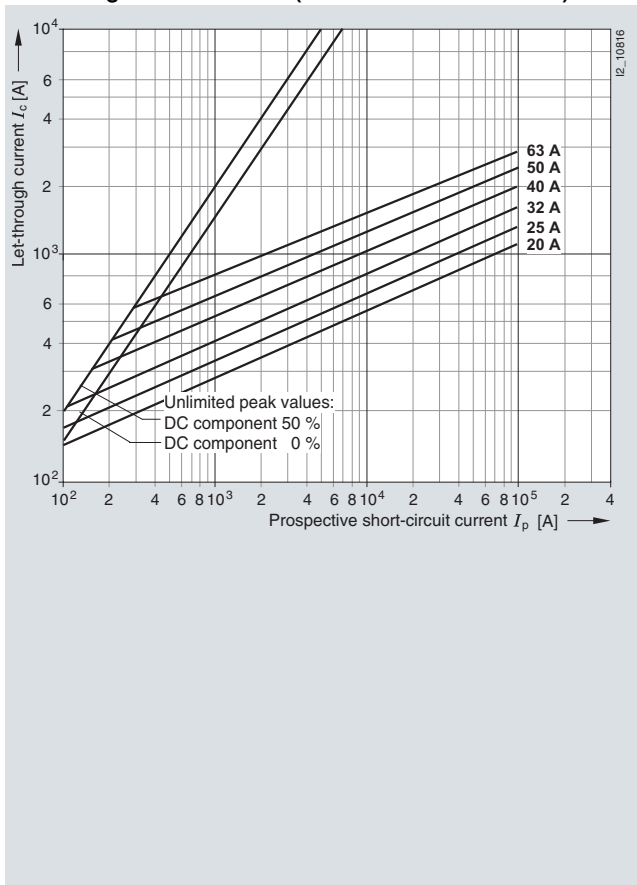

Correction factor k_A for breaking I^2t value

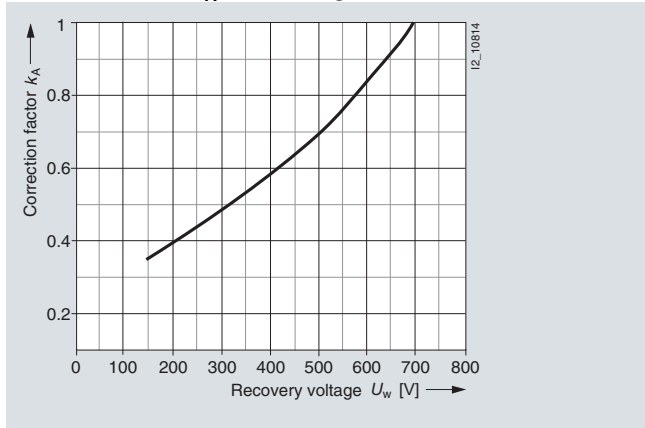

Peak arc voltage

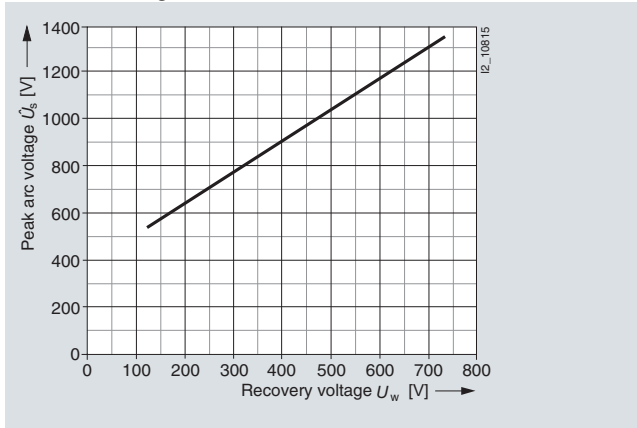

Fuse systems

SITOR semiconductor fuses

LV HRC design, 3NC, 3NE

Series 3NE8 72.-1, 3NE8 731-1

Size: 000
 Operational class: aR
 Rated voltage: 690 V AC/700 V DC according to UL
 Rated current: 80 ... 315 A

Time/current characteristics diagram

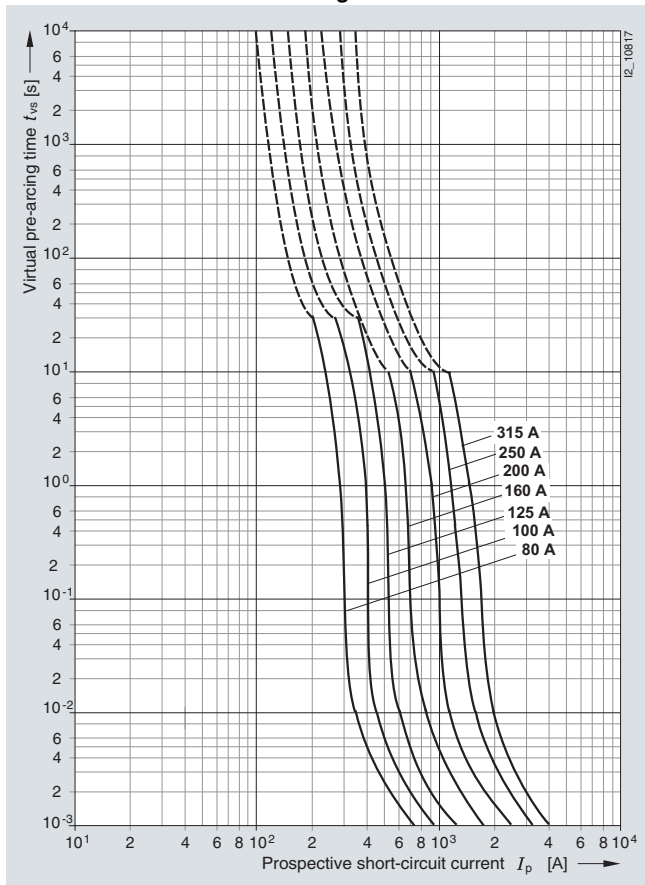

Let-through characteristics (current limitation at 50 Hz)

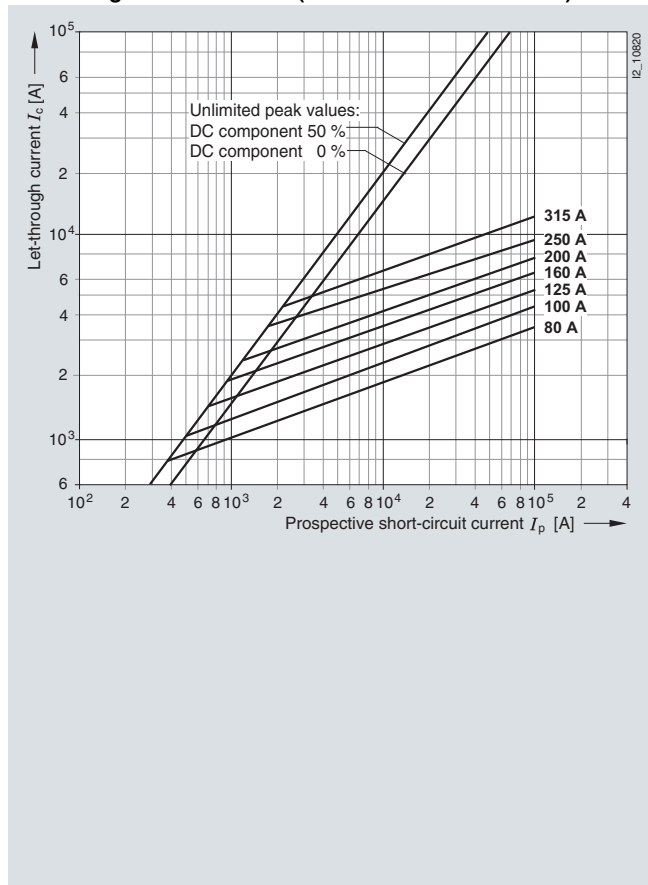

Correction factor k_A for breaking I^2t value

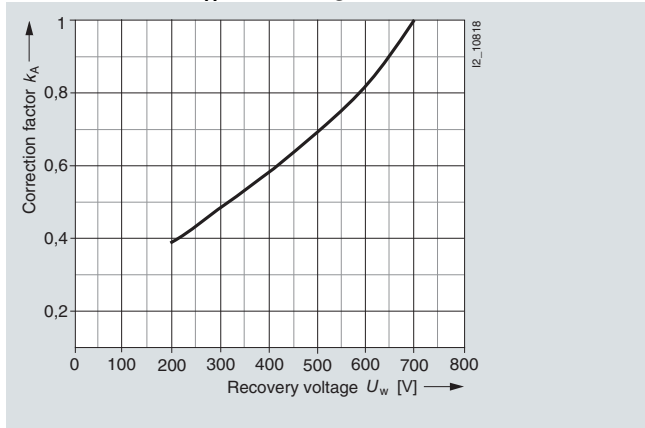

Peak arc voltage

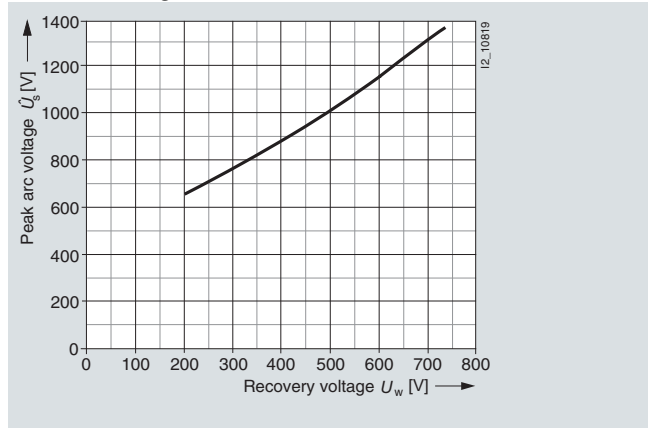

Series 3NE9 63.

Size: 3
 Operational class: aR
 Rated voltage: 2500 V AC
 Rated current: 400 ... 630 A

Time/current characteristics diagram

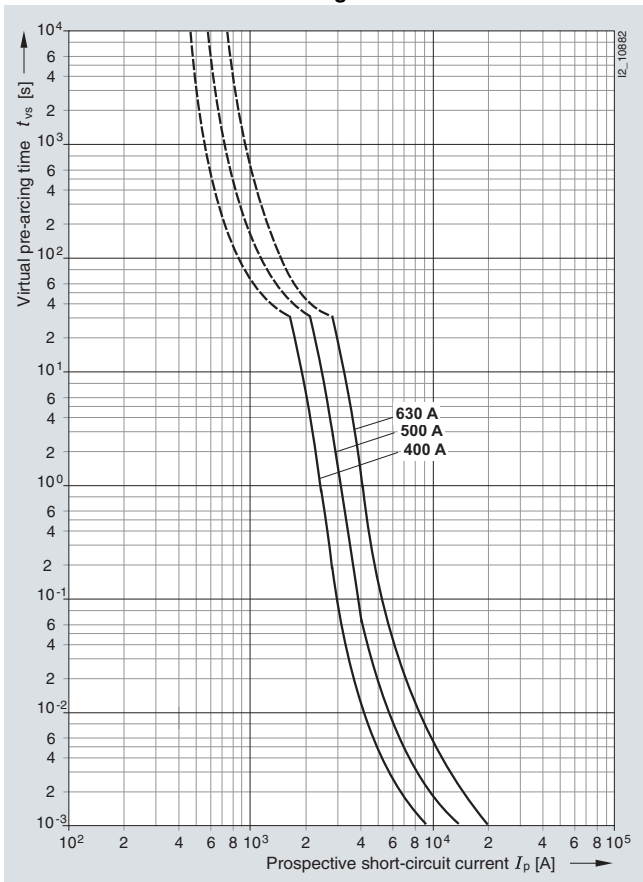

Let-through characteristics (current limitation at 50 Hz)

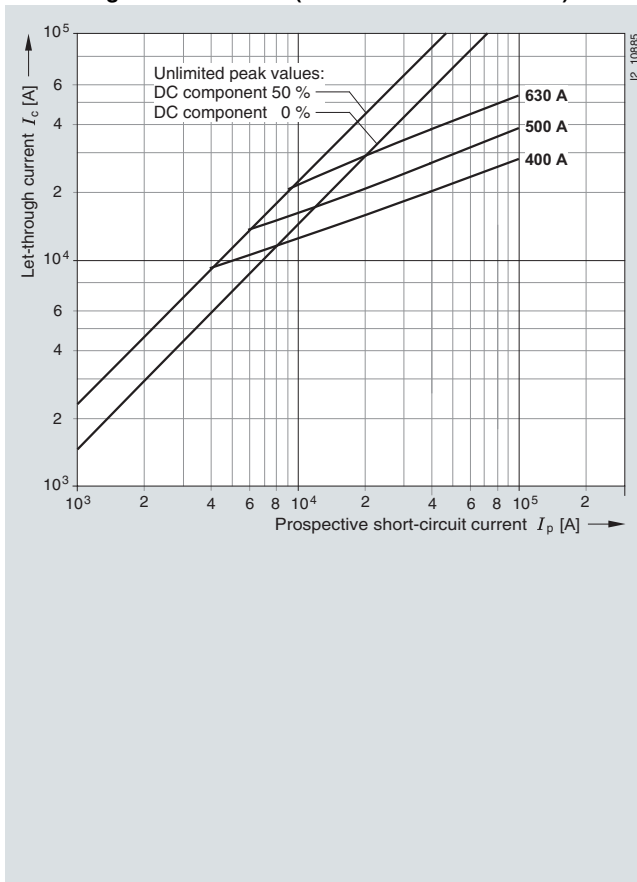

Correction factor k_A for breaking I^2t value

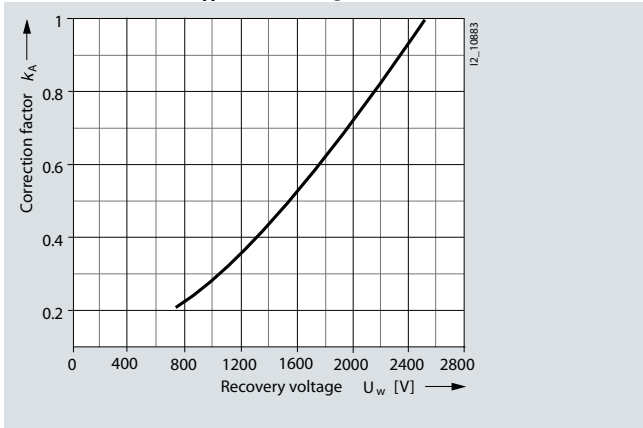

Peak arc voltage

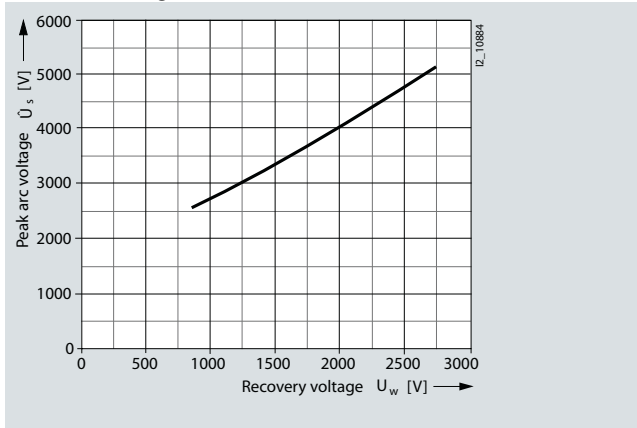

Fuse systems

SITOR semiconductor fuses

Cylindrical fuse design, 3NC1, 3NC2

Overview

SITOR cylindrical fuses protect power semiconductors from the effects of short circuits because the super quick disconnect characteristic is far quicker than that of conventional fuses. They protect expensive devices and system components such as semiconductor contactors, electronic relays (solid state), converters with fuses in the input and in the DC link, UPS systems and soft starters for motors up to 100 A.

The cylindrical design is approved for industrial applications. The cylindrical fuse links comply with IEC 60269.

Cylindrical fuse holders also comply with IEC 60269 and UL 512. The cylindrical fuse holders for 10 x 38 mm and 14 x 51 mm have been tested and approved as fuse switch disconnectors and the cylindrical fuse holders for 22 x 58 mm as

fuse disconnectors according to the switching device standard IEC 60947-3. The utilization category and the tested current and voltage values are specified in the Table "Technical Specifications".

The cylindrical fuse holders have been specially developed for the application of SITOR fuse links with regard to heat tolerance and heat dissipation and are therefore not recommended for standard applications.

Cylindrical fuse bases do not offer the same comprehensive touch protection as the fuse holders, but have better heat dissipation. The single-pole cylindrical fuse bases for 14 x 51 mm and 22 x 58 mm allow modular expansion to multipole bases.

Technical specifications

Sizes	mm x mm	10 x 38	14 x 51	22 x 58
		Cylindrical fuse links 3NC1 0, 3NC1 4, 3NC2 2		
Standards		IEC 60269-4; UL 248-13; CSA C22.2 No. 248.13		
Approvals		UL 248-13; UL File No. E167357; CSA C22.2 No. 248.13		
		Fuse holders, fuse bases 3NC1, 3NC2		
Standards		IEC 60269-2; EN 60947-3; UL 512; CSA C22.2 No. 39-M		
Approvals		UL 512; UL File No. E220063; CSA C22.2 No. 39-M		
Rated voltage	V AC	690		
Rated current I_n	A	32	50	100
Max. power dissipation of fuse links (conductor cross-section used)	W	3 (6 mm ²) 4.3 (10 mm ²)	5 (10 mm ²) 6.5 (25 mm ²)	9.5 (35 mm ²) 11 (50 mm ²)
Feeder terminals	mm ²	1.5 ... 25	1.5 ... 35	4 ... 50
Conductor cross-sections				
• Solid and stranded	mm ²	1.5 ... 25	1.5 ... 35	4 ... 50
• AWG cables, solid and stranded	AWG	18 ... 4	14 ... 2	10 ... 1/0
Utilization category	Acc. to IEC 60947-3	22B/32 A/400 V AC 22B/10 A/690 V AC	22B/50 A/400 V AC 22B/20 A/690 V AC	20B/690 V AC
Rated conditional short-circuit current				
• At 400 V	kA	50 (32 A gG)	100 (50 A gG)	100 (100 A gG) 80 (80 A gG)

Fuse systems

SITOR semiconductor fuses

Cylindrical fuse design, 3NC1, 3NC2

Load rating of SITOR cylindrical fuses

Cylinder	Operational class (IEC 60269)	Rated voltage U_n		Rated current I_n	Melting I^2t value I^2t_s ($t_{vs} = 1$ ms)	Breaking I^2t value I^2t_a at U_n	Temperature rise at I_n body center	Power dissipation at I_n	Weight approx.
		V AC	V DC						
3NC1 003	aR	600	400	3	3	8	30	1.2	0.01
3NC1 006	aR	600	400	6	4	20	30	1.5	0.01
3NC1 008	aR	600	400	8	6	30	25	2	0.01
3NC1 010	aR	600	400	10	9	60	40	2.5	0.01
3NC1 012	aR	600	400	12	15	110	50	3	0.01
3NC1 016	aR	600	400	16	25	150	60	3.5	0.01
3NC1 020	aR	600	400	20	34	200	80	4.8	0.01
3NC1 025	aR	600	400	25	60	250	90	6	0.01
3NC1 032	aR	600	400	32	95	500	110	7.5	0.01
3NC1 401	aR	660	700	1		1.2	90	5	0.02
3NC1 402	aR	660	700	2		10	30	3	0.02
3NC1 403	aR	660	700	3		15	40	2.5	0.02
3NC1 404	aR	660	700	4		25	50	3	0.02
3NC1 405	aR	690	700	5	1.6	9	20	1.5	0.02
3NC1 406	aR	690	700	6		12	30	1.5	0.02
3NC1 410	aR	690	700	10	3.6	20	50	4	0.02
3NC1 410-5	aR	690	700	10	3.6	90	50	4	0.02
3NC1 415	aR	690	700	15	10	75	60	5.5	0.02
3NC1 415-5	aR	690	700	15	9	100	60	5.5	0.02
3NC1 420	aR	690	700	20	26	120	70	6	0.02
3NC1 420-5	aR	690	700	20	26	500	70	6	0.02
3NC1 425	aR	690	700	25	44	250	80	7	0.02
3NC1 425-5	aR	690	700	25	47	400	80	7	0.02
3NC1 430	aR	690	700	30	58	300	80	9	0.02
3NC1 430-5	aR	690	700	30	58	500	80	9	0.02
3NC1 432	aR	690	700	32	95	700	80	7.6	0.02
3NC1 432-5	aR	690	700	32	68	600	80	7.6	0.02
3NC1 440	aR	690	700	40	110	900	100	8	0.02
3NC1 440-5	aR	690	700	40	84	900	100	8	0.02
3NC1 450	aR	690	700	50	220	1800	110	9	0.02
3NC1 450-5	aR	690	700	50	200	2000	110	9	0.02
3NC2 200	aR	600	700	100	1250	8000	110	16	0.06
3NC2 200-5	aR	600	700	100	1100	8500	110	16	0.06
3NC2 220	aR	690	700	20	34	220	40	4.6	0.06
3NC2 220-5	aR	690	700	20	19	240	40	5	0.06
3NC2 225	aR	690	700	25	50	300	50	5.6	0.06
3NC2 225-5	aR	690	700	25	34	350	50	6	0.06
3NC2 232	aR	690	700	32	80	450	65	7	0.06
3NC2 232-5	aR	690	700	32	54	500	65	8	0.06
3NC2 240	aR	690	700	40	100	700	80	8.5	0.06
3NC2 240-5	aR	690	700	40	68	800	80	9	0.06
3NC2 250	aR	690	700	50	185	1350	90	9.5	0.06
3NC2 250-5	aR	690	700	50	135	1500	90	9.5	0.06
3NC2 263	aR	690	700	63	310	2600	100	11	0.06
3NC2 263-5	aR	690	700	63	280	3000	100	11	0.06
3NC2 280	aR	690	700	80	620	5500	110	13.5	0.06
3NC2 280-5	aR	690	700	80	600	6000	110	13.5	0.06

Load rating of SITOR cylindrical fuses without strikers in fuse holders - can be used as fuse switch disconnectors ¹⁾

For SITOR fuse links	Rated voltage	Rated current I_n	Required conductor cross-section Cu	Cylindrical fuse bases						Fuse holders – can be used as fuse switch disconnectors ¹⁾						
				1-pole Type	$I_{max 2)$	2-pole Type	$I_{max 2)$	3-pole Type	$I_{max 2)$	1-pole Type	$I_{max 2)$	2-pole Type	$I_{max 2)$	3-pole Type	$I_{max 2)$	
	V AC	A	mm ²		A		A		A		A		A		A	
Size 10 x 38																
3NC1 003	600	3	1	3NC1 038-1	3	3NC1038-2/	3	3NC1 038-3/	3	3NC1 091	3	3NC1 092/	3	3NC1 093/	3	
3NC1 006		6	1		6	2 x	6	3 x	6		6	2 x	6	3 x	6	
3NC1 008		8	1		8	3NC1 038-1	8	3NC1 038-1	8		8	3NC1 091	8	3NC1 091	8	
3NC1 010		10	1.5		10		10		10		10		10		10	
3NC1 012		12	1.5		12		12		12		12		12		12	
3NC1 016		16	2.5		16		16		16		16		16		16	
3NC1 020		20	2.5		20		20		20		20		20		20	
3NC1 025		25	4		25		23		21		25		24		22	
3NC1 032		32	6		32		30		28		32		30		28	

Fuse systems

SITOR semiconductor fuses

Cylindrical fuse design, 3NC1, 3NC2

For SITOR fuse links	Rated voltage V AC	Rated current I_n A	Required conductor cross-section Cu mm ²	Cylindrical fuse bases						Fuse holders – can be used as fuse switch disconnectors ¹⁾							
				1-pole Type	$I_{max}^{2)}$ A	2-pole Type	$I_{max}^{2)}$ A	3-pole Type	$I_{max}^{2)}$ A	1-pole Type	$I_{max}^{2)}$ A	2-pole Type	$I_{max}^{2)}$ A	3-pole Type	$I_{max}^{2)}$ A		
Size 14 x 51																	
3NC1 401	660	1	1	3NC1 451-1	1	–	–	–	3NC1 491	1	3NC1 492/ 2 x 3NC1 491	1	3NC1 493/ 3 x 3NC1 491	1			
3NC1 402		2	1		2	–	–	–		2		2		2	2	2	
3NC1 403		3	1		3	–	–	–		3		3		3	3	3	
3NC1 404		4	1		4	–	–	–		4		4		4	4	4	
3NC1 405	690	5	1		5	–	–	–		5		5		5	5	5	
3NC1 406		6	1		6	–	–	–		6		6		6	6	6	
3NC1 410		10	1.5		10	–	–	–		10		10		10	10	10	
3NC1 415		15	1.5		15	–	–	–		15		15		15	15	15	
3NC1 420		20	2.5		20	–	–	–		20		20		20	20	20	
3NC1 425		25	4		25	–	–	–		25		24		24	22	22	
3NC1 430		30	6		30	–	–	–		28		27		27	25	25	
3NC1 432		32	6		32	–	–	–		32		32		32	32	32	
3NC1 440		40	10		40	–	–	–		40		39		39	38	38	
3NC1 450		50	10		50	–	–	–		48		46		46	44	44	
Size 22 x 58																	
3NC2 220	690	20	2.5		3NC2 258-1	20	–	–		–		3NC2 291		20	3NC2 292/ 2 x 3NC2 291	20	3NC2 293/ 3 x 3NC2 291
3NC2 225		25	4	25		–	–	–	25	25	25		25	25			
3NC2 232		32	6	32		–	–	–	32	32	32		32	32			
3NC2 240		40	10	40		–	–	–	40	39	39		38	38			
3NC2 250		50	10	50		–	–	–	50	48	48		44	44			
3NC2 263		63	16	63		–	–	–	60	58	58		56	56			
3NC2 280		80	25	80		–	–	–	74	71	71		69	69			
3NC2 200	600	100	35	100		–	–	–	95	90	90		85	85			

Fuse tongs: 3NC1 000.

¹⁾ Fuse holders according to IEC 60269-3, UL 512
Fuse switch disconnectors (10 x 38, 14 x 51) acc. to IEC 60947-3
Fuse disconnectors (22 x 58) according to IEC 60947-3.

²⁾ The values I_{max} apply for "stand-alone operation". If several devices are butt-mounted and/or subject to unfavorable cooling conditions, these values may be reduced still further. With a larger conductor cross-section, values higher than I_{max} are.

Load rating of SITOR cylindrical fuses without strikers in fuse holders - can be used as fuse switch disconnectors¹⁾

For SITOR fuse links	Rated voltage V AC	Rated current I_n A	Required conductor cross-section Cu mm ²	Fuse holders - can be used as fuse switch disconnectors ¹⁾								
				1-pole Type	$I_{max}^{2)}$ A	2-pole Type	$I_{max}^{2)}$ A	3-pole Type	$I_{max}^{2)}$ A			
Size 14 x 51												
3NC1 410-5	690	10	1.5	3NC1 491	10	3NC1 492/ 2 x 3NC1 491-5	10	3NC1 493/ 3 x 3NC1 491-5	10			
3NC1 415-5		15	1.5		15		15		15			
3NC1 420-5		20	2.5		20		20		20			
3NC1 425-5		25	4		25		25		25			
3NC1 430-5		30	6		30		30		30			
3NC1 432-5		32	6		32		32		31			
3NC1 440-5		40	10		38		35		34			
3NC1 450-5		50	10		48		46		44			
Size 22 x 58												
3NC2 220-5	690	20	2.5		3NC2 291		20		3NC2 292/ 2 x 3NC2 291-5	20	3NC2 293/ 3 x 3NC2 291-5	20
3NC2 225-5		25	4	25		25	25					
3NC2 232-5		32	6	32		31	30					
3NC2 240-5		40	10	40		39	37					
3NC2 250-5		50	10	45		43	42					
3NC2 263-5		63	16	59		55	52					
3NC2 280-5		80	25	71		69	68					
3NC2 200-5	600	100	35	94		90	85					

¹⁾ Fuse holders according to IEC 60269-3, UL 512
Fuse switch disconnectors (10 x 38, 14 x 51) acc. to IEC 60947-3
Fuse disconnectors (22 x 58) according to IEC 60947-3.

The values I_{max} apply for "stand-alone operation". If several devices are butt-mounted and/or subject to unfavorable cooling conditions, these values may be reduced still further. With a larger conductor cross-section, values higher than I_{max} are.

Dimensional drawings

Cylindrical fuse links

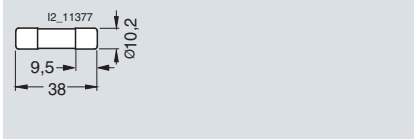

3NC1 0..

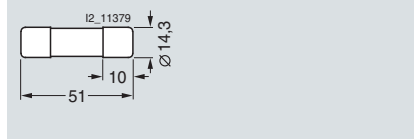

3NC1 4..

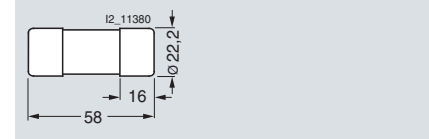

3NC2 2..

Cylindrical fuse holders

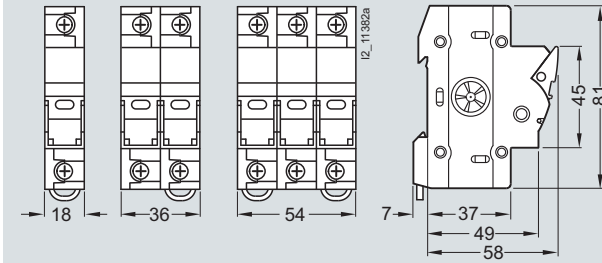

3NC1 09.

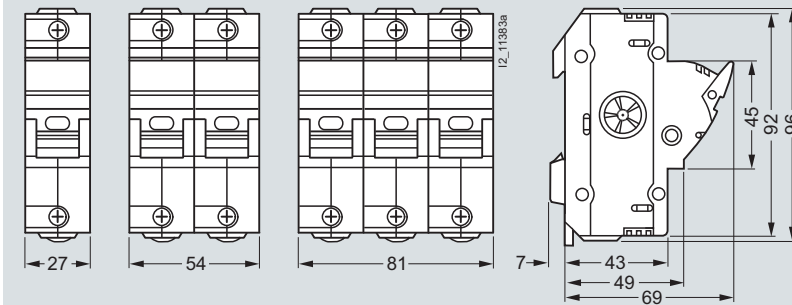

3NC1 49.

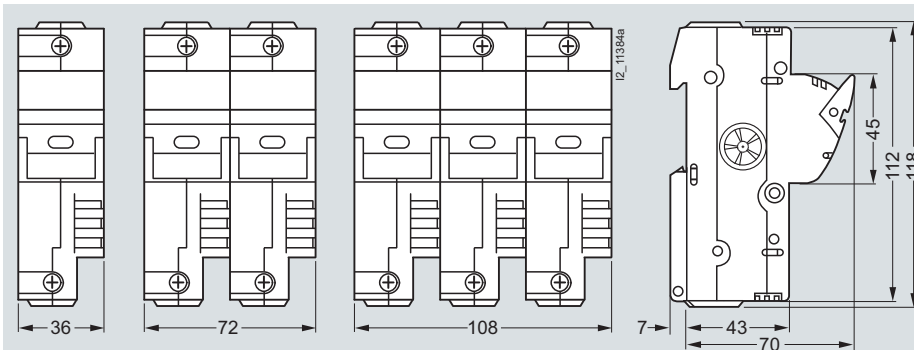

3NC1 29.

Fuse systems

SITOR semiconductor fuses

Cylindrical fuse design, 3NC1, 3NC2

Cylindrical fuse holders with signaling switch

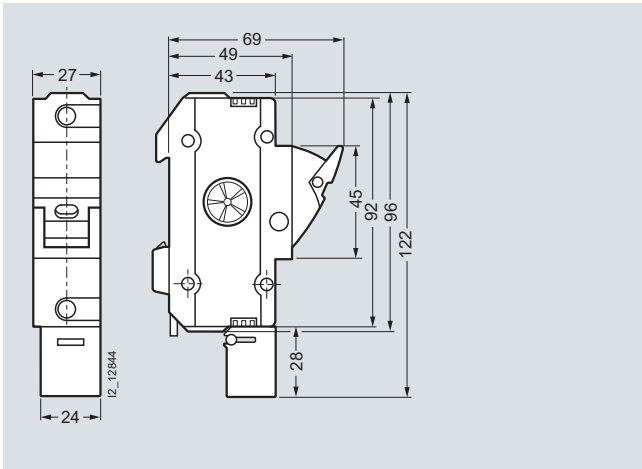

3NC1 491-5

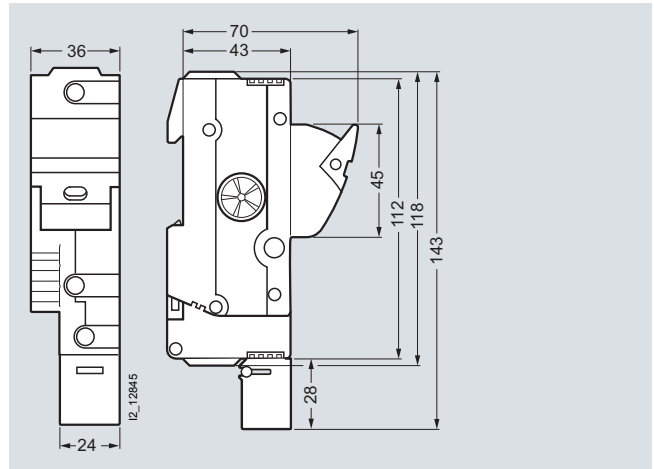

3NC1 291-5

Cylindrical fuse bases

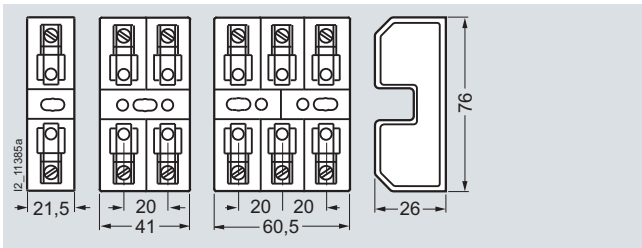

3NC1 038-1 to 3NC1 038-3

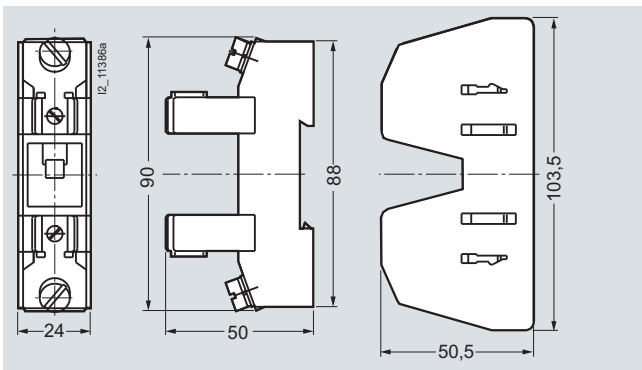

3NC1 451-1

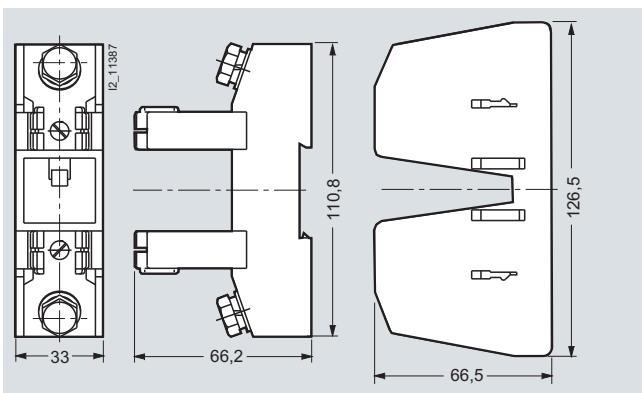

3NC2 258-1

Characteristic curves

Series 3NC1 0

Size: 10 mm × 38 mm
 Operational class: aR
 Rated voltage: 600 V AC/400 V DC
 Rated current: 3 ... 32 A

Time/current characteristics diagram

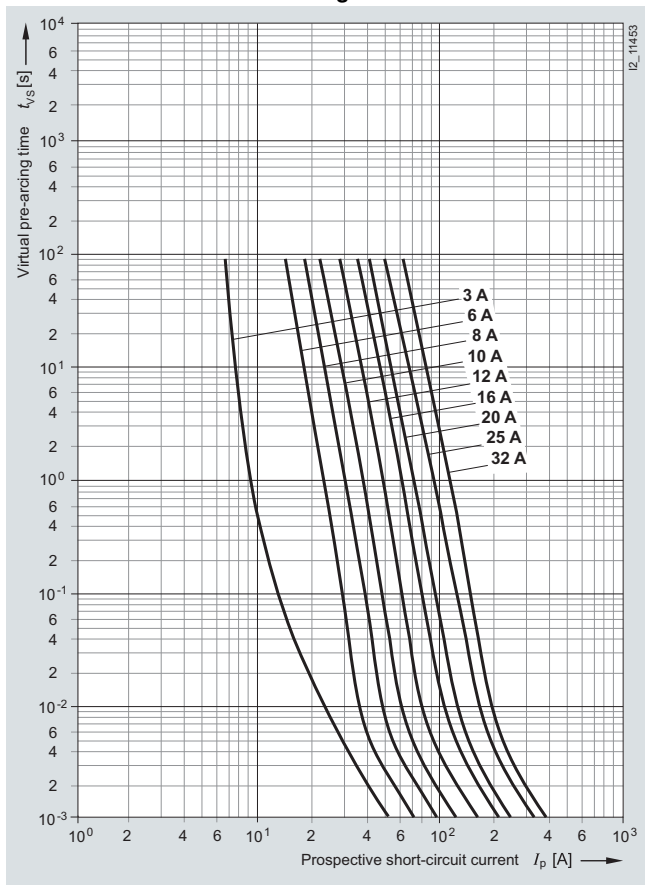

Let-through characteristics (current limitation at 50 Hz)

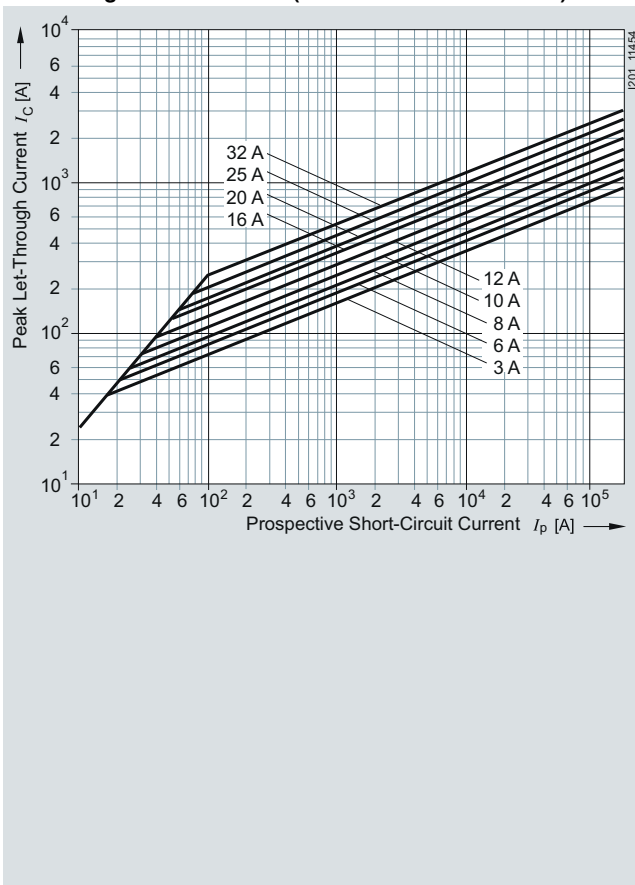

Correction factor k_A for breaking I^2t value

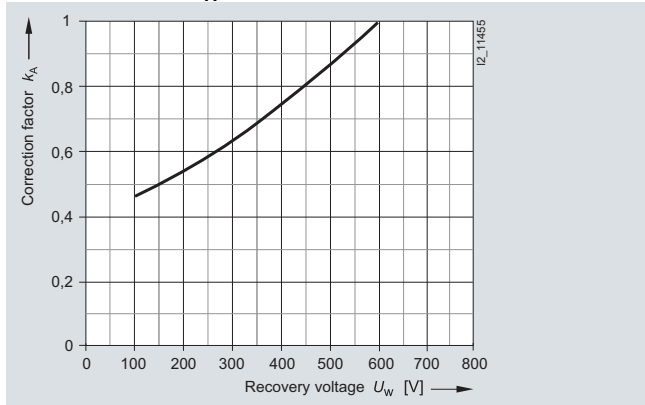

Peak arc voltage

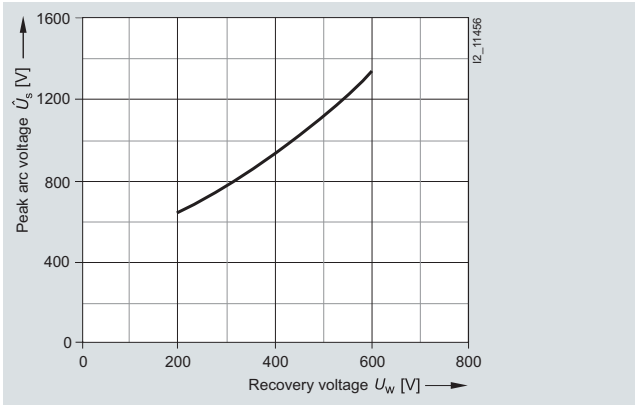

Fuse systems

SITOR semiconductor fuses

Cylindrical fuse design, 3NC1, 3NC2

Series 3NC1 4

Size: 14 mm × 51 mm
 Operational class: aR
 Rated voltage: 660 V AC/700 V DC (1 ... 4 A);
 690 V AC/700 V DC (5 ... 10 A)
 Rated current: 1 ... 10 A

Time/current characteristics diagram

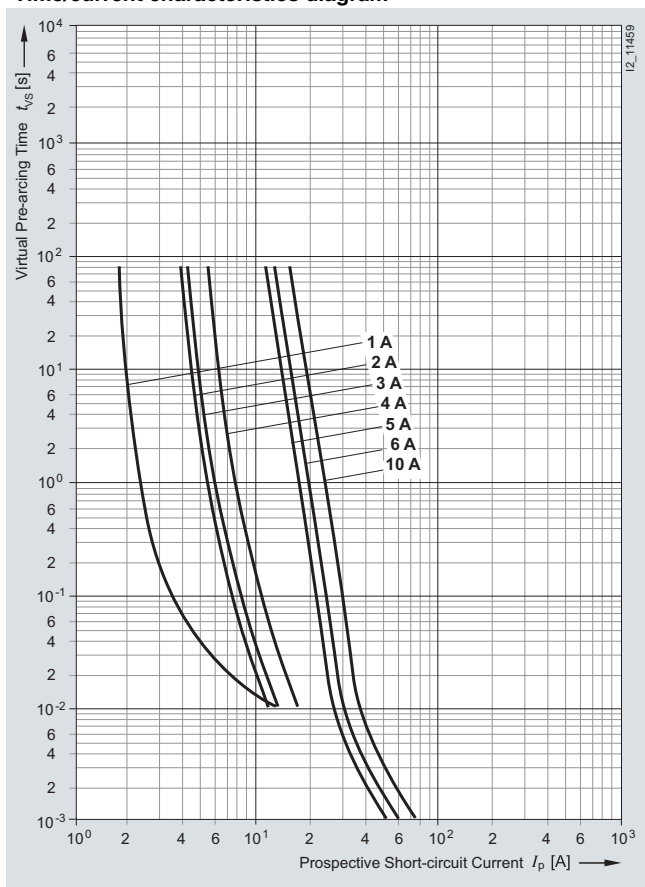

Let-through characteristics (current limitation at 50 Hz)

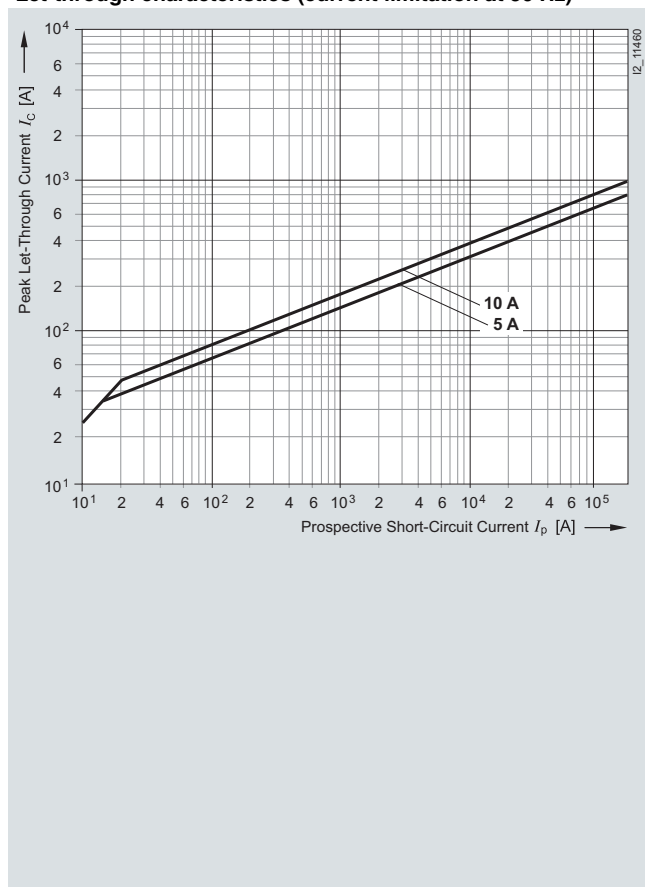

Correction factor k_A for breaking I^2t value

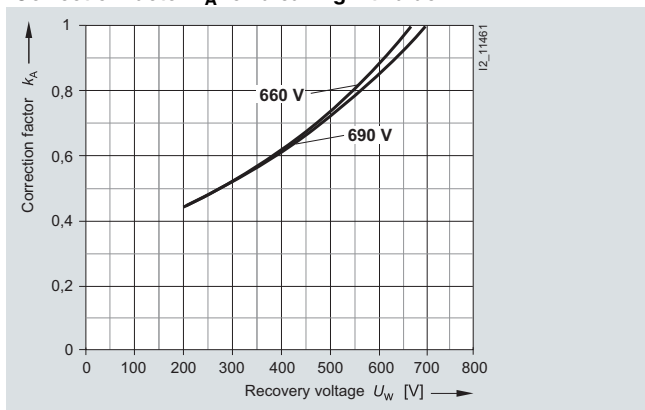

Peak arc voltage

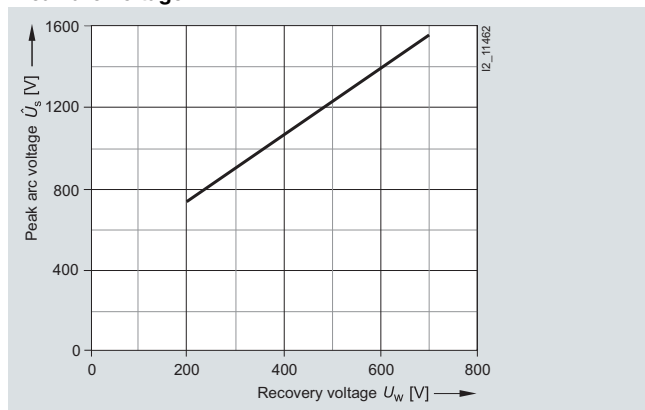

Fuse systems

SITOR semiconductor fuses

Cylindrical fuse design, 3NC1, 3NC2

Series 3NC1 4

Size: 14 mm × 51 mm
 Operational class: aR
 Rated voltage: 690 V AC/700 V DC
 Rated current: 15 ... 50 A

Time/current characteristics diagram

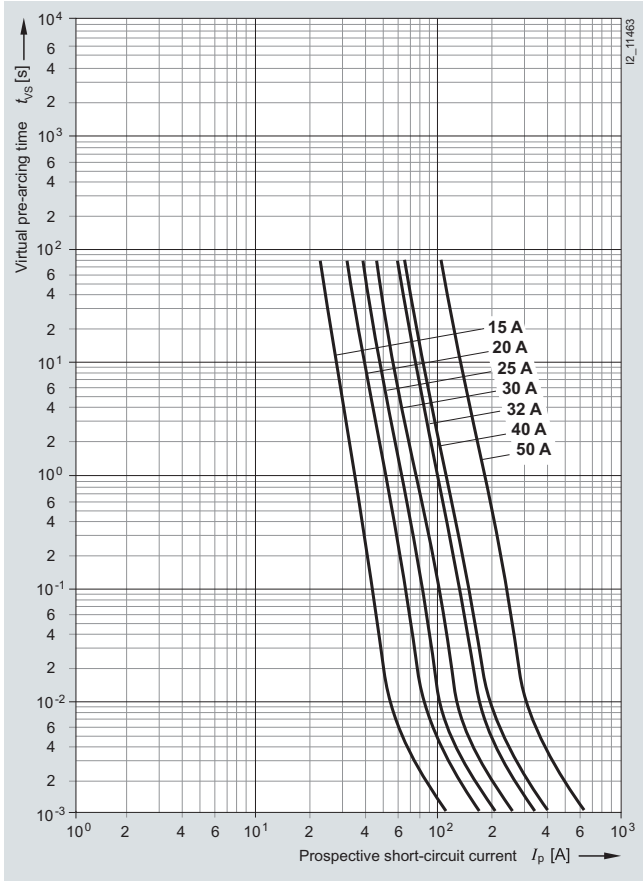

Let-through characteristics (current limitation at 50 Hz)

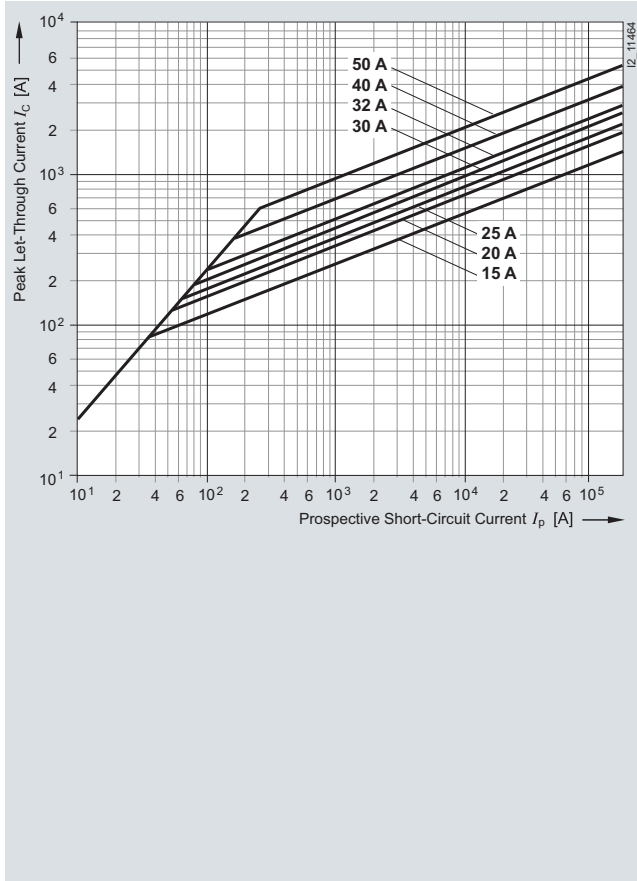

Correction factor k_A for breaking I^2t value

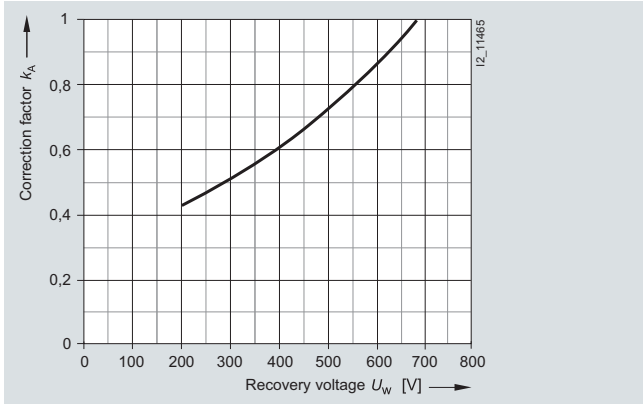

Peak arc voltage

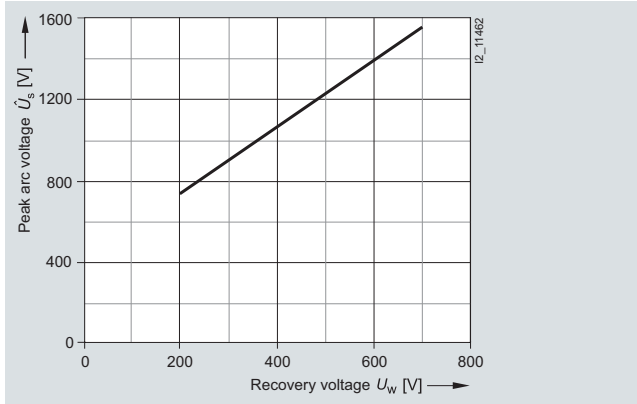

Fuse systems

SITOR semiconductor fuses

Cylindrical fuse design, 3NC1, 3NC2

Series 3NC1 4...5 with striking pin

Size: 14 mm × 51 mm
 Operational class: aR
 Rated voltage: 690 V AC/700 V DC
 Rated current: 10 ... 50 A

Time/current characteristics diagram

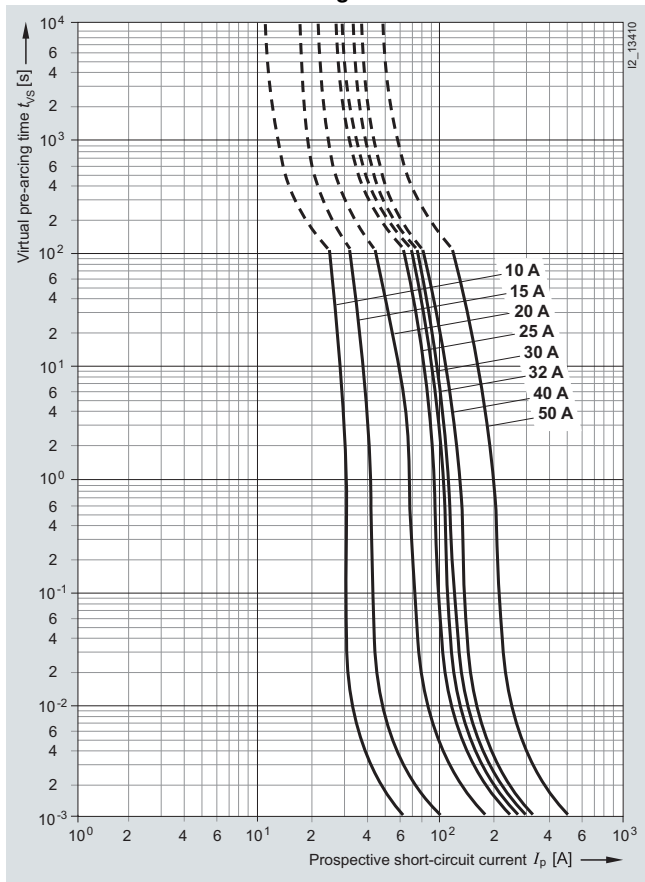

Let-through characteristics (current limitation at 50 Hz)

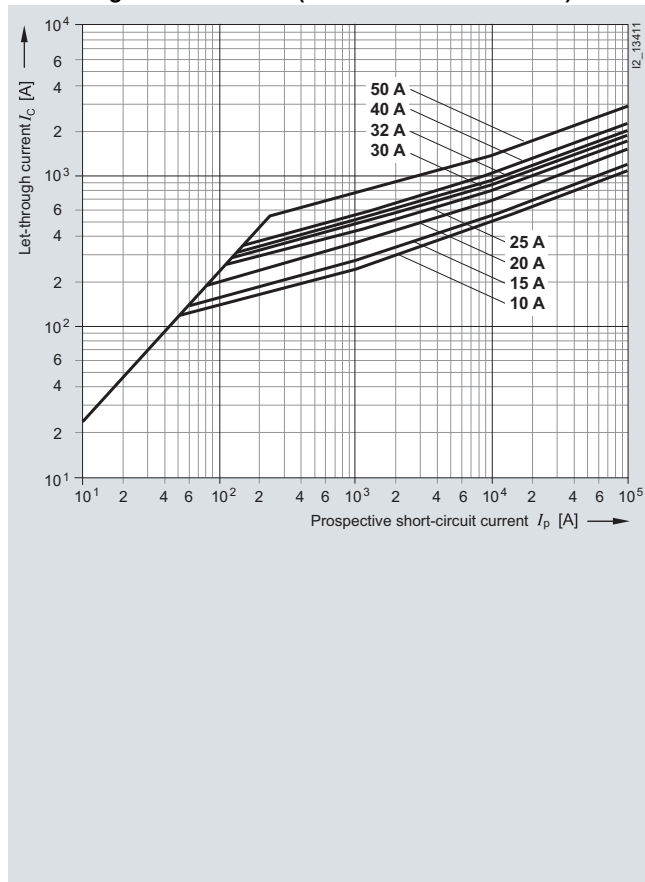

Correction factor k_A for breaking I^2t value

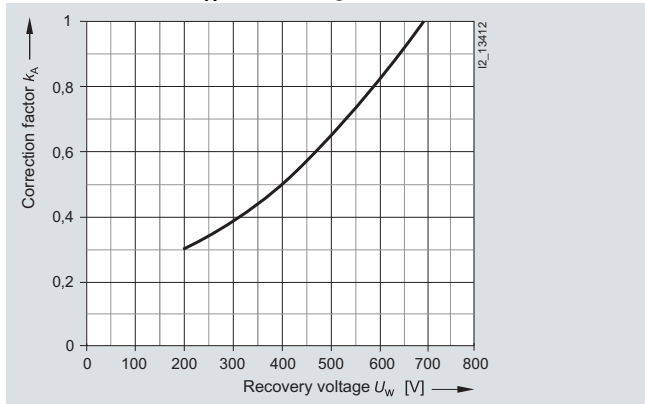

Peak arc voltage

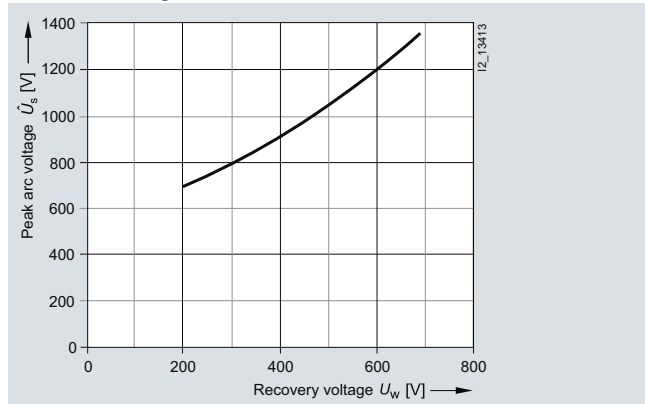

Fuse systems

SITOR semiconductor fuses

Cylindrical fuse design, 3NC1, 3NC2

Series 3NC2 2

Size: 22 mm × 58 mm
 Operational class: aR
 Rated voltage: 690 V AC/700 V DC (20 ... 80 A);
 600 V AC/700 V DC (100 A)
 Rated current: 20 ... 100 A

Time/current characteristics diagram

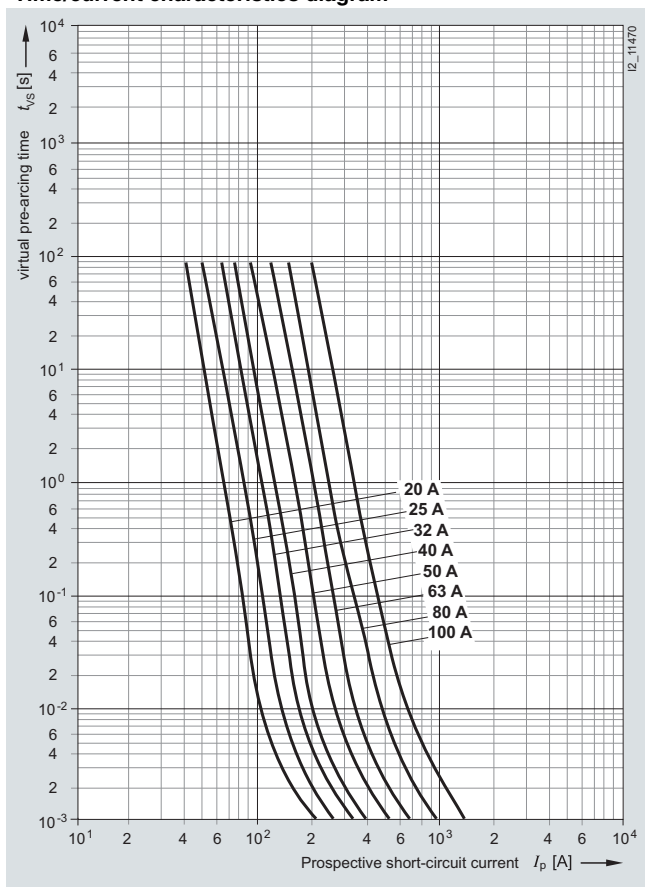

Let-through characteristics (current limitation at 50 Hz)

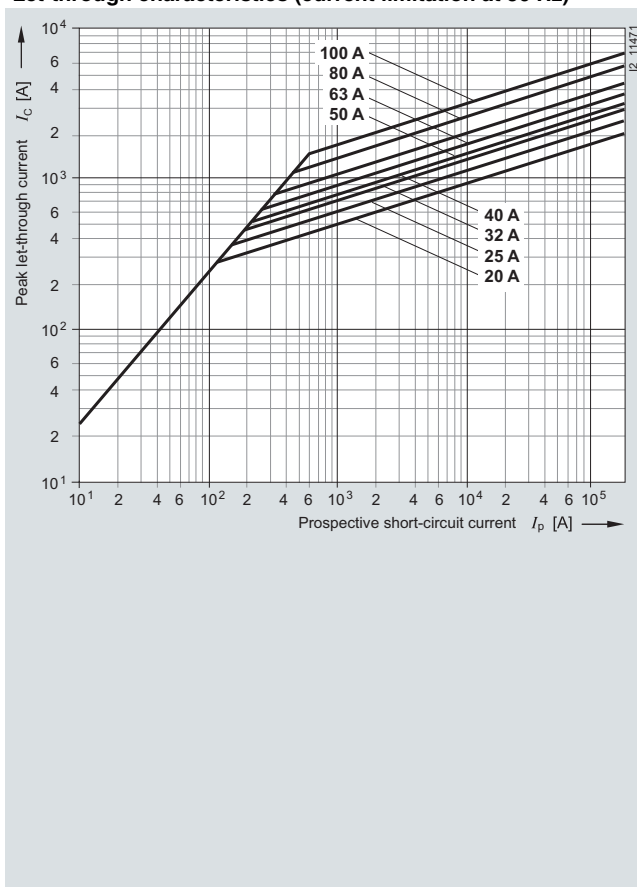

Correction factor k_A for breaking I^2t value

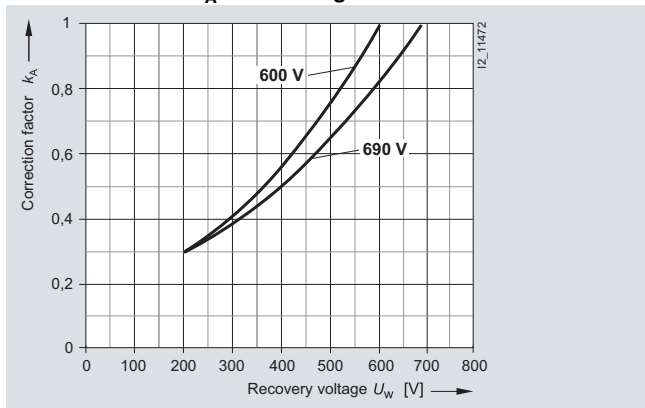

Peak arc voltage

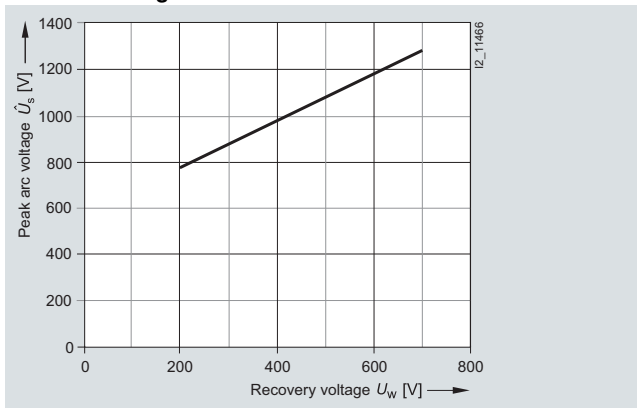

Fuse systems

SITOR semiconductor fuses

Cylindrical fuse design, 3NC1, 3NC2

Series 3NC2 2...-5 with striking pin

Size: 22 mm × 58 mm
 Operational class: aR
 Rated voltage: 690 V AC/700 V DC (20 ... 80 A);
 600 V AC/700 V DC (100 A)
 Rated current: 20 ... 100 A

Time/current characteristics diagram

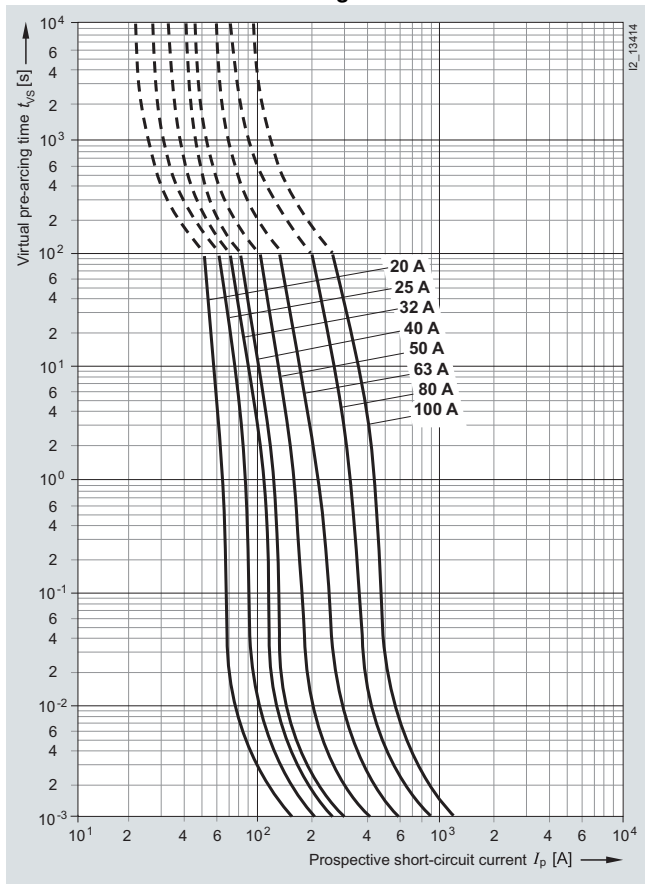

Let-through characteristics (current limitation at 50 Hz)

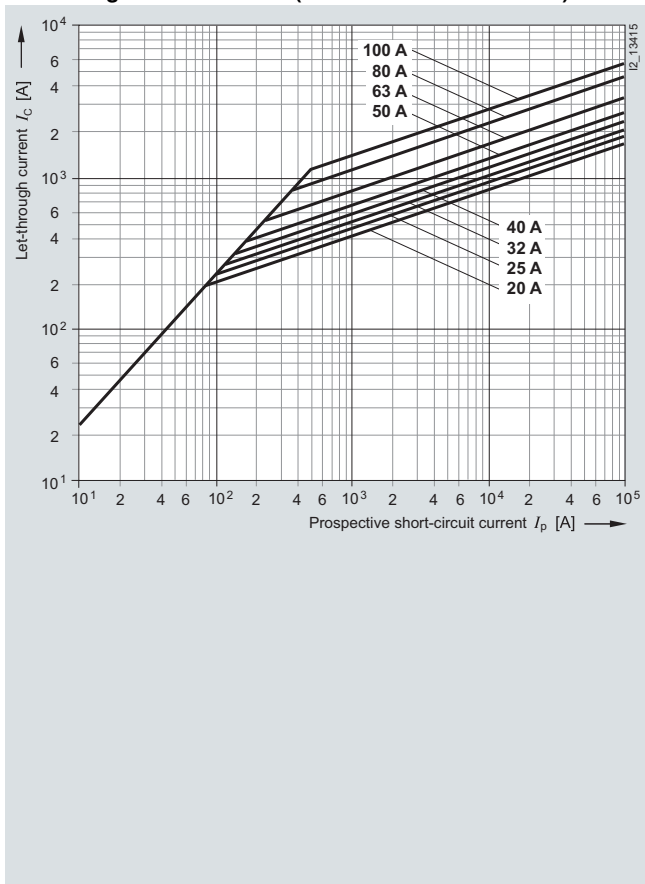

Correction factor k_A for breaking I^2t value

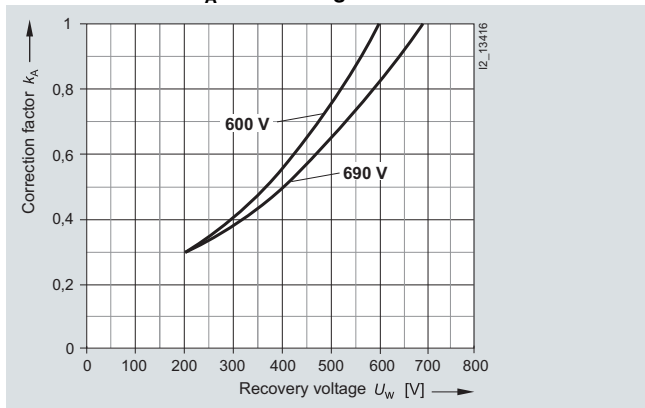

Peak arc voltage

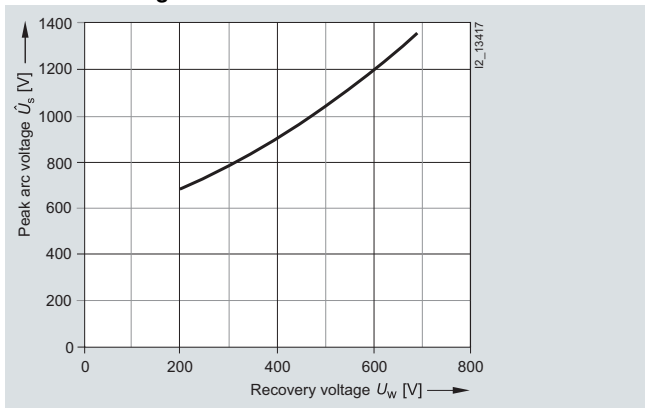

Fuse systems

SITOR semiconductor fuses

NEOZED and DIAZED design, SILIZED,
3SE1, 5SD4

Overview

SILIZED is the brand name of the NEOZED fuses (D0 fuses) and the DIAZED fuses (D fuses) with super quick characteristic for semiconductor protection. The fuses are used in combination with fuse bases, fuse screw caps and accessory parts of the standard fuse system.

SILIZED fuses protect power semiconductors from the effects of short circuits because the super quick disconnect characteristic is far quicker than that of conventional fuses. They protect expensive devices and system components, such as semiconductor contactors, static relays, converters with fuses in the input and in the DC link, UPS systems and soft starters for motors up to 100 A.

When using fuse bases and fuse screw caps made of molded plastic, always heed the maximum permissible power loss values due to the high power loss (power dissipation) of the SILIZED fuses. When using these components, the following maximum permissible power loss applies:

- NEOZED D02: 5.5 W
- DIAZED DII: 4.5 W
- DIAZED DIII: 7.0 W

For this reason, sometimes a thermal permanent load of only 50 % is possible.

The DIAZED screw adapter DII for 25 A is used for the 30 A fuse link.

Technical specifications

	SILIZED fuse links, NEOZED design 5SE1 3	SILIZED fuse links, DIAZED design 5SD4
Standards	DIN VDE 0636-3; IEC 60269-3; DIN VDE 0636-4; IEC 60269-4	
Operational class	gR	
Characteristic	Super quick	
Rated voltage U_n	V AC 400 V DC 250	500 500
Rated current I_n	A 10 ... 63	16 ... 100
Rated breaking capacity	kA AC 50 kA DC 8	
Mounting position	Any, but preferably vertical	
Non-interchangeability	Using adapter sleeves	Using screw adapter or adapter sleeves
Resistance to climate	°C up to 45 at 95 % rel. humidity	
Ambient temperature	°C -5 ... +40, humidity 90 % at 20	

Dimensional drawings

5SE1

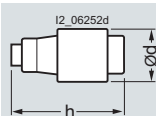

5SD4 20, 5SD4 30, 5SD4 40, 5SD4 80

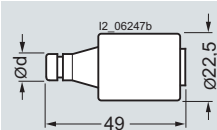

5SD4 50, 5SD4 60, 5SD4 70

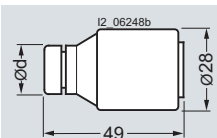

5SD5 10, 5SD5 20

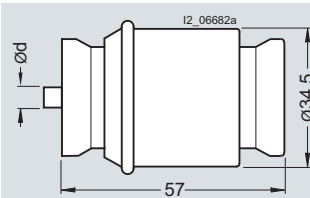

Size	D01	D02
Rated current in A	10 ... 16	20 ... 63
Dimension d	11	15.3
Dimension h	36	36

Size/thread	DII/E27			
Rated current in A	16	20	25	30
Dimension d	10	12	14	14

Size/thread	DIII/E33		
Rated current in A	35	50	63
Dimension d	16	18	20

Size/thread	DIV/R1¼"	
Rated current in A	80	100
Dimension d	5	7

Fuse systems

SITOR semiconductor fuses

SILIZED, NEOZED and DIAZED design

Technical specifications

Type	Sizes	NEOZED design						
		I_n	P_v	$\Delta\theta$	I^2t_s	I^2t_a	230 V AC	400 V AC
		A	W	K	1 ms A ² s	4 ms A ² s		
5SE1 310	D01	10	6.9	64	30	30	56	73
5SE1 316		16	6.2	61	31	34	92	120
5SE1 320	D02	20	8.1	64	50	56	146	190
5SE1 325		25	8.2	63	120	120	166	215
5SE1 335		35	16.7	100	145	182	361	470
5SE1 350		50	12.0	80	460	540	1510	1960
5SE1 363		63	15.5	96	845	932	3250	4230

Type	Sizes	DIAZED design				
		I_n	P_v	$\Delta\theta$	I^2t_s	I^2t_a
		A	W	K	1 ms A ² s	500 V AC A ² s
5SD4 20	DII	16	12.1	63	16.2	60
5SD4 30		20	12.3	69	35.8	139
5SD4 40		25	12.5	61	48.9	205
5SD4 80		30	13.4	65	85	310
5SD4 50	DIII	35	14.8	62	135	539
5SD4 60		50	18.5	66	340	1250
5SD4 70		63	28	84	530	1890
5SD5 10	DIV	80	34.3	77	980	4200
5SD5 20		100	41.5	83	1950	8450

Characteristic curves

Series 5SE1 3..

Sizes: D01, D02
 Operational class: gR
 Rated voltage: 400 V AC/250 V DC
 Rated current: 10 ... 63 A

Time/current characteristics diagram

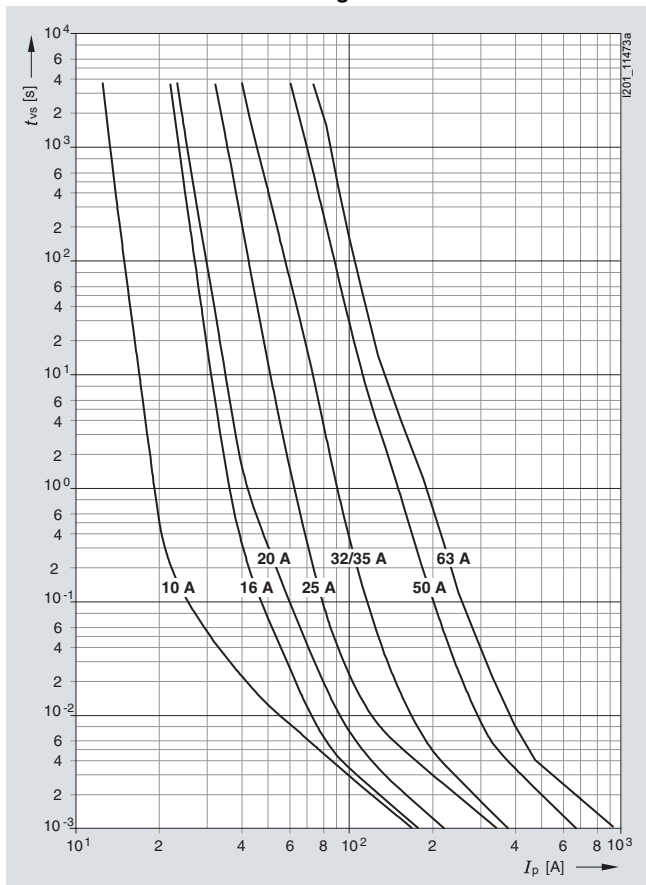

Melting I^2t values diagram

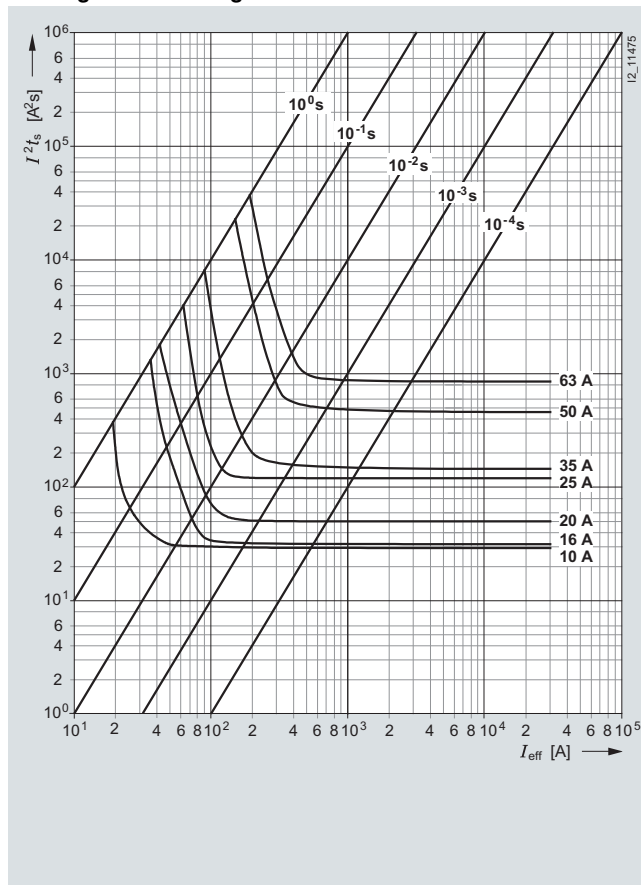

Current limitation diagram

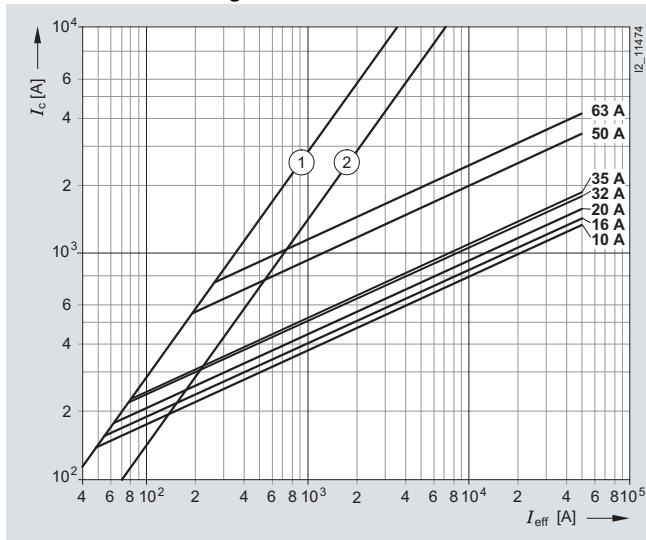

- ① Peak short-circuit current with largest DC component
- ② Peak short-circuit current without DC component

Fuse systems

SITOR semiconductor fuses

SILIZED, NEOZED and DIAZED design

Series 5SD4, 5SD5

Size: DII, DIII, DIV
 Operational class: gR
 Characteristic: super quick
 Rated voltage: 500 V AC/500 V DC
 Rated current: 16 ... 100 A

Time/current characteristics diagram

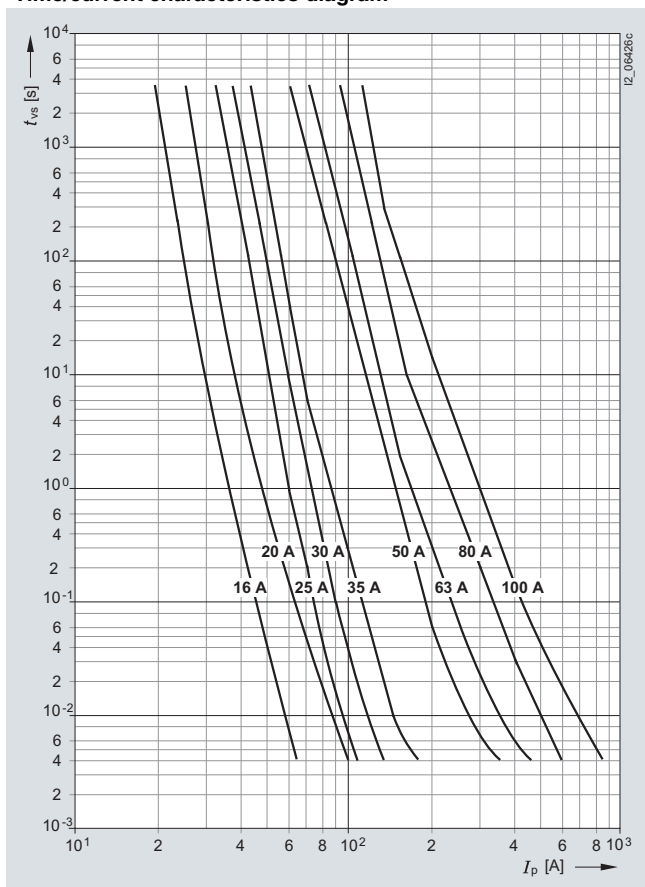

Melting I^2t values diagram

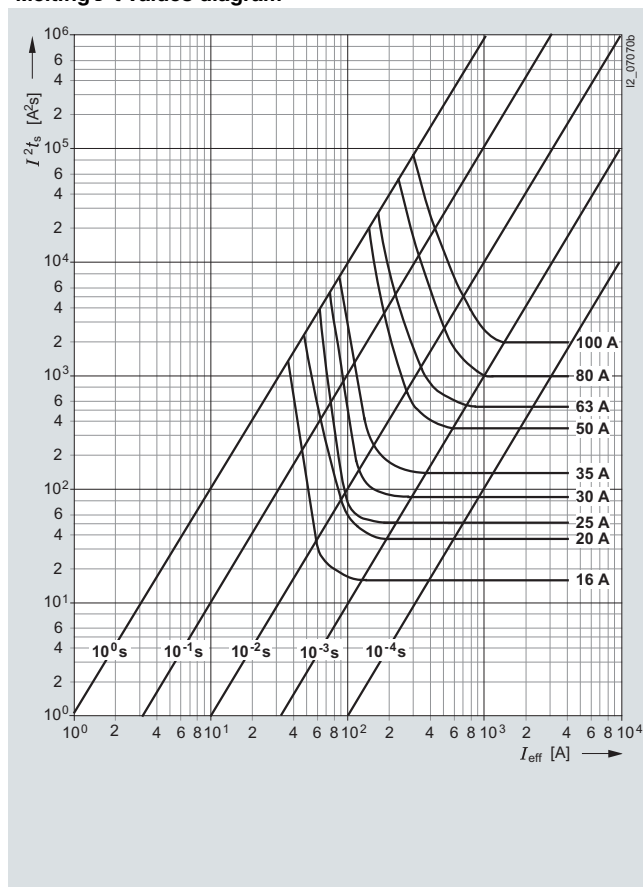

Current limitation diagram

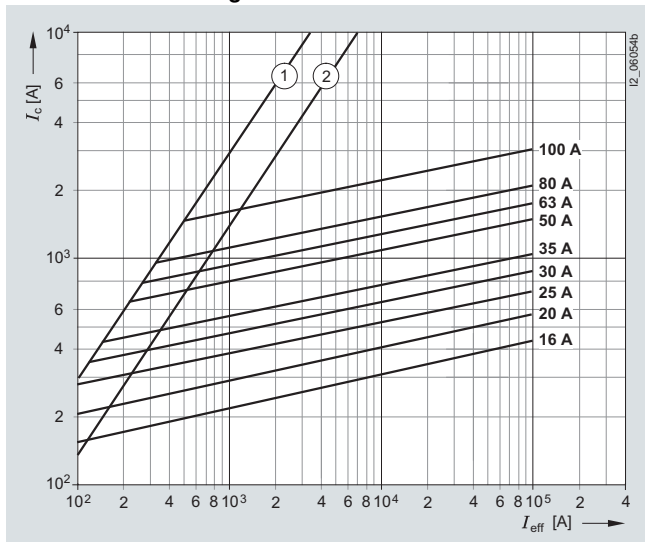

- ① Peak short-circuit current with largest DC component
- ② Peak short-circuit current without DC component

Overview

Parameters

The fuse links are selected according to rated voltage, rated current, breaking I^2t value I^2t_b , and varying load factor, taking into consideration other specified conditions. All of the following data refer, unless otherwise specified, to the use of alternating current from 45 Hz to 62 Hz.

Rated voltage U_n

The rated voltage of a SITOR fuse link is the voltage specified as the r.m.s. value of the AC voltage on the fuse link and in the order and configuration data and the characteristics.

Always ensure that the rated voltage of the fuse link you select is such that the fuse link will reliably quench the voltage driving the short-circuit current. The driving voltage must not exceed the value $U_n + 10\%$. Please note that the supply voltage U_{V0} of a power converter can also be increased by 10%. If, in the shorted circuit, two arms of a converter connection are connected in series, and if the short-circuit current is sufficiently high, it can be assumed that voltage sharing is uniform. It is essential to observe the instructions in "Series connection of fuse links" on page 146.

Rectifier operation

With converter equipment that can only be used for rectifier operation, the supply voltage U_{V0} is the driving voltage.

Inverter operation

With converter equipment that can also be used for inverter operation, shoot-throughs may occur as faults. In this case, the driving voltage U_{WK} in the shorted circuit is the sum of the infeed direct voltage (e.g. the e.m.f. of the DC generator) and the AC-line supply voltage. When rating a fuse link, this sum can be replaced by an AC voltage whose r.m.s. value is 1.8 times that of the AC-line supply voltage ($U_{WK} = 1.8 U_{V0}$). The fuse links must be rated so that they reliably quench the voltage U_{WK} .

Rated current I_n , load rating

The rated current of a SITOR fuse link is the current specified in the selection and ordering data, in the characteristic curves and on the fuse link current as the r.m.s. value of an alternating current for the frequency range 45 Hz and 62 Hz.

When operating fuse links with rated current, the following are considered normal operating conditions:

- Natural air cooling with an ambient temperature of +45 °C
- Conductor cross-sections equal test cross-sections (see Test cross-sections table), for operation in LV HRC fuse bases and switch-disconnectors, please refer to the Selection and ordering data
- Conduction angle of a half-period 120°el
- Continuous load maximum with rated current.

For operating conditions that deviate from the above, the permissible load current I_n' of the SITOR fuse link can be determined using the following formula:

$$I_n' = k_U \times k_Q \times k_\lambda \times k_f \times WL \times I_n$$

whereby

I_n Rated current of the fuse link¹⁾

k_U Correction factor for ambient temperature (page 140)

k_Q Correction factor for conductor cross-section (page 140)

k_λ Correction factor for conduction angle (page 140)

k_f Correction factor for forced-air cooling (page 140)

WL Varying load factor (page 141)

Test cross-sections

Rated current I_n	Test cross-sections	
	(series 3NC1 0, 3NC1 1, 3NC1 4, 3NC1 5, 3NC2 2, 3NE1 ..., 3NE8 0..., 3NE4) ¹⁾	(all other series)
A	Cu mm ²	Cu mm ²
10	1.0	--
16	1.5	--
20	2.5	45
25	4	45
35	6	45
40	10	45
50	10	45
63	16	45
80	25	45
100	35	60
125	50	80
160	70	100
200	95	125
224	--	150
250	120	185
315	2 × 70	240
350	2 × 95	260
400	2 × 95	320
450	2 × 120	320
500	2 × 120	400
560	2 × 150	400
630	2 × 185	480
710	2 × (40 × 5)	560
800	2 × (50 × 5)	560
900	2 × (80 × 4)	720
1000	--	720
1100	--	880
1250	--	960
1400	--	1080
1600	--	1200

¹⁾ When using SITOR fuse links in LV HRC fuse bases according to IEC/EN 60269-2-1 and fuse switch disconnectors and switch disconnectors with fuses, please also refer to the data in the selection and ordering data.

Fuse systems

SITOR semiconductor fuses

Configuration

Correction factor for ambient temperature k_u

The influence of the ambient temperature on the permissible load of the SITOR fuse links is taken into account using the correction factor k_u as shown in the following graph.

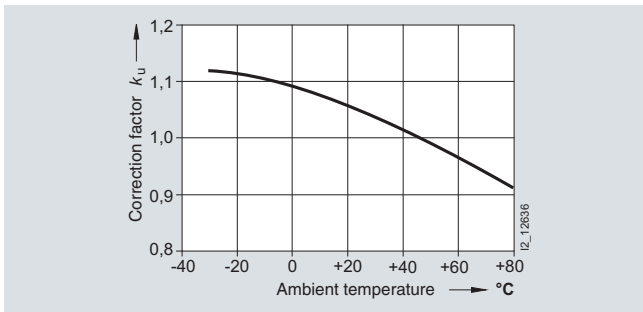

Correction factor for conductor cross-section k_q

The rated current of the SITOR fuse links applies to operation with conductor cross-sections that correspond to the respective test cross-section (see the table on page 139).

In the case of reduced conductor cross-sections, the correction factor k_q must be used as shown in the following graph.

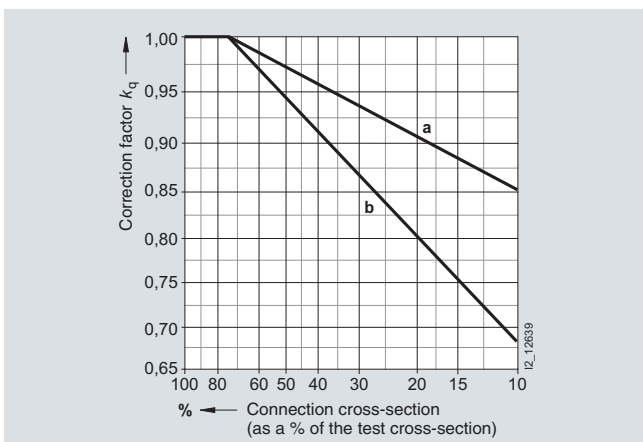

- a = Reduction of cross-section of one connection
- b = Reduction of cross-section of both connections

Correction factor for conduction angle k_λ

The rated current of the SITOR fuse links is based on a sinusoidal alternating current (45 Hz and 62 Hz). However, in converter operation, the arm fuses are loaded with an intermittent current, whereby the conduction angle is generally 180°el or 120°el. With this load current wave form, the fuse link can still carry the full rated current. In the case of smaller conduction angles, the current must be reduced in accordance with the following graph.

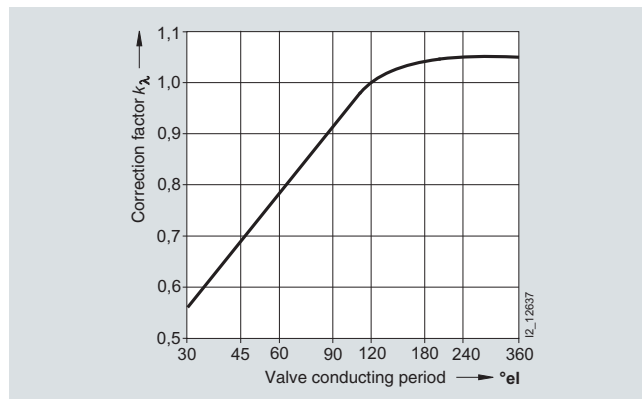

Correction factor for forced-air cooling k_l

In the case of increased air cooling, the current carrying capacity of the fuse link increases with the air speed, air speeds > 5 m/s do not effect any significant further increase of current carrying capacity.

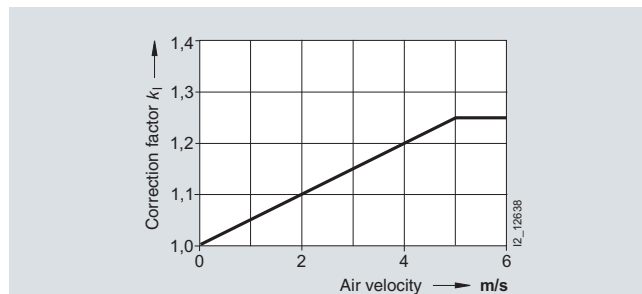

Varying load factor WL

The varying load factor WL is a reduction factor by which the non-aging current carrying capacity of the fuse links can be determined for any load cycles. Due to their design, the SITOR fuse links have different varying load factors. In the characteristic curves of the fuse links, the respective varying load factor WL for > 10000 load changes (1 hour "ON", 1 hour "OFF") is specified for the expected operating time of the fuse links. In the event of a lower number of load changes during the expected operating

time, it may be possible to use a fuse link with a smaller varying load factor WL as shown in the following graph.

In the case of uniform loads (no load cycles and no shutdowns), the varying load factor can be taken as $WL = 1$. For load cycles and shutdowns that last longer than 5 min. and are more frequent than once a week, you need to select the varying load factor WL specified in the characteristic curves of the individual fuse links.

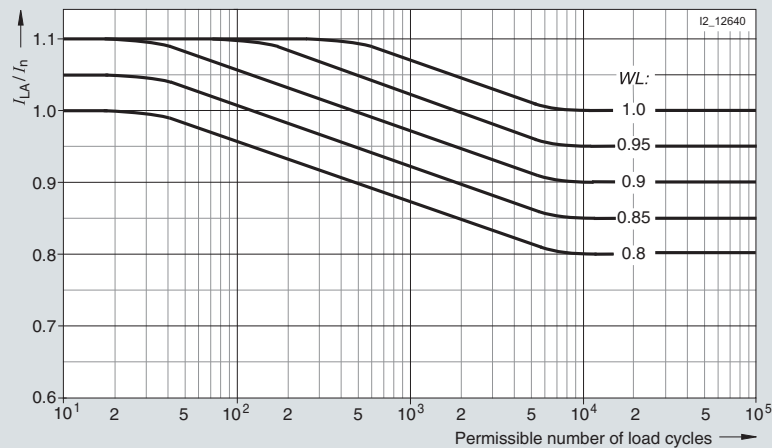

Waveform of the varying load factor WL for load cycles

Fuse currents for operation in power converter

The r.m.s. value of the fuse current can be calculated for the most common converter connections from the (smoothed) direct current I_d or the conductor current I_L according to the following table.

Converter connection		R.m.s. value of the conductor current (phase fuse)	R.m.s. value of the branch-circuit current (arm fuse)
One-pulse center tap connection	(M1)	$1.57 I_d$	--
Double-pulse center tap connection	(M2)	$0.71 I_d$	--
Three-pulse center tap connection	(M3)	$0.58 I_d$	--
Six-pulse center tap connection	(M6)	$0.41 I_d$	--
Double three-pulse center tap connection (parallel)	(M3.2)	$0.29 I_d$	--
Two-pulse bridge circuit	(B2)	$1.0 I_d$	$0.71 I_d$
Six-pulse bridge circuit	(B6)	$0.82 I_d$	$0.58 I_d$
Single-phase bidirectional connection	(W1)	$1.0 I_L$	$0.71 I_L$

Fuse systems

SITOR semiconductor fuses

Configuration

I^2t values

In the event of a short circuit, the current of the fuse link increases during melting time t_s up to let-through current I_c (melting current peak).

During the arc quenching time t_L , the electric arc develops and the short-circuit current is quenched (see the following graph).

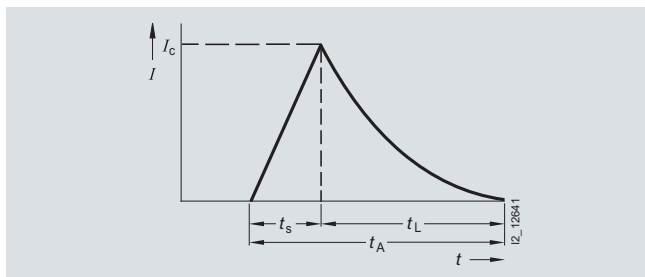

Current path when switching fuse links

The integral of the current squared ($\int I^2 dt$) over the entire operating time ($t_s + t_L$), known as the breaking I^2t value, determines the heat to be fed to the semiconductor device that is to be protected during the breaking procedure.

In order to ensure sufficient protection, the breaking I^2t value of the fuse link must be smaller than the I^2t value of the semiconductor device. As the temperature increases, i.e. preloading increases, the breaking I^2t value of the fuse link decreases almost in the same way as the I^2t value of a semiconductor device, so that it is enough to compare the I^2t values in a non-loaded (cold) state.

The breaking I^2t value (I^2t_b) is the sum of the melting I^2t value (I^2t_s) and the quenching I^2t value (I^2t_L).

$$\left(\int I^2 dt \right) (\text{semiconductor, } t_{vj} = 25^\circ\text{C, } t_p = 10 \text{ ms}) > \left(\int I^2 dt \right) (\text{fuse link})$$

Melting I^2t value I^2t_s

The melting value I^2t can be calculated for the value pairs of the time/current characteristic curve of the fuse link for any periods.

As the melting time decreases, the melting value I^2t tends towards a lower limit value at which almost no heat is dissipated from the bottleneck of the fuse element to the environment during the melting process. The melting I^2t values specified in the selection and ordering data and in the characteristic curves correspond to the melting time $t_{vs} = 1 \text{ ms}$.

Quenching I^2t value I^2t_L

While the melting I^2t value is a characteristic of the fuse link, the quenching I^2t value depends on circuit data, such as

- The recovery voltage U_w
- The power factor p.f. ϕ of the shorted circuit
- The prospective current I_p (current at the installation site of the fuse link if this is bridged)

The maximum quenching I^2t value is reached at a current of $10 \times I_n$ to $30 \times I_n$ depending on the fuse type.

Breaking I^2t value I^2t_a , correction factor k_A

The breaking I^2t values of the fuse link are specified in the characteristic curves for the rated voltage U_n . In order to determine the breaking I^2t value for recovery voltage U_w the correction factor k_A must be taken into account.

$$I^2t_a (\text{at } U_w) = I^2t_a (\text{at } U_n) \times k_A$$

The characteristics "correction factor k_A " (see the following graph) is specified in the characteristic curves for the individual fuse range. The thus determined breaking I^2t values apply to prospective currents $I_p \geq 10 \times I_n$ and p.f. = 0.35.

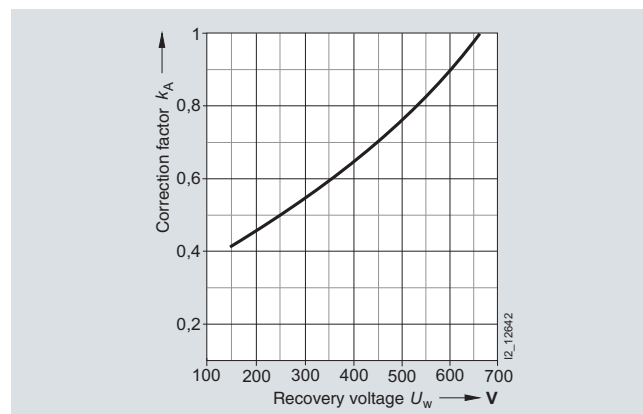

Correction factor k_A for breaking I^2t value
Example: Series 3NE8 0..

Taking into account the recovery voltage U_w

The recovery voltage U_w is derived from the voltage driving the short-circuit current. For most faults, the driving voltage is equal to the supply voltage U_{V0} , however, for shoot-throughs it is 1.8 times the value for the supply voltage U_{V0} (see rated voltage, page 139). If the shorted circuit contains two arms of a converter connection and thus two fuse links in series, and if the short-circuit current is sufficiently high (see series connection, page 146) it can be assumed that there is a uniform voltage sharing, i.e. $U_w = 0.5 \times U_{V0}$ or, in the case of shoot-throughs $U_w = 0.9 \times U_{V0}$.

Influence of the power factor p.f.

The specifications in the characteristic curves for the breaking I^2t values (I^2t_a) refer to p.f. = 0.35 (exception: for 3NC5 8..., 3NE6 4..., 3NE9 4... SITOR fuse links the following applies: p.f. = 0.2).

The dependence of the breaking I^2t values on the power factor p.f. at $1.0 \times U_n$ and at $0.5 \times U_n$ is shown in the following graphic.

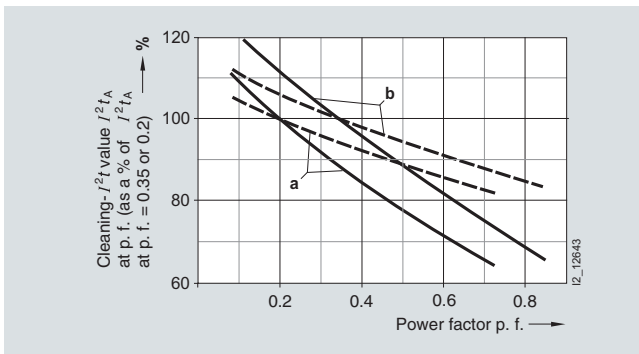

Breaking I^2t value I^2t_a of SITOR fuse links dependent on the power factor p.f.

- at $1.0 U_n$
- - - at $0.5 U_n$

a = for 3NC5 8..., 3NE6 4..., 3NE9 4... SITOR fuse links (reference to p.f. = 0.2)

b = for all other SITOR fuse links (reference to p.f. = 0.35)

Fuse systems

SITOR semiconductor fuses

Configuration

Time/current characteristics

The solid time/current characteristic curves in the following graph specify the time to melting for the non-loaded fuse link in a cold state (max. +45 °C).

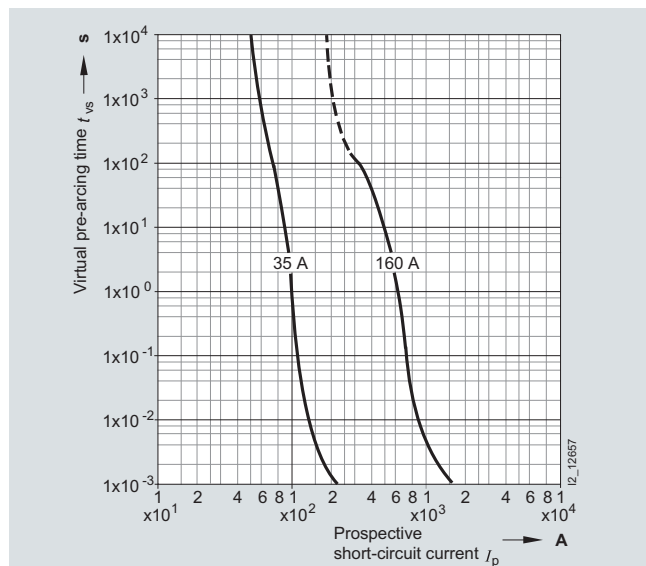

35 A: Operational class gR
160 A: Operational class aR

If the time/current characteristic curve in the long-time range ($t_{vs} > 30$ s) is dashed (fuse links of aR operational class), this specifies the limit of the permissible overload in a cold state. If the dotted part of the characteristic curve is exceeded, there is a risk of damage to the ceramic body of the fuse link. The fuse links can only be used for short-circuit protection. In this case, an additional protective device (overload relay, circuit breaker) is required to protect against overload. In the case of controlled converter equipment, the current limiter is sufficient.

If the time/current characteristic curve is shown as a solid line over the entire setting range (fuse links of operational class gR or gS), the fuse link can operate in this range. This means it can be used both for overload and short-circuit protection.

Actual melting time

The virtual melting time t_{vs} is specified in the time/current characteristic curve, depending on the prospective current. It is a value that applies to the current squared ($di/dt = \infty$).

In the case of melting times $t_{vs} < 20$ ms the virtual melting time t_{vs} deviates from the actual melting time t_s . The actual melting time may be several milliseconds longer (depending on the rate of current rise).

Within a range of several milliseconds, during which the rise of the short-circuit current can be assumed to be linear, the actual melting time for a sinusoidal current rise and 50 Hz is as follows:

$$t_s = \frac{3xI^2 t_s}{I_c^2}$$

Taking into account preloading, residual value factor RW

Preloading the fuse link shortens the permissible overload duration and the melting time.

The residual value factor RW can be used to determine the time that a fuse link can be operated during a periodic or non-periodic load cycle, above and beyond the previously determined permissible load current I_n , with any overload current I_{La} without aging.

The residual value factor RW is dependent on the preloading V (I_{eff} , r.m.s. value of the fuse current during the load cycle at permissible load current I_n)

$$V = \frac{I_{eff}}{I_n'}$$

and the frequency of the overloads (see the following graph, curves a and b).

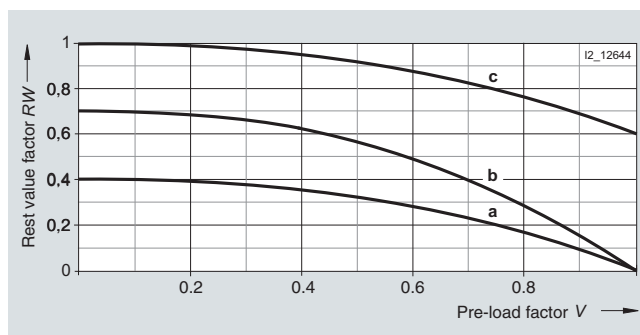

Permissible overload and melting time for previous load

- a = frequent surge/load cycle currents (>1/week)
- b = infrequent surge/load cycle currents (<1/week)
- c = melting time for preloading

Permissible overload duration = residual value factor RW × melting time t_{vs} (time/current characteristic curve)

A reduction of the melting time of a fuse link in the case of preloading can be derived from curve c.

Melting time = residual value factor RW × melting time t_{vs} (time/current characteristic curve)

Let-through current I_c

The let-through current I_c can be determined from the current limiting characteristics (current limitation at 50 Hz) specified for the respective fuse link. This depends on the prospective current and the DC component when the short circuit occurs (instant of closing).

The following graph shows the let-through current I_c of a fuse link, depending on the prospective short-circuit current I_p using the 3NE4 333-0B SITOR fuse link as an example.

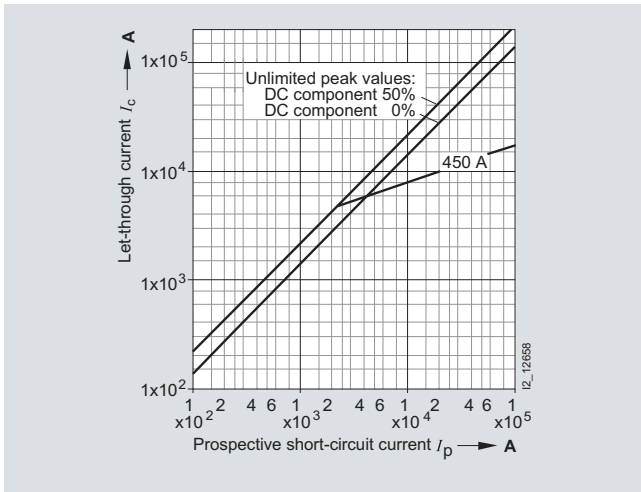

Example:
3NE4 333-0B SITOR fuse link

Rated breaking capacity

The rated breaking capacity of all SITOR fuse links is at least 50 kA, unless higher values are specified in the characteristic curves.

The data apply to a test voltage of $1.1 \times U_n$, 45 Hz to 62 Hz and $0.1 \leq \text{p.f.} \leq 0.2$. In the case of inception voltages that are below the rated voltage as well as rated currents of the fuse links that are below the maximum rated current of a fuse range, the breaking capacity is considerably higher than the rated breaking capacity.

Peak arc voltage \hat{U}_s

During the quenching process, a peak arc voltage \hat{U}_s occurs at the connections of the fuse link, which can significantly exceed the supply voltage. The level of the peak arc voltage depends on the design of the fuse link and the level of the recovery voltage. It is presented in characteristic curves as a function of the recovery voltage U_w (see the following graph).

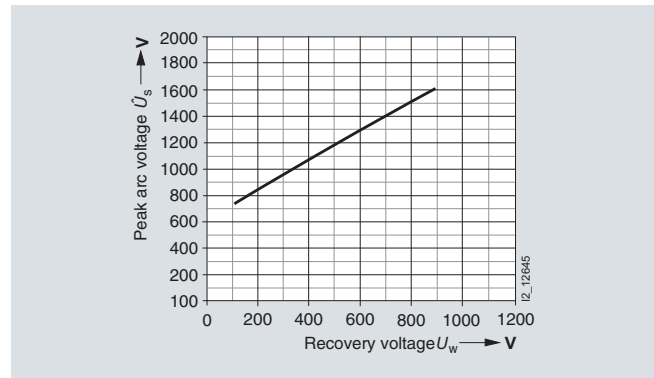

Example:
3NE4 333-0B SITOR fuse link

The peak arc voltage occurs as a cutoff voltage at the semiconductor devices not in the shorted circuit. In order to prevent voltage-related hazards, the peak arc voltage must not exceed the peak cutoff voltage of the semiconductor devices.

Power dissipation, temperature rise

On reaching the rated current, the fuse elements of the SITOR fuse links have a considerably higher temperature than the fuse elements of line protection fuse links.

The power dissipation specified in the characteristic curve is the upper variance coefficient if the fuse link is loaded with the rated current.

In the case of partial loads, this power dissipation decreases as shown in the following graph

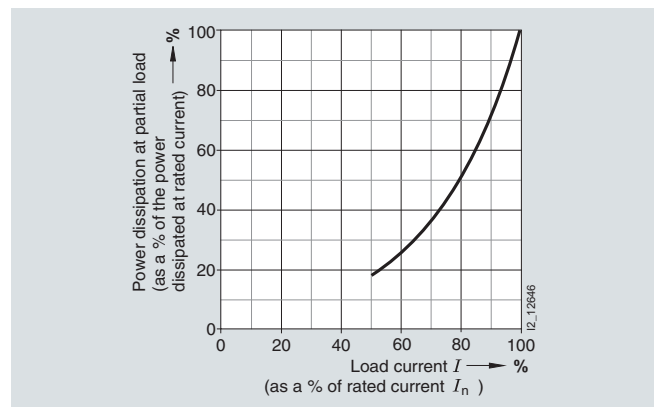

The temperature rise specified in the characteristic curve applies to the respective reference point and is determined when testing the fuse link (test setup according to DIN VDE 0636, Part 23 and IEC 269-4).

Fuse systems

SITOR semiconductor fuses

Configuration

Parallel and series connection of fuse links

Parallel connection

If an arm of a converter connection has several semiconductor devices so that the fuse links are connected in parallel, only the fuse link connected in series to the faulty semiconductor device is tripped in the event of an internal short circuit. It must quench the full supply voltage.

To boost the voltage, two or more parallel fuse links can be assigned to a single semiconductor device without reducing the current. The resulting breaking I^2t value increases with the square of the number of parallel connections. In this case, in order to prevent incorrect distribution of the current, you should only use fuse links of the same type.

Series connection

There are two kinds of series connection available:

- Series connection in the converter arm
- Two fused converter arms through which a short-circuit current flows in series

In both cases, uniform voltage sharing can only be assumed if the melting time of the SITOR fuse link does not exceed the value specified in the following table.

SITOR fuse links	Maximum melting time for uniform voltage sharing
Type	ms
3NC1 0..	10
3NC1 4..	
3NC1 5..	
3NC2 2..	
3NC2 4..	40
3NC5 8..	
3NC7 3..	
3NC8 4..	
3NE1 0..	10
3NE1 2..	
3NE1 3..	
3NE1 4..	20
3NE1 8..	
3NE3 2..	10
3NE3 3..	
3NE3 4..	
3NE3 5..	20
3NE3 6..	
3NE4 1..	10
3NE4 3..	
3NE5 4..	20
3NE5 6..	
3NE6 4..	10
3NE7 4..	
3NE7 6..	20
3NE8 0..	
3NE8 7..	
3NE9 4..	10
3NE9 6..	

Cooling conditions for series-connected fuse links should be approximately the same. If faults are expected, during which the specified melting times are exceeded (as a result of a slower current rise), it can no longer be assumed that voltage sharing is uniform. The voltage of the fuse links must then be rated so that a single fuse link can quench the full supply voltage.

It is best to avoid the series connection of fuse links in a converter connection arm and instead use a single fuse link with a suitably high rated voltage.

Use with direct current

For fuse links that are to be used in DC circuits, some data may vary from the data specified in the characteristic curves for alternating current.

Permissible direct voltage

The permissible direct voltage U_{perm} of the fuse links depends on the rated voltage U_n , of the time constants $\tau=L/R$ in the DC circuit and on the prospective current I_p . The permissible direct voltage refers to the rated voltage U_n and is specified depending on the time constants τ , the prospective current is a parameter (see the following graphs).

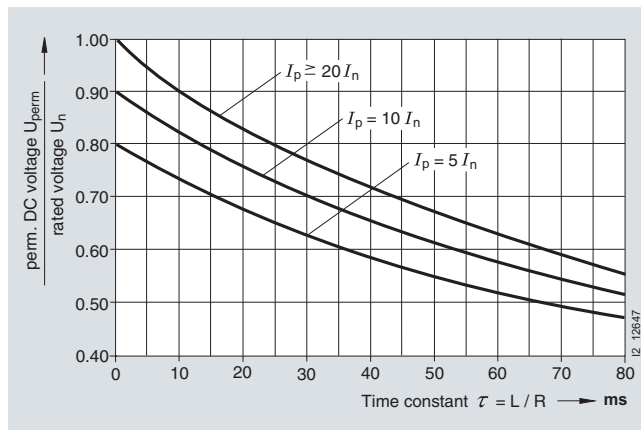

Applies to all series except 3NE1 0.., 3NE1 8..

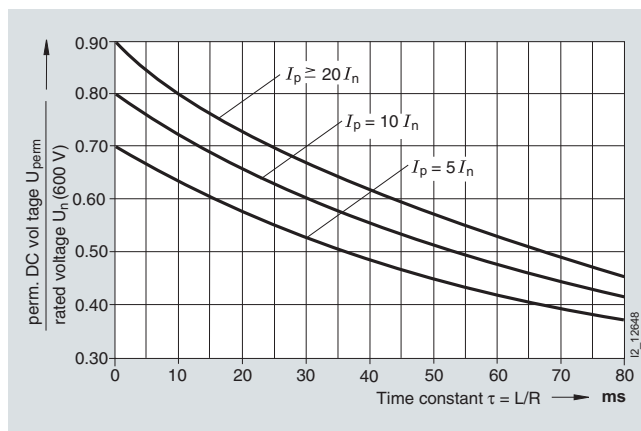

Applies to all series except 3NE1 0.., 3NE1 8..

Breaking I^2t value $I_a^2 t_a$

The breaking I^2t value $I_a^2 t_a$ depends on the voltage, on the time constants $\tau=L/R$ and on the prospective current I_p . It is calculated from the $I_a^2 t_a$ value specified in the characteristic curve for the respective fuse link at rated voltage U_n and correction factor k_A whereby, instead of the recovery voltage U_w , the direct voltage is used against which the fuse link is to switch.

The breaking I^2t value determined in this way applies under the following conditions:

- Time constant $L/R \leq 25$ ms for $I_p \geq 20 \times I_n$
- Time constant $L/R \leq 10$ ms for $I_p = 10 \times I_n$
- The breaking I^2t values increase by 20 %
- For $I_p \geq 20 \times I_n$ and time constants $L/R = 60$ ms
- For $I_p = 10 \times I_n$ and time constants $L/R = 35$ ms

Peak arc voltage \hat{U}_s

The peak arc voltage \hat{U}_s is determined from the curve specified in the characteristics for the respective fuse link, whereby instead of the recovery voltage U_w , the direct voltage is used against which the fuse link is to switch.

The peak arc voltage determined in this way applies under the following conditions:

- Time constants $L/R \leq 20$ ms for $I_p \geq 20 I_n$
- Time constants $L/R \leq 35$ ms for $I_p = 10 I_n$.

The switching voltages increase by 20 %

- For $I_p \geq 20 I_n$ and time constants $L/R = 45$ ms
- For $I_p = 10 I_n$ and time constants $L/R = 60$ ms.

Indicator

An indicator shows the switching of the fuse link. The SITOR fuse links have an indicator whose operational voltage lies between 20 V ($U_n \leq 1000$ V) and 40 V ($U_n > 1000$ V).

Accessories

Fuse bases, fuse pullers

Some of the SITOR fuse links can be inserted in matching fuse bases. The matching fuse bases (single-pole and three-pole) and the respective fuse pullers are listed in the technical specifications, from page 84.

Note

Even if the values of the rated voltage and/or current of the fuse bases are lower than that of the allocated fuse link, the values of the fuse link apply.

Fuse switch disconnectors, switch disconnectors with fuses

Some series of SITOR fuse links are suitable for operation in 3NP4 and 3NP5 fuse switch disconnectors or in 3KL and 3KM switch disconnectors with fuses (see catalogs LV 10 and LV 30).

When using switch disconnectors, the following points must be observed:

- Because, compared to LV HRC fuses, the power dissipation of the SITOR fuse links is higher, the permissible load current of the fuse links sometimes needs to be reduced, see below (Configuration manual)
- Fuse links with rated currents $I_n > 63$ A must not be used for overload protection even when they have gR operational class.

Note:

By contrast, all fuse links of the 3NE1 ... series with rated currents I_n from 16 A to 850 A and operational classes gR and gS can be used for overload protection.

- The rated voltage and rated isolation voltage of the switch disconnectors must at least correspond to the available voltage.
- When using fuse links of the 3NE3 2.., 3NE3 3.., 3NE4 3.., 3NC2 4.. and 3NC8 4.. series the switching capacity of the fuse switch disconnectors must not be fully utilized due to the slotted blade. Occasional switching of currents up to the rated current of the fuse link is permissible
- When used in fuse switch disconnectors, fuse links of the 3NE4 1.. series may only be occasionally switched, and only without load, as this places the fuse blade under great mechanical stress.

In the technical specifications, starting on page 84, the switch disconnectors are allocated to their respective individual fuse links.

Fuse systems

SITOR semiconductor fuses

Configuration

Specifying the rated current I_n for non-aging operation with varying load

Power converters are often operated not with a continuous load, but with varying loads, that can also temporarily exceed the rated current of the power converter.

The selection process for non-aging operation of SITOR fuse links for four typical types of load is as follows:¹⁾

- Continuous load
- Unknown varying load, but with known maximum current
- Varying load with known load cycle
- Occasional surge load from preloading with unknown surge outcome

The diagrams for the correction factors k_u , k_q , k_λ , k_l , page 140, and the residual value factor RW , page 144, must be observed. The varying load factor WL for the fuse links is specified on page 141.

Specifying the required rated current I_n of the fuse link is carried out in two steps:

1. Specifying the rated current I_n on the basis of the r.m.s. value I_{eff} of the load current:

$$I_n > I_{\text{eff}} \times \frac{1}{k_u \times k_q \times k_\lambda \times k_l \times WL}$$

Permissible load current I_n' of the selected fuse link:

$$I_n' = k_u \times k_q \times k_l \times k_\lambda \times WL \times I_n$$

2. Checking the permissible overload duration of current blocks exceeding the permissible fuse load current I_n' .

Melting time t_{VS} (time/current characteristic curve) \times residual value factor $RW \geq$ overload duration t_k

To do this, you require the previous load ratio

$$V = \frac{I_{\text{eff}}}{I_n'}$$

as well as the characteristic curve "permissible overload and melting time for previous load" (page 144, curve a) and the "time/current characteristic curve" for the selected fuse link.

If a determined overload duration is less than the respective required overload duration, then you need to select a fuse link with a greater rated current I_n (taking into account the rated voltage U_n and the permissible breaking I^2t value) and repeat the check.

Continuous load

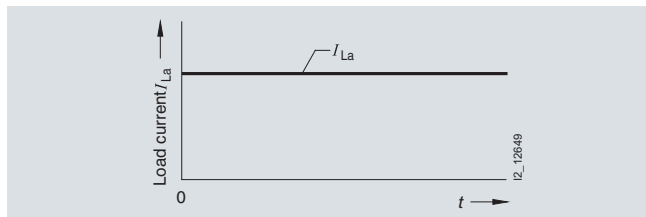

Rated current U_n of the fuse link

$$I_n \geq I_{L.a} \times \frac{1}{k_u \times k_q \times k_\lambda \times k_l \times WL}$$

$I_{L.a}$ = load current of the fuse link (r.m.s. value)

Fewer than 1 shutdown per week: $WL = 1$

More than 1 shutdown per week: $WL =$ see technical specifications, page 84 ff.

¹⁾ In the case of varying loads that cannot be assigned to one of the four types of load shown here, please contact us.

Unknown varying load, but with known maximum current I_{max}

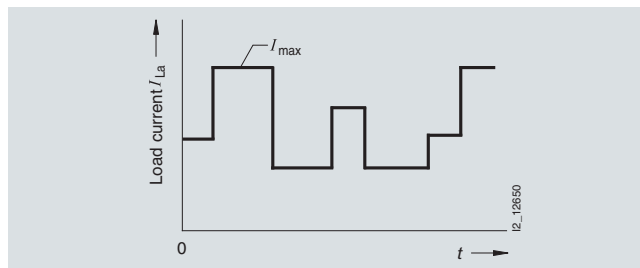

Rated current U_n of the fuse link

$$I_n \geq I_{\text{max}} \times \frac{1}{k_u \times k_q \times k_\lambda \times k_l \times WL}$$

I_{max} = maximum load current of the fuse link (r.m.s. value)

Varying load with known load cycle

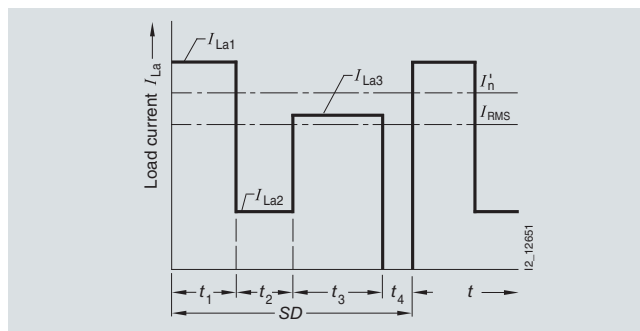

$$I_{\text{eff}} = \sqrt{\frac{\sum_{k=1}^{k=n} I_{Lak}^2 \times t_k}{SD}}$$

$$I_{\text{eff}} = \sqrt{\frac{I_{La1}^2 t_1 + I_{La2}^2 t_2 + I_{La3}^2 t_3}{SD}}$$

I_{Lk} = maximum load current of the fuse link (r.m.s. value)

Occasional surge load from preloading with unknown surge outcome

Specifying the required rated current I_n of the fuse link is carried out in two steps:

1. Specifying the rated current I_n on the basis of the previous load current I_{prev} :

$$I_n > I_{vor} \times \frac{1}{k_u \times k_q \times k_\lambda \times k_1 \times WL}$$

Permissible load current I_n' of the selected fuse link:

$$I_n' = k_u \times k_q \times k_\lambda \times k_1 \times WL \times I_n$$

2. Checking the permissible overload duration of the surge current I_{surge}

Melting time t_{vs} (time/current characteristic curves) \times residual value factor $RW \geq$ surge wave duration t_{surge}

To do this, you require the previous load ratio

$$V = \frac{I_{eff}}{I_n'}$$

as well as the characteristic curve "permissible overload and melting time for previous load" (page 144, curve a or b) and the "time/current characteristic curve" for the selected fuse link.

If a determined overload duration is less than the required overload duration t_{surge} , then you need to select a fuse link with a greater rated current I_n (taking into account the rated voltage U_n and the permissible breaking I^2t value) and repeat the check.

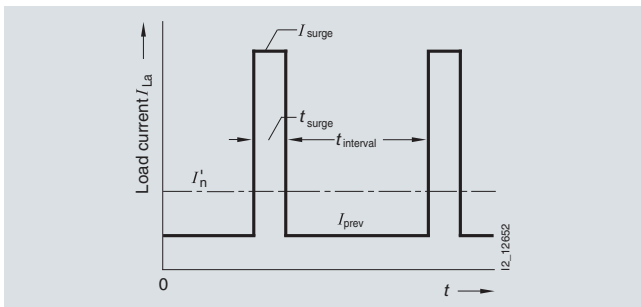

Condition:

$$t_{interval} \geq 3 \times t_{surge}$$

$$t_{interval} \geq 5 \text{ min}$$

Sample selections

For a converter assembly in circuit (B6) A (B6) C, whose rated direct current is $I_{dn} = 850 \text{ A}$, fuse links that can be installed as arm fuses should be selected. The choice of fuse is shown for different operating modes of the converter assembly.

Data for converter assembly

- Supply voltage
 $U_N = 3 \text{ AC } 50 \text{ Hz } 400 \text{ V}$
- Recovery voltage
 $U_W = 360 \text{ V} = U_N \times 0.9$ (for shoot-throughs)
- Thyristor T 508N (from eupec),
 I^2t value
 $\int I^2 dt = 320 \times 10^3 \text{ A}^2\text{s}$ (10 ms, cold)
- Fuse links, natural air cooling,
ambient temperature $\vartheta_U = +35 \text{ }^\circ\text{C}$
- Conductor cross-section for copper fuse link: 160 mm^2
- Conversion factor
direct current I_d /fuse load current I_{La} : $I_{La} = I_d \times 0.58$.

For the following examples, it is assumed, in the case of loads that exceed the rated direct current of the converter assembly, that the converter assembly is rated for this load.

Continuous, no-break load

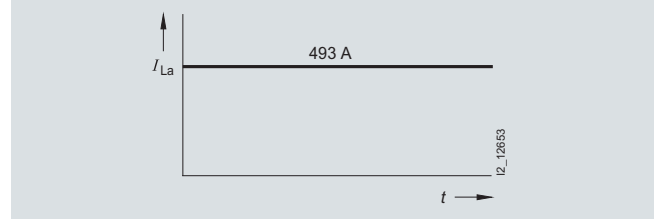

Direct current $I_d = I_{dn} = 850 \text{ A}$

$$I_{La} = I_d \times 0.58 = 493 \text{ A}$$

Selected:

3NE3 335 SITOR fuse link

(560 A/1000 V), $WL = 1$

breaking I^2t value

$$I^2t_a = 360 \times 10^3 \times 0.53 = 191 \times 10^3 \text{ A}^2\text{s}$$

test cross-section to page 139: 400 mm^2

The following correction factors are to be applied:

$$k_u = 1.02 \quad (\vartheta_U = +35 \text{ }^\circ\text{C})$$

$$k_q = 0.91 \quad (\text{conductor cross-section, double-ended, 40 \% of test cross-section})$$

$$k_\lambda = 1.0 \quad (\text{conduction angle } \lambda = 120^\circ)$$

$$k_1 = 1.0 \quad (\text{no forced-air cooling})$$

Required rated current I_n of the SITOR fuse link:

$$I_n \geq I_{La} \times \frac{1}{k_u \times k_q \times k_\lambda \times k_1 \times WL} =$$

$$493 \text{ A} \times \frac{1}{1,02 \times 0,91 \times 1,0 \times 1,0 \times 1,0} = 531 \text{ A}$$

Unknown varying load, but with known maximum current

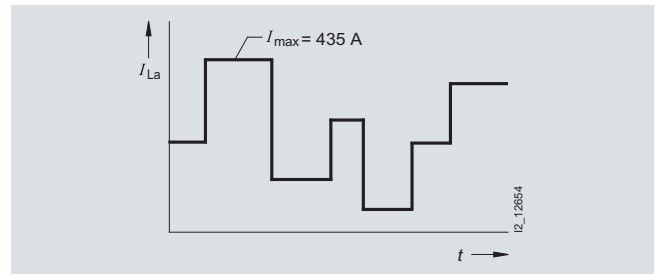

Max. direct current $I_{dmax} = 750 \text{ A}$

$$\text{Max. fuse current } I_{max} = I_{dmax} \times 0.58 = 435 \text{ A}$$

Selected:

3NE3 334-0B SITOR fuse link

(560 A/1000 V), $WL = 1$

Breaking I^2t value

$$I^2t_a = 260 \times 10^3 \times 0.53 = 138 \times 10^3 \text{ A}^2\text{s}$$

Test cross-section to page 139: 400 mm^2

The following correction factors are to be applied:

$$k_u = 1.02 \quad (\vartheta_U = +35 \text{ }^\circ\text{C})$$

$$k_q = 0.91 \quad (\text{conductor cross-section, double-ended, 40 \% of test cross-section})$$

$$k_\lambda = 1.0 \quad (\text{conduction angle } \lambda = 120^\circ)$$

$$k_1 = 1.0 \quad (\text{no forced-air cooling})$$

Required rated current I_n of the SITOR fuse link:

$$I_n \geq I_{max} \times \frac{1}{k_u \times k_q \times k_\lambda \times k_1 \times WL} =$$

$$435 \text{ A} \times \frac{1}{1,02 \times 0,91 \times 1,0 \times 1,0 \times 1,0} = 469 \text{ A}$$

Fuse systems

SITOR semiconductor fuses

Configuration

Varying load with known load cycle

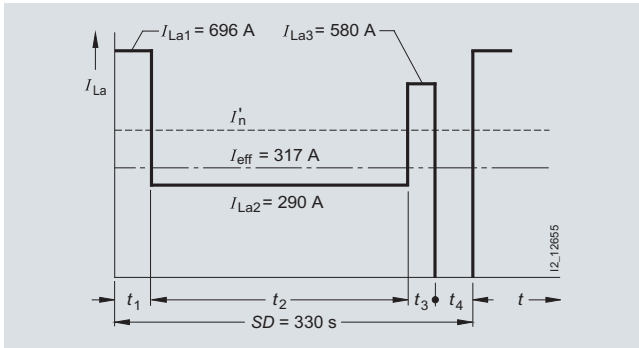

Direct current:

$$\begin{aligned} I_{d1} &= 1200 \text{ A} & t_1 &= 20 \text{ s} \\ I_{d2} &= 500 \text{ A} & t_2 &= 240 \text{ s} \\ I_{d3} &= 1000 \text{ A} & t_3 &= 10 \text{ s} \\ I_{d4} &= 0 \text{ A} & t_4 &= 60 \text{ s} \end{aligned}$$

Fuse current:

$$\begin{aligned} I_{La1} &= 1200 \times 0.58 = 696 \text{ A} \\ I_{La2} &= 500 \times 0.58 = 290 \text{ A} \\ I_{La3} &= 1000 \times 0.58 = 580 \text{ A} \end{aligned}$$

R.m.s. value of load current

$$I_{\text{eff}} = \sqrt{\frac{696^2 \times 20 + 290^2 \times 240 + 580^2 \times 10}{330}} = 317 \text{ A}$$

Selected unit:

3NE3 333 SITOR fuse link
(450 A/1000 V), $WL = 1$
breaking I^2t value $I_{ta}^2 = 175 \times 10^3 \times 0.53 = 93 \times 10^3 \text{ A}^2\text{s}$
test cross-section to page 139: 320 mm²

The following correction factors are to be applied:

$$\begin{aligned} k_U &= 1.02 \quad (\vartheta_U = +35 \text{ }^\circ\text{C}) \\ k_Q &= 0.94 \quad (\text{conductor cross-section, double-ended, 50 \% of test cross-section}) \\ k_\lambda &= 1.0 \quad (\text{conduction angle } \lambda = 120^\circ) \\ k_1 &= 1.0 \quad (\text{no forced-air cooling}) \end{aligned}$$

1. Required rated current I_n of the SITOR fuse link:

$$\begin{aligned} I_n &\geq I_{\text{eff}} \times \frac{1}{k_U \times k_Q \times k_\lambda \times k_1 \times WL} = \\ 317 \text{ A} &\times \frac{1}{1,02 \times 0,94 \times 1,0 \times 1,0 \times 1,0} = 331 \text{ A} \end{aligned}$$

Permissible load current I_n' of the selected fuse link:

$$I_n' = k_U \times k_Q \times k_\lambda \times k_1 \times WL \times I_n = 1.02 \times 0.94 \times 1.0 \times 1.0 \times 1.0 \times 450 = 431 \text{ A}$$

2. Checking the permissible overload duration of current blocks exceeding the permissible fuse load current I_n'

Previous load ratio:

$$V = \frac{I_{\text{eff}}}{I_n'} = \frac{317}{431} = 0,74$$

Residual value factor RW : For $V = 0.74$ of curve a (characteristic curve page 144, frequent surge/load cycle currents) $RW = 0.2$

Current block I_{La1} : melting time t_{vs} : 230 s
(from time/current characteristic curve for 3NE3 333)
 $t_{vs} \times RW = 230 \text{ s} \times 0.2 = 46 \text{ s} > t_1$

Current block I_{La3} : melting time t_{vs} : 1200 s
(from time/current characteristic curve for 3NE3 333)
 $t_{vs} \times RW = 1200 \text{ s} \times 0.2 = 240 \text{ s} > t_3$

Occasional surge load from preloading with unknown surge outcome

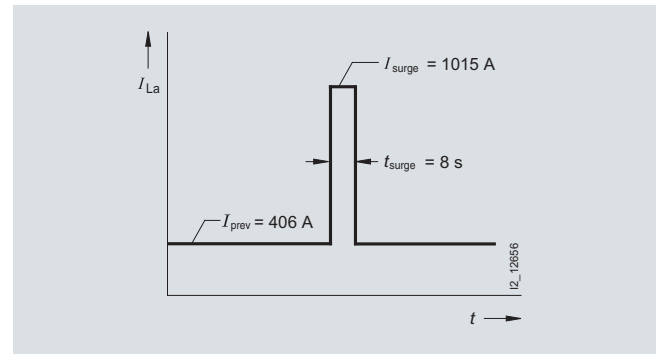

Direct current:

$$\begin{aligned} I_{d\text{prev}} &= 700 \text{ A} \\ I_{d\text{surge}} &= 500 \text{ A} & t_{\text{surge}} &= 8 \text{ s} \end{aligned}$$

Fuse current:

$$\begin{aligned} I_{\text{prev}} &= I_{d\text{prev}} \times 0.58 = 406 \text{ A} \\ I_{\text{surge}} &= I_{d\text{surge}} \times 0.58 = 1015 \text{ A} \end{aligned}$$

Conditions:

$t_{\text{interval}} \geq 3 t_{\text{surge}}$ and $t_{\text{interval}} \geq 5 \text{ min}$ must be fulfilled.

Selected unit:

3NE3 333 SITOR fuse link
(560 A/1000 V), $WL = 1$
breaking I^2t value $I_{ta}^2 = 360 \times 10^3 \times 0.53 = 191 \times 10^3 \text{ A}^2\text{s}$
test cross-section to page 139: 400 mm²

The following correction factors are to be applied:

$$\begin{aligned} k_U &= 1.02 \quad (\vartheta_U = +35 \text{ }^\circ\text{C}) \\ k_Q &= 0.91 \quad (\text{conductor cross-section, double-ended, 40 \% of test cross-section}) \\ k_\lambda &= 1.0 \quad (\text{conduction angle } \lambda = 120^\circ) \\ k_1 &= 1.0 \quad (\text{no forced-air cooling}) \end{aligned}$$

1. Required rated current I_n of the SITOR fuse link:

$$\begin{aligned} I_n &\geq I_{\text{prev}} \times \frac{1}{k_U \times k_Q \times k_\lambda \times k_1 \times WL} = \\ 406 \text{ A} &\times \frac{1}{1,02 \times 0,91 \times 1,0 \times 1,0 \times 1,0} = 437 \text{ A} \end{aligned}$$

Permissible load current I_n' of the selected fuse link:

$$I_n' = k_U \times k_Q \times k_\lambda \times k_1 \times WL \times I_n = 1.02 \times 0.91 \times 1.0 \times 1.0 \times 1.0 \times 560 = 520 \text{ A}$$

2. Checking the permissible overload duration of the surge current I_{surge}

Previous load ratio:

$$V = \frac{I_{\text{prev}}}{I_n'} = \frac{406}{520} = 0,78$$

Residual value factor RW : For $V = 0.78$ of curve a (characteristic curve page 144, frequent surge/load cycle currents) $RW = 0.18$ surge current I_{surge} : melting time t_{vs} : 110 S (from time/current characteristic curve for 3NE3 333)
 $t_{vs} \times RW = 110 \text{ s} \times 0.18 = 19.8 \text{ s} > t_{\text{surge}}$ correction factors can be found on pages 139 and 140.

Overview

Special requirements are placed on fuses for application in photovoltaic devices. These fuses have a high DC rated voltage of DC 1000 V or more and a disconnect characteristic configured on the protection of the PV modules and their connecting cables (the newly defined operational class gPV). Greatly varying load currents and a wide temperature range continue to play an important role.

Only in the course of last few years were the requirements incorporated in an international standard, which is currently released as the draft standard IEC 60269-6. All Siemens PV fuses comply with this new standardization.

The cylindrical fuses size 10x38 are used for the protection of trains. The cylindrical fuse holders are supplied with one and two poles and with or without signal detectors. In the case of devices with signal detector, a small electronic device with LED is located behind an inspection window in the plug-in module. If the inserted fuse link is tripped, this is indicated by the LED flashing.

The fuse holders size 10 mm x 38 mm have a sliding catch that enables the removal of individual devices from the assembly. The infeed can be from the top or the bottom. Because the cylindrical fuse holders are fitted with the same anti-slip terminals at the top and the bottom, the devices can also be bus-mounted at the top or the bottom.

The cylindrical fuse holders comply with IEC 60269-2 and are regarded as fuse disconnectors in the sense of the switching device standard IEC 60947. Under no circumstances are they suitable for switching loads.

The correct selection and dimensioning of these fuses must take account of the specific operating conditions as well as the data of the PV modules when calculating the voltage and the current.

Technical specifications

Cylindrical fuse holders

		3NW7 0...-4 cylindrical fuse holders
Sizes	mm x mm	10 x 38
Standards		IEC 60269, IEC 60269-6 (draft), IEC 60947
Approvals		UL 712 (available soon)
Rated voltage U_n	V DC	1000
Rated current I_n	A DC	25
Rated short-circuit strength	kA	30
Switching capacity		
• Utilization category		AC-20B, DC-20B (switching without load)
Max. power dissipation of the fuse link	W	3.4
Rated impulse withstand voltage	kV	6
Overvoltage category		II
Pollution degree		2
No-voltage changing of fuse links		Yes
Sealable when installed		Yes
Mounting position		Any, but preferably vertical
Current direction		Any (signal detector with antiparallel LED)
Degree of protection acc. to IEC 60529		IP20, with connected conductors
Terminals are touch-protected acc. to BGVA3 at the incoming and outgoing feeder		Yes
Ambient temperature	°C	-25 ... +55, Humidity 90 % at +20
Conductor cross-sections		
• finely stranded, with end sleeve mm ²		0.75 ... 25
• AWG (American Wire Gauge)		18 ... 4
Tightening torques	Nm	1.2

Cylindrical fuse links

		3NW6 0...-4 cylindrical fuse links
Sizes	mm x mm	10 x 38
Standards		IEC 60269-6 (draft)
Approvals		UL 248-13 (available soon)
Operational class		gPV
Rated voltage U_n	V DC	1000 at time constant (L/R) 3 ms
Rated current I_n	A DC	4 ... 16
Rated breaking capacity	kA DC	30
Mounting position		Any, but preferably vertical
Ambient temperature	°C	-25 ... +55, Humidity 90 % at +20

Fuse systems

Photovoltaic fuses

Cylindrical fuse design, 3NW7 0, 3NW6 0

Characteristic curves

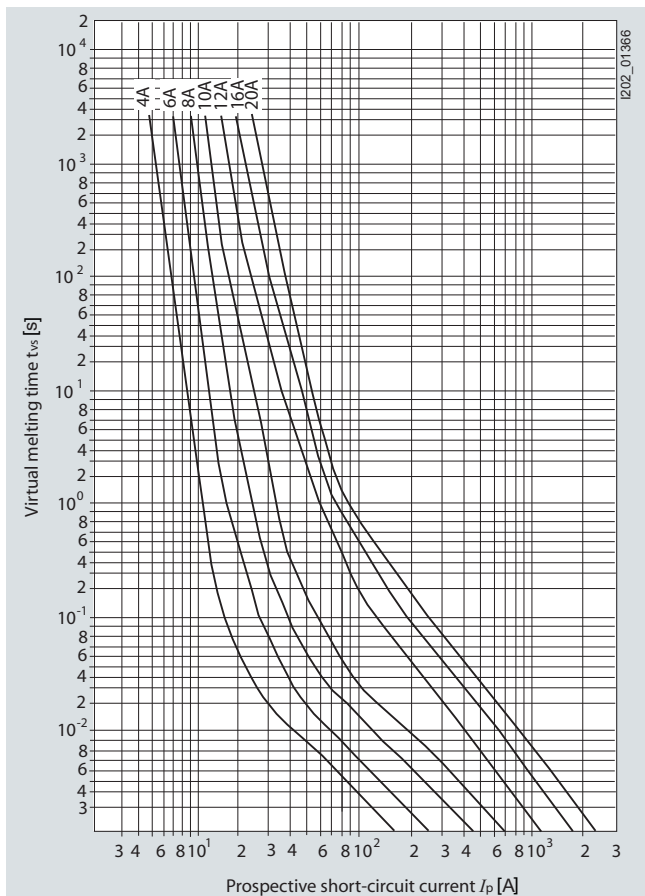

Time/current characteristics diagram

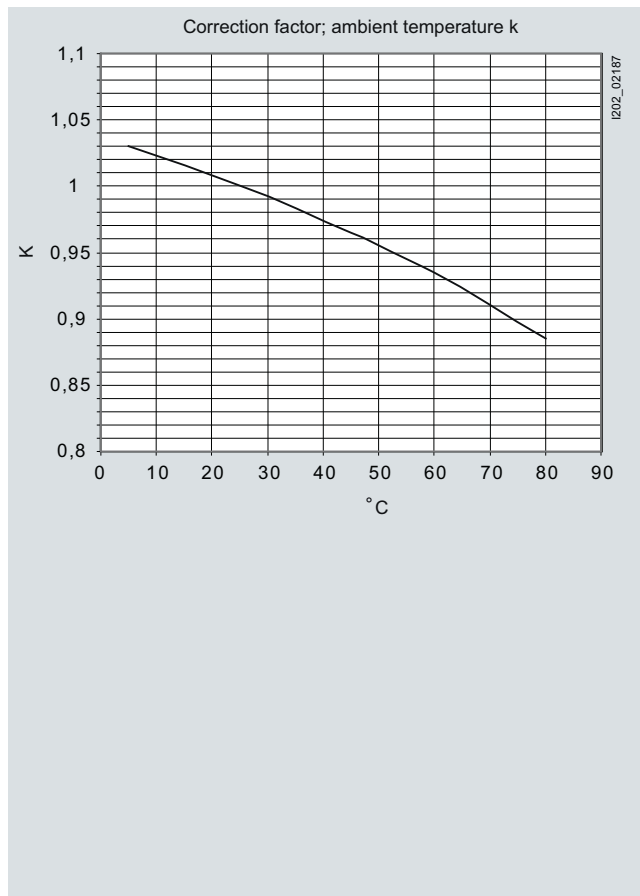

Characteristic curves diagram Correction factor Ambient temperature

Dimensional drawings

3NW6 00.-4

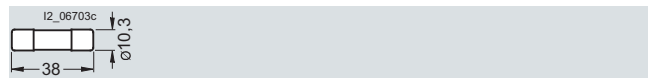

10 x 38 mm

3NW7 0.-4

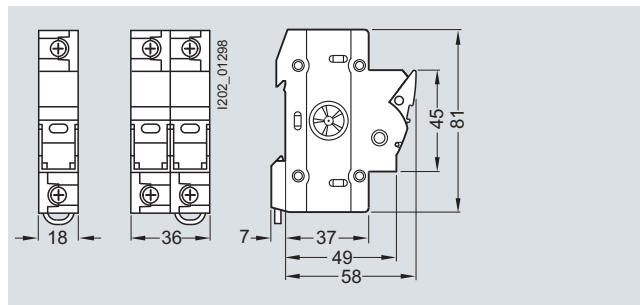

1-pole 2-pole

Schematics



1-pole

2-pole

More information

Selecting and dimensioning photovoltaic fuses from Siemens

Standards:

The contents of the new standard IEC 60269-6 are currently being drawn up.

We follow this new standard when rating and labeling our PV fuses. Until now, some of our rivals have been relying on products based on the standard IEC 60269-4 "Fuses for semiconductor protection". Differences between the two standards are particularly evident for the rated voltage and the test voltage and in the definition of the operational class.

Terms:

$U_{OC\ STC}$ (also known as $V_{OC\ STC}$)¹⁾

Voltage under standard test conditions on an unloaded train taking into account minimum ambient temperature (no-load voltage). The voltage $U_{OC\ STC}$ of a train is obtained by multiplying the single voltages $U_{OC\ STC}$ of a PV module ($U_{OC\ STC} \times M^2$).

$I_{SC\ STC}$

Short-circuit current of a PV module, a PV train, a PV sub-generator or a PV generator under standard test conditions

I_{MPP}

is the largest possible working current of a train (MPP = Maximum Power Point).

$I_{D\ max}$

Is the maximum occurring load current; this is usually equivalent to I_{MPP}

$I_{SC\ MOD}$

Short-circuit current of a PV module under regional conditions.

Standard test conditions (STC)

Test conditions which are laid down in EN 60904-3 for PV cells and PV modules:

- Solar radiation 1000 W/m²
- Ambient temperature 25 °C
- Air distribution (AM) 1.5

Standard test conditions are normally specified by the manufacturer of the PV module in data sheets.

Operational class

We use draft standard IEC 60269-6 as a guide when naming the operational class gPV. Accordingly, the symbols are also on the fuse:

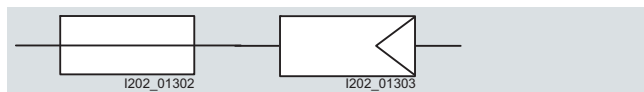

It is important that the fuse have a full-range characteristic which can cut off with certainty all possible fault currents, and especially also small fault currents³⁾.

The test currents for PV fuses are defined in draft standard IEC 60269-6.

$I_{nf} = 1.13 \times I_n$ (test current at which the fuse must not trip for one hour).

$I_f = 1.45 \times I_n$ (test current at which the fuse must trip for one hour).

Please refer to the time/current characteristic curve diagram on page 152.

Rated switching capacity

Under draft standard IEC 60269-6 a rated switching capacity of at least 10 kA is required. While this is comparatively low compared to other fuses, it is more than adequate for handling the residual currents occurring in PV systems.

We have tested our PV fuses at 30 kA.

Dimensioning rules

PV fuses are to be dimensioned according to special rules with regard to rated voltage, rated current and operational class (characteristic).

Dimensioning rule

The rated voltage⁴⁾ of the fuse should be calibrated 20 % higher than the open-circuit voltage $U_{OC\ STC}$ of a train. Extreme operating conditions, e. g. temperatures down to -25 °C, are thus taken into account.

Rated voltage

Our PV fuses have been tested according to draft standard IEC 60269-6 with the rated voltage, i.e. the test voltage is the same as the rated voltage.

Based on IEC 60269-4, some manufacturers have issued two voltage values for their fuses, e. g. 900 V (tested 1000 V).

Rated current

1. In order to prevent unwanted tripping of the PV fuse during normal operation and in case of a fault in a different train that is connected in parallel, the rated current of the PV fuse must be greater than the short-circuit current I_{SC} of the respective module or train: $I_n \geq 1.4 I_{SC}$.

The value 1.4 was determined in draft standard IEC 60269-6 and should apply to the simple dimensioning of the fuse.

This value contains the following correction factors for the standard test conditions:

A higher ambient temperature of 45 °C, a higher solar radiation of 1200 W/m² and the reduction due to the variable loading.

An additional reduction must be used when several fuse holders are bundled.

According to EN 60469-1, Table 1, the following reduction factors must be applied:

Number of main circuits	Rated diversity factor
2 and 3	0.9
5 and 6	0.8
6 ... 9	0.7
10 and more	0.6

Since the fuses are only operated with around 70 to 80 % of the load current, a further reduction is only necessary after around six auxiliary circuits (e. g. three two-pole devices), including also where the fuses only have maximum power dissipation of 3.4 W.

1) Voltage of the unloaded circuit under standard test conditions

2) M is the number of PV modules connected in series in a train.

3) Note: a difference in the overload current and the short-circuit current is not meaningful when protecting PV systems, because even for a short circuit, only small currents occur, which are not designated as short-circuit currents in terms of the standards of overcurrent protective devices. Therefore in the following we shall refer to fault currents.

4) Note: Unlike with mechanical switching devices, when two fuses (positive pole and negative pole) are used, you cannot count on a division of the voltage in the event of residual current tripping. Accordingly every fuse must be dimensioned with the full rated voltage.

Cylindrical fuse design, 3NW7 0, 3NW6 0

Fuses with a lower rated current have a lower power dissipation, so that the reduction is considerably less. The 10 A fuse fuse for example has a rated power dissipation of 1.5 W, with the result that no reduction is necessary here.

In the event of extreme solar radiation a further reduction of the rated current of the fuse may be necessary.

The short circuit current $I_{SC\ MOD}$ is dependent on regional climatic circumstances. Under particular climatic circumstances and cloud arrangements, in particular high in the mountains, higher values for the solar radiation than the 1200 W/m² used above may by all means occur (above: simplified calculation). In order to incorporate the peak values into the calculation, we recommend using the following correction factors.

Climate zone	Max. solar radiation	Correction factor
Standard test conditions	1000 W/m ²	1
Moderate climate zone	1200 W/m ²	1.2
Moderate climate zone/high mountains	1400 ... 1600 W/m ²	1.4 ... 1.6
Africa	1400 ... 1600 W/m ²	1.4 ... 1.5

The rated current of the fuse refers to an ambient temperature of 25 °C.

Cut-off performance will change at higher temperatures. A further reduction may be required for an ambient temperature higher than the ambient temperature used above (+45 °C).

2. To protect the modules and their connecting cables, the PV fuse should disconnect reliably and in time.

Residual currents can result from faulty modules, double ground faults or incorrect wiring. The PV modules are rated so that they can continuously withstand the residual current in the forward direction without any problems.

However, fault currents which flow through the train or the PV module in a reverse direction are particularly critical.

This fault current $I_{SC\ REVERSE}$ is calculated from the number of parallel connected trains $n-1$ multiplied by the short circuit current $I_{SC\ MOD}$ of a train or module.

$$I_{SC\ REVERSE} = n-1 \times I_{SC\ MOD}$$

This $I_{SC\ MOD}$ is likewise dependent on the regional circumstances described above:

$$I_{SC\ MOD} = 1.2^{1)} \times I_{SC\ STC}$$

Only above $n = 3$ parallel trains are PV phase fuses meaningful at all.

In order to protect the PV module against reverse currents $I_{SC\ REVERSE}$ which have a value higher than the reverse current resistance of the PV module $I_{MOD\ REVERSE}$, the "cut-off current" of the PV fuse must be of a smaller size than the permitted and tested reverse current resistance of the module.

You can dispense with PV fuses if the reverse current resistance of the PV modules is greater than the residual current:

$$I_{MOD\ REVERSE} > I_{SC\ REVERSE}$$

The manufacturers of the modules normally test their modules with a 1.35x reverse current, for two hours.

For protection, you therefore need a fuse that disconnects earlier under these conditions.

The PV fuses have a "disconnect current" (generally referred to as large test current I_f), which causes the fuse to disconnect at 1.45 x the rated current in less than one hour (at the latest).

In order to connect the tested reverse current resistance of the PV module $I_{MOD\ REVERSE}$ with the cut-off performance of the fuse, we recommend the use of a conversion rate of 0.9.

For the rated current of the PV fuse, I_n produces the following dimensioning rules:

$$I_n \leq 0.9 \times I_{MOD\ REVERSE}$$

This does not consider possible fault currents, if any, which are fed by the back-up batteries and/or the solar converters.

Protection of the factory-fitted connecting cables of the PV module should be mainly ensured by the manufacturer.

Connecting cables/wires of a train must be able to withstand n times the short-circuit $I_{SC\ MOD}$. As with other cables and wires, the following simple relationship applies:

$$I_n \leq I_z^{2)}$$

If several trains connected in parallel are grouped together, the aforementioned dimensioning rules also apply. The rated current of the PV fuse group should be at least 1.2¹⁾ times greater than the total of the short-circuit currents of the group.

1) Climate zone-dependent correction factor 1.2 ... 1.6
(see the table on page 154).

2) I_z is the permitted capacity of the line/cable.

Siemens AG
Industry Sector
Building Technologies Division
Low Voltage Distribution
Postfach 10 09 53
93009 REGENSBURG
GERMANY

www.siemens.com/lowvoltage

Subject to change without prior notice
PDF only
3P.8303.54.27
PH 0611 152 En
© Siemens AG 2011

The information provided in this configuration Manual contains descriptions or characteristics of performance which in case of actual use do not always apply as described or which may change as a result of further development of the products. An obligation to provide the respective characteristics shall only exist if expressly agreed in the terms of contract. Availability and technical specifications are subject to change without notice.

All product designations may be trademarks or product names of Siemens AG or supplier companies whose use by third parties for their own purposes could violate the rights of the owners.