

Measuring Devices and E-Counters

Configuration Manual · 10/2010



SETRON

Answers for infrastructure.

SIEMENS

Measuring Devices and E-Counters













4	Introduction
	E-counters
8	PAC1500 three-phase counters
12	PAC1500 single-phase counters
	Power monitoring devices
17	PAC3000 multimeters
21	PAC3000 multicounters
27	LAN couplers, 7KT1 391
30	PAC3100, PAC3200 and PAC4200 power monitoring devices
32	PAC PROFIBUS DP expansion modules
33	PAC RS485 expansion modules
34	PAC 4DI/2DO expansion modules for PAC4200
	Analog volt- and ammeters
35	7KT1 0 measuring devices
	Digital volt- and ammeters
36	7KT1 11, 7KT1 12 measuring devices
	Time and pulse counters
38	Time and pulse counters for standard rail mounting, 7KT5 8
40	Time counters for front-panel mounting, 7KT5 5, 7KT5 6
	Accessories
42	Current transformers, 7KT1 2
43	Measuring selector switches, 7KT9 0
	Technical information
	can be found at www.siemens.com/lowvoltage/support
	under Product List:
	- Technical Specifications
	under Entry List:
	- Updates
	- Download
	- FAQ
	- Manuals
	- Characteristics
	- Certificates
	and at www.siemens.com/lowvoltage/configurators
	- Configurators

Measuring devices and E-counters

Introduction







Overview

Devices	Page	Application	Standards	Used in		
				Non-residential buildings	Residential buildings	Industry
E-counters						
	8	Measurement of consumption data and plant capacity utilization in three-phase systems of system components, offices or holiday apartments.	EN 50470-1, EN 50470-3 EN 62052-23, EN 62053-31	✓	✓	✓
	12	For the measurement of kWh in single-phase systems, e.g. in industrial plants, offices and apartments in apartment houses	EN 50740-1, EN 50470-3, EN 62053-31	✓	✓	✓
Power monitoring devices						
	17	Display of 23 electrical measured values for switchgear assemblies, infeed or outgoing feeders. Easy commissioning due to fault detection if connected incorrectly.	IEC 60051-2, EN 60051-2 IEC 61010-1, EN 61010-1 (VDE 0411 T 1)	✓	--	✓
	21	Display of 35 electrical measured values and consumption values in switchgear assemblies, infeed or outgoing units. Easy commissioning due to fault detection if connected incorrectly.	IEC 60051-2, EN 60051-2 IEC 61010-1, EN 61010-1 (VDE 0411 T 1) IEC 62053-21, EN 62053-21 (VDE 0418 T 3-21)	✓	--	✓
	27	Up-to-date consumption data of multi-counters and E-counters available worldwide using LAN data communication.	IEEE 802	✓	--	✓

Devices	Page	Application	Standards	Used in		
				Non-residential buildings	Residential buildings	Industry
 <p>PAC3100 power monitoring devices AC/DC power supply unit with screw connection</p>	30	<p>Display of 30 electrical measured values and consumption values in switchgear assemblies, infeed or outgoing units.</p> <p>International standards and multi-lingual displays for worldwide use.</p> <p>Control panel flush-mounting instrument with graphics display, integrated digital inputs and outputs and a RS 485 interface (Modbus RTU) for the transfer of measured values and for configuration.</p>	IEC 61557-12	✓	--	✓
 <p>PAC3200 power monitoring devices 3 versions:</p> <ul style="list-style-type: none"> AC/DC power supply unit with screw connection DC power supply unit with extra-low voltage, screw connection AC/DC power supply unit with ring terminal lug connection 	30	<p>Display of over 50 electrical measured values for switchgear assemblies, infeed or outgoing feeders. 10 dual-tariff energy counters for precise energy monitoring for power draw and feedback.</p> <p>International standards and multi-lingual displays for worldwide use.</p> <p>Control panel flush-mounting instrument with graphics display, integrated digital inputs and outputs and an integrated Ethernet interface (Modbus TCP) for the transfer of measured values and for configuration. Option modules for Modbus RTU (RS 485) or PROFIBUS DP can be plugged in.</p>	IEC 62053 (only energy measurement)	✓	--	✓
 <p>PAC4200 power monitoring devices 2 versions:</p> <ul style="list-style-type: none"> AC/DC power supply unit with screw connection AC/DC power supply unit with ring terminal lug connection 	30	<p>Display of over 200 electrical measured values for switchgear assemblies, infeed or outgoing feeders. Extensive functions for precise energy-monitoring for power draw and feedback and for appraisal of network quality.</p> <p>International standards and multi-lingual displays for worldwide use.</p> <p>Control panel flush-mounting instrument with graphics display, user-defined displays, memory, clock and calendar function, digital in- and outputs and an integrated Ethernet interface (Modbus TCP) with gateway function to transfer measured values and configurations. Option modules for Modbus RTU (RS 485) or PROFIBUS DP can be plugged in.</p>	IEC 61557-12	✓	--	✓
 <p>PAC PROFIBUS DP expansion modules</p>	32	The SENTRON PAC PROFIBUS DP expansion module is used to connect the PAC3200 and PAC4200 power monitoring devices to the RS 485.		✓	--	✓
 <p>PAC RS485 expansion modules</p>	33	The SENTRON PAC PROFIBUS DP expansion module is used to connect the PAC3200 and PAC4200 power monitoring devices to the PROFIBUS DP- V1.		✓	--	✓
 <p>PAC 4DI/2DO expansion modules</p>	34	The SENTRON PAC 4DI/2DO expansion module is used to expand the SENTRON PAC4200 power monitoring device to up to 10 digital inputs and 6 digital outputs.	IEC 62053-31	✓	--	✓

Measuring devices and E-counters

Introduction

Devices	Page	Application	Standards	Used in		
				Non-residential buildings	Residential buildings	Industry
Analog measuring devices						
 <p>Analog voltmeters and ammeters, 7KT1 0</p>	35	Voltage and current measurement for monitoring incoming and outgoing currents as well as device currents in order to prevent plant overload.	IEC 60051-2, EN 60051-2	✓	--	✓
Digital measuring devices						
 <p>Digital voltmeters and ammeters, 7KT1 11, 7KT1 12</p>	36	Voltage and current measurement with large 3-digit LEDs for monitoring incoming and outgoing currents as well as device currents in order to prevent plant overload.	DIN 43751-1, DIN 43751-2	✓	--	✓
Time and pulse counters						
 <p>Time and pulse counters for standard rail mounting, 7KT5 8</p>	38	For monitoring operating hours and starting operations for planning preventative maintenance tasks and preventing sudden shutdowns	IEC 60255-6, EN 60255-6, (VDE 0435-301), UL 94	✓	✓	✓
 <p>Time counters for front-panel mounting, 7KT5 5, 7KT5 6</p>	40	For monitoring operating hours and starting operations for planning preventative maintenance tasks and preventing sudden shutdowns.	IEC 60255-6, EN 60255-6 (VDE 0435-301)	✓	✓	✓
Accessories						
 <p>Current transformers, 7KT1 2</p>	42	Straight-through transformers for installation in distribution boards and non-contact measuring of primary currents. Ideal for combining with switch disconnectors, multimeters, multimeters and E-counters.	IEC 60044-1, EN 60044-1 (VDE 0414 T 44-1)	✓	--	✓
 <p>Measuring selector switches, 7KT9 0</p>	43	For switching over the phases for voltmeters and ammeters		✓	--	✓

Overview



PAC 1500 three-phase counter with direct connection up to 80 A and transformer current connection ... /5 A

The E-counters (power meters) are used to record the amount of electrical energy exported or imported. Siemens compact E-counters are designed as modular devices for alternating current and can be mounted on standard mounting rails. They comply with the counter standard EN 50470 (Part 1 and 3) and come with an LCD display.

Three-phase counters for direct connection are available up to 80 A and in versions with transformer connections (.../5 A to 10000/5 A).

E-counters store both active and reactive energy, and comply with accuracy class 1 (for active energy).

All E-counters have a pulse output (S0) and are designed for 2-tariff measurements. The calibrated versions are in accordance with the new Measuring Instruments Directive 2004/22/EC (MID).

At the same time the E-counters have an integrated optical interface (IrDA) for connecting communication modules, which enables their integration in a range of other systems, such as energy management systems.

Technical specifications

PAC1500 three-phase E-counters		7KT1 543 7KT1 545	7KT1 540
Standards		EN 50470-1, EN 50470-3, EN 62053-23, EN 62053-31	
Connection		80 A	--
<ul style="list-style-type: none"> • Direct connection • Transformer current connection 		--	.../5 A
General data			
• Enclosure, mounting width	Acc. to DIN 43880	MW	4
• Mounting	Acc. to EN 60715		35 mm
• Mounting height		mm	70
Function			
<ul style="list-style-type: none"> • Operating mode • Storage of setting and counter reading • Tariff for active and reactive energy 	Three-phase loads Through (EEPROM)	Conductors	2-3-4 Yes T1/T2
Supply (through measuring terminals)			
• Rated control supply voltage U_n		V AC	230
• Voltage range		V	184 ... 276
• Rated frequency f_n		Hz	50
• Rated power dissipation P_V		VA (W)	≤ 8 (0.6)
Overload capability			
• Voltage U_{max}	Continuous operation: Phase/phase	V	480
	1 second: Phase/phase	V	800
	Continuous operation: Phase/N	V	276
	1 second: Phase/N	V	300
• Current I_{max}	Continuous operation	A	80
	Short-time operation (for 0.5 s)	A	--
	Short-time operation (for 10 ms)	A	2400
Display (readout)			
• Connection error and phase failure	Display of rotating field error		PHASE Err
• Display	LCD	Digits	8 (1 decimal point)
	Digit dimensions	mm x mm	6 x 3
• Active energy: 1 display, 8-digit + display import or export (arrow)	Tariff/tariffs	kWh	000000.0 ... 999999.9
	Max. display (continuous)	kWh	999999.9 ... 000000.0
• Reactive energy: 1 display, 8-digit + display import or export (arrow)	Tariff/tariffs	kvarh	000000.0 ... 999999.9
	Max. display (continuous)	kvarh	999999.9 ... 000000.0
• Instantaneous active power: 1 display, 3-digit		W, kW, MW	000 ... 999
• Instantaneous reactive power: 1 display, 3-digit		var, kvar, Mvar	000 ... 999
• Display tariff identification			T1/T2
• Transformer primary current	1 display, 1-digit		--
• Display period		s	5 ... 10000 2
Measuring accuracy		At 23 ±1 °C based on nominal value	
• Active energy and active power	Acc. to EN 50470-3	%	±1 (B)
• Reactive energy and reactive power	Acc. to EN 62053-23	%	±2

Measuring Devices and E-counters

E-counters

PAC1500 three-phase counters, 7KT1 5

PAC1500 three-phase E-counters			7KT1 543 7KT1 545	7KT1 540
Measuring inputs				
• Connection type			Direct	Transformer TA-TC .../5 A
• Voltage U_n	Phase/phase	V	400	
	Phase/N	V	230	
• Operating range voltage	Phase/phase	V	319 ... 480	
	Phase/N	V	184 ... 276	
• Current I_{ref}		A	15	--
• Current I_n		A	--	5
• Current I_{min}		A	0.75	0.05
• Operating range current ($I_{st} \dots I_{max}$)	Direct connection	A	0.0025 ... 80	--
	Transformer connection	A	--	0.010 ... 6
• Transformer current	Primary current of the transformer	A	--	5 ... 10000
	Smallest input step	A	--	5
• Frequency		Hz	50	
• Input ripple form			Symmetrical sinusoidal	
• Operational starting current I_{st}		mA	25	10
S0 interface			Acc. to EN 62053-31	
• Pulse outputs			Yes	
- For absorbed active and reactive energy T1 + T2			--	
• Pulse quantity			--	
- At 80 A		kWh	500	--
- Can be set on transformer		kWh	--	1000 - 10 - 1
• Pulse duration		ms	30 ± 5 ms	
• Required voltage		V AC	5 ... 230 ± 5 %	
		V DC	5 ... 300	
• Permissible current		mA	90	
• Permitted current		µA	1	
Optical interfaces				
• Calibration from the front (accuracy check)	LED	kWh	1000	10000
IR interface				
• At the side for connecting communication modules (M-Bus / Modbus RTU / RS 485 / KNX)			Yes	
Safety			Acc. to EN 50470-1	
• For indoor areas			Yes	
• Overvoltage category			4	
• Operational voltage		V	300	
• Test voltage	1.2/50 µs	kV	6	
• Flame resistance	UL 94	Class	V0	
• Seal between the top and bottom of the enclosure (mod. 7KT1 543)			Yes	
Terminal connections				
• Lift terminals of main current paths	Screw head Z ±	Pozidriv	PZ2	PZ1
• Lift terminals for S0 pulse outputs	Blade for slotted screw	mm x mm	0.8 x 3.5	0.8 x 3.5
• Conductor cross-sections of operational current and main current paths				
- Rigid		mm ²	1.5 ... 35	1.5 ... 6
- Flexible, with end sleeve		mm ²	1.5 ... 35	1.5 ... 6
• Conductor cross-sections for S0 pulse outputs				
- Rigid		mm ²	0.14 ... 2.5	0.14 ... 2.5
- Flexible, with end sleeve		mm ²	0.14 ... 1.5	0.14 ... 1.5
Ambient conditions				
• Mechanical environment			M1	
• Electromagnetic environment			E2	
• operating temperature		°C	-10 ... +55	
• Temperature limits for storage and transport		°C	-25 ... +70	
• Relative humidity (without condensation)		%	≤ 80	
• Vibrations	Sinus amplitude at 50 Hz	mm	± 0.075	
• Degree of protection	Installed device		IP51 ¹⁾ /IP20	
	Front side/terminals			

1) For installation in a distribution board with at least IP51 degree of protection.

PAC1500 three-phase counters, 7KT1 5

Dimensional drawings

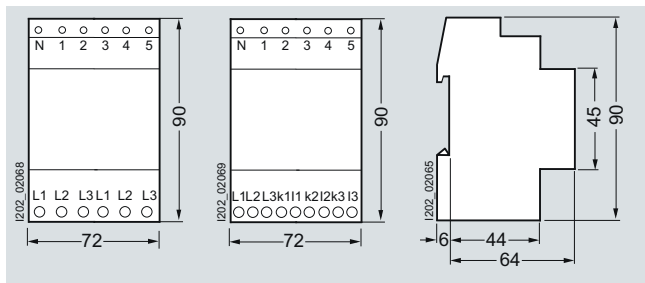

7KT1 543
7KT1 545

7KT1 540

Schematics

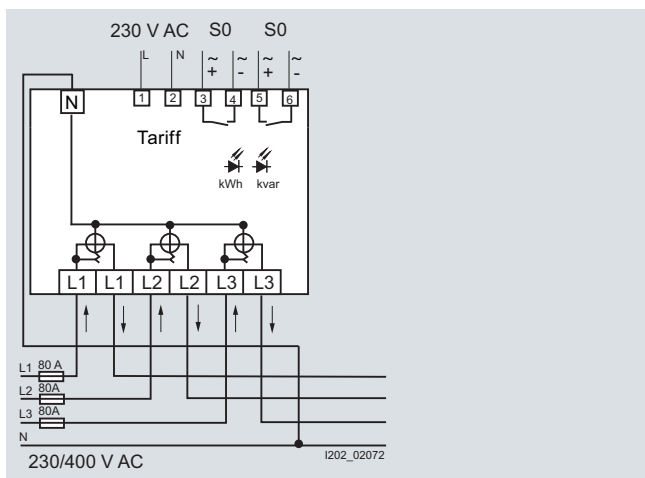

7KT1 543, 7KT1 545, three-phase connection

To achieve the specified accuracy, the N conductor must be connected to the counter.

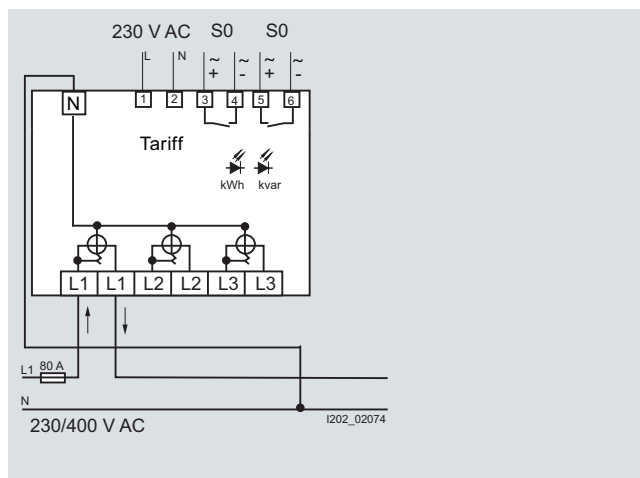

7KT1 543, 7KT1 545, single-phase connection

With single-phase connection the display lighting cannot be activated.

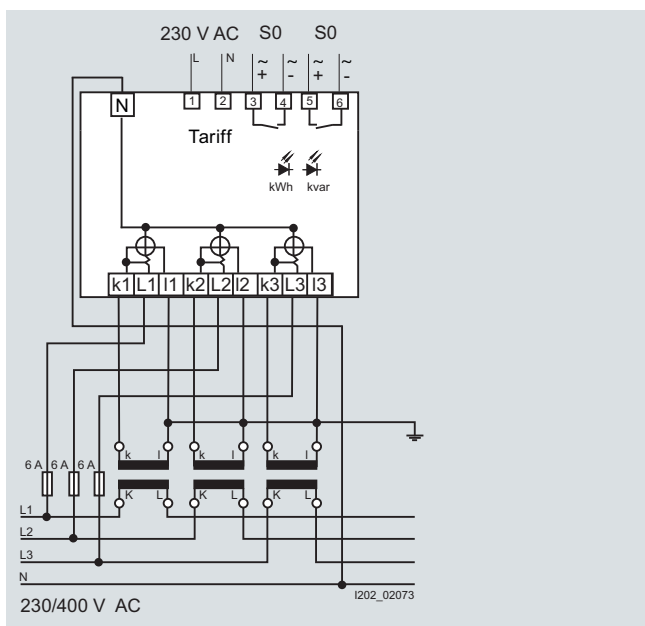

7KT1 540

Measuring Devices and E-counters

E-counters

PAC1500 three-phase counters, 7KT1 5

More information

Illustration of the display

- Green, backlit LCD
- The control button is used to select the different display levels.

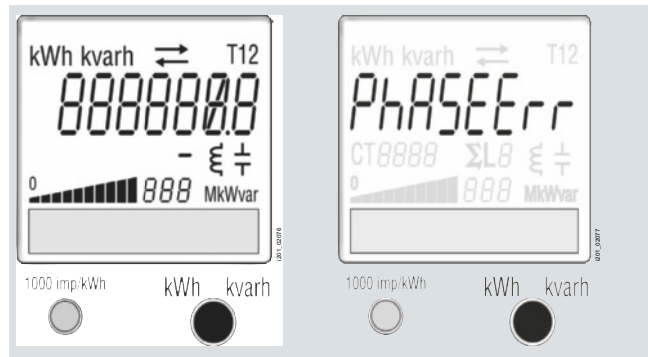

kWh	kWh indicator
Kvarh	kvarh indicator
↔	Power import indicator Power export indicator
T12	Selected / active tariff
LB	Phase value of energy display (L1-2-3) and SL
ΣL	Phase total of energy display
⌚	Indicator for inductive power
⌚	Indicator for capacitive power
BBB	Indicator for active and reactive power
CTBBB	Indicator for the current transformer ratio, primary side
▬▬▬▬	Bar diagram (in percent of I_{max})
⌚	Device name and approval data
○	LED accuracy check indicator
●	Control button

Operation

The large number of measured quantities makes it necessary to present the data in 2 display levels:

- Default and
- E-counter states

A) Default display level

- The default display level shows the sum of the active and reactive energy:
 - Sum of active energy (E1-E2+E5-E6)
 - Sum of reactive energy (E3-E4+E7-E8)
 - Software version
 - Checksum
- The various measured quantities can be called up with a brief press of the control button.
- A 3-digit display indicates the instantaneous power. A bar display indicates the instantaneous current in steps of 10 % in relation to the maximum load rating (I_{max}) (transformer connection in relation to $I_{secondary}$). The bar display is updated every 2 s.
- Note:
In this display level the symbol indicator (import/export) refers to the current power and not to the energy consumption value.

Display test control button

- If the control button is pressed and held for longer than 10 s, a display test will be activated.
- This test takes 30 s to complete. The DEFAULT display level then appears.

B) E-counter states display level

- This display level presents the energy values E1 to E8.
- To switch to the E1 to E8 energy values, press and hold the control button until the red LED lights up (approx. 4 s). The power indicators go out and the display shows the energy values E1-E8.
- A brief press of the control button enables these measured values to be shown in a loop.
- To return to the default display level, press and hold the control button for approx. 4 s or wait approx. 30 s for automatic switchover to the initial display.
- To view all the energy registers per phase (active and reactive energy for absorbed and generated energy for T1 and T2) in a loop, press the control button for 2 s.
- The display lighting is switched off automatically after 40 s of inactivity.

Resetting all energy registers

- If the control button is pressed and held for longer than 20 s, the word "rESEt" will appear.
- After the control button is pressed again for at least another 4 seconds, all the energy registers are set to ZERO.

Overview



PAC1500 single-phase E-counters:
left: Digital 7KT1 53 e-counter
right: E-counters for active energy 7KT1 140

The E-counters (power meters) are used to record the amount of electrical energy exported or imported. Siemens compact E-counters are designed as modular devices for alternating current and can be mounted on standard mounting rails. They comply with the counter standard EN 50470 (Part 1 and 3) and come with an LCD display.

The PAC1500 single-phase counters for direct connection are available up to 80 A. They store both active and reactive energy and all comply with accuracy class 1 (for active energy).

All E-counters have a pulse output (S0) and are designed for 1-tariff or 2-tariff measurements depending on the version. The calibrated versions are in accordance with the new Measuring Instruments Directive 2004/22/EC (MID).

At the same time the E-counters – except version 7KT1 140 – have an integrated optical interface (IrDA) for connecting communication modules. Integration of the E-counters, e.g. in energy management systems, is thus possible.

Technical specifications

PAC1500 single-phase counters, direct connection up to 80 A			7KT1 530	7KT1 531 7KT1 533	7KT1 140
Standards			EN 50470-1, EN 50470-3, EN 62053-23, EN 62053-31		
General data					
• Enclosures	Acc. to DIN 43880	MW	2		
• Mounting	Acc. to EN 60715		35 mm		
• Mounting height		mm	70		
Function					
• Operating mode	Single-phase loads	Conductors	2		
• Storage of setting and counter reading	Through (EEPROM)		Yes		--
• Rate	for active energy		T1	T1 + T2	T1
	For reactive energy		T1	T1 + T2	--
Supply (through measuring terminals)					
• Rated control supply voltage U_n		V AC	230		
• Voltage range		V	184 ... 276		
• Rated frequency f_n		Hz	50		
• Rated power dissipation P_V		VA (W)	≤ 8 (0.6)		
Overload capability					
• Voltage U_{max}	Continuous operation	V	276		
	Short-time operation (for 1 s)	V	300		
• Current I_{max}	Continuous operation	A	80		
	Short-time operation (for 10 ms)	A	2400		
Display					
• Display mode			LCD		Electromechanical
• Digits			7 (1 decimal point)		
• Display dimensions		mm x mm	6 x 3		3.8 x 1.5
• Active energy: 1 display, 7-digit + display import or export (arrow)	Tariff/tariffs	kWh	000000.0 ... 999999.9		
	Max display (continuous)	kWh	999999.9 ... 000000.0		
• Reactive energy: 1 display, 7-digit + display import or export (arrow)	Tariff/tariffs	kvarh	000000.0 ... 999999.9		--
	Max display (continuous)	kvarh	999999.9 ... 000000.0		
• Instantaneous active power: 1 display, 3-digit		W, kW, MW	000 ... 999		
• Instantaneous reactive power: 1 display, 3-digit		var, kvar, Mvar	000 ... 999		
			--		
• Current tariff					
	1 display, 1-digit		T1	T1/T2	T1
• Display period		s	1	1	--
Measuring accuracy at 23 ±1 °C					
• Active energy and active power	Acc. to EN 50470-3	%	±1 (B)		
• Reactive energy and reactive power	Acc. to EN 62053-23	%	±2		--

Measuring Devices and E-counters

E-counters

PAC1500 single-phase counters, 7KT1 14, 7KT1 53

PAC1500 single-phase counters, direct connection up to 80 A				7KT1 530	7KT1 531 7KT1 533	7KT1 140
Measuring inputs						
• Connection type	Phase/N			Direct		
• Operating range voltage	Phase/N	V AC		184 ... 276		
• Current I_{ref}		A		15		
• Current I_{min}		A		0.75		
• Operating range current ($I_{st} ... I_{max}$)	Direct connection	A		0.0025 ... 80		
• Frequency		Hz		50		
• Current waveform				Symmetrical sinusoidal		
• Operational starting current I_{st}		mA		25		
S0 interface Acc. to EN 62053-31						
• Pulse outputs - For absorbed active and reactive energy				Yes		Yes, only for active energy
• Pulse count		Pulses/kWh		1000		
• Pulse duration		ms		30 ± 5		30 ± 2
• Required voltage		V AC V DC		5 ... 230 ± 5 % 5 ... 300		
• Permissible current (pulse on)		mA		90		
• Permissible current (pulse off, maximum fault current)		µA		1		
Optical interfaces						
• Calibration from the front (accuracy check)	LED	Pulses/kWh		1000		
IR interface						
• At the side for connecting communication modules (M-Bus / Modbus RTU / RS 485 / KNX)				--	Yes	--
Safety Acc. to EN 50470-1						
• For indoor areas				Yes		
• Overvoltage category				4		
• Operational voltage		V		300		
• Test voltage	1.2/50 µs	kV		6		
• Flame resistance	UL 94	Class		V0		
Terminal connections						
• Lift terminals of main current paths	Screw head Z ± Pozidriv			PZ2		
• Lift terminals for S0 pulse outputs	Blade for slotted screw	mm x mm		0.8 x 3.5		
• Conductor cross-sections of operational current and main current paths	Rigid	mm ²		1.5 ... 35		
	Flexible, with end sleeve	mm ²		1.5 ... 35		
• Conductor cross-sections for S0 pulse outputs	Rigid	mm ²		0.14 ... 2.5		
	Flexible, with end sleeve	mm ²		0.14 ... 2.5		
Ambient conditions						
• Mechanical environment				M1		
• Electromagnetic environment				E2		
• operating temperature		°C		-10 ... +55		
• Temperature limits for storage and transport		°C		-25 ... +70		
• Relative humidity (without condensation)		%		≤ 80		
• Vibrations	Sinus amplitude at 50 Hz	mm		± 0.075		
• Degree of protection	Installed device Front side/terminals			IP51 ¹⁾ /IP20		

¹⁾ For installation in a distribution board with at least IP51 degree of protection.

Dimensional drawings

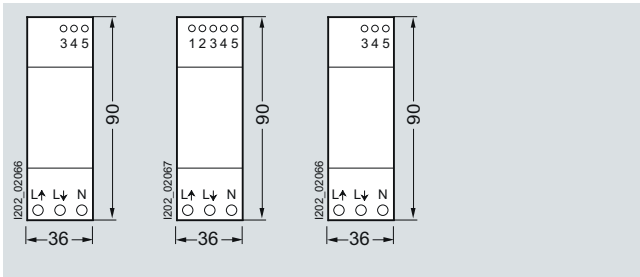

7KT1 530

7KT1 531,
7KT1 533

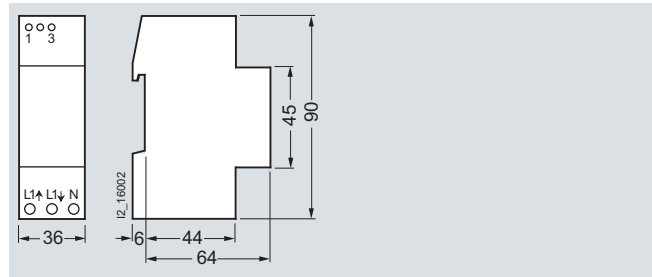

7KT1 140

Schematics

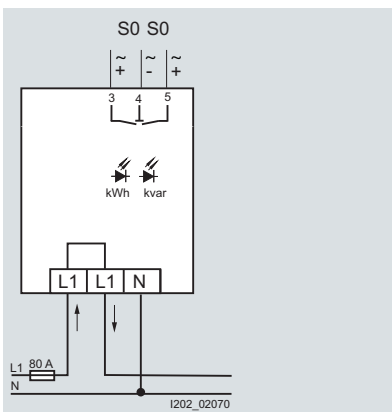

7KT1 530

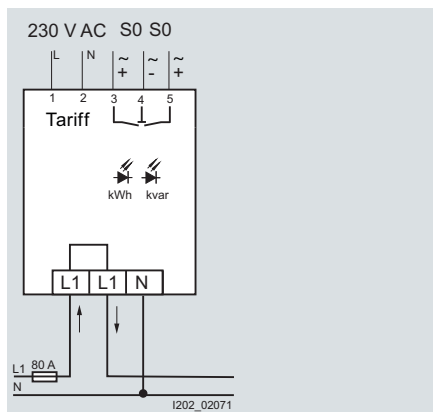

7KT1 531,
7KT1 533

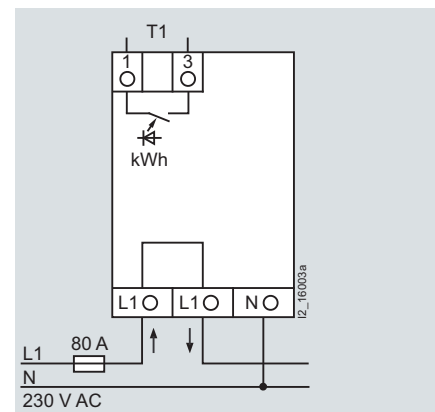

7KT1 140

Measuring Devices and E-counters

E-counters

PAC1500 single-phase counters, 7KT1 14, 7KT1 53

More information

Digital 7KT1 53. single-phase E-counters, illustration of display

- Green, backlit LCD
- The control button is used to select the different display levels.

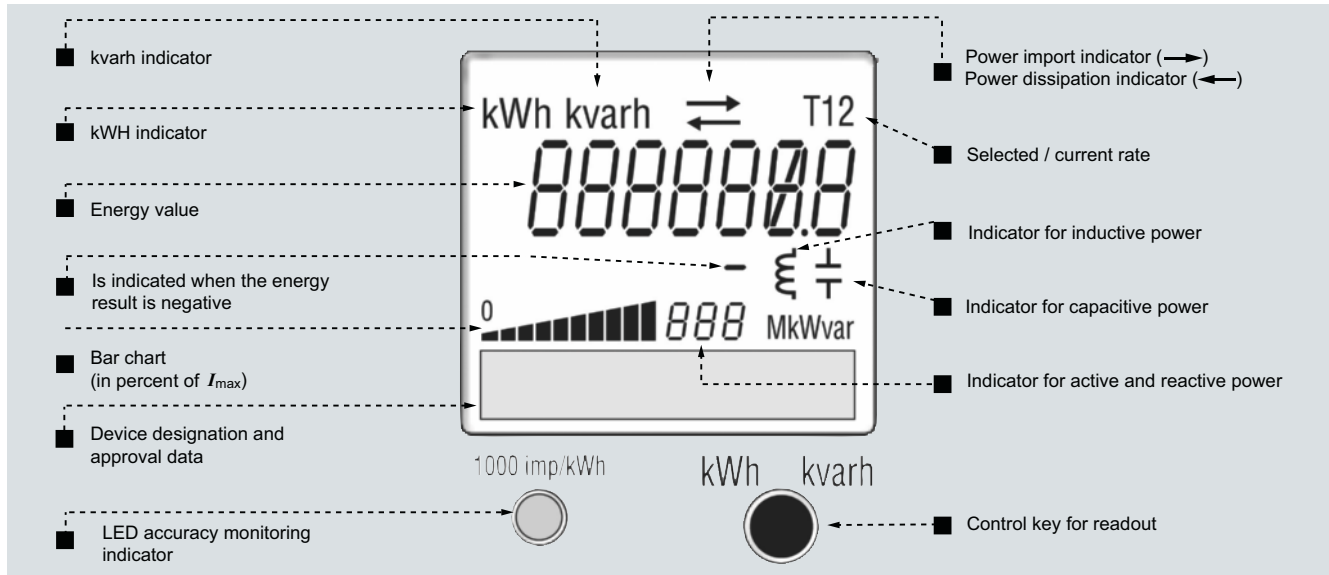

Operation

The large number of measured quantities makes it necessary to present the data in 2 display levels:

- Default
- E-counter states

A) Default display level

- The default display level shows the sum of the active and reactive energy:
 - Sum of active energy (E1-E2 for 7KT1 530 and E1-E2+E5-E6 for 7KT1 531, 7KT1 533)
 - Sum of reactive energy (E3-E4 for 7KT1 530 and E3-E4+E7-E8 for 7KT1 531, 7KT1 533)
 - Software version
 - Checksum
- The various measured quantities can be called up with a brief press of the control button.
- A 3-digit display indicates the instantaneous power. A bar display indicates the instantaneous current in steps of 10 % in relation to the maximum load rating (I_{max}). The bar display is updated every 1 second.
- Note:

In this display level the symbol indicator (import/export) refers to the current power and not to the energy consumption value.

Display test control button

If the control button is pressed and held for longer than 10 s, a display test will be activated.

This test takes 30 s to complete. The DEFAULT display level then appears.

B) E-counter states display level

- This display level presents the energy values E1 to E8.
- To switch to this display level, press and hold the control button until the red LED lights up (approx. 4s). The power indicators disappear and the display shows the energy values E1-E8.
- A brief press of the control button enables the loop display of these measured values.
- To return to the default display level, press and hold the control button for 4 seconds.
- The display lighting is switched off automatically after 40 s of inactivity.

Resetting of all energy registers (except for 7KT1 533)

If the control button is pressed and held for longer than 20 s, the word "rESET" will appear.

Pressing the control button again for at least another 4 seconds, resets all the energy registers to ZERO.

Measuring Devices and E-counters

Power monitoring devices

PAC3000 multimeters, 7KT1 30

Overview



PAC3000 multimeters

Multimeters are mainly used in power distribution boards for infeeds into buildings and plants. They replace the more common analog voltmeters and ammeters with measuring point changeover, as well as measuring devices for power outputs and power factor p.f..

The standard measured quantity to be indicated in the 5 display fields of the multimeter can be tailored to customer requirements. Versions for direct connection (63 A) or for transformers (/5 A) with adjustable transformer primary current from 5 A to 5000 A, enable a wide range of application.

The green 7-segment displays for the measured values and the orange indicators of the units of measurement directly alongside the measured values make for easy reading.

Technical specifications

PAC3000 multimeters		7KT1 300	7KT1 301
Standards		DIN 43751-1, DIN 43751-2 and EN 61010-1	
Supply			
• Rated control supply voltage U_c		V AC	230
• Primary operating range		$\times U_c$	0.8 ... 1.2
• Rated frequency		Hz	50
• Frequency ranges		Hz	45 ... 65
• Rated power dissipation P_V		VA	≤ 10
Overload capability			
• Voltage	Continuous: Phase/phase	V	480
	1 second: Phase/phase	V	800
	Continuous: Phase/N	V	276
	1 second: Phase/N	V	460
• Current	Continuous	A	76
	0.5 s	A	--
	10 ms	A	1000
Measuring inputs			
• Connection type			Direct
• Voltage U_e	Phase/phase	V	400
	Phase/N	V	230
• Operating range voltage	Phase/phase	V	87 ... 400
	Phase/N	V	50 ... 230
• Current I_e		A	63
• Operating range current		A	0.1 ... 63
• Transformer current	Primary current of the transformer	A	--
	Smallest input step	A	--
• Frequency		Hz	50
• Frequency ranges		Hz	45 ... 65
Display			
• Connection errors	Inverted phases		Err
• Voltage: 3 displays, 3-digit	Delta L1 – L2, L2 – L3, L3 – L1	V	87 ... 480
	Star L1/N – L2/N – L3/N	V	50 ... 276
	Voltage > 480/276 V		H H H
	Voltage < 87/50 V		---
• Current: 3 displays, 3-digit	L1 – L2 – L3		0.3 ... 76 A
	For current > 76 A or 6 A \times transformer conversion ratio		H H H
	For current < 0.1 A or 0.01 A \times transformer conversion ratio		O O O
• Frequency: 1 display, 3-digit	Σ L	Hz	45.0 ... 65.0
• Active power: 3 displays, 3-digit or 1 display, 3 of 7 digits	L1 – L2 – L3, Σ L	W, kW or MW	0 ... 999
	display with floating decimal point		
• Reactive power: 1 display, 3-digit	Σ L, with capacitive or inductive indication; display with floating decimal point	var, kvar or Mvar	0 ... 999
• Apparent power: 3 displays, 3-digit or 1 display, 3-digit	L1 – L2 – L3, Σ L	W, kW or MW	0 ... 999
	display with floating decimal point		

Measuring Devices and E-counters

Power monitoring devices

PAC3000 multimeters, 7KT1 30

PAC3000 multimeters			7KT1 300	7KT1 301
• P.f.: 3 displays, 3-digit or 1 display, 3-digit	L1 – L2 – L3, ΣL display with floating decimal point		0.01 ... 1.00	
• Transformer primary current	Only if set	A	--	5 ... 5000
• Transformer secondary current	Only if set	A	--	5
• Display period		/s	2	
• Storage of setting			EEPROM	
Measuring accuracy				
• Voltage		%	2	
• Current		%	2	
• Power		%	4	
• P.f.		%	4	
• Frequency		%	2	
Safety according to EN 61010-1				
• Pollution degree			2	
• Overvoltage category			II	
• Operating voltage category		V	600	
• Clearances		mm	≥ 3.0	
• Creepage distances	In device	mm	≥ 4.3	
	On printed boards (not installed)	mm	≥ 3.0	
• Test pulse voltage	1.2/50 μs	kV	4	
• Test voltage	50 Hz, 1 min	kV	2.2	
Terminals				
• Main current paths	±screw (Pozidriv)		2	1
• Supply terminals	Blade for slotted screw	mm × mm	0.4 × 2.5	
• Conductor cross-sections, main current paths	Rigid, maximum	mm ²	1 × 25 or 2 × 16	1 × 6 or 2 × 4
	Rigid, minimum	mm ²	1 × 1.5	
• Conductor cross-sections for supply terminals	Rigid, maximum	mm ²	1 × 2.5 or 2 × 1.5	
	Flexible, with end sleeve, minimum	mm ²	1 × 0.75	
Ambient conditions				
• Temperatures		°C	0 ... +55	
• Relative humidity		%	≤ 80	
• Vibrations	Sinus amplitude at 50 Hz	mm	±0.25	
• Degree of protection	Acc. to EN 60529		IP20, with connected conductors	
• Safety class	Acc. to EN 61010-1		II	

Dimensional drawings

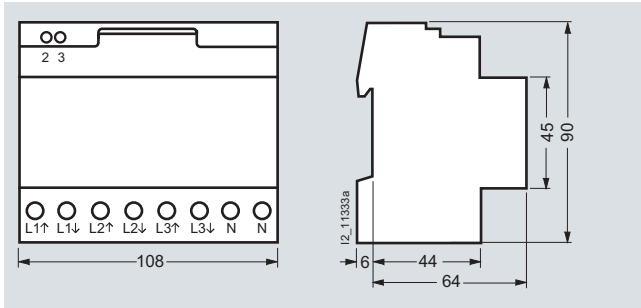

7KT1 300

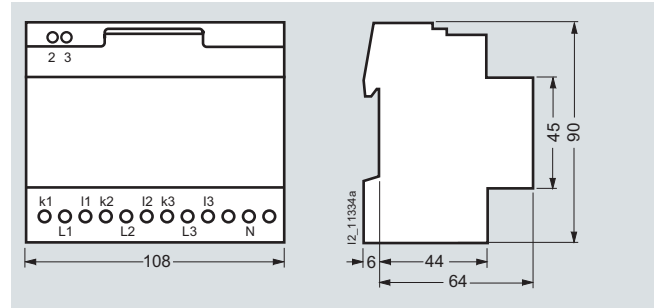

7KT1 301

Schematics

Instructions for the connection of transformer counters

In the case of cross-section reduction, a short-circuit resistant cable is required for the power supply of terminal 2, depending on the fusing for phases L1, L2, L3. A fuse of 6 A is recommended for line protection.

Current transformers must not be operated with open terminals as this can result in dangerously high voltages, which may cause personal injury and/or property damage. It can also lead to a thermal overload of the transformers.

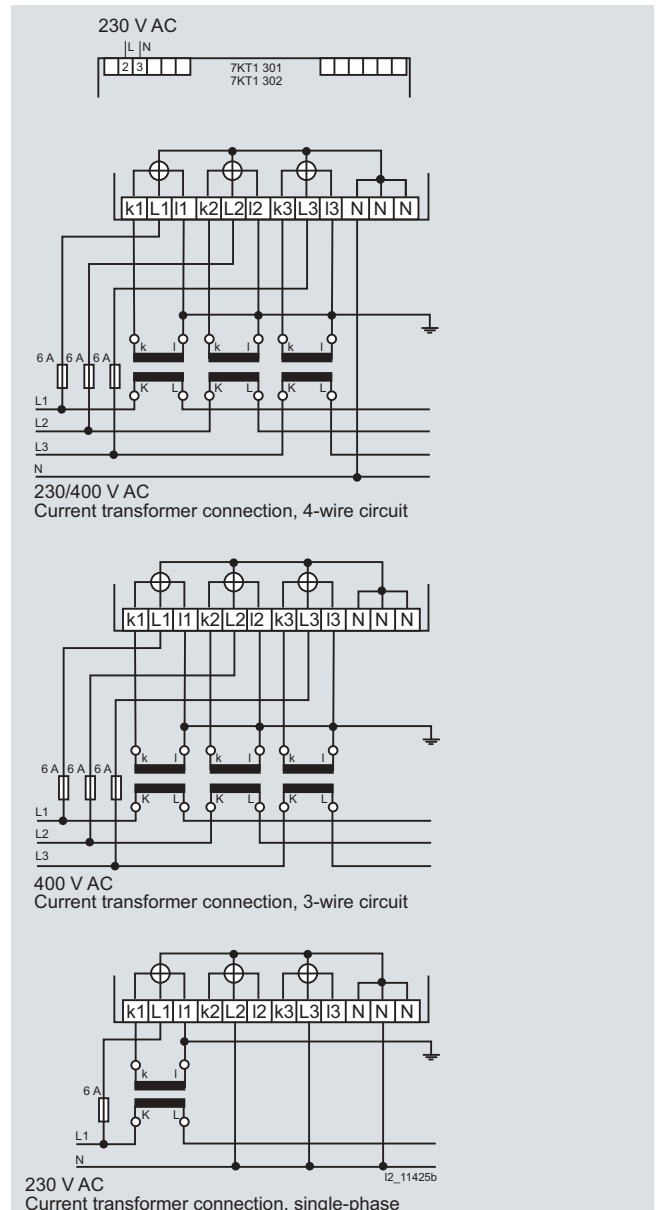
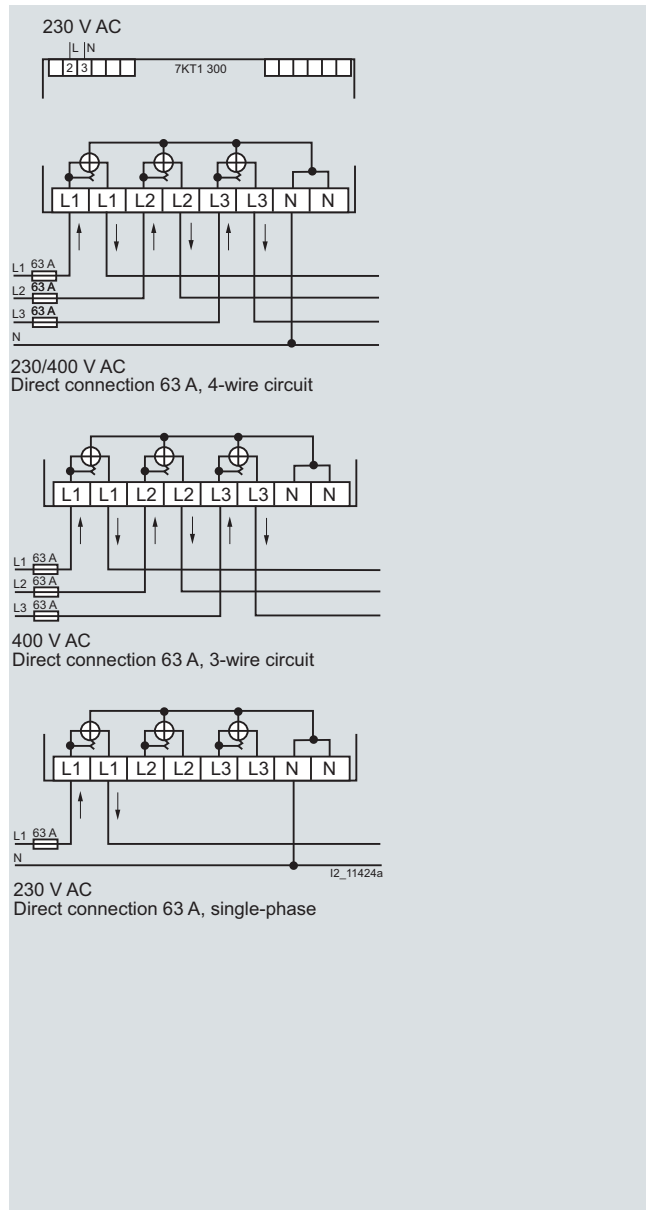

Measuring Devices and E-counters

Power monitoring devices

PAC3000 multimeters, 7KT1 30

More information

Voltage measurement

The multimeter measures the delta voltages L1 against L2; L2 against L3 and L3 against L1 or the star voltages L1, L2, L3 against N.

ΣL symbol for the three-phase system

This indicates that all physical units shown under this symbol are always 3-phase.

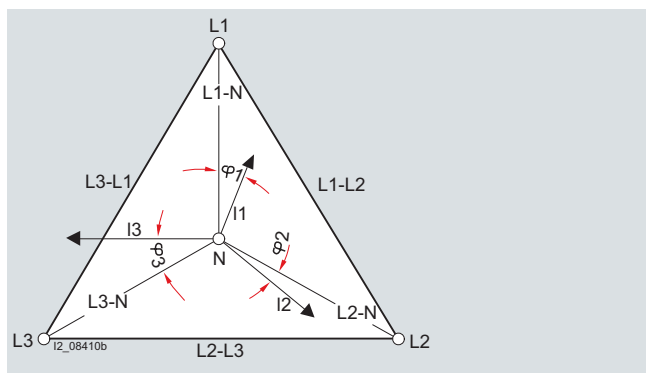

Readout data

You can continuously display 5 measured quantities from the following 23 options.

No.	Measured value	Display	Unit	Assignment
1	Active power	D1	W	L1
2	Voltage	D1	V	L1
3	Current	D1	A	L1
4	Apparent power	D1	VA	L1
5	P.f.	D1	P.f.	L1
6	Voltage	D1	V	L1 – L2
7	Active power	D2	W	L2
8	Voltage	D2	V	L2
9	Current	D2	A	L2
10	Apparent power	D2	VA	L2
11	P.f.	D2	P.f.	L2
12	Voltage	D2	V	L2 – L3
13	Active power	D3	W	L3
14	Voltage	D3	V	L3
15	Current	D3	A	L3
16	Apparent power	D3	VA	L3
17	P.f.	D3	P.f.	L3
18	Voltage	D3	V	L3 – L1
19	Active power	D1, D2, D3, D5	W	ΣL
20	Apparent power	D1, D2, D3, D5	VA	ΣL
21	Reactive power	D5	var	ΣL
22	Frequency	D4	Hz	ΣL
23	P.f.	D1, D2, D3, D4	P.f.	ΣL

2 set values are also indicated:

24	Transformer setting	D5	CT/A	/5
25	Transformer setting		CT/A	5 ... 5000

Displays

The multimeters have a covered, brightly lit LED display. The measured values are indicated on an 11-mm high, green, 7-segment LED, the physical units are indicated by orange text abbreviations. Both colors are easier to recognize than the red LEDs used for conventional displays. Capacitive loads are automatically indicated by a capacitor symbol, inductive loads by a coil symbol – also in orange.

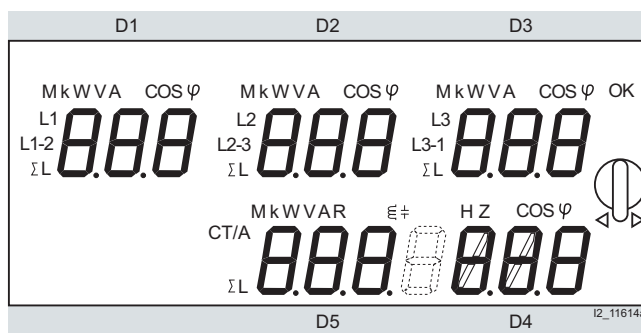

Matrix selection

Conventional measuring instruments display voltages, currents, powers, etc. in a rigid sequence on several "screens". These multimeters allow users to define their own standard for measured quantities per display field, so that they can be implemented far more universally and flexibly.

A special feature is the analysis of the different loads on the phases. Phase displacement and unsymmetrical or unbalanced loads can cause partial overloads. These multimeters offer a range of different options for combining and assessing measured values.

The display fields are selected using rotary pushbuttons and the desired indications confirmed with OK. By making the horizontal selection e.g. W V A or p.f., and the vertical selection, e. g. L1, L1–L2 or ΣL , users can then define the desired measured quantities for this display field.

The vertical data on the display can be assigned to any measured value in the horizontal data. The letters M(ega) and k(ilo) are automatically assigned according to measuring range, i.e. measured value, e.g. kW or MW. Capacitive loads are automatically indicated by a capacitor, inductive loads by a coil.

The following diagram shows an example of what your matrix selection might look like.

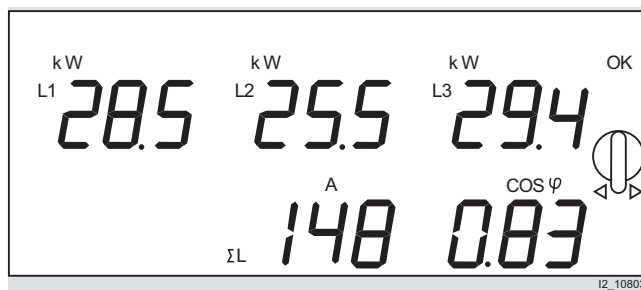

Measuring Devices and E-counters

Power monitoring devices

PAC3000 multiconverters, 7KT1 31, 7KT1 34

Overview



Multiconverter PAC3000

Multiconverters are mainly used in power distribution boards for infeeds into buildings and plants. They replace the more common analog voltmeters and ammeters with measuring point changeover, as well as measuring devices for power outputs and power factor p.f.

The standard measured quantity to be indicated in the 6 display fields of the PAC3000 multiconverter can be tailored to customer requirements. The measured values of all measured quantities can also be displayed quickly and easily over the operator buttons. Versions for direct connection (63 A) or for transformers (/5 A) with adjustable transformer primary current from 5 to 5000 A, enable a wide range of application.

The green 7-segment displays for the measured values and the orange indicators of the units of measurement directly alongside the measured values make for easy reading.

Technical specifications

PAC3000 multiconverters without communication interface			7KT1 310	7KT1 311
PAC3000 multiconverters with RS 485 interface (Modbus RTU, for LAN couplers)			7KT1 340	7KT1 341
Standards			EN 61010-1, EN 62053-21, -23, -31	
Supply				
• Rated control supply voltage U_C		V AC	230	
• Primary operating range		$\times U_C$	0.8 ... 1.2	
• Rated frequency		Hz	50	
• Frequency ranges		Hz	45 ... 65	
• Rated power dissipation P_V		VA	≤ 10	
Overload capability				
• Voltage	Continuous: Phase/phase	V	480	
	1 second: Phase/phase	V	800	
	Continuous: Phase/N	V	276	
	1 second: Phase/N	V	460	
• Current	Continuous	A	76	6
	0.5 s	A	--	110
	10 ms	A	2000	--
Measuring inputs				
• Connection type			Direct	Transformers /5 A
• Voltage U_e	Phase/phase	V	400	
	Phase/N	V	230	
- Operating range voltage	Phase/phase	V	87 ... 480	
	Phase/N	V	50 ... 276	
• Current I_e		A	63	5
- Operating range current		A	0.3 ... 63	0.012 ... 5
• Transformer current	Primary current of the transformer	A	--	5 ... 5000
	Smallest input step	A	--	5
• Frequency		Hz	50	
- Operating frequency range		Hz	45 ... 65	
Display				
• Connection errors	Inverted phases		Err	
• Voltage: 3 displays, 3-digit	Delta L1 – L2, L2 – L3, L3 – L1	V AC	87 ... 480	
	Star L1/N – L2/N – L3/N	V AC	50 ... 276	
	Voltage > 480/276 V		HHH	
	Voltage < 87/50 V		LLL	
• Current:	L1 – L2 – L3 – N conductor		0.3 ... 76 A	0.1 A ... 1.2 kA or 0.1 ... 6 A \times transformer conversion ratio
	For current > 76 A or 6 A \times transformer conversion ratio		HHH	
	For current < 0.3 A or 0.012 A \times transformer conversion ratio		OOO	
• Frequency: 1 display, 3-digit	ΣL	Hz	45.0 ... 65.0	
• Active power: 3 displays, 3-digit	L1 – L2 – L3, display with floating decimal point	W, kW or MW	0 ... 999	
• Active power: 3 displays, 3-digit, 3 of 7 digits + display import or export	ΣL , display with floating decimal point	W, kW or MW	0 ... 999	

Measuring Devices and E-counters

Power monitoring devices

PAC3000 multiconounters, 7KT1 31, 7KT1 34

PAC3000 multiconounters without communication interface			7KT1 310	7KT1 311
PAC3000 multiconounters with RS 485 interface (Modbus RTU, for LAN couplers)			7KT1 340	7KT1 341
Standards			EN 61010-1, EN 62053-21, -23, -31	
• Reactive power: 1 display, 3 of 7 digits + capacitive or inductive load	ΣL , display with floating decimal point	var, kvar or Mvar	0 ... 999	
• Apparent power: 3 displays, 3-digit	$L1 - L2 - L3, \Sigma L$ display with floating decimal point	VA, kVA or MV	0 ... 999	
• Apparent power: 5 displays, 3-digit, adjustable	ΣL , display with floating decimal point	VA, kVA or MV	0 ... 999	
• Active energy: 1 display, 7-digit display import or export, + display rate 1 or 2	ΣL , display with floating decimal point	Wh, kWh or MW	0 ... 99999999 or 0 ... 999	
• Reactive energy: 1 display, 7-digit + capacitive or inductive load	ΣL , display with floating decimal point	varh, kvarh or Mvarh	0 ... 99999999 or 0 ... 999	
• Apparent energy: 5 displays, 3-digit, adjustable rate	ΣL , display with floating decimal point	VAh, kVAh or MVh	0 ... 99999999 or 0 ... 999	
• P.f.: 3 displays, 3-digit	$L1 - L2 - L3$, display with floating decimal point		0.01 ... 1.00	
• P.f.: 4 displays, 3-digit, adjustable	ΣL		0.01 ... 1.00	
• Transformer primary current	Only if set	A	--	5 ... 5000
• Transformer secondary current	Only if set	A	--	5
• Temperatures		°C	0 ... +99	
• Display period		/s	2	
• Storage of setting and energy values			EEPROM	
S0 interface			Class A	
• Terminal output	Acc. to IEC 62053-31			
	For direct connection 63 A, adjustable	Imp/kWh	10 – 1 – 0.1 – 0.01 – 0.001	--
	Depending on the transformer factor, adjustable	Imp/kWh	--	10 – 1 – 0.1 – 0.01 – 0.001
• Pulse duration		ms	125 ... 300	
• Minimum interval between 2 pulses		ms	300	
• Required voltage		V DC	5 ... 30	
• Current ON/OFF		mA	10 ... 27/0 ... 2	
Measuring accuracy				
• Voltage		%	1	
• Current		%	1	
• Power outputs		%	2	
• Active energy	Acc. to IEC 62053-21		Class 2	
• Reactive energy	Acc. to IEC 62053-23		Class 2	
• P.f.		%	2	
• Frequency		%	1	
Safety according to EN 61010-1				
• Pollution degree			2	
• Overvoltage category			II	
• Operating voltage category		V	600	
• Clearances		mm	≥ 3.0	
• Creepage distances	In device	mm	≥ 4.3	
	On printed boards (not installed)	mm	≥ 3.0	
• Test pulse voltage	1.2/50 μs	kV	4	
• Test voltage	50 Hz, 1 min	kV	2.2	
Terminals				
• Main current paths	±screw (Pozidriv)		2	1
• Supply and control terminals	Blade for slotted screw	mm × mm	0.4 × 2.5	
• Conductor cross-sections, main current paths	Rigid, maximum	mm ²	1 × 25 or 2 × 16	1 × 6 or 2 × 4
	Rigid, minimum	mm ²	1 × 1.5	
• Conductor cross-sections Supply and control terminals	Rigid, maximum	mm ²	1 × 6 or 2 × 4	
	Flexible, with end sleeve, minimum	mm ²	1 × 0.75	
Ambient conditions				
• Temperatures		°C	0 ... +55	
• Relative humidity		%	≤ 80	
• Vibrations	Sinus amplitude at 50 Hz	mm	±0.25	
• Degree of protection	Acc. to EN 60529		IP20, with connected conductors	
• Safety class	Acc. to EN 61010-1		II	

Dimensional drawings

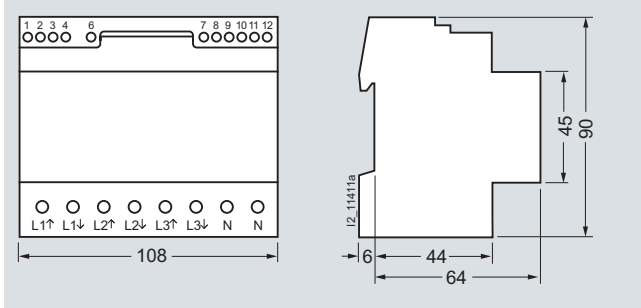

7KT1 3.0

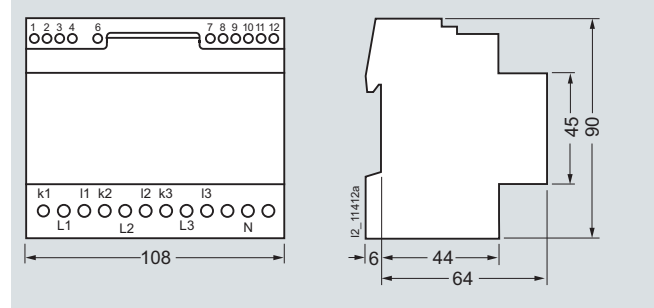

7KT1 3.1

Schematics

S0 interface

The S0 interface is a current interface for pulse transmission between a counter with integral pulse generator device and tariff rate device.

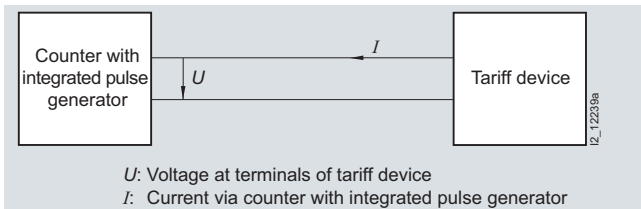

The tariff rate device is connected to the S0 interface of the counter over a 2-wire conductor and - acting as a passive electrical two-pole - supplies the pulse generator with a direct voltage.

The following diagram shows the dependency of the current path on the time according to DIN 43864.

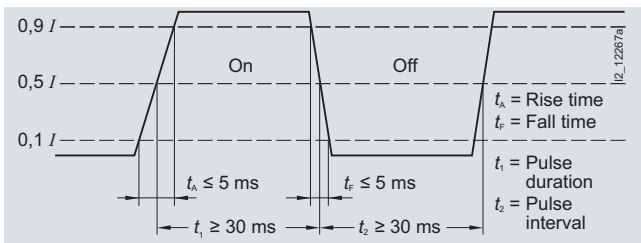

The following diagram shows the pulse output (S0 interface) for a 2-tariff counter: e.g. rate 1 → normal rate, rate 2 → special rate.

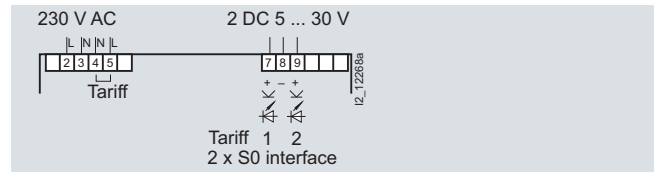

For pulse recording with devices from other manufacturers (pulse counters or digital inputs), a voltage within the range of 5 to 30 V DC must be applied to the output terminals of the S0 interface. The optocoupler operates as the switch. In order to prevent overloading, the current must not exceed a max. of 20 mA.

Grounding terminal

The interpolation point grounding terminals required for transmission technology only serve to shield the transmission cables and do not have a protective function.

Instructions for the connection of transformer counters

In the case of cross-section reduction, a short-circuit resistant cable is required for the power supply of terminals 2, 5 and 8, depending on the fusing for phases L1, L2, L3. A fuse of 6 A is recommended for line protection.

Current transformers must not be operated with open terminals as this can result in dangerously high voltages, which may cause personal injury and/or property damage. It can also lead to a thermal overload of the transformers.

Measuring Devices and E-counters

Power monitoring devices

PAC3000 multimeters, 7KT1 31, 7KT1 34

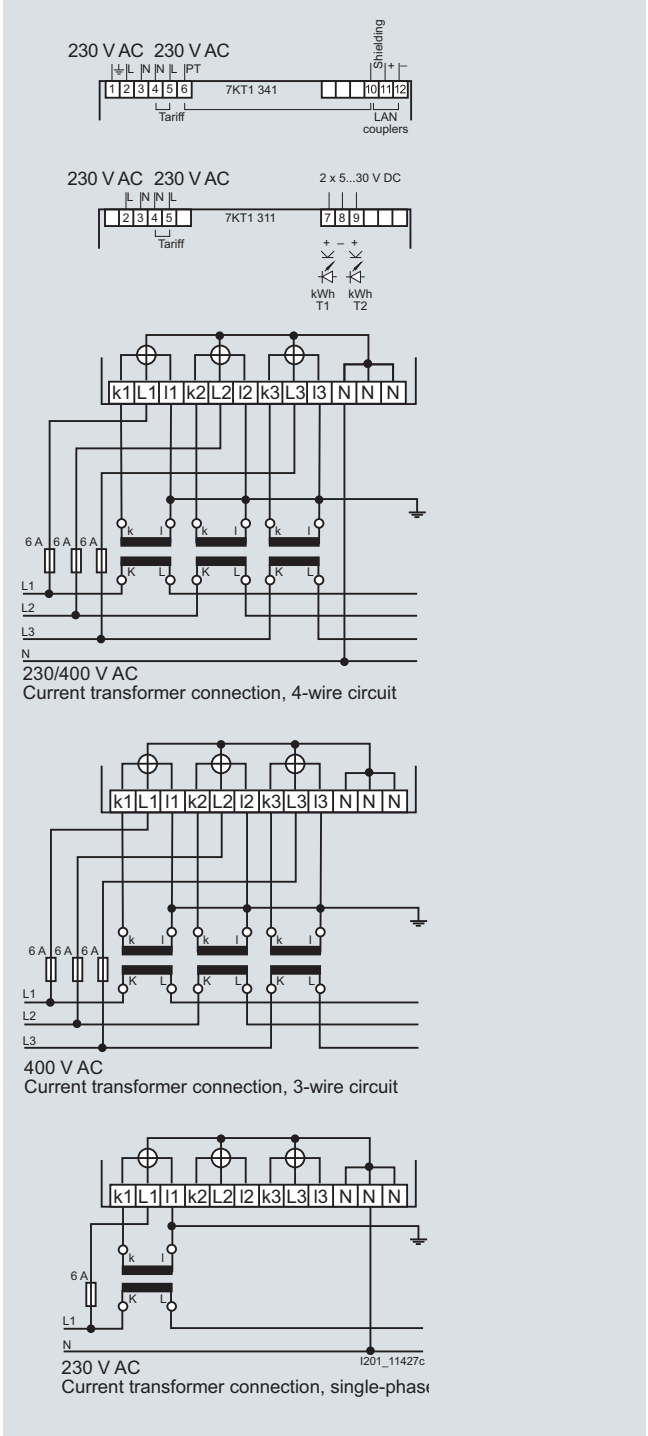
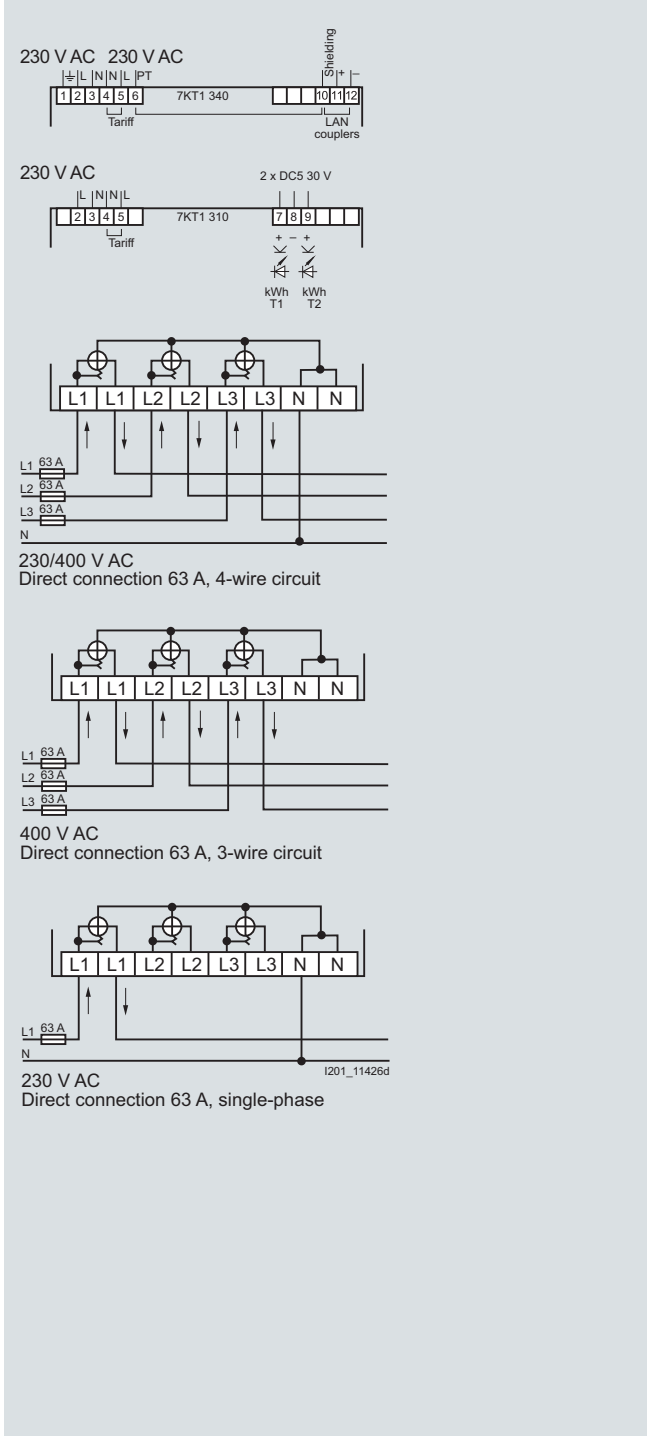

More information

Communication interfaces

Multiconounters with Modbus interface

The Modbus RTU is a very common communications solution. It is a serial, asynchronous form of communication, which requires RS 485 networks as the hardware platform. RS 485 networks can be set up with 2-wire copper or optical fiber cables and, compared to the RS 232 serial interface, offer fast transmission rates.

In a Modbus network, each bus station has a bus address within the range from 1 to 255. All stations within a network must be set to the same transmission rate. We recommend transmission rates of 9600 or 19200 bit/s. The address and transmission rate can be set in the user menu of the multiconounters.

In order to customize a Modbus installation, it is necessary to implement the appropriate software application for the master. This requires specific information about communication with multiconounters. For more information please visit us on the Internet at: www.siemens.com/beta

Multiconounters with LAN coupler on LAN

The 7KT1 391 LAN couplers support connection of up to thirty 7KT1 34 multiconounters to a LAN network. The LAN server and the multiconounters are interlinked over an RS 485 network. Setting the bus address in the 7KT1 34 multiconounters to "0" specifies that it is operating in "LAN" mode.

More information about LAN operation can be found at 7KT1 391. LAN couplers.

Voltage measurement

Depending on the selected connection type, the multiconcounter measures the delta voltages L1 against L2; L2 against L3 and L3 against L1 or the star voltages L1, L2, L3 against N.

ΣL symbol for the 3-phase system

This indicates that all physical units shown under this symbol are always 3-phase.

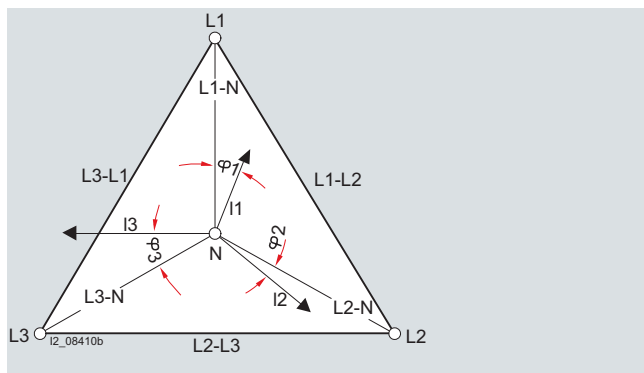

Temperatures

The temperature information of the multiconcounter is not suitable for an exact measurement of the ambient temperature. The device does not have a temperature sensor. It is also not possible to connect an external temperature sensor.

The temperature information merely enables a rough estimate of the temperature conditions in the device interior and immediate vicinity.

Readout data

You can continuously display 6 measured quantities from the following 35 options.

No.	Measured value	Display	Unit	Assignment
1	Active power	D1	W	L1
2	Voltage	D1	V	L1
3	Current	D1	A	L1
4	Apparent power	D1	VA	L1
5	P.f.	D1	P.f.	L1
6	Voltage	D1	V	L1 – L2
7	Active power	D2	W	L2
8	Voltage	D2	V	L2
9	Current	D2	A	L2
10	Apparent power	D2	VA	L2
11	P.f.	D2	P.f.	L2
12	Voltage	D2	V	L2 – L3
13	Active power	D3	W	L3
14	Voltage	D3	V	L3
15	Current	D3	A	L3
16	Apparent power	D3	VA	L3
17	P.f.	D3	P.f.	L3
18	Voltage	D3	V	L3 – L1
19	Temperatures	D6	°C	–
20	Current, N conductor	D6	A	ΣL
21	Active power	D4	W	ΣL
22	Reactive power	D5	var	ΣL
23	Apparent power	D5	var	ΣL
24	Frequency	D6	Hz	ΣL
25	P.f.	D1, D2, D3, D6	P.f.	ΣL
26	Active energy rate 1	D4	Wh	$\Sigma L \rightarrow$
27	Active energy rate 2	D4	Wh	$\Sigma L \rightarrow$
28	Active energy rate 1	D4	Wh	$\Sigma L \leftarrow$
29	Active energy rate 2	D4	Wh	$\Sigma L \leftarrow$
30	Reactive energy rate 1	D5	varh	ΣL , ind.
31	Reactive energy rate 2	D5	varh	ΣL , ind.
32	Reactive energy rate 1	D5	varh	ΣL , chap.
33	Reactive energy rate 2	D5	varh	ΣL , chap.
34	Apparent energy rate 1	D5	VAh	ΣL
35	Apparent energy rate 2	D5	VAh	ΣL

2 set values are also indicated:

36	Transformer setting	D4	CT/A	/5
37	Transformer setting	D5	CT/A	5 ... 5000

All the measured values are transmitted via LAN.

Measuring Devices and E-counters

Power monitoring devices

PAC3000 multiconverters, 7KT1 31, 7KT1 34

Displays

The multiconverters have a covered, brightly lit LED display. The measured values are indicated on an 11-mm high, green, 7-segment LED, the physical units are indicated by orange text abbreviations. Both colors are easier to recognize than the red LEDs used for conventional displays. Capacitive loads are automatically indicated by a capacitor symbol, inductive loads by a coil symbol – also in orange.

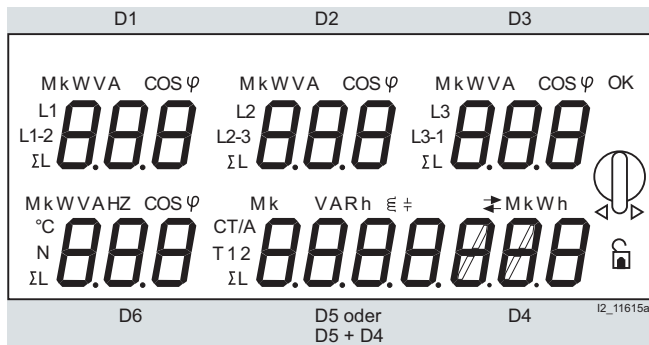

Matrix selection

Conventional measuring instruments display voltages, currents, powers, etc. in a rigid sequence on several "screens". These multiconverters allow users to define their own standard for measured quantities per display field, thus allowing more universal and flexible application.

A special feature is the analysis of the different loads on the phases. Phase displacement and unsymmetrical or unbalanced loads can cause partial overloads. In this case, the multiconverter offers a range of different options to combine measured values and assess them.

The display fields are selected using rotary pushbuttons and the desired indications confirmed with OK. By making the horizontal selection e.g. W V A or p.f., and the vertical selection, e. g. L1, L1-L2 or ΣL, users can then define the desired measured quantities for this display field.

The vertical data on the display can be assigned to any measured value in the horizontal data. The letters M(ega) and k(ilo) are automatically assigned according to measuring range, i.e. measured value, e.g. kW or MW. Capacitive loads are automatically indicated by a capacitor, inductive loads by a coil.

Overview



7KT 391 LAN couplers

A LAN coupler supports worldwide data recall from multi-counters and E-counters over a LAN link to the Internet.

Up to 30 devices can be linked with a LAN coupler. In turn, the LAN coupler is connected to a LAN.

Data communication between the LAN coupler and the PC takes place using the TCP/IP protocol.

Technical specifications

		7KT1 391	
Standards		IEE 802.3 AS, IEC 60950, EN 61000-6-2, EN 61000-6-3	
General data			
• Enclosures	Acc. to DIN 43880	4 modules	
• Mounting	Acc. to EN 60715	Mounting onto standard mounting rail (35 mm)	
• Mounting height		mm	70
Supply			
• Rated power dissipation P_v		VA	≤ 10
• Rated control supply voltage U_c		V AC	230
• Primary operating range		$\times U_c$	0.9 ... 1.10
• Rated frequency		Hz	50
• Frequency ranges		Hz	45 ... 65
Function			
• System start		Automatic upon switching on	
• LAN server identification		Over the IP address of the PC	
• Transmission rate	Limitation by LAN	Mbit/s	100
• Operating system		Windows XP/Vista/7	
• Operating system		IE 7/8; Mozilla Firefox 3.09 / 3.5.3 / 3.6; Opera 9.64 / 10 / 10.5; Safari 3.2.2 / 4.0.5; Google Chrome 3.0.195.27.	
LAN interface			
• HW interface		Connection RJ 45	
• SW interface		TCP/IP	
Interface to the measuring devices			
• HW interface	RS 485 terminals	Number	3 (+/-/shielded twisted pair)
• Line	Version		STP (shielded twisted pair)
	Minimum cross-section	mm ²	2 × 0.2 or 2 × AWG 24
	Maximum line capacity	pF/m	< 50
	Impedance	W	100
	Maximum overall cable length	m	≤ 1200
	Type of installation		Serial
Measuring devices can be connected directly		Number	30
Safety according to IEC 60950			
• Pollution degree			2
• Overvoltage category			III
• Operational voltage		V	300
• Enclosure material group			II
• Clearances		mm	≥ 4.0
• Creepage distances			≥ 4.5
• Test pulse voltage	1.2/50 μs 50 Hz, 1 min	kV	4
		kV	4
• Flame resistance	Acc. to UL 94	Class	V0
• Fire load		kJ	2977.8

Measuring Devices and E-counters

Power monitoring devices

LAN couplers, 7KT1 391

		7KT1 391	
Terminals			
• Lift terminals	±screw (Pozidriv)		PZ1
• Conductor cross-sections of main current paths	Rigid	mm ²	0.75 ... 6
	Flexible with sleeve	mm ²	0.75 ... 6
Environmental conditions			
• Temperatures	In operation	°C	-10 ... +55
	Storage and transport	°C	-25 ... +70
• Relative humidity	In operation	%	≤ 80
• Vibrations	Sinus amplitude at 50 Hz	mm	± 0.25
• Safety class	Acc. to IEC 60950		III
• Degree of protection	Installed device front side (terminals)		IP20

Dimensional drawings

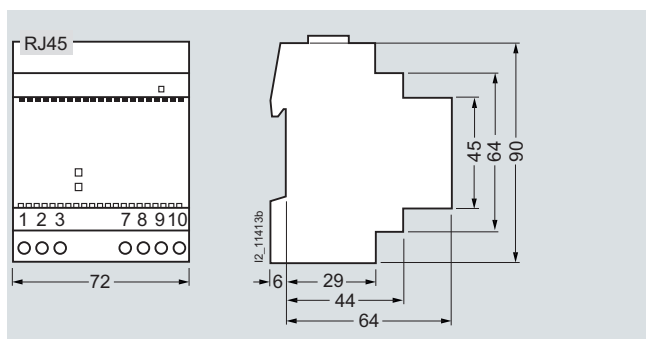

7KT1 391

Schematics

Diagram

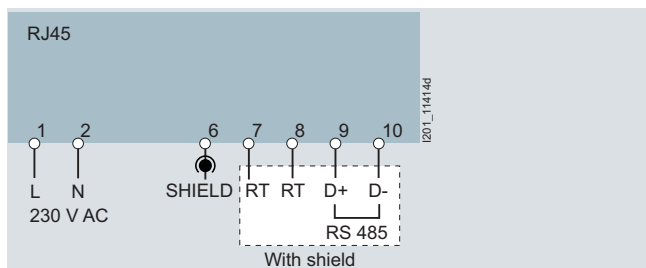

Connecting the devices to the LAN coupler

All the devices are connected in parallel with a shielded two-wire cable. Point-to-point installations, junctions or ring installations are not possible.

Grounding potential

Both the LAN cable with the RJ45 connector and the shielded cable of the RS 485 bus system must be grounded. This also applies to the devices connected to the LAN coupler.

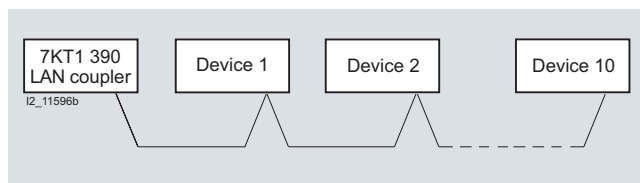

More information

Connection of the LAN coupler to a LAN

Each station in a LAN must be assigned its own IP address. On delivery, or after a reset, the LAN coupler has a standard IP address. The new IP address must be set in the LAN coupler during commissioning. This entails connecting the LAN coupler directly to a PC using a so-called "cross-over" cable. This direct connection can then be used to set a new IP address as well as other network parameters such as a subnet mask and a default gateway in the LAN coupler. The LAN coupler must then be connected to the target system as communication is subsequently only possible with the new settings.

Connection of measuring devices to the LAN coupler

E-counters and multiconverters are connected to the LAN coupler via their communication interface. The network is an RS 485 network in which devices are connected over a shielded two-wire cable. When using Modbus, the device address and transmission rate must be set in the multiconverters.

The LAN coupler carries out a so-called "polling" during runtime. This cyclically retrieves the most recently gathered measurement data from the measuring devices and buffers them in the LAN coupler. This can then be called up at any time over the LAN.

Data transmission from LAN coupler to PC

This data transmission is PC-controlled. The software tool LAN-Sync runs on the PC in the background.

More information can be found on the Internet at www.siemens.com/beta

Display of measurement data on the PC

The measurement data can be shown on the PC using a web browser.

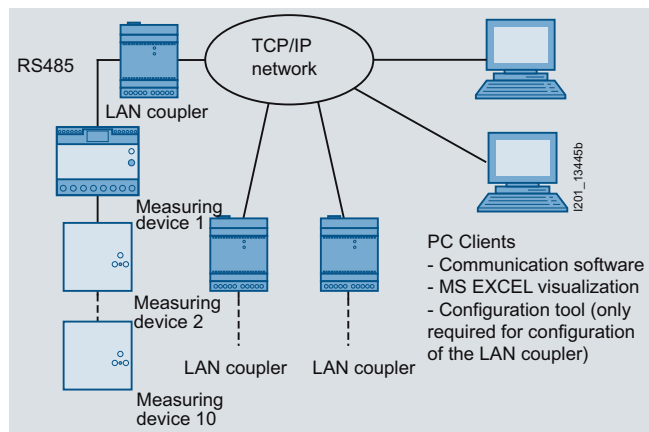

Block diagram of a system

Usable E-counters and multiconverters

Following E-counters and multiconverters can be connected to the LAN coupler:

	Order No.
Energy counters	
Digital 3-phase counters	
• PAC1500, for direct connection 80 A, double rate	7KT1 543
• PAC1500, for direct connection 80 A, double rate, calibrated version	7KT1 545
• PAC1500, for transformer connection .../5 A, double rate	7KT1 540
• For transformer connection .../5 A, double rate, calibrated version	7KT1 542
• For direct connection 125 A, double rate	7KT1 546
• For direct connection 125 A, double rate, calibrated version	7KT1 548
• For direct connection 63 A, double rate	7KT1 520
• For transformer connection .../5 A, double rate	7KT1 521
Digital 1-phase counters	
• PAC1500, for direct connection 80 A, double rate	7KT1 531
• PAC1500, for direct connection 80 A, double rate, calibrated version	7KT1 533
Multiconverters	
• PAC3000, for direct connection	7KT1 340
• PAC3000, for transformer connection .../5 A	7KT1 341
• For transformer connection .../5 A	7KT1 342

Measuring Devices and E-counters

Power monitoring devices

PAC3100, PAC3200 and PAC4200
power monitoring devices

Overview



Instrument variants		SENTRON	PAC3100	PAC3200	PAC4200
Functional overview					
Basic measurement variables					
Voltage, current			✓	✓	✓
Neutral conductor current			✓	--	✓
Apparent power, active power, reactive power, power factor			✓	✓	✓
Power factor of the fundamental wave			--	--	✓
Frequency	Of the reference phase		✓	✓	✓
Min/max values	Slave pointer function with date & time		✓ --	✓ --	✓ ✓
Power measurement					
Apparent energy			--	✓	✓
Active energy, reactive energy	Input Output Balance		✓ ✓ ✓	✓ ✓ --	✓ ✓ --
Number of tariffs	Apparent, active and reactive energy		1	2	2
Daily energy values for 365 days	Apparent, active and reactive energy		--	--	✓
Consumption recording of a sub-process or manufacturing process	Apparent, active and reactive energy		--	--	✓
Power averages of the last integration period	Active and reactive power average with min / max value		✓	✓	✓
Load profile record			--	--	✓ max. 3840 entries ¹⁾
E-counter for S ₀ signal at a digital input	Electrical energy any energy		-- --	✓ --	✓ ✓
Accuracy class for active energy	According to IEC 62053-21 / 62053-22		Class 1	Class 0.5S	Class 0.2S
Accuracy class for reactive energy	According to IEC 62053-23		Class 3	Class 2	Class 2
Monitoring of state of the plant and quality of the network					
Configurable displays	For presenting up to 4 measured quantities		--	--	4
Operating hours meter	Operating hours of loads		--	✓	✓
Sliding mean values	<i>U, I, S, P, Q, LF</i>		--	--	✓
THD voltage, current			--	THD-R	THD
Distortion current strength			--	--	✓
Phase angle, phase displacement angle			--	--	✓
Unbalance	Voltage current		--	$U_{nba} I_{nba}$ ²⁾	$U_{nb} I_{nb}$ ³⁾
Harmonics in voltage, current			--	--	3. to 31st
Limit value monitoring	Max. number of limit values		--	6	12
Boolean logic	For limit values inputs		-- --	✓ --	✓ ✓
Event memory for operation, control and system-related events	Including time stamp		--	--	✓ (> 4000 events)
Battery backup for min / max values			--	--	✓
System integration and communication					
Ethernet (integrated)			--	10 Mbit/s	10/100 Mbit/s
• Protocol	Modbus TCP		--	✓	✓
• Gateway	Ethernet <--> RS 485 (Modbus)		--	--	✓ ⁴⁾
PROFIBUS DP-V1			--	Expansion module optional	
RS 485			Integrated	Expansion module optional	
• Protocol	Modbus RTU		✓	✓	✓
4DI/2DO expansion module	Expansion to max. 10 DI / 6 DO		--	--	✓ (max. 2 modules)
Number of expansion modules	Max.		--	1	2
Integrated digital inputs (DI)	Number multifunctional		2 --	1 ✓	2 ✓
Integrated digital outputs (DO)	Number multifunctional		2 ✓	1 ✓	2 ✓
Installation plan					
Dimensions (L x W x D)	In mm		96 x 96 x 56	96 x 96 x 56	96 x 96 x 82
Mounting depth	PAC PAC with expansion module (in mm)		51 --	51 73	77 99
Panel cutout (L x W)	In mm		92 x 92	92 x 92	92 x 92
Standards and approvals					
CE / cULus / C-Tick / GOST			✓	✓	✓
IEC 61557-12			✓	--	✓

¹⁾ This corresponds for example to a duration of 40 days with a measurement period length of 15 minutes.

²⁾ U_{nba}, I_{nba} - Unbalance with regard to amplitude

³⁾ U_{nba}, I_{nba} - Unbalance with regard to amplitude and phase

⁴⁾ In conjunction with SENTRON PAC RS 485 expansion module

✓ = Available, -- = Not available

Measuring Devices and E-counters

Power monitoring devices

PAC3100, PAC3200 and PAC4200
power monitoring devices

Application

Three-phase power monitoring devices are used to measure and indicate all relevant network parameters of an electrical installation and they monitor these parameters permanently.

Applications

Wherever power has to be distributed, be it in industrial or infra-structural buildings, the SENTRON PAC supplies important information to the building services system or the power controlling system.

The many different communication options offered by the SENTRON PAC make it an indispensable supplier of data for power management systems and for plant and building automation.

Industries

Power distribution systems for the power supply are needed in all sectors of industry. SENTRON PAC is used accordingly in all sectors where power consumption and electrical parameters are to be measured.

Integration of PAC3200 and PAC4200

When the SENTRON PAC3200 and PAC4200 are fully integrated in a power management system, they monitor the power consumption and help to monitor the operating state of the plant. Measured values, limit value violations, operating hours of a connected load or power flows are supplied by the instruments quickly and reliably.

Using the optionally available interface modules, it is possible to integrate both instruments in every I&C system or every SIMATIC S7 environment.

System integration using function block libraries

Optionally available function block libraries make it easy to integrate the power monitoring devices in the SIMATIC PCS 7 process control system and the SCADA-System SIMATIC WinCC. Together with the faceplates as user interface for SENTRON PAC3200, the driver blocks and diagnostics blocks in the control system enable the operating and monitoring of technologically important values and functions of the measuring devices in the respective target system.

System integration of RS 485 field bus devices through Ethernet

A special feature is the integrated gateway function of the SENTRON PAC4200. It enables a cost-effective and simple connection of devices with an RS 485 interface to an Ethernet network.

Everything required is provided by the SENTRON PAC RS485 expansion module, to which a maximum of 31 lower-level devices can be connected without a repeater and as many as 247 with a repeater.

The gateway function of the SENTRON PAC4200 supports the Modbus protocol and can be parameterized using SENTRON powerconfig.

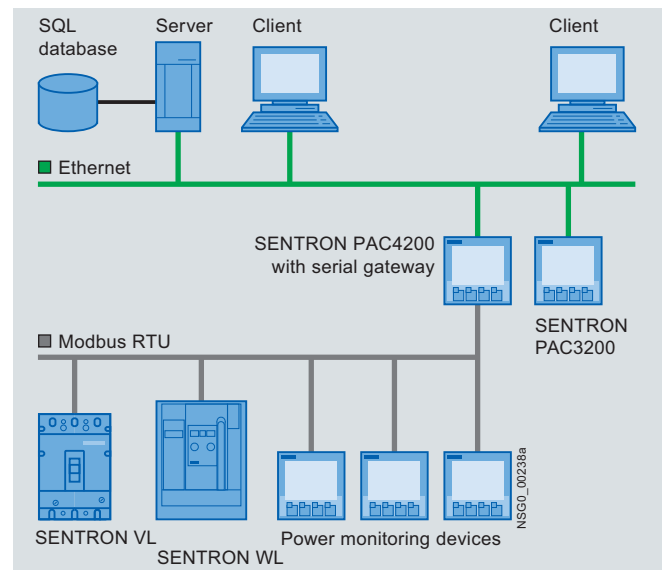

Connecting Modbus-RTU devices to a power management system through PAC4200

More information

Suitable current transformers can be found

- In the Industry Mall, section "Industry Automation and Drive Technologies"
 - > "Low-Voltage Power Distribution and Electrical Installation Technology"
 - > "Protection Equipment"
 - > "Molded Case Circuit Breakers"
 - > "SENTRON 3VL Molded-Case Circuit Breakers"
 - > "SENTRON 3VL Molded-Case Circuit Breakers up to 1600 A"
 - > "Accessories and Spare Parts"

Additional information about the devices and software components of the Power Management System can be found on the Internet at www.siemens.com/powermanagementsystem

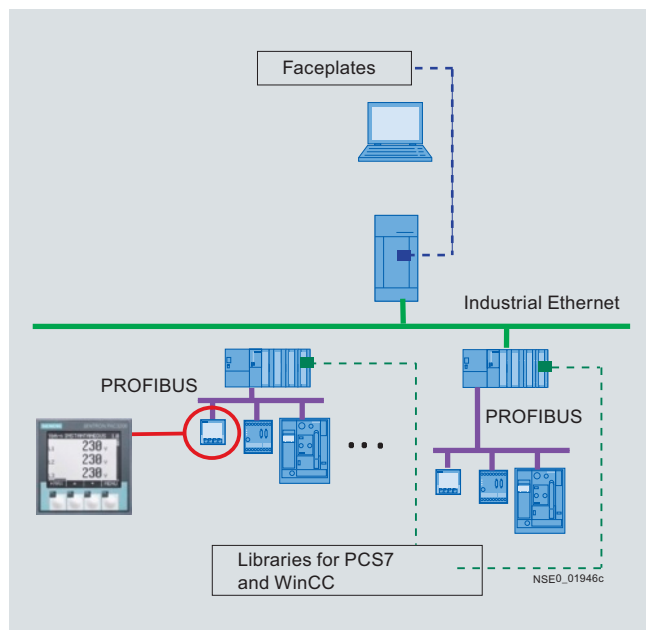

Integration of the SENTRON PAC3200 in SIMATIC PCS 7/WinCC

Measuring Devices and E-counters

Power monitoring devices

PAC PROFIBUS DP expansion modules

Overview



SENTRON PAC PROFIBUS DP expansion modules

The PAC PROFIBUS DP expansion module has the following features:

- Pluggable PROFIBUS DP communication modules for SENTRON PAC3200 and PAC4200 power monitoring devices
- Parameterizable from the front of the device or using parameterization software
- Using PROFIBUS DP-V1, data can be transferred in both cyclic and acyclic modes
- Easy engineering thanks to integration into SIMATIC STEP 7 and/or simple integration via GSD file for other programming systems
- Optimum use of a control system's process image for selection of individual measured values for cyclical transfer
- all baudrates from 9.6 kbit/s up to 12 Mbit/s are supported
- Connection through 9-pole Sub-D connector according to IEC 61158
- No external auxiliary power necessary
- Additional display via the device display and via LEDs on the module

Application

The SENTRON PAC PROFIBUS DP communication module is plugged onto the rear of the power monitoring device. The device identifies the module automatically and presents the parameters of relevance for this module for selection in the parameterization menu.

All individual measured values supplied by the SENTRON PAC power monitoring devices are selected and cyclically transmitted by means of the GSD file. This permits the optimum use of the PROFIBUS Master process image.

Measuring Devices and E-counters

Power monitoring devices

PAC RS485 expansion modules

Overview



SENTRON PAC RS485 expansion module

The SENTRON PAC RS485 expansion module has the following features:

- PAC RS485 plug-in communication module for SENTRON PAC3200 and PAC4200 power monitoring devices
- Parameterizable from the front of the device or using parameterization software
- Support for the Modbus RTU protocol
- Plug and play
- Baud rates 4.8 / 9.6 / 19.2 and 38.4 kbit/s are supported.
- Connection by means of 6-pole screw terminals
- No external auxiliary power necessary
- Status indication by LED on the module

Application

The SENTRON PAC RS485 communication module is plugged into the back of the PAC power monitoring device. The device identifies the module automatically and presents the parameters of relevance for this module for selection in the parameterization menu. The state of the module is indicated by the integrated LED.

In connection with the SENTRON PAC3200 and 4200 power monitoring devices, the Modbus RTU protocols are supported with baud rates of 4.8/9.6/19.2 and 38.4 kBd.

The SENTRON PAC RS485 expansion module is required for the gateway function of the PAC4200 to achieve simple devices with RS 485 interface, such as the PAC3100, via Ethernet (Modbus TCP).

Measuring Devices and E-counters

Power monitoring devices

PAC 4DI/2DO expansion modules for PAC4200

Overview



SENTRON PAC 4DI/2DO expansion modules

The SENTRON PAC 4DI/2DO expansion module is used to expand the SENTRON PAC4200 power monitoring device to up to 10 digital inputs and 6 digital outputs. It offers the following features:

- Up to two 4DI/2DO modules can be plugged onto a PAC4200.
- The 4DI/2DO modules mean that the internal digital inputs and outputs can be expanded by up to 8 inputs and 4 outputs.
- The 4DI/2DO expansion modules can be parameterized via the front of the device or via the SENTRON powerconfig configuration software.
- The digital inputs can be used without external voltage sources. They are self-powered.
- All functions of the integrated multifunctional inputs/outputs on the PAC4200 are also available in the 4DI/2DO expansion module.
- Inputs and outputs can be used as an S0 interface conforming to IEC 62053-31.
- The connection is made via a 9-pole screw terminal.
- No external auxiliary power supply is required.

Application

There are many possible uses for the SENTRON PAC 4DI/2DO expansion module. Some of these include:

- Connection of up to 10 energy counters with pulse output (S0) for detecting the consumption of other energy-carriers e.g. gas, water or compressed-air consumption
- Integration of other media into energy management system
- Monitoring of multiple, single switches with auxiliary contacts via PAC4200
- Use of the digital outputs as pulse output for active and reactive energy
- Use of the digital outputs as outputs for switching operations and/or for time synchronization.

Overview

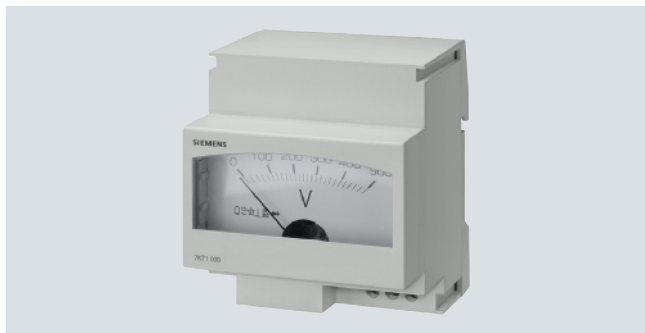

These devices for measuring voltages and currents can be used for monitoring incoming and outgoing currents or device currents in electric plants. They are suitable for direct connection in a single-phase system or with selector switches for the measured values in three-phase systems.

Technical specifications

		7KT1 000	7KT1 01.	7KT1 020
Standards		EN 60051-2		
Measuring ranges				
• Direct measurement	V AC	0 ... 500	--	--
	A AC	--	0 ... 25	--
	A AC	--	0 ... 40	--
	A AC	--	0 ... 60	--
	A AC	--	--	0 ... 150/5
• Transformer measurement	A AC	--	--	--
Max. permissible measuring frequency	Hz	45 ... 65		
Display		Pointer		
Measuring accuracy	At 23 ±1 °C	%	±1.5	±3
Rated operational power P_s		VA	< 2	< 1.1
Temperature influence		%/°C	±0.03	
Overload capability	Continuous		$1.2 \times U_{meas}$	$1.2 \times I_{meas}$
	Short-time for 1 s		$2 \times U_{meas}$	$10 \times I_{meas}$
Test voltage	50 Hz, 1 min	kV	> 2	
Terminals	±screw (Pozidriv)		1	2
Conductor cross-sections	Rigid, max.	mm ²	1 × 6/2 × 4	1 × 25/2 × 16
	Flexible, with end sleeve, min.	mm ²	0.75	1 × 6/2 × 4
Permissible ambient temperature		°C	-10 ... +55	
Degree of protection			IP20, with connected conductors	

Dimensional drawings

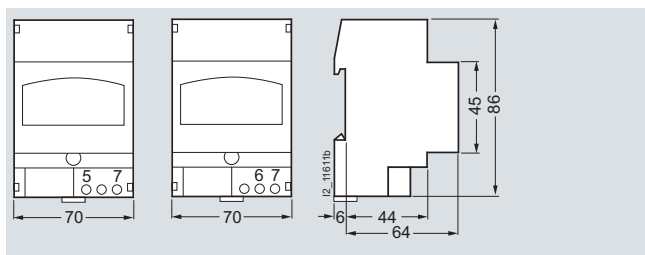

7KT1 000

7KT1 01., 7KT1 020

Schematics

Connections



7KT1 000

7KT1 01.,
7KT1 020

Measuring Devices and E-counters

Digital volt- and ammeters

7KT1 11, 7KT1 12 measuring devices

Overview



Measuring devices 7KT1: Left voltmeter, right ammeter

These devices for measuring voltages and currents can be used for monitoring incoming and outgoing currents or device currents in electric plants. They are suitable for direct connection in a single-phase system or with measuring transducers in three-phase systems.

The measuring ranges of the ammeter are set at the device with a coding switch.

Technical specifications

		7KT1 110	7KT1 120
Standards		DIN 43751-1, -2	
Rated control supply voltage U_c	V AC	230	
Primary operating range	$\times U_c$	0.9 ... 1.15	
Rated frequency	Hz	45 ... 65	
Rated operational power P_s	VA	< 2	
Measuring range			
• Voltage	Direct measurement	V AC	12 ... 600
• Current	Direct measurement	A AC	--
	Transformer measurement	A AC	0.4 ... 20 direct 0.1 ... 1000/5
Display			
• Voltage	> 600 V	H H H	
	< 12 V	-- -- --	
• Current	Direct > 20 A	--	
	Transformer > 5 A	H H H	
	Direct < 0.4 A	-- -- --	
	Transformer < 0.1 A	-- -- --	
Measuring cycle		/s	4 times
Measuring accuracy	At 23 °C	%	$\pm 0.5 \pm 1$ digit
Temperature influence		%/°C	± 0.03
Overload capability			
• Voltage	Continuous	V	720
	Short-time for 1 s	V	780
• Current	Continuous, direct	A	--
	Continuous, transformer	A	22
	Short-time for 1 s, direct	A	5.5
	Short-time for 1 s, transformer	A	200
		A	50
Electrical isolation			
• Clearances		mm	≥ 3
• Creepage distances in the device		mm	≥ 4.3
• Creepage distances on the printed board	Printed boards not installed	mm	≥ 3.0
Test voltage	50 Hz, 1 min	kV	2.2
Terminals	\pm screw (Pozidriv)		1
Conductor cross-sections	Rigid, max.	mm ²	1 × 6/2 × 4
	Flexible, with end sleeve, min.	mm ²	0.75
Permissible ambient temperature		°C	-10 ... +55
Degree of protection			IP20, with connected conductors

Dimensional drawings

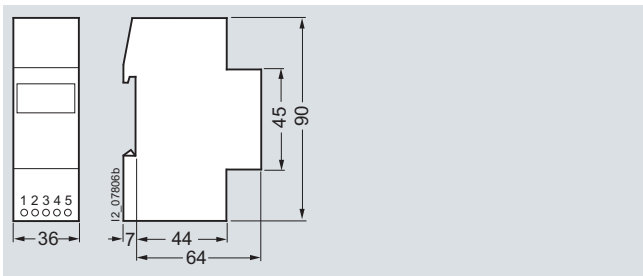

7KT1 110, 7KT1 120

Schematics

Switching examples

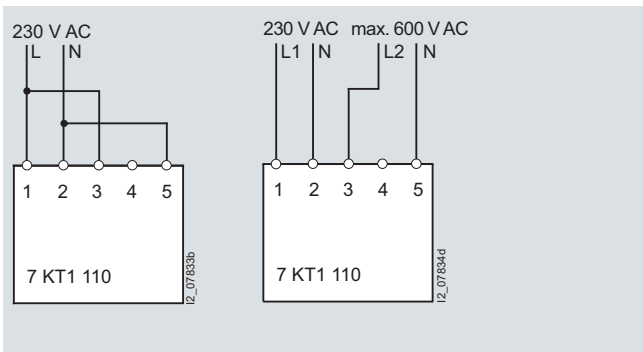

Digital voltmeters

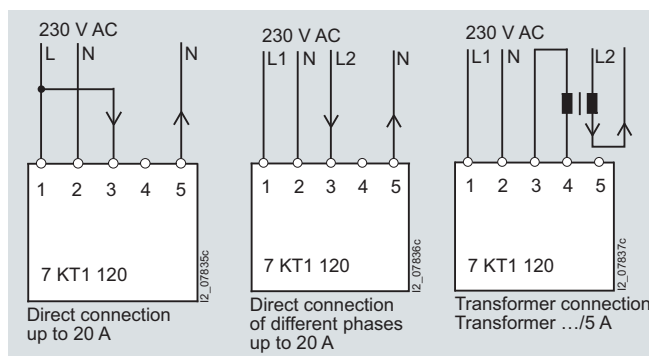

Digital ammeters

More information

Range selector switch for 7KT1 120 digital ammeter

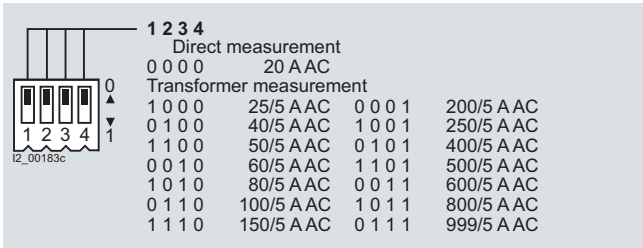

Measuring Devices and E-counters

Time and pulse counters

Time and pulse counters
for standard rail mounting, 7KT5 8

Overview

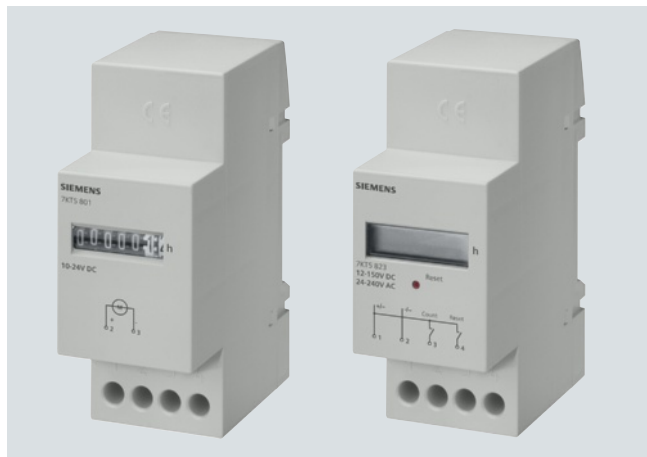

Time counters: Left: electromechanical, right: electronic

Time and pulse counters are used for the reliable monitoring of production and service times, which enables the exact planning and monitoring of production sequences, maintenance cycles and warranty times.

As well as the proven electromechanical time and pulse counters for mounting in distribution boards, we also supply digital time and pulse counters.

The fields of application for both counter types are very diverse, such as the recording of operating hours of machines, systems or building management systems, as well as pulse counting for general volume flow counting, registration of starting frequencies, starting cycles or production quantities in systems and machines.

Technical specifications

		7KT5 801	7KT5 802	7KT5 803	7KT5 804	7KT5 806	7KT5 807
Standards Approvals		DIN VDE 0435-110; EN 60255-6; UL 863 UL 863, UL File No. E300537, CSA C22.2 No. 6 and 55					
Rated control supply voltage U_c	V AC V DC	-- 12 ... 24	24 --	115	230	115	230
Primary operating range	At 50/60 Hz	$\times U_c$ 0.9 ... 1.1					
Rated frequency	Hz	--	50			60	
Rated power dissipation P_v	VA	< 1		< 2			
Method of operation	Counting of	Hours					
Display	Drum-type register	h 00000.00					
Terminals	\pm screw (Phillips)	1					
Conductor cross-sections	Rigid Flexible, with end sleeve, min.	mm ² mm ²		1.5 0.75			
Permissible ambient temperature	°C	-10 ... +70					
Degree of protection	Acc. to EN 60529	IP20, with connected conductors					
Safety class	Acc. to EN 61140/VDE 0140-1	II					
Permissible humidity	%	< 80					

		7KT5 811	7KT5 812	7KT5 814	7KT5 821	7KT5 822	7KT5 823	7KT5 833
Standards Approvals		DIN VDE 0435-110; EN 60255-6; UL 863 UL 863, UL File No. E300537, CSA C22.2 No. 6 and 55						
Rated control supply voltage U_c	V AC V DC	-- 12 ... 24	24 --	230	24 ... 240 12 ... 150			
Primary operating range	At 50/60 Hz	$\times U_c$ 0.9 ... 1.1						
Rated frequency	Hz	--	50/60					
Rated power dissipation P_v	VA	< 1		< 2	< 1			
Method of operation	Counting of	Pulses			Hours			Pulses
Display	Drum-type register LCD	h		0000000	--	000000.0	--	--
		h		--	--	--	--	00000000
Counting frequency	Hz	10			--			10
Pulse duration	ms	50			--			50
Resetting	Electrical Mechanical	--				Yes		Yes
		--						
Terminals	\pm screw (Phillips)	1						
Conductor cross-sections	Rigid Flexible, with end sleeve, min.	mm ² mm ²		1.5 0.75				
Permissible ambient temperature	°C	-10 ... +70						
Degree of protection	Acc. to EN 60529	IP20, with connected conductors						
Safety class	Acc. to EN 61140/VDE 0140-1	II						
Permissible humidity	%	< 80						

Dimensional drawings

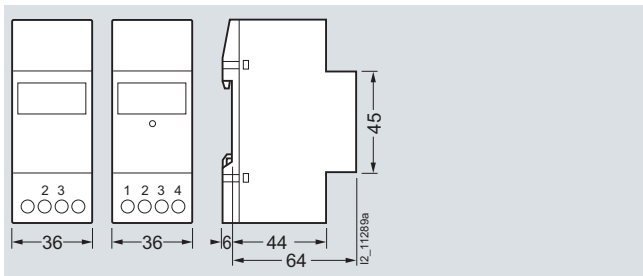

7KT5 80. 7KT5 82.
7KT5 81. 7KT5 833

Schematics

Connections

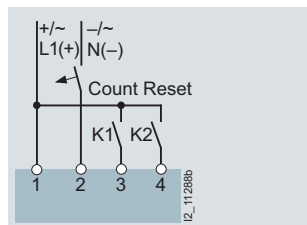
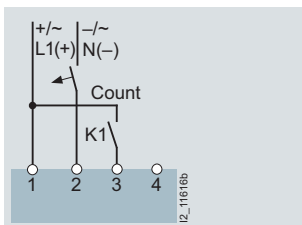
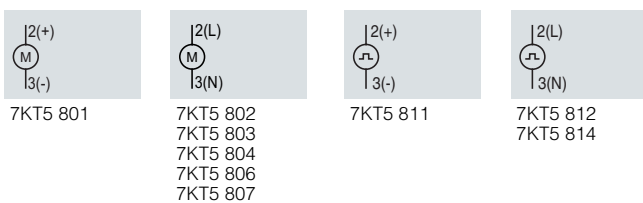

More information

Time counters count the time in hours with an accuracy of two decimal places (hundredths of hours). The pulse counter adds the number of pulses, e.g. the making operations of devices.

A power supply is required at terminals 1 and 3 of the electronic counters so that the device can constantly display the measured values. Once terminal 3 is supplied with voltage (for DC "+"), the

counting procedure starts. If terminal 4 is supplied short-time with voltage (for DC "+"), the counter is reset.

In the case of electronic counters, the counting result is saved indefinitely in the event of a power failure (EEPROM). On recovery of the power, the counting is continued from the saved value. As well as a modern design, the electronic counter has a 7-digit LCD, which can be reset electrically or manually.

Measuring Devices and E-counters

Time and pulse counters

Time counters for front-panel mounting,
7KT5 5, 7KT5 6

Overview



Time counters: Left: counting mechanism, right: counting mechanism with front frame

Time and pulse counters for control cabinets, control and mechanical engineering are used, e.g. in boilers, machine tools or compressors. The pulse counters count the starting frequencies. This supports planning for preventative maintenance.

In-time and regular maintenance is the best protection against unexpected shutdowns.

Technical specifications

		7KT5 500	7KT5 501	7KT5 502	7KT5 503	7KT5 504	7KT5 505
Standards		DIN VDE 0435-110; EN 60255-6					
Rated control supply voltage U_c	V AC V DC	-- 10 ... 80	115 --	230	115	230	24
Primary operating range	$\times U_c$	0.9 ... 1.1					
Rated frequency	Hz	--	50		60		50
Rated power dissipation P_v	VA	< 1	0.2	1.8	0.9	1.8	0.2
Method of operation	Counting of	Hours					
Display	Drum-type register	h					
Pulse duration	Pulse length, pulse interval	ms					
Front-panel mounting	Switchboard cutout	mm × mm					
• Without masking frame 55 mm × 55 mm		45.2 × 45.2 ^{+0.3}					
• With masking frame 55 mm × 55 mm		∅ mm					
		50.2 ^{+0.3}					
Terminals	± screw (Phillips)	1					
Conductor cross-sections	Rigid Flexible, with end sleeve, min.	mm ²		mm ²			
		1.5		0.75			
Permissible ambient temperature	°C	-10 ... +70					
Degree of protection	Acc. to EN 60529	IP65 IP43 IP20, with connected conductors					
• Front panel • Installation with seal • Terminals							
Safety class	Acc. to EN 61140/VDE 0140-1	II					
Permissible humidity	%	< 93					

		7KT5 600	7KT5 601	7KT5 602	7KT5 603	7KT5 604
Standards		DIN VDE 0435-110; EN 60255-6				
Rated control supply voltage U_c	V AC V DC	-- 10 ... 50	115 --	230	115	230
Primary operating range	$\times U_c$	0.9 ... 1.1				
Rated frequency	Hz	--	50		60	
Rated power dissipation P_v	VA	< 1				
Method of operation	Counting of	Hours				
Display	Drum-type register	h				
Pulse duration	Pulse length, pulse interval	ms				
Front-panel mounting	Switchboard cutout	mm × mm				
		68 ^{+0.5} × 68 ^{+0.5}				
Terminals	± screw (Phillips)	1				
Conductor cross-sections	Rigid Flexible, with end sleeve, min.	mm ²		mm ²		
		1.5		0.75		
Permissible ambient temperature	°C	-10 ... +70				
Degree of protection	Acc. to EN 60529	IP52 IP00				
• Front panel • Terminals						
Safety class	Acc. to EN 61140/VDE 0140-1	II				
Permissible humidity	%	< 93				

Dimensional drawings

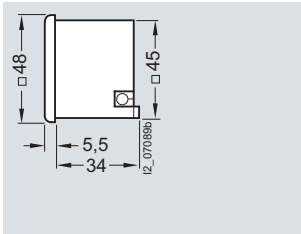

7KT5 5

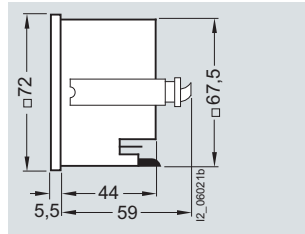

7KT5 6

Schematics

Connections

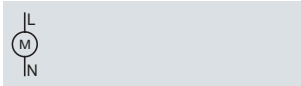

7KT5 5, 7KT5 6

Measuring Devices and E-counters

Accessories

Current transformers, 7KT1 2

Overview

This three-phase current transformer can be used in distribution boards according to DIN 43880. The measuring leads are routed vertically through the standard mounting rail.

This type of current transformer is suitable for supply systems or outgoing conductors in connection with the installation of a 5TE8

switch or a 5TE1 disconnector, as the primary connecting leads do not have to be interrupted.

The current transformer is designed for cables of up to 13 mm in diameter, e.g. H07V-R with 50 mm² conductor cross-section.

Technical specifications

		7KT1 200	7KT1 201	7KT1 202
Standards		EN 60044-1		
Secondary rated current strength	A	5		
Accuracy class	Cl.	1		
Rated power	VA	1.25	2.5	3.75
Rated frequency f_n	Hz	50/60		
Thermal current limit I_{th}	Short-time	A 60 $\times I_e$		
Thermal continuous current	A	1 $\times I_e$		
Overcurrent limit factor	FS	5		
Rated impulse withstand voltage U_{imp}	kV	> 3		
Creepage distances and clearances	mm	> 3		
Rated operational voltage U_e	V AC	720		
Rated operational current I_e	A AC	3 \times 60	3 \times 100	3 \times 150
Terminals \pmscrew (Pozidriv)		PZ 1		
Conductor cross-sections				
- Rigid	mm ²	0.5 ... 4		
- Flexible, with end sleeve	mm ²	0.5 ... 2.5		
Permissible ambient temperature	°C	-5 ... +60		
Resistance to climate	Acc. to EN 60068-1	20/60/4		

Dimensional drawings

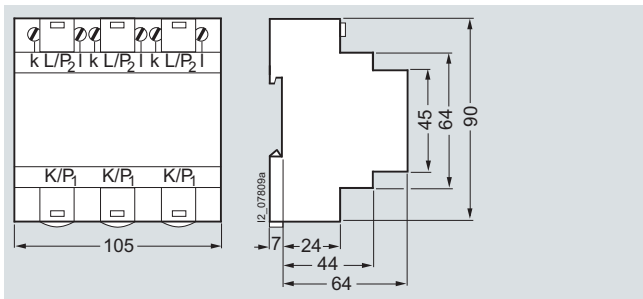

7KT1 200
7KT1 201
7KT1 202

Schematics

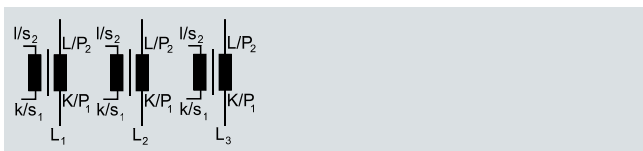

7KT1 200
7KT1 201
7KT1 202

Note:

Current transformers must not be operated with open terminals as this can result in dangerously high voltages, which may cause personal injury and/or property damage. It also exposes the transformer to thermal overload.

Measuring selector switches, 7KT9 0

Overview

Measuring selector switches are used as CO contacts of the phases for voltages and currents in three-phase systems for voltmeters and ammeters.

The design of these switches is adapted to match the modular installation devices. They support use in compliance with EN 60947-3.

Dimensional drawings

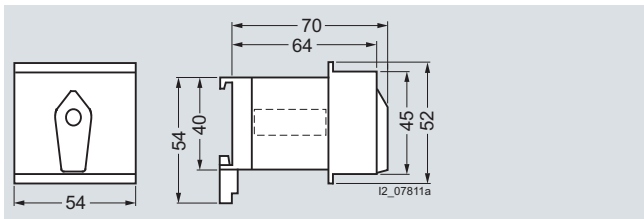

7KT9 010
7KT9 011

Schematics

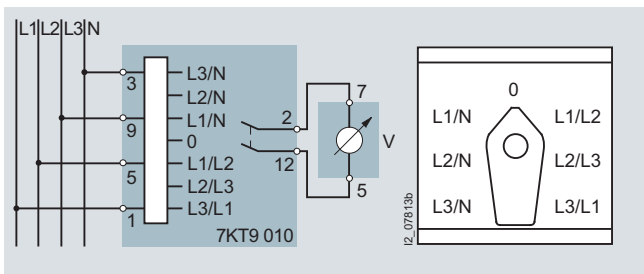

Voltmeter switching

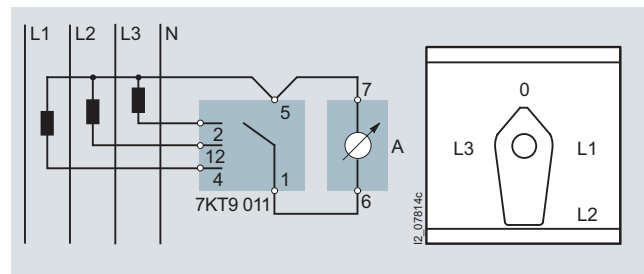

Ammeter switching

Internal interconnection of the phases in the ammeter selector switch for the prevention of glitches at the connections of the current transformers:

Switch position	Short-circuited phases		
	L1	L2	L3
0	✓	✓	✓
L1	--	✓	✓
L2	✓	--	✓
L3	✓	✓	--

Measuring Devices and E-counters

Notes



Siemens AG
Industry Sector
Building Technologies Division
Low Voltage Distribution
Postfach 10 09 53
93009 REGENSBURG
GERMANY

www.siemens.com/lowvoltage

Subject to change without prior notice
PDF only
3P.8303.54.27
PH 0611 40 En
© Siemens AG 2011

The information provided in this configuration Manual contains descriptions or characteristics of performance which in case of actual use do not always apply as described or which may change as a result of further development of the products. An obligation to provide the respective characteristics shall only exist if expressly agreed in the terms of contract. Availability and technical specifications are subject to change without notice.

All product designations may be trademarks or product names of Siemens AG or supplier companies whose use by third parties for their own purposes could violate the rights of the owners.