



Technical catalogue - Edition 2011

# Insulating enclosures and installation material



# Summary

---

**Presentation**

**1**

---

**Consumer units**

**2**

---

**Emergency consumer units**

**3**

---

**Unifix cabling system**

**4**

---

**Switchboards**

**5**

---

**Boxes, equipment and various components**

**6**

---

**Wiring accessories and junction boxes**

**7**

---

**Installation material**

**8**

---

**Further technical information and applications**

**9**

---

**Overall dimensions**

**10**

---

**Code list**

**11**

---





## Index

Products offered by ABB for distribution in the residential and tertiary sectors .....	1/2
The benefits of a full and integrated range	
Gemini switchboards and plastic and metal conduit pipe systems .....	1/5
Élos and Chiara civil series .....	1/6
Technical documentation .....	1/8

# Products offered by ABB for distribution in the residential and tertiary sectors

**1** ABB offers a range of consumer units and switchboards for the installation of modular components that enables to implement any type of application for power distribution in the residential and tertiary environments operating under the highest safety conditions and with significant savings of time.

Among the several products that form this offer, the Unibox consumer units are distinguished by a design, which perfectly fits into any decor, choosing between the wall-mounting version and the new flush-mounting version. Estetica and Europa Series consumer units and the wall-mounting covers are available in the modern RAL 9016 white. In the range of switchboards, the Livorno Series meets first of all the requirements arising in emergency situations in which a fast and efficient operating mechanism for shutdown of plant is required.



To execute the terminal part of an electric plant, ABB offers a range of products that includes empty enclosures and control devices, also in versions for installation in rigid and protective conduits.

Junction and wiring accessories boxes present a safe use even under the most difficult environmental conditions: in particular waterproof boxes guarantee full protection in operations for junction, branch connection and installation of equipments.

In a "state of the art" electric plant, even details are carefully implemented. To secure total use safety and operational efficiency of the plant, minor components and accessories for erection of electrical equipment of ABB are made in compliance with the reference international Standards; metal section bars, cable-ties and fixing and cabling accessories are available in a wide assortment to satisfy any kind of application.

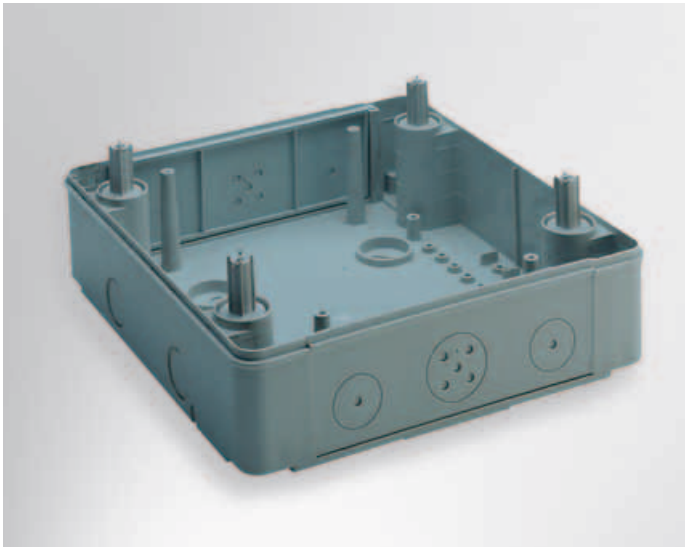

# Products offered by ABB for distribution in the residential and tertiary sectors

## Unibox consumer units: elegant and functional even in the flush-mounting version

1

Unibox doubles.

Elegant design and practicality for installation and use are now available also in the flush-mounting version of the consumer units IP 40 of ABB SACE for application in the residential and tertiary environments.

The new Unibox consumer units, manufactured in a self-extinguishing thermoplastic material of colour RAL 9016 white, integrate themselves easily in whichever decoration solution; for the door, it is possible to choose between the transparent smoked version and the opaque version.

The models in the range can accommodate equipments of 8 to 54 modules that can be cabled more easily extracting the frame to work on the bench.

Resistance to chemical agents, atmospheric agents, UV rays and shocks is guaranteed; protection degree is IP 40.

Accessories make it possible to design their configuration with an accurate repartition of outlines, and a particular completeness of functions.

The flush-mounting Unibox consumer units are manufactured in compliance with CEI 23-48 and 23-49 Standards, and IEC 670. They have obtained the IMQ approval.

Functionality and safety of installation and use of the new flush-mounting Unibox consumer units guarantee quality of construction characteristics, in particular:

- protection degree IP 40;
- insulation class II;
- self-extinguishing thermoplastic material and resistant to abnormal heat and fire up to 650 °C (glow wire test), in compliance with IEC 695-2-1 Standard;
- installation temperature from -20 °C to + 85 °C;
- shock resistance: 10 Joules (IK level 09);

- reversible door;
- door opening with push-pull mechanism;
- opening of the door up to 180 ° for multi-row consumer units;
- equipped with a film protected door;
- a lock with a coded key can be fitted;
- flush-mounting box with push-in inlet for entrance of protective corrugated conduits;
- extractable DIN rail frame;
- DIN 150 mm inter-axis between the rows;
- terminal holders and terminal bars supplied separately or already assembled;
- equipped with slots at the engagement points to compensate possible defects during the installation of the flush-mounting box.



# The benefits of a full and integrated range Gemini switchboards and plastic and metal conduit pipe systems

When the plant is designed with a whole series of functions, ABB has the right product for every situation. All products in the range give quality performance, are easy to assemble and highly reliable.

1



## Gemini switchboards

When setting up low voltage insulating switchgear, the ABB Gemini series ensures the best protection and proper operating conditions of all modular devices. Also suited for automation applications, they are available in six different sizes.

By using co-injection moulding technology, Gemini switchboards maintain their outstanding mechanical properties, as well as their sturdiness and resistance to weather and aggressive agents over the years. In this way they can be used in any type of environment, whether inside or outside. This is further aided by their high IP66 protection rating.

The snap-on frame, with vertical conduit built into the uprights according to an exclusive ABB patent, is used in distribution applications.

For automation applications, Gemini switchboards are supplied with a complete snap-on base plate (selected from three versions) which can be adjusted to different levels of depth. Installation of the hingable inner door or switch panels adequately completes the switchboard.

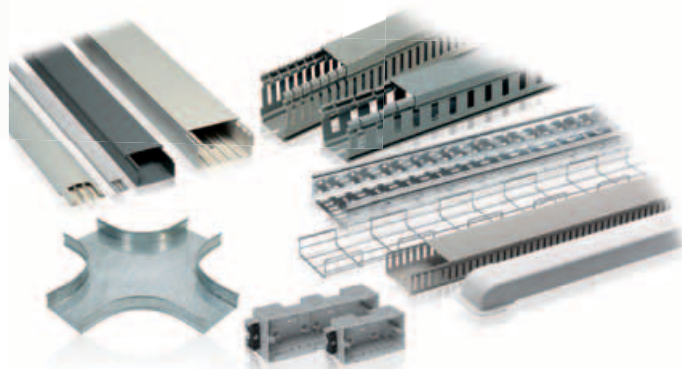

## Conduit pipe systems

Its experience in designing and producing conduit pipe systems allows ABB to offer a complete range of products that offer solutions perfect for any situation, in both plant engineering and installation.

High standards of production and strict controls ensure that the most severe functional and aesthetic parameters are followed so that these products are absolutely flexible in their use in both new buildings and renovation and expansion works.

The range includes channels and mini-channels made of an impact-resistant and self-extinguishing thermoplastic material, channels used as baseboard, frames and floor-mounted channels.

Wiring raceways in either rigid or flexible bars for switchboards, channels for air conditioning systems, industrial conduit pipe systems in plastic and hot-galvanised metal, in the closed or perforated version, and industrial gangways in steel wire particularly suitable in all those cases where flexibility and easy service during maintenance is required.



# The benefits of a full and integrated range Élos and Chiara civil series

**1** Élos and Chiara are the civil series whose materials, shapes and colours are amazing. There is an endless number of possible combinations to meet all tastes and fancies.



## Élos civil series

The Élos Soft and Élos Smart plates are in the colours of nature and of its four elements, in 24 shades for the metal versions, in 17 for those made of technopolymer and in 6 for the glass versions, carefully selected finishes and materials to meet the various interior design styles and to increase the possibilities of customising the selection.

The Élos shapes were not left to chance.

Creativity and industrial design have produced two lines having precise features. The Élos Soft plates have the sophisticated and sinuous silhouette of a wave that gives the rooms personality and importance. The Élos Smart plates feature essential and modern lines that integrate with any furnishing style.

The Élos plates have the colours of nature and are available in 24 shades for the metal versions, in 17 for those made of technopolymer and in 6 for those made of glass. All of the different interior decor styles are satisfied with the carefully selected finishes and materials so the possibilities of customising the selections are increased.





Chiara civil series

As its name conveys, Chiara ("clear") is light and harmony. The elegance of the white buttons and plugs interpenetrates with the evocative shades of the plates: white, sand, stone, volcano and the hues of metal and pastels. The 22-mm-wide plugs are suited to being put inside all of the flush-mounted enclosures, whether they are round (ø 60 mm) or rectangular. The supports and plates are available in the two, three, four and seven-module versions that can be mounted in standard rectangular two, three, four and six-module enclosures, respectively.

The design of Chiara is a statement of top Italian creativity combined with the excellence of ABB's technological and production processes. Chiara meets everyone's tastes, and enhances any room - from the most sophisticated to the most essential - with a choice of components that makes it possible to implement the leading application solutions in the residential and service sectors. Flexibility is a characteristic of Chiara, also from the installation viewpoint.

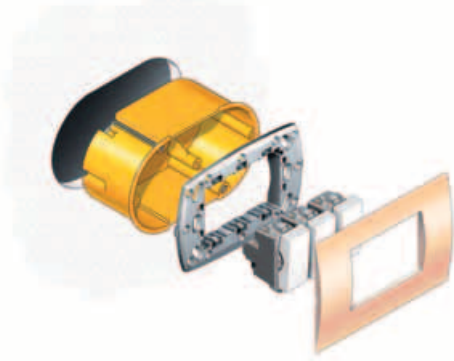

Flush-mounted in movable or plasterboard walls

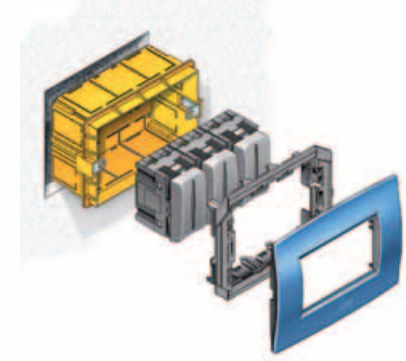

Flush-mounted in masonry walls

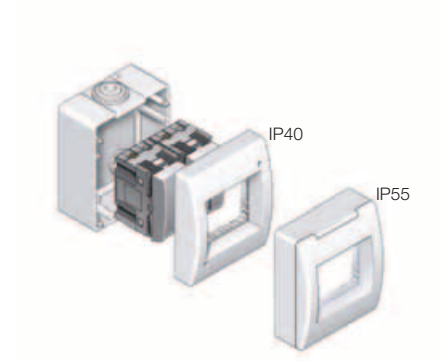

Wall-mounted in protected enclosures

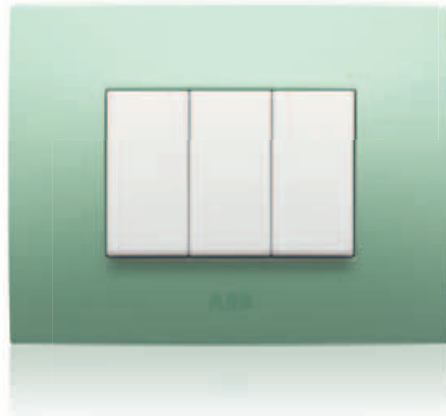
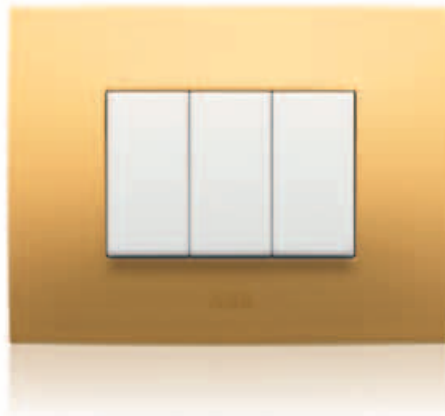
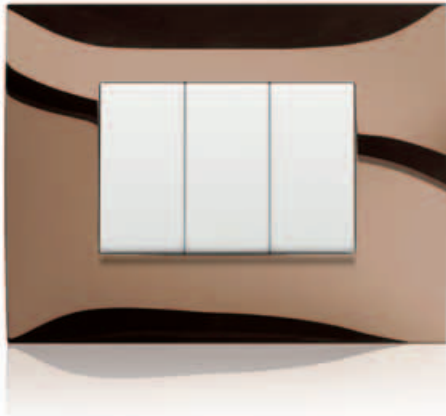

# Technical documentation

**1** Catalogues with the ABB product range for the residential and service sectors are available in PDF format at the website:  
[www.abb.com/abblibrary/downloadcenter/](http://www.abb.com/abblibrary/downloadcenter/)

- **Gemini**

**Low voltage electric insulating switchboards**

1SLC805001D0204

- **Plastic and metal trunking systems**

1SLC800001D0201

- **Floor distribution systems**

1SLC006001D0201













## Index

Summary table .....	2/2
<b>IP 40 flush-mounting consumer units</b>	
Unibox Series .....	2/5
Estetica Series .....	2/11
Europa Series .....	2/17
<b>IP 40 wall-mounting consumer units</b>	
Unibox Series .....	2/23
Europa Series .....	2/29
Europa Polycarbonate Series .....	2/35
Wall-mounting covers .....	2/41
<b>IP 55 wall-mounting consumer units</b>	
IP 55 Europa Series .....	2/45
<b>IP 65 wall-mounting consumer units</b>	
IP 65 Fly Series .....	2/49
IP 65 Europa Series .....	2/55
<b>IP 40 and IP 55 panel fronts</b>	
IP 40 fronts .....	2/61
IP 55 fronts .....	2/61

# Consumer units

## Summary table

2

Modules	IP 40 flush-mounting consumer units					IP 40 wall-mounting consumer units			
	Unibox Series residential application	Estetica Series residential application	Europa Series residential application	Unibox Series residential/tertiary application	Europa Series residential/ tertiary application	Unibox Series residential/tertiary application	Unibox Series residential/tertiary application	Unibox Series residential/tertiary application	Europa Series residential/ tertiary application
									
	With opaque, vertically hinged door	With transparent, smoky, vertically hinged door	With transparent, smoky, horizontally hinged door	Without door	Without door	With opaque, vertically hinged door	With transparent, smoky, vertically hinged door	With transparent, smoky, vertically hinged door	Without door
	RAL 9016 white	RAL 9016 white	RAL 9016 white RAL 7021 grey	RAL 9016 white RAL 7035 grey	RAL 9016 white RAL 7035 grey	RAL 9016 white	RAL 9016 white	RAL 9016 white	RAL 9016 white RAL 7035 grey
<b>2</b>	-	-	-	-	-	-	-	-	-
<b>3</b>	-	-	-	-	-	-	-	-	-
<b>4</b>	-	-	<b>1SL2024A00 - 12 037</b> 160x180x90	-	-	-	-	-	-
<b>6</b>	-	-	-	-	-	-	-	-	-
<b>8</b>	<b>1SL0500A00</b> 214x238x110	<b>1SL0510A00</b> 214x238x110	<b>1SL2028A00 - 12 038</b> 230x180x90	<b>1SL2040A00 - 12 026</b> 230x190x90	<b>1SL2057A00 - 12 058</b> 230x180x90	<b>12 208</b> 215x220x105	<b>12 238</b> 215x220x105	<b>12 258</b> 215x220x105	<b>1SL2408A00 - 12 428</b> 230x200x95
<b>10</b>	-	-	-	-	-	-	-	-	-
<b>12</b>	<b>1SL0501A00</b> 293x262x110	<b>1SL0511A00</b> 293x262x110	<b>1SL2032A00 - 12 042</b> 300x180x90	<b>1SL2041A00 - 12 027</b> 300x180x90	<b>1SL2061A00 - 12 062</b> 300x180x90	<b>12 212</b> 295x245x115	<b>12 242</b> 295x245x115	<b>12 262</b> 295x245x115	<b>1SL2412A00 - 12 432</b> 305x200x95
<b>18</b>	-	-	<b>1SL2033A00 - 12 043</b> 410x180x90	-	-	-	-	-	-
<b>20</b>	-	-	-	-	-	-	-	-	-
<b>24</b>	<b>1SL0502A00</b> 293x408x118	<b>1SL0512A00</b> 293x408x118	<b>1SL2034A00 - 12 044</b> 300x395x100	<b>1SL2045A00 - 12 030</b> 300x395x90	<b>1SL2063A00 - 12 064</b> 300x395x90	<b>12 214</b> 295x390x115	<b>12 244</b> 295x390x115	<b>12 264</b> 295x390x115	<b>1SL2414A00 - 12 434</b> 305x350x95
<b>36</b>	<b>1SL0503A00</b> 293x533x118	<b>1SL0513A00</b> 293x533x118	<b>1SL2036A00 - 12 046</b> 300x545x100	<b>1SL2048A00 - 12 031</b> 300x545x90	<b>1SL2065A00 - 12 066</b> 300x545x90	<b>12 216</b> 295x515x115	<b>12 246</b> 295x515x115	<b>12 266</b> 295x515x115	<b>1SL2416A00 - 12 436</b> 305x545x120
<b>54</b>	<b>1SL0504A00</b> 401x533x118	<b>1SL0514A00</b> 401x533x118	-	<b>1SL2052A00 - 12 035</b> 410x545x90	<b>1SL2067A00 - 12 068</b> 410x545x100	<b>12 217</b> 405x515x115	<b>12 247</b> 405x515x115	<b>12 267</b> 405x515x115	<b>1SL2417A00 - 12 437</b> 380x570x120

# Consumer units

## Summary table

IP 40 wall-mounting consumer units				IP 55 and IP 65 wall-mounting consumer units				Fronts	
Europa Series	Europa Polycarbonate Series	Wall covers	IP 55 Europa Series	IP 65 Fly Series	IP 65 Europa Series			IP 40 and IP 55 panel fronts	
residential/ tertiary application	tertiary/ industrial application	residential/ tertiary application	tertiary/industrial application	residential/ tertiary/ industrial application	residential/ tertiary/industrial application			tertiary/industrial application	
									
With opaque, vertically hinged door	With transparent, smoky, vertically hinged door	Without door	Without door	Spring closing	With transparent door	With opaque, vertically hinged door	With transparent, smoky vertically hinged door	Panel fronts	
RAL 9016 white RAL 7035 grey	RAL 9016 white RAL 7035 grey	RAL 7035 grey	RAL 9016 white RAL 7035 grey	RAL 7035 grey	RAL 7035 grey	RAL 7035 grey	RAL 7035 grey	IP 40 RAL 7035 grey	IP 55
-	-	2-4 modules <b>12 702</b> 105x175x85	<b>1SL2402A00 - 12 422</b> 50x140x65	-	2-4 modules <b>12 742 - 12 722<sup>(*)</sup></b> 105x175x100	-	-	<b>12 362</b> 81x90x50	-
-	-	-	-	-	-	-	-	<b>12 363</b> 99x90x50	-
-	-	<b>12 704</b> 140x220x110	<b>1SL2404A00 - 12 424</b> 95x160x65	<b>12 644</b> 125x180x105	-	<b>12 724</b> 140x220x140	<b>12 744</b> 140x220x140	<b>12 364</b> 117x90x50	<b>12 658</b> 125x180x80
-	-	-	<b>1SL2406A00 - 12 426</b> 140x160x65	<b>12 646</b> 160x180x105	-	-	-	-	<b>12 659</b> 160x180x80
<b>1SL2438A00 - 12 448</b> 230x200x95	<b>1SL2458A00 - 12 468</b> 230x200x95	<b>12 708</b> 205x220x110	-	-	<b>12 743</b> 205x220x140	<b>12 728</b> 205x220x140	<b>12 748</b> 205x220x140	-	-
-	-	-	-	<b>12 650</b> 230x180x105	-	-	-	-	<b>12 660</b> 230x180x80
-	-	-	-	<b>12 654</b> 250x320x139	-	-	-	-	-
<b>1SL2442A00 - 12 452</b> 305x200x95	<b>1SL2462A00 - 12 472</b> 305x200x95	<b>12 712</b> 275x220x110	-	-	<b>12 745</b> 275x220x140	<b>12 732</b> 275x220x140	<b>12 752</b> 275x220x140	-	-
-	-	-	-	-	-	<b>12 733</b> 380x220x140	<b>12 753</b> 380x220x140	-	-
-	-	-	-	<b>12 652</b> 250x320x135	-	-	-	-	-
<b>1SL2444A00 - 12 454</b> 305x350x95	<b>1SL2464A00 - 12 474</b> 305x350x95	<b>12 714</b> 275x370x110	-	-	<b>12 746</b> 275x370x140	<b>12 734</b> 275x370x140	<b>12 754</b> 275x370x140	-	-
-	-	-	-	-	-	<b>12 735</b> 380x370x140	<b>12 755</b> 380x370x140	-	-
<b>1SL2446A00 - 12 456</b> 305x545x120	<b>1SL2466A00 - 12 476</b> 305x545x120	<b>12 716</b> 275x570x110	-	-	<b>12 747</b> 275x570x140	<b>12 736</b> 275x570x140	<b>12 756</b> 275x570x140	-	-
<b>1SL2447A00 - 12 457</b> 380x570x120	<b>1SL2467A00 - 12 477</b> 380x570x120	<b>12 718</b> 380x570x120	-	-	-	<b>12 738</b> 380x570x140	<b>12 758</b> 380x570x140	-	-

Residential application



1SLC001002R0001

# IP 40 flush-mounting consumer units

## Unibox Series

### Technical characteristics

- protection degree **IP 40**
- insulation class **II** 
- available in 2 versions: with **transparent, smoky door** and with **opaque door** both with vertical hinge
- colour **RAL 9016 white**
- available in self-extinguishing **thermoplastic** material, resistant to abnormal heat and fire up to 650 °C (glow wire flammability index) in compliance with IEC 60695-2-11 Standard
- installation temperature from -15 °C to +60 °C
- resistant to heat: ball thermopressure up to +85 °C in compliance with EN 60695-10-2 Standard
- shock resistance 10 Joules (**IK level 09**)
- door opening with push-pull mechanism
- reversible door with protective film (to be removed only after the installation is completed), designed to be fitted with a coded lock
- flush-mounting box with push-in inlet for entrance of protective corrugated conduits
- **extractable DIN rail frame to facilitate bench cabling**
- DIN 150 mm inter-axis between the rows
- consumer units manufactured to compensate possible defects during the installation (thanks to slots at the points where the front parts are hooked on)
- consumer units manufactured in compliance with CEI 23-49 (1996) + V1 + V2, CB certificate IEC 60670-24 Standards
- consumer units are supplied complete with:
  - module covers
  - 1 self-adhesive indicator strip per row
  - 1 plate for CEI 23-51 certification
  - instruction sheet
- to meet the installation needs of flush-mounting consumer units, separate codes are available for the flush-mounting box and the front of the consumer unit, as well as for the flush-mounting box with terminal bars
- consumer units are RoHs compliance and Halogen free (excluded plastered box).

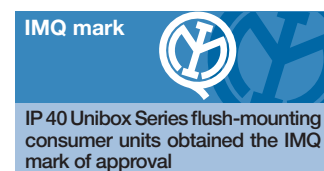

1SLC001001FC001

# IP 40 flush-mounting consumer units

## Unibox Series

8 modules

12 modules

24 modules

With transparent, smoky vertically hinged door

RAL 9016 white

2



Code	Dimensions (mm) WxHxD	Box/pack No items
Flush-mounting box with front		
<b>1SL0510A00</b>	214x238x110	1/9
Flush-mounting box		
<b>1SL0521A00</b>	215x183x73	1/18
Front		
<b>1SL0532A00</b>	214x238x37,5	1/18
Flush-mounting box with front and terminal bars		
<b>1SL0510A06</b>	214x238x110	1/9

Code	Dimensions (mm) WxHxD	Box/pack No items
Flush-mounting box with front		
<b>1SL0511A00</b>	293x262x110	1/7
Flush-mounting box		
<b>1SL0522A00</b>	284x183x73	1/14
Front		
<b>1SL0536A00</b>	293x262x37,5	1/14
Flush-mounting box with front and terminal bars		
<b>1SL0511A06</b>	293x262x110	1/7

Code	Dimensions (mm) WxHxD	Box/pack No items
Flush-mounting box with front		
<b>1SL0512A00</b>	293x408x118	1/5
Flush-mounting box		
<b>1SL0524A00</b>	280x370x80	1/4
Front		
<b>1SL0542A00</b>	293x408x37,5	1/4
Flush-mounting box with front and terminal bars		
<b>1SL0512A06</b>	293x408x118	1/5

With opaque, vertically hinged door

RAL 9016 white



Code	Dimensions (mm) WxHxD	Box/pack No items
Flush-mounting box with front		
<b>1SL0500A00</b>	214x238x110	1/9
Flush-mounting box		
<b>1SL0521A00</b>	215x183x73	1/18
Front		
<b>1SL0533A00</b>	214x238x37,5	1/18
Flush-mounting box with front and terminal bars		
<b>1SL0500A06</b>	214x238x110	1/9

Code	Dimensions (mm) WxHxD	Box/pack No items
Flush-mounting box with front		
<b>1SL0501A00</b>	293x262x110	1/7
Flush-mounting box		
<b>1SL0522A00</b>	284x183x73	1/14
Front		
<b>1SL0537A00</b>	293x262x37,5	1/14
Flush-mounting box with front and terminal bars		
<b>1SL0501A06</b>	293x262x110	1/7

Code	Dimensions (mm) WxHxD	Box/pack No items
Flush-mounting box with front		
<b>1SL0502A00</b>	293x408x118	1/5
Flush-mounting box		
<b>1SL0524A00</b>	280x370x80	1/4
Front		
<b>1SL0543A00</b>	293x408x37,5	1/4
Flush-mounting box with front and terminal bars		
<b>1SL0502A06</b>	293x408x118	1/5

# IP 40 flush-mounting consumer units

## Unibox Series

36 modules

54 modules

With transparent, smoky vertically hinged door

RAL 9016 white



Code	Dimensions (mm) WxHxD	Box/pack No items
<b>1SL0513A00</b>	293x533x118	1/3
Flush-mounting box with front and terminal bars		
<b>1SL0513A06</b>	293x533x118	1/3

Code	Dimensions (mm) WxHxD	Box/pack No items
<b>1SL0514A00</b>	401x533x118	1/1
Flush-mounting box with front and terminal bars		
<b>1SL0514A06</b>	401x533x118	1/1

With opaque, vertically hinged door

RAL 9016 white



Code	Dimensions (mm) WxHxD	Box/pack No items
<b>1SL0503A00</b>	293x533x118	1/3
Flush-mounting box with front and terminal bars		
<b>1SL0503A06</b>	293x533x118	1/3

Code	Dimensions (mm) WxHxD	Box/pack No items
<b>1SL0504A00</b>	401x533x118	1/1
Flush-mounting box with front and terminal bars		
<b>1SL0504A06</b>	401x533x118	1/1

### Terminal bars configuration

No modules	N	PE
	(holes x mm <sup>2</sup> )	(holes x mm <sup>2</sup> )
8	(10 x 16)+(3 x 25)	(5 x 16)
12	(10 x 16)+(3 x 25)	(10 x 16)+(3 x 25)
24	(16 x 16)+(3 x 25)+(5 x 16)	(16 x 16)+(3 x 25)+(5 x 16)
36	(15 x 16)+(6 x 25)+(5 x 16)	(15 x 16)+(6 x 25)+(5 x 16)
54	(10 x 16)+(3 x 25)+(19 x 16)+(6 x 25)	(10 x 16)+(3 x 25)+(19 x 16)+(6 x 25)



# IP 40 flush-mounting consumer units

## Accessories for Unibox Series

### Terminal blocks

The complete terminal blocks are composed of a combination of terminal holders and terminal bars as indicated in the description, with the terminal bars already mounted on terminal holders.

Configuration of the complete terminal block is standard. For different requirements (customized terminal block), the terminal holders and bars must be procured separately in the versions indicated in the table.



Code	Description	Box/pack No. items
<b>12 492</b>	for 8 modules – composed of 12540x1 + 12531x1 + 12532x1	10/40
<b>12 495</b>	for 12 modules – composed of 12541x1 + 12532x2	10/40
<b>12 504</b>	for 24 modules – composed of 12541x2 + 12531x2 + 12533x2	10/40
<b>12 505</b>	for 36 modules – composed of 12541x2 + 12531x2 + 12534x2	10/40
<b>12 506</b>	for 54 modules – composed of 12542x2 + 12532x2 + 12535x2	5/20

### Terminal holders

RAL 7035 grey



### Terminal bars

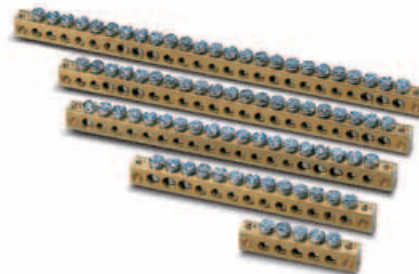

Code	Description	For consumer units type	Box/Pack No items
<b>12 540</b>	for 8 modules	1SL0500A00 – 1SL0510A00	12/144
<b>12 541</b>	for 12 modules per row	1SL0501A00 – 1SL0511A00 1SL0502A00 – 1SL0512A00 1SL0503A00 – 1SL0513A00	12/144
<b>12 542</b>	for 18 modules per row	1SL0504A00 – 1SL0514A00	12/108

The terminal block is completed by combining the necessary terminal bars to the terminal holders, taking care to keep the terminal bars separated from each other.

Code	Description	Box/pack No items
<b>12 531</b>	5x16	20/240
<b>12 532</b>	10x16 + 3x25	20/240
<b>12 533</b>	16x16 + 3x25	20/240
<b>12 534</b>	15x16 + 6x25	20/240
<b>12 535</b>	19x16 + 6x25	20/240

The terminal bars can be installed on any kind of terminal holder; they are snapped onto these with 2 clips per bar, through two holes made at the ends of the bar itself.

Terminal holders and terminal bars are supplied separately. In this way, by inserting one or two terminal bars into the terminal holder you can create the best terminal for your requirements, with the advantage of obtaining a terminal block that is cheap as well as personalised, due to the fact that you only need to use material that is really necessary. Some standard configurations are illustrated in the table.

All the possible configurations that can be created for each type of consumer unit are given in the technical details.



# IP 40 flush-mounting consumer units

## Accessories for Unibox Series

### Spare doors



Opaque RAL 9016 white	For consumer units type	Box/pack No items
<b>12 511</b>	1SL0500A00	1/25
<b>12 512</b>	1SL0501A00	1/15
<b>12 513</b>	1SL0502A00	1/10
<b>12 514</b>	1SL0503A00	1/5
<b>12 515</b>	1SL0504A00	1/5

Transparent smoky	For consumer units type	Box/pack No items
<b>12 521</b>	1SL0510A00	1/25
<b>12 522</b>	1SL0511A00	1/15
<b>12 523</b>	1SL0512A00	1/10
<b>12 524</b>	1SL0513A00	1/5
<b>12 525</b>	1SL0514A00	1/5

The mechanism for push-pull code No 12526 (in packs of 5 items) should be always ordered with each door.

### Lock with key



Code	Description	Box/pack No items
<b>12 530</b>	coded type	20/300

### Plastered panel box - GWT 850 °C



Code	Description	Box/pack No items
<b>1SL0527A00</b>	8 modules	1/18
<b>1SL0528A00</b>	12 modules	1/14
<b>1SL0529A00</b>	24 modules	1/8

Complete with assembly accessories

### Module covers



Code	Colour	No modules	Box/pack No items
<b>1SL2857A00</b>	RAL 9016 white	1	50/1500
<b>1SL2859A00</b>	RAL 9016 white	4	25/300

### Screw lead sealing accessory



Code	Box/pack No items
<b>12 860</b>	50/1500

Residential application



FLC09800

# IP 40 flush-mounting consumer units

## Estetica Series

### Technical characteristics

- protection degree IP 40
- insulation class II 
- available with transparent smoky door with horizontal hinge
- available in the following material:
  - RAL 9016 white and RAL 7021 grey thermoplastic, self-extinguishing and resistant to abnormal heat and fire up to 650 °C (glow wire flammability index) in compliance with IEC 60695-2-11 Standard
- installation temperature from -15 °C to +60 °C
- resistant to heat: ball thermopressure up to +85 °C in compliance with EN 60695-10-2 Standard
- shock resistance 6 Joules
- flush-mounting enclosure with push-in inlet for entrance of protective corrugated conduits
- extractable DIN rail frame to facilitate bench cabling
- consumer units manufactured to compensate possible defects during the installation (thanks to slots at the points where the front parts are hooked on)
- consumer units manufactured in compliance with CEI 23-49 (1996) + V1 + V2, CB certificate IEC 60670-24 Standards
- consumer units are supplied complete with:
  - module covers
  - aesthetic flanges for covering the housing door holes (2 flanges supplied for each door; only for models without door)
  - 1 self-adhesive indicator strip per row
  - 1 plate for CEI 23-51 certification
  - instruction sheet
- to meet the installation needs of flush-mounting consumer units, separate codes are available for the flush-mounting box and the front of the consumer unit
- consumer units white RAL9016 are RoHs compliance and Halogen free (excluded plastered box).



1SLC001094F0001

# IP 40 flush-mounting consumer units

## Estetica Series

### 4 modules

### 8 modules

### 12 modules

#### With transparent, smoky horizontally hinged door

RAL 9016 white

2



Code	Dimensions (mm) WxHxD	Box/pack No items
Flush-mounting box with front <b>1SL2024A00</b>	160x180x90	1/24
Flush-mounting box <b>1SL0520A00</b>	114x168x73	1/25
Front <b>1SL0531A00</b>	160x180x23	1/25



Code	Dimensions (mm) WxHxD	Box/pack No items
Flush-mounting box with front <b>1SL2028A00</b>	230x180x90	1/14
Flush-mounting box <b>1SL0521A00</b>	215x183x73	1/18
Front <b>1SL0535A00</b>	230x180x23	1/18



Code	Dimensions (mm) WxHxD	Box/pack No items
Flush-mounting box with front <b>1SL2032A00</b>	300x180x90	1/10
Flush-mounting box <b>1SL0522A00</b>	284x183x73	1/14
Front <b>1SL0539A00</b>	300x180x23	1/14

#### With transparent, smoky horizontally hinged door

RAL 7021 grey



Code	Dimensions (mm) WxHxD	Box/pack No items
Flush-mounting box with front <b>12 037</b>	160x180x90	1/24
Flush-mounting box <b>1SL0520A00</b>	114x168x73	1/25
Front <b>1SL0553A00</b>	160x180x23	1/25



Code	Dimensions (mm) WxHxD	Box/pack No items
Flush-mounting box with front <b>12 038</b>	230x180x90	1/14
Flush-mounting box <b>1SL0521A00</b>	215x183x73	1/18
Front <b>1SL0554A00</b>	230x180x23	1/18



Code	Dimensions (mm) WxHxD	Box/pack No items
Flush-mounting box with front <b>12 042</b>	300x180x90	1/10
Flush-mounting box <b>1SL0522A00</b>	284x183x73	1/14
Front <b>1SL0555A00</b>	300x180x23	1/14

# IP 40 flush-mounting consumer units

## Estetica Series

### 18 modules

### 24 modules

### 36 modules

With transparent, smoky horizontally hinged door

RAL 9016 white



Code	Dimensions (mm) WxHxD	Box/pack No items
Flush-mounting box with front <b>1SL2033A00</b>	410x180x90	1/6
Flush-mounting box <b>1SL0523A00</b>	384x183x73	1/9
Front <b>1SL0541A00</b>	410x180x23	1/9



Code	Dimensions (mm) WxHxD	Box/pack No items
Flush-mounting box with front <b>1SL2034A00</b>	300x395x100	1/5
Flush-mounting box <b>1SL0524A00</b>	280x370x80	1/4
Front <b>1SL0546A00</b>	300x395x23	1/4



Code	Dimensions (mm) WxHxD	Box/pack No items
<b>1SL2036A00</b>	300x545x100	1/3

With transparent, smoky horizontally hinged door

RAL 7021 grey

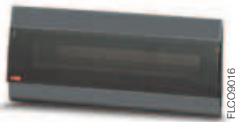

Code	Dimensions (mm) WxHxD	Box/pack No items
Flush-mounting box with front <b>12 043</b>	410x180x90	1/6
Flush-mounting box <b>1SL0523A00</b>	384x183x73	1/9
Front <b>1SL0556A00</b>	410x180x23	1/9



Code	Dimensions (mm) WxHxD	Box/pack No items
Flush-mounting box with front <b>12 044</b>	300x395x100	1/5
Flush-mounting box <b>1SL0524A00</b>	280x370x80	1/4
Front <b>1SL0547A00</b>	300x395x23	1/4



Code	Dimensions (mm) WxHxD	Box/pack No items
<b>12 046</b>	300x545x100	1/3

# IP 40 flush-mounting consumer units

## Accessories for Estetica Series

### Terminal blocks

The complete terminal blocks are composed of a combination of terminal holders and terminal bars as indicated in the description, with the terminal bars already mounted on terminal holders.

Configuration of the complete terminal block is standard. For different requirements (customized terminal block), the terminal holders and bars must be procured separately in the versions indicated in the table.



Code	Description	Box/pack No items
<b>12 492</b>	for 8 modules – composed of 12540x1 + 12531x1 + 12532x1	10/40
<b>12 495</b>	for 12 modules – composed of 12541x1 + 12532x2	10/40
<b>12 503</b>	for 18 modules – composed of 12542x1 + 12531x1 + 12534x1	10/40
<b>12 504</b>	for 24 modules – composed of 12541x2 + 12531x2 + 12533x2	10/40
<b>12 505</b>	for 36 modules – composed of 12541x2 + 12531x2 + 12534x2	10/40

### Terminal holders

RAL 7035 grey



### Terminal bars

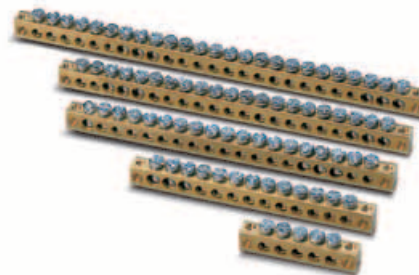

Code	Description	For consumer units type	Box/pack No items
<b>12 540</b>	for 8 modules	1SL2008A00 – 1SL2028A00 – 12 038	12/144
<b>12 541</b>	for 12 modules per row	1SL2012A00 – 1SL2032A00 – 12 042 1SL2014A00 – 1SL2034A00 – 12 044 1SL2016A00 – 1SL2036A00 – 12 046	12/144
<b>12 542</b>	for 18 modules per row	1SL2013A00 – 1SL2033A00 – 12 043	12/108

The terminal block is completed by combining the necessary terminal bars to the terminal holders, taking care to keep the terminal bars separated from each other.

Code	Description	Box/pack No items
	No of holes x Ø holes (mm) + No of holes x mm <sup>2</sup>	
<b>12 531</b>	5x16	20/240
<b>12 532</b>	10x16 + 3x25	20/240
<b>12 533</b>	16x16 + 3x25	20/240
<b>12 534</b>	15x16 + 6x25	20/240
<b>12 535</b>	19x16 + 6x25	20/240

The terminal bars can be installed on any kind of terminal holder; they are snapped onto these with 2 clips per bar, through two holes made at the ends of the bar itself.

Terminal holders and terminal bars are supplied separately. In this way, by inserting one or two terminal bars into the terminal holder you can create the best terminal for your requirements, with the advantage of obtaining a terminal block that is cheap as well as personalised, due to the fact that you only need to use material that is really necessary. Some standard configurations are illustrated in the table.

All the possible configurations that can be created for each type of consumer unit are given in the technical details.

# IP 40 flush-mounting consumer units

## Accessories for Estetica Series

### Module covers

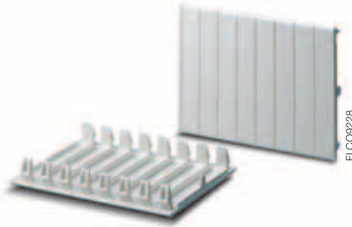

Code	Colour	No modules	Box/pack No items
<b>1SL2857A00</b>	RAL 9016 white	1	50/1500
<b>1SL2859A00</b>	RAL 9016 white	4	25/300
<b>12 895</b>	RAL 7021 grey	1	50/1500
<b>12 896</b>	RAL 7021 grey	4	25/300

### Aesthetic covers



Code	Colour	Box/pack No items
<b>1SL2868A00</b>	RAL 9016 white (pair)	10/120
<b>12 869</b>	RAL 7021 grey (pair)	10/120

### Spare doors



Transparent smoky	RAL 9016 white opaque	For consumer units type	Box/pack No items
<b>12 051</b>	<b>1SL2047A00</b>	1SL2024A00 – 12 037	1/80
<b>12 053</b>	<b>1SL2049A00</b>	1SL2028A00 – 12 038	1/50
<b>12 055</b>	<b>1SL2050A00</b>	1SL2032A00 – 12 042 1SL2034A00 – 12 044 1SL2036A00 – 12 046	1/50
<b>12 060</b>	<b>1SL2056A00</b>	1SL2033A00 – 12 043	1/50

### Screw lead sealing accessory



Code	Box/pack No items
<b>12 860</b>	50/1500

### Plastered panel box - GWT 850 °C



Code	Description	Box/pack No items
<b>1SL0527A00</b>	8 modules	1/18
<b>1SL0528A00</b>	12 modules	1/14
<b>1SL0529A00</b>	24 modules	1/8

Complete with assembly accessories



Residential application



FLC09602



# IP 40 flush-mounting consumer units

## Europa Series

### Technical characteristics

- protection degree IP 40
- insulation class II 
- available in 2 versions: with opaque door and with transparent, smoky door both with vertical hinge
- available in the following material:
  - RAL 9016 white and RAL 7035 grey thermoplastic, self-extinguishing and resistant to abnormal heat and fire up to 650 °C (glow wire flammability index) in compliance with IEC 60695-2-11 Standard
- installation temperature from -15 °C to +60 °C
- resistant to heat: ball thermopressure up to +85 °C in compliance with EN 60695-10-2 Standard
- shock resistance 6 Joules
- door designed to be fitted with a pin lock code 12 867
- flush-mounting enclosure with push-in inlet for entrance of protective corrugated conduits
- extractable DIN rail frame to facilitate bench cabling
- consumer units manufactured to compensate possible defects during the installation (thanks to slots at the points where the front parts are hooked on)
- consumer units manufactured in compliance with CEI 23-49 (1996) + V1 + V2, CB certificate IEC 60670-24 Standards
- consumer units are supplied complete with:
  - module covers
  - 1 self-adhesive indicator strip per row
  - 1 plate for CEI 23-51 certification
  - instruction sheet
- to meet the installation needs of flush-mounting consumer units, separate codes are available for the flush-mounting box with terminal bars.
- consumer units are RoHS compliance and Halogen free (excluded plastered box).

2



# IP 40 flush-mounting consumer units

## Europa Series

8 modules

12 modules

24 modules

With opaque vertically hinged door

RAL 9016 white / RAL 7035 grey

2



Code	Colour	Dimensions (mm) WxHxD	Box/pack No items
<b>1SL2040A00</b>	white	230x190x90	1/14
<b>1SL2040A06</b>	white with terminal bars	230x190x90	1/14
<b>12 026</b>	grey	230x190x90	1/14
Flush-mounting box			
<b>1SL0521A00</b>		215x183x73	1/18
Front			
<b>1SL0563A00</b>	white	230x190x18	1/18

Code	Colour	Dimensions (mm) WxHxD	Box/pack No items
<b>1SL2041A00</b>	white	300x180x90	1/10
<b>1SL2041A06</b>	white with terminal bars	300x180x90	1/10
<b>12 027</b>	grey	300x180x90	1/10
Flush-mounting box			
<b>1SL0522A00</b>		284x183x73	1/14
Front			
<b>1SL0564A00</b>	white	300x180x18	1/14

Code	Colour	Dimensions (mm) WxHxD	Box/pack No items
<b>1SL2045A00</b>	white	300x395x90	1/5
<b>1SL2045A13</b>	white with terminal bars	300x395x90	1/5
<b>12 030</b>	grey	300x395x90	1/5
Flush-mounting box			
<b>1SL0524A00</b>		280x370x80	1/4
Front			
<b>1SL0565A00</b>	white	300x395x12	1/4

With transparent, smoky vertically hinged door

RAL 9016 white / RAL 7035 grey



Code	Colour	Dimensions (mm) WxHxD	Box/pack No items
<b>1SL2057A00</b>	white	230x180x90	1/14
<b>1SL2057A06</b>	white with terminal bars	230x180x90	1/14
<b>12 058</b>	grey	230x180x90	1/14
Flush-mounting box			
<b>1SL0521A00</b>		215x183x73	1/18
Front			
<b>1SL0566A00</b>	white	230x180x18	1/18

Code	Colour	Dimensions (mm) WxHxD	Box/pack No items
<b>1SL2061A00</b>	white	300x180x90	1/10
<b>1SL2061A06</b>	white with terminal bars	300x180x90	1/10
<b>12 062</b>	grey	300x180x90	1/10
Flush-mounting box			
<b>1SL0522A00</b>		284x183x73	1/14
Front			
<b>1SL0567A00</b>	white	300x180x18	1/14

Code	Colour	Dimensions (mm) WxHxD	Box/pack No items
<b>1SL2063A00</b>	white	300x395x90	1/5
<b>1SL2063A13</b>	white with terminal bars	300x395x90	1/5
<b>12 064</b>	grey	300x395x90	1/5
Flush-mounting box			
<b>1SL0524A00</b>		280x370x80	1/4
Front			
<b>1SL0568A00</b>	white	300x395x12	1/4

# IP 40 flush-mounting consumer units

## Europa Series

36 modules

54 modules

### With opaque vertically hinged door

RAL 9016 white / RAL 7035 grey



Code	Colour	Dimensions (mm) WxHxD	Box/pack No items
<b>1SL2048A00</b>	white	300x545x90	1/3
<b>1SL2048A14</b>	white with terminal bars	300x545x90	1/3
<b>12 031</b>	grey	300x545x90	1/3

Code	Colour	Dimensions (mm) WxHxD	Box/pack No items
<b>1SL2052A00</b>	white	410x545x90	1/1
<b>1SL2052A06</b>	white with terminal bars	410x545x90	1/1
<b>12 035</b>	grey	410x545x90	1/1

### With transparent, smoky vertically hinged door

RAL 9016 white / RAL 7035 grey



Code	Colour	Dimensions (mm) WxHxD	Box/pack No items
<b>1SL2065A00</b>	white	300x545x90	1/3
<b>1SL2065A14</b>	white with terminal bars	300x545x90	1/3
<b>12 066</b>	grey	300x545x90	1/3

Code	Colour	Dimensions (mm) WxHxD	Box/pack No items
<b>1SL2067A00</b>	white	410x545x90	1/1
<b>1SL2067A06</b>	white with terminal bars	410x545x90	1/1
<b>12 068</b>	grey	410x545x90	1/1

### Terminal bars configuration

No modules	N (holes x mm <sup>2</sup> )	PE (holes x mm <sup>2</sup> )
8	(10 x 16) + (3 x 25)	(5 x 16)
12	(10 x 16) + (3 x 25)	(10 x 16) + (3 x 25)
24	(16 x 16) + (3 x 25)	(16 x 16) + (3 x 25)
36	(15 x 16) + (6 x 25)	(15 x 16) + (6 x 25)
54	(19 x 16) + (6 x 25)	(19 x 16) + (6 x 25)

# IP 40 flush-mounting consumer units

## Accessories for Europa Series

### Terminal blocks

The complete terminal blocks are composed of a combination of terminal holders and terminal bars as indicated in the description, with the terminal bars already mounted on terminal holders.

Configuration of the complete terminal block is standard. For different requirements (customized terminal block), the terminal holders and bars must be procured separately in the versions indicated in the table.

2



Code	Description	Box/pack No items
<b>12 492</b>	for 8 modules – composed of 12540x1 + 12531x1 + 12532x1	10/40
<b>12 495</b>	for 12 modules – composed of 12541x1 + 12532x2	10/40
<b>12 504</b>	for 24 modules – composed of 12541x2 + 12531x2 + 12533x2	10/40
<b>12 505</b>	for 36 modules – composed of 12541x2 + 12531x2 + 12534x2	10/40
<b>12 506</b>	for 54 modules – composed of 12542x2 + 12532x2 + 12535x2	5/20

### Terminal holders

RAL 7035 grey



Code	Description	For consumer units type	Box/pack No items
<b>12 540</b>	for 8 modules	1SL2040A00 – 12 026 – 1SL2057A00 – 12 058	12/144
<b>12 541</b>	for 12 modules per row	1SL2041A00 – 12 027 – 1SL2061A00 – 12 062 1SL2045A00 – 12 030 – 1SL2063A00 – 12 064 1SL2048A00 – 12 031 – 1SL2065A00 – 12 066	12/144
<b>12 542</b>	for 18 modules per row	1SL2052A00 – 12 035 – 1SL2067A00 – 12 068	12/108

The terminal block is completed by combining the necessary terminal bars to the terminal holders, taking care to keep the terminal bars separated from each other.

### Terminal bars

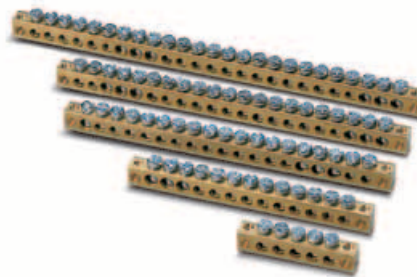

Code	Description No of holes x Ø holes (mm) + No of holes x mm <sup>2</sup>	Box/pack No items
<b>12 531</b>	5x16	20/240
<b>12 532</b>	10x16 + 3x25	20/240
<b>12 533</b>	16x16 + 3x25	20/240
<b>12 534</b>	15x16 + 6x25	20/240
<b>12 535</b>	19x16 + 6x25	20/240

The terminal bars can be installed on any kind of terminal holder; they are snapped onto these with 2 clips per bar, through two holes made at the ends of the bar itself.

Terminal holders and terminal bars are supplied separately. In this way, by inserting one or two terminal bars into the terminal holder you can create the best terminal for your requirements, with the advantage of obtaining a terminal block that is cheap as well as personalised, due to the fact that you only need to use material that is really necessary. Some standard configurations are illustrated in the table.

All the possible configurations that can be created for each type of consumer unit are given in the technical details.

# IP 40 flush-mounting consumer units

## Accessories for Europa Series

### Module covers



Code	Colour	No modules	Box/pack No items
<b>1SL2857A00</b>	RAL 9016 white	1	50/1500
<b>1SL2859A00</b>	RAL 9016 white	4	25/300
<b>12 861</b>	RAL 7035 grey	1	50/1500
<b>12 863</b>	RAL 7035 grey	4	25/300

### Lock with key



Code	Description	Box/pack No items
<b>12 867</b>	pin type	10/300

### Spare doors



Opaque		For consumer units type	Box/pack No items
white RAL 9016	grey RAL 7035		
<b>1SL2078A00</b>	<b>12 070</b>	1SL2040A00 – 12 026	1/50
<b>1SL2079A00</b>	<b>12 071</b>	1SL2041A00 – 12 027	1/50
<b>1SL2080A00</b>	<b>12 072</b>	1SL2045A00 – 12 030	1/25
<b>1SL2081A00</b>	<b>12 073</b>	1SL2048A00 – 12 031	1/10
<b>1SL2088A00</b>	<b>12 087</b>	1SL2052A00 – 12 035	1/10

### Transparent smoky

	For consumer units type	Box/pack No items
<b>12 074</b>	1SL2057A00 – 12 058	1/50
<b>12 075</b>	1SL2061A00 – 12 062	1/50
<b>12 076</b>	1SL2063A00 – 12 064	1/25
<b>12 077</b>	1SL2065A00 – 12 066	1/20
<b>12 089</b>	1SL2067A00 – 12 068	1/10

### Screw lead sealing accessory



Code	Box/pack No items
<b>12 860</b>	50/1500

### Plastered panel box - GWT 850 °C



Code	Description	Box/pack No items
<b>1SL0527A00</b>	8 modules	1/18
<b>1SL0528A00</b>	12 modules	1/14
<b>1SL0529A00</b>	24 modules	1/8

Complete with assembly accessories

Residential/tertiary application



PLC69801



# IP 40 wall-mounting consumer units

## Unibox Series

### Technical characteristics

- protection degree IP 40
- available in 3 versions: without door, with opaque door and with transparent, smoky door with vertical hinge
- available in RAL 9016 white
- in **thermoplastic**, self-extinguishing and resistant to abnormal heat and fire up to 650 °C (glow wire flammability index) in compliance with IEC 60695-2-11 Standard
- installation temperature from -25 °C to +60 °C
- resistant to heat: ball thermopressure up to +85 °C in compliance with EN 60695-10-2 Standard
- shock resistance 10 Joules (IK level 09)
- door opening with push-pull mechanism
- door designed to be fitted with a coded lock code 12 530
- base of the consumer unit fitted with a special system to cover the holes used to attach it to the wall to guarantee perfect insulation
- **extractable DIN rail frame** to facilitate bench cabling that can be angled at a fixed position to make it easier to work on the connection cables. It can also be dismantled (and snapped on to reassemble it) to make it easier to cable the individual wires. The frame can be snapped onto the base of the consumer unit without having to use any extra screws
- all the models are provided with one extra module per row that can be used by removing the 1/2 module trimmings at the ends of each row
- screws for fixing the cover in rapid pitch insulating thermoplastic material that can be lead sealed easily without extra accessories, making it possible to compensate for uneven brickwork up to 4 mm
- highest versatility in the trunking (trimming) and conduit (flange for conduits up to diameter of 40 mm) derivations
- a cable holding system guarantees safe and tidy cabling securing the input and output cables to a special accessory that protects the terminals from direct mechanical interference (excluded model with 8 modules)
- **personalised finish**, on request (bur, marble, patterned, etc.)
- consumer units manufactured in compliance with CEI 23-49 (1996) + V1 + V2, CB certificate IEC 60670-24 Standards
- components and accessories are easy to assembly by snapping on, without the need for screws
- elegant attractive line following the latest trends in design (**patented model**)
- consumer units supplied complete with:
  - module covers
  - protective film for door
  - cable-clip accessory
  - rigid flange for branch connections with conduits
  - 1 self-adhesive indicator strip per row
  - 1 plate for CEI 23-51 certification
  - instruction sheet
  - 4 protection caps
- to meet the installation needs of flush-mounting consumer units, separate codes are available for the flush-mounting box with terminal bars.

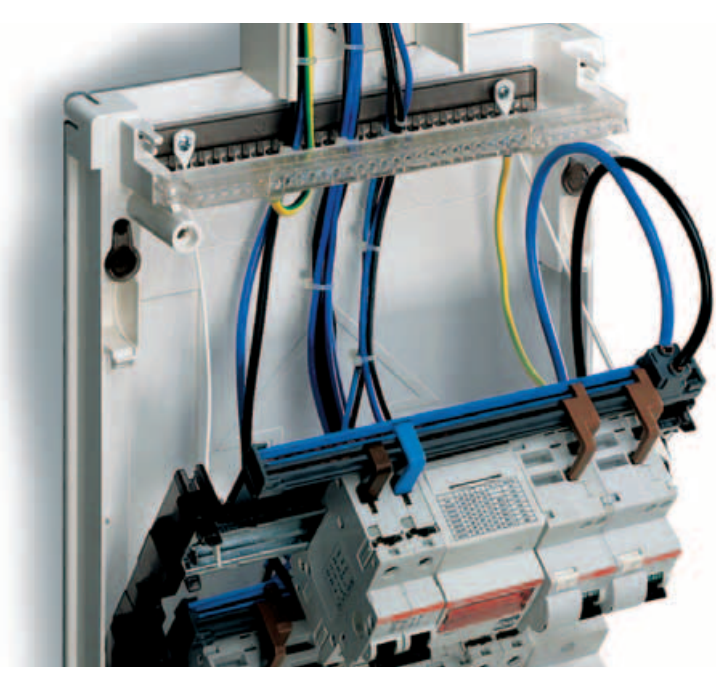

1SLC86012F1001

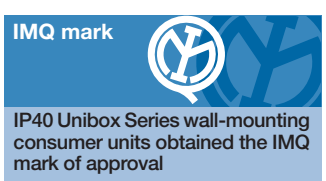

# IP 40 wall-mounting consumer units

## Unibox Series

8 modules

12 modules

24 modules

Without door

RAL 9016 white



Code	Colour	Dimensions (mm) WxHxD	Box/pack No items
<b>12 208</b>	white	215x220x105	1/9

Code	Colour	Dimensions (mm) WxHxD	Box/pack No items
<b>12 212</b>	white	295x245x115	1/7

Code	Colour	Dimensions (mm) WxHxD	Box/pack No items
<b>12 214</b>	white	295x390x115	1/5

With opaque, vertically hinged door

RAL 9016 white



Code	Colour	Dimensions (mm) WxHxD	Box/pack No items
<b>12 238</b>	white	215x220x105	1/9
<b>M12238000U</b>	white with terminal bars	215x220x105	1/9

Code	Colour	Dimensions (mm) WxHxD	Box/pack No items
<b>12 242</b>	white	295x245x115	1/7
<b>M12242000A</b>	white with terminal bars	295x245x115	1/7

Code	Colour	Dimensions (mm) WxHxD	Box/pack No items
<b>12 244</b>	white	295x390x115	1/5
<b>M12244000U</b>	white with terminal bars	295x390x115	1/5

With transparent, smoky vertically hinged door

RAL 9016 white

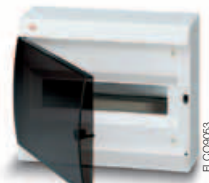

Code	Colour	Dimensions (mm) WxHxD	Box/pack No items
<b>12 258</b>	white	215x220x105	1/9
<b>M12258000U</b>	white with terminal bars	215x220x105	1/9

Code	Colour	Dimensions (mm) WxHxD	Box/pack No items
<b>12 262</b>	white	295x245x115	1/7
<b>M12262000A</b>	white with terminal bars	295x245x115	1/7

Code	Colour	Dimensions (mm) WxHxD	Box/pack No items
<b>12 264</b>	white	295x390x115	1/5
<b>M12264000U</b>	white with terminal bars	295x390x115	1/5



# IP 40 wall-mounting consumer units

## Unibox Series

### 36 modules

### 54 modules

#### Without door

RAL 9016 white



FLC09047



FLC09051

Code	Colour	Dimensions (mm) WxHxD	Box/pack No items
<b>12 216</b>	white	295x515x115	1/3

Code	Colour	Dimensions (mm) WxHxD	Box/pack No items
<b>12 217</b>	white	405x515x115	1/1

#### With opaque, vertically hinged door

RAL 9016 white



FLC09057



FLC09061

Code	Colour	Dimensions (mm) WxHxD	Box/pack No items
<b>12 246</b>	white	295x515x115	1/3
<b>M12246000U</b>	white with terminal bars	295x515x115	1/3

Code	Colour	Dimensions (mm) WxHxD	Box/pack No items
<b>12 247</b>	white	405x515x115	1/1
<b>M12247000U</b>	white with terminal bars	405x515x115	1/3

#### With transparent, smoky vertically hinged door

RAL 9016 white



FLC09055



FLC09056

Code	Colour	Dimensions (mm) WxHxD	Box/pack No items
<b>12 266</b>	white	295x515x115	1/3
<b>M12266000U</b>	white with terminal bars	295x515x115	1/3

Code	Colour	Dimensions (mm) WxHxD	Box/pack No items
<b>12 267</b>	white	405x515x115	1/1
<b>M12267000U</b>	white with terminal bars	405x515x115	1/1

#### Terminal bars configuration

No modules	N (holes x mm <sup>2</sup> )
8	(10 x 16) + (3 x 25)
12	(10 x 16) + (3 x 25)
24	(16 x 16) + (3 x 25) + (5 x 16)
36	(15 x 16) + (6 x 25) + (5 x 16)
54	(19 x 16) + (6 x 25)

No modules	PE (holes x mm <sup>2</sup> )
8	(5 x 16)
12	(10 x 16) + (3 x 25)
24	(16 x 16) + (3 x 25) + (5 x 16)
36	(15 x 16) + (6 x 25) + (5 x 16)
54	(19 x 16) + (6 x 25)

# IP 40 wall-mounting consumer units

## Accessories for Unibox Series

### Terminal blocks

The complete terminal blocks are composed of a combination of terminal holders and terminal bars as indicated in the description, with the terminal bars already mounted on terminal holders.

Configuration of the complete terminal block is standard. For different requirements (customized terminal block), the terminal holders and bars must be procured separately in the versions indicated in the table.

2

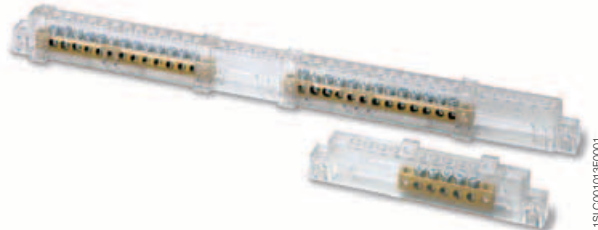

Code	Description	Box/pack No items
<b>12 492</b>	for 8 modules – composed of 12540x1 + 12531x1 + 12532x1	10/40
<b>12 495</b>	for 12 modules – composed of 12541x1 + 12532x2	10/40
<b>12 504</b>	for 24 modules – composed of 12541x2 + 12531x2 + 12533x2	10/40
<b>12 505</b>	for 36 modules – composed of 12541x2 + 12531x2 + 12534x2	10/40
<b>12 501</b>	for 54 modules – composed of 12542x2 + 12535x2	5/20

### Terminal-holders

RAL 7035 grey



### Terminal bars

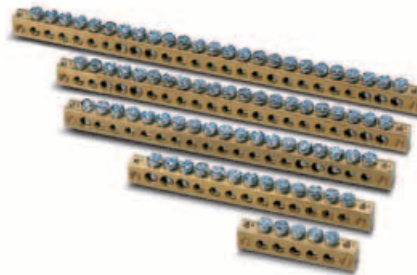

Code	Description	For consumer units type	Box/pack No items
<b>12 540</b>	for 8 modules	12 208 – 12 228 – 12 238	12/144
		12 248 – 12 258 – 12 268	
<b>12 541</b>	for 12 modules per row	12 212 – 12 232 – 12 242	12/144
		12 252 – 12 262 – 12 272	
		12 214 – 12 234 – 12 244	
		12 254 – 12 264 – 12 274	
		12 216 – 12 236 – 12 246	
		12 256 – 12 266 – 12 276	
<b>12 542</b>	for 18 modules per row	12 217 – 12 237 – 12 247	12/108
		12 257 – 12 267 – 12 277	

Code	Description No of holes x Ø holes (mm) + No of holes x mm <sup>2</sup>	Box/pack No items
<b>12 531</b>	5x16	20/240
<b>12 532</b>	10x16 + 3x25	20/240
<b>12 533</b>	16x16 + 3x25	20/240
<b>12 534</b>	15x16 + 6x25	20/240
<b>12 535</b>	19x16 + 6x25	20/240

The terminal bars can be installed on any kind of terminal holder; they are snapped onto these with 2 clips per bar, through two holes made at the ends of the bar itself.

The terminal block is completed by combining the necessary terminal bars to the terminal holders, taking care to keep the terminal bars separated from each other.

Terminal holders and terminal bars are supplied separately. In this way, by inserting one or two terminal bars into the terminal holder you can create the best terminal for your requirements, with the advantage of obtaining a terminal block that is cheap as well as personalised, due to the fact that you only need to use material that is really necessary. Some standard configurations are illustrated in the table.

All the possible configurations that can be created for each type of consumer unit are given in the technical details.

# IP 40 wall-mounting consumer units

## Accessories for Unibox Series

### Spare doors



FLC09277

#### Opaque

white RAL 9016	For consumer units type	Box/pack No items
<b>12 511</b>	12 238	1/25
<b>12 512</b>	12 242	1/15
<b>12 513</b>	12 244	1/10
<b>12 514</b>	12 246	1/5
<b>12 515</b>	12 247	1/5

#### Transparent smoky

	For consumer units type	Box/pack No items
<b>12 521</b>	12 258 – 12 268	1/25
<b>12 522</b>	12 262 – 12 272	1/15
<b>12 523</b>	12 264 – 12 274	1/10
<b>12 524</b>	12 266 – 12 276	1/5
<b>12 525</b>	12 267 – 12 277	1/5

The mechanism for push-pull code No 12 526 (in packs of 5 items) should be always ordered with each door.

### Lock with key



FLC09274

Code	Description	Box/pack No items
<b>12 530</b>	coded type	20/300

2

### Module covers



FLC09118

Code	Colour	No modules	Box/pack No items
<b>1SL2857A00</b>	RAL 9016 white	1	50/1500
<b>1SL2859A00</b>	RAL 9016 white	4	25/300

### Coupling element

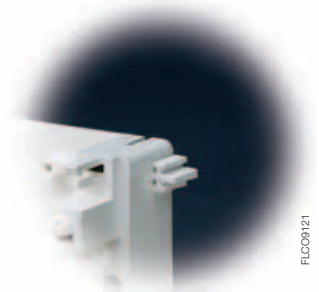

FLC09121

Code	Box/pack No items
<b>12 556</b>	10/100

### Cable-clip accessory

Not available for consumer units with 8 modules

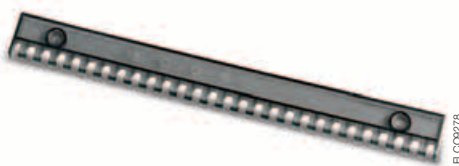

FLC09278

Code	Box/pack No items
<b>12 550</b>	1/30

Residential/tertiary application



FLC09803

# IP 40 wall-mounting consumer units

## Europa Series

### Technical characteristics

- protection degree IP 40
- insulation class II 
- available in 3 versions: without door, with opaque door and with transparent, smoky door with vertical hinge
- available in the following material:
  - RAL 9016 white and RAL 7035 grey thermoplastic, self-extinguishing and resistant to abnormal heat and fire up to 650 °C (glow wire flammability index) in compliance with IEC 60695-2-11 Standard
- installation temperature from -25 °C to +60 °C
- resistant to heat: ball thermopressure up to +85 °C in compliance with EN 60695-10-2 Standard
- shock resistance 6 Joules
- symmetrical, reversible door to open on either sides, designed to be fitted with a coded lock code 12 864
- front part designed for input of cable trunking measuring up to 200x60 mm; possibility of branch connection with conduit thanks to a flange included in the supply
- consumer units designed with roomy interiors to make cabling easy and tidy
- devices with a depth of 53 and 68 mm can be installed on switchboxes with 8, 12, 24 modules and devices with a depth of up to 75 mm on consumer units with 36-54 modules
- consumer units manufactured in compliance with CEI 23-49 (1996) + V1 + V2, CB certificate IEC 60670-24 Standards
- consumer units are supplied complete with:
  - module covers
  - 1 rigid flange for branch connection with conduit
  - 1 self-adhesive indicator strip per row
  - 1 plate for CEI 23-51 certification
  - instruction sheet
  - 4 protection caps
- to meet the installation needs of flush-mounting consumer units, separate codes are available for the flush-mounting box with terminal bars.

2





# IP 40 wall-mounting consumer units

## Europa Series

8 modules

12 modules

24 modules

Without door

RAL 9016 white / RAL 7035 grey



Code	Colour	Dimensions (mm) WxHxD	Box/pack No items
<b>1SL2408A00</b>	white	230x200x95	1/12
<b>12 428</b>	grey	230x200x95	1/12

Code	Colour	Dimensions (mm) WxHxD	Box/pack No items
<b>1SL2412A00</b>	white	305x200x95	1/10
<b>12 432</b>	grey	305x200x95	1/10

Code	Colour	Dimensions (mm) WxHxD	Box/pack No items
<b>1SL2414A00</b>	white	305x350x95	1/6
<b>12 434</b>	grey	305x350x95	1/6

With opaque, vertically hinged door

RAL 9016 white / RAL 7035 grey



Code	Colour	Dimensions (mm) WxHxD	Box/pack No items
<b>1SL2438A00</b>	white	230x200x95	1/12
<b>1SL2438A06</b>	white with terminal bars	230x200x95	1/12
<b>12 448</b>	grey	230x200x95	1/12

Code	Colour	Dimensions (mm) WxHxD	Box/pack No items
<b>1SL2442A00</b>	white	305x200x95	1/10
<b>1SL2442A06</b>	white with terminal bars	305x200x95	1/10
<b>12 452</b>	grey	305x200x95	1/10

Code	Colour	Dimensions (mm) WxHxD	Box/pack No items
<b>1SL2444A00</b>	white	305x350x95	1/6
<b>1SL2444A13</b>	white with terminal bars	305x350x95	1/6
<b>12 454</b>	grey	305x350x95	1/6

With transparent, smoky vertically hinged door

RAL 9016 white / RAL 7035 grey



Code	Colour	Dimensions (mm) WxHxD	Box/pack No items
<b>1SL2458A00</b>	white	230x200x95	1/12
<b>1SL2458A06</b>	white with terminal bars	230x200x95	1/12
<b>12 468</b>	grey	230x200x95	1/12

Code	Colour	Dimensions (mm) WxHxD	Box/pack No items
<b>1SL2462A00</b>	white	305x200x95	1/10
<b>1SL2462A06</b>	white with terminal bars	305x200x95	1/10
<b>12 472</b>	grey	305x200x95	1/10

Code	Colour	Dimensions (mm) WxHxD	Box/pack No items
<b>1SL2464A00</b>	white	305x350x95	1/6
<b>1SL2464A13</b>	white with terminal bars	305x350x95	1/6
<b>12 474</b>	grey	305x350x95	1/6



# IP 40 wall-mounting consumer units

## Europa Series

### 36 modules

### 54 modules

#### Without door

RAL 9016 white / RAL 7035 grey



Code	Colour	Dimensions (mm) WxHxD	Box/pack No items
<b>1SL2416A00</b>	white	305x545x120	1/3
<b>12 436</b>	grey	305x545x120	1/3

Code	Colour	Dimensions (mm) WxHxD	Box/pack No items
<b>1SL2417A00</b>	white	380x570x120	1/2
<b>12 437</b>	grey	380x570x120	1/2

#### With opaque, vertically hinged door

RAL 9016 white / RAL 7035 grey



Code	Colour	Dimensions (mm) WxHxD	Box/pack No items
<b>1SL2446A00</b>	white	305x545x120	1/3
<b>1SL2446A14</b>	white with terminal bars	305x545x120	1/3
<b>12 456</b>	grey	305x545x120	1/3

Code	Colour	Dimensions (mm) WxHxD	Box/pack No items
<b>1SL2447A00</b>	white	380x570x120	1/2
<b>1SL2447A07</b>	white with terminal bars	380x570x120	1/2
<b>12 457</b>	grey	380x570x120	1/2

#### With transparent, smoky vertically hinged door

RAL 9016 white / RAL 7035 grey



Code	Colour	Dimensions (mm) WxHxD	Box/pack No items
<b>1SL2466A00</b>	white	305x545x120	1/3
<b>1SL2466A14</b>	white with terminal bars	305x545x120	1/3
<b>12 476</b>	grey	305x545x120	1/3

Code	Colour	Dimensions (mm) WxHxD	Box/pack No items
<b>1SL2467A00</b>	white	380x570x120	1/2
<b>1SL2467A07</b>	white with terminal bars	380x570x120	1/2
<b>12 477</b>	grey	380x570x120	1/2

#### Terminal bars configuration

No modules	N (holes x mm <sup>2</sup> )
8	(10 x 16) + (3 x 25)
12	(10 x 16) + (3 x 25)
24	(16 x 16) + (3 x 25)
36	(15 x 16) + (6 x 25)
54	(19 x 16) + (6 x 25)

No modules	PE (holes x mm <sup>2</sup> )
8	(5 x 16)
12	(10 x 16) + (3 x 25)
24	(16 x 16) + (3 x 25)
36	(15 x 16) + (6 x 25)
54	(19 x 16) + (6 x 25)

# IP 40 wall-mounting consumer units

## Accessories for Europa Series

### Terminal blocks

The complete terminal blocks are composed of a combination of terminal holders and terminal bars as indicated in the description, with the terminal bars already mounted on terminal holders.

Configuration of the complete terminal block is standard. For different requirements (customized terminal block), the terminal holders and bars must be procured separately in the versions indicated in the table.

2



Code	Description	Box/pack No items
<b>12 492</b>	for 8 modules – composed of 12540x1 + 12531x1 + 12532x1	10/40
<b>12 495</b>	for 12 modules – composed of 12541x1 + 12532x2	10/40
<b>12 504</b>	for 24 modules – composed of 12541x2 + 12531x2 + 12533x2	10/40
<b>12 505</b>	for 36 modules – composed of 12541x2 + 12531x2 + 12534x2	10/40
<b>12 497</b>	for 54 modules – composed of 12543x2 + 12535x2	10/40

### Terminal holders



### Terminal bars

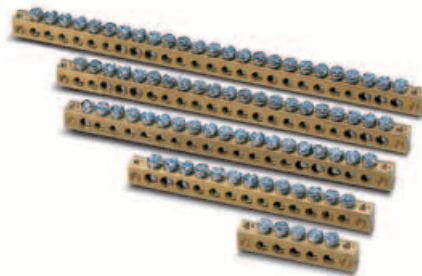

Code	Description	For consumer units type	Box/pack No items
<b>12 540</b>	for 8 modules	1SL2408A00 – 12 428 – 1SL2438A00	12/144
		12 448 – 1SL2458A00 – 12 468	
<b>12 541</b>	for 12 modules per row	1SL2412A00 – 12 432 – 1SL2442A00	12/144
		12 452 – 1SL2462A00 – 12 472	
		1SL2414A00 – 12 434 – 1SL2444A00	
		12 454 – 1SL2464A00 – 12 474	
		1SL2416A00 – 12 436 – 1SL2446A00	
<b>12 543</b>	for 18 modules per row	1SL2417A00 – 12 437 – 1SL2447A00	12/108
		12 457 – 1SL2467A00 – 12 477	

Code	Description No of holes x Ø holes (mm) + No of holes x mm <sup>2</sup>	Box/pack No items
<b>12 531</b>	5x16	20/240
<b>12 532</b>	10x16 + 3x25	20/240
<b>12 533</b>	16x16 + 3x25	20/240
<b>12 534</b>	15x16 + 6x25	20/240
<b>12 535</b>	19x16 + 6x25	20/240

The terminal bars can be installed on any kind of terminal holder; they are snapped onto these with 2 clips per bar, through two holes made at the ends of the bar itself.

The terminal block is completed by combining the necessary terminal bars to the terminal holders, taking care to keep the terminal bars separated from each other.

Terminal holders and terminal bars are supplied separately. In this way, by inserting one or two terminal bars into the terminal holder you can create the best terminal for your requirements, with the advantage of obtaining a terminal block that is cheap as well as personalised, due to the fact that you only need to use material that is really necessary. Some standard configurations are illustrated in the table.

All the possible configurations that can be created for each type of consumer unit are given in the technical details.

# IP 40 wall-mounting consumer units

## Accessories for Europa Series

### Spare doors



FLCO9234

Opaque		For consumer units type	Box/pack No items
white RAL 9016	grey RAL 7035		
<b>1SL2078A00</b>	<b>12 070</b>	1SL2438A00 – 12 448	1/50
<b>1SL2079A00</b>	<b>12 071</b>	1SL2442A00 – 12 452	1/50
<b>1SL2080A00</b>	<b>12 072</b>	1SL2444A00 – 12 454	1/25
<b>1SL2081A00</b>	<b>12 073</b>	1SL2446A00 – 12 456	1/10
<b>1SL2095A00</b>	<b>12 094</b>	1SL2447A00 – 12 457	1/10

### Transparent smoky

	For consumer units type	Box/pack No items
<b>12 074</b>	1SL2458A00 – 12 468	1/50
<b>12 075</b>	1SL2462A00 – 12 472	1/50
<b>12 076</b>	1SL2464A00 – 12 474	1/25
<b>12 077</b>	1SL2466A00 – 12 476	1/20
<b>12 096</b>	1SL2467A00 – 12 477	1/10

### Lock with key

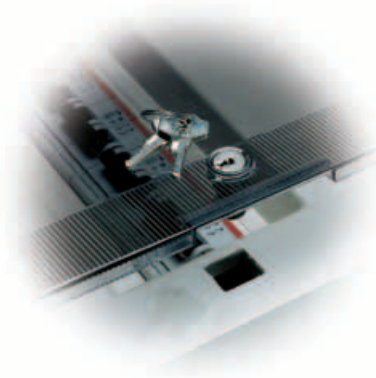

FLCO9233

Code	Description	Box/pack No items
<b>12 864</b>	coded type	10/300

### Module covers

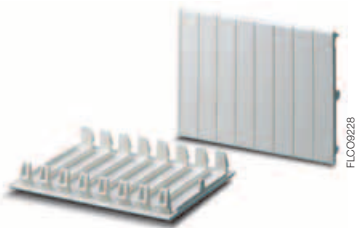

FLCO9228

Code	Colour	No modules	Box/pack No items
<b>1SL2857A00</b>	RAL 9016 white	1	50/1500
<b>1SL2859A00</b>	RAL 9016 white	4	25/300
<b>12 861</b>	RAL 7035 grey	1	50/1500
<b>12 863</b>	RAL 7035 grey	4	25/300

### Screw lead sealing accessory



1SLCO01014F001

Code	Box/pack No items
<b>12 860</b>	50/1500

Residential/tertiary applications



FLOORSB7

# IP 40 wall-mounting consumer units

## Europa Polycarbonate Series

### Technical characteristics

- protection degree IP 40
- insulation class II
- available in self-extinguishing polycarbonate resistant to abnormal heat and fire up to 960 °C (glow wire flammability index) in compliance with IEC 60695-2-11 Standard
- available in RAL 7035 grey
- installation temperature from -25 °C to +60 °C
- resistant to heat: ball thermopressure up to +125 °C
- shock resistance 20 Joules (IK level 10)
- extractable DIN rail frame to facilitate bench cabling. It can also be dismantled (and snapped on to reassemble it) to make it easier to cable the individual wires
- possibility of installing devices with depth of 53, 68 and 75 mm
- models with 8 modules and more fitted with one rigid and one bi-material flange for facilitate input of conduits and cables
- models with 8 modules and more designed for the use of the UNIFIX L fast-cabling system
- consumer units manufactured in compliance with CEI 23-49 (1996) + V1 + V2, CB certificate IEC 60670-24 Standards
- consumer units are supplied complete with:
  - module covers
  - 1 self-adhesive indicator strip per row
  - 1 plate for CEI 23-51 certification
  - 4 screw-cover caps for guarantee
  - instruction sheet

2



IMQ mark



IP40 Europa Polycarbonate Series wall-mounting consumer units obtained the IMQ mark of approval

# IP 40 wall-mounting consumer units

## Europa Polycarbonate Series

2-4 modules

4 modules

8 modules

12 modules

Without door

RAL 7035 grey

2



FL009085



FL009082



FL009083



FL009084

Code	Dimensions (mm) WxHxD	Box/pack No items
<b>12 702</b>	105x175x85	1/36

Code	Dimensions (mm) WxHxD	Box/pack No items
<b>12 704</b>	140x220x110	1/19

Code	Dimensions (mm) WxHxD	Box/pack No items
<b>12 708</b>	205x220x110	1/9

Code	Dimensions (mm) WxHxD	Box/pack No items
<b>12 712</b>	275x220x110	1/7



# IP 40 wall-mounting consumer units

## Europa Polycarbonate Series

24 modules

36 modules

54 modules

Without door

RAL 7035 grey



Code	Dimensions (mm) WxHxD	Box/pack No items
<b>12 714</b>	275x370x110	1/5

Code	Dimensions (mm) WxHxD	Box/pack No items
<b>12 716</b>	275x570x110	1/3

Code	Dimensions (mm) WxHxD	Box/pack No items
<b>12 718</b>	380x570x120	1/2

2

# IP 40 wall-mounting consumer units

## Accessories for Europa Polycarbonate Series

### Terminal blocks

The complete terminal blocks are composed of a combination of terminal holders and terminal bars as indicated in the description, with the terminal bars already mounted on terminal holders.

Configuration of the complete terminal block is standard. For different requirements (customized terminal block), the terminal holders and bars must be procured separately in the versions indicated in the table.

2

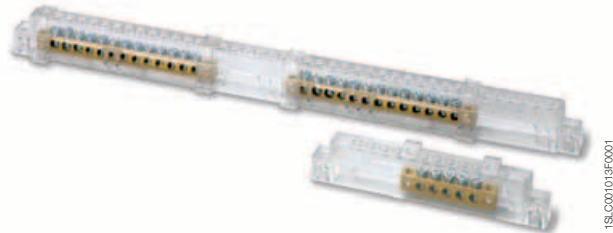

Code	Description	Box/pack No items
<b>12 490</b>	for 4 modules – composed of 12538x2 + 12531x2	10/60
<b>12 491</b>	for 8 modules – composed of 12539x2 + 12531x2	10/60
<b>12 492</b>	for 12 modules – composed of 12540x1 + 12531x1 + 12532x1	10/40
<b>12 494</b>	for 24 modules – composed of 12540x2 + 12533x2	10/40
<b>12 493</b>	for 36 modules (3 rows) – composed of 12540x2 + 12534x2	10/40
<b>12 497</b>	for 54 modules – composed of 12543x2 + 12535x2	10/40

### Terminal holders



### Terminal bars

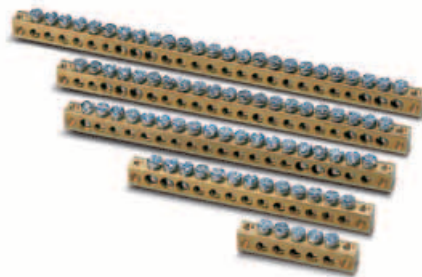

Code	Description	For consumer units type	Box/pack No items
<b>12 538</b>	for 4 modules	12 704	12/360
<b>12 539</b>	for 8 modules	12 708	12/360
<b>12 540</b>	for 12 modules per row	12 712 – 12 714 – 12 716	12/144
<b>12 543</b>	for 18 modules per row	12 718	12/144

Code	Description No of holes x Ø holes (mm) + No of holes x mm²	Box/pack No items
<b>12 531</b>	5x16	20/240
<b>12 532</b>	10x16 + 3x25	20/240
<b>12 533</b>	16x16 + 3x25	20/240
<b>12 534</b>	15x16 + 6x25	20/240
<b>12 535</b>	19x16 + 6x25	20/240

The terminal block is completed by combining the necessary terminal bars to the terminal holders, taking care to keep the terminal bars separated from each other.

The terminal bars can be installed on any kind of terminal holder; they are snapped onto these with 2 clips per bar, through two holes made at the ends of the bar itself.

Terminal holders and terminal bars are supplied separately. In this way, by inserting one or two terminal bars into the terminal holder you can create the best terminal for your requirements, with the advantage of obtaining a terminal block that is cheap as well as personalised, due to the fact that you only need to use material that is really necessary. Some standard configurations are illustrated in the table.

All the possible configurations that can be created for each type of consumer unit are given in the technical details.

# IP 40 wall-mounting consumer units

## Accessories for Europa Polycarbonate Series

### Module covers

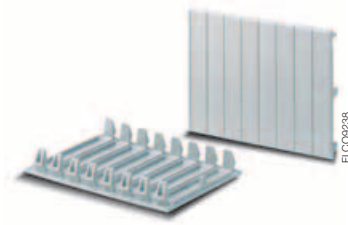

Code	Colour	No modules	Box/pack No items
<b>12 861</b>	RAL 7035 grey	1	50/1500
<b>12 863</b>	RAL 7035 grey	4	25/300

### Wall brackets



Code	Description	Box/pack No items
<b>12 858</b>	in insulating material	20/240

### Screw lead sealing accessory



Code	Box/pack No items
<b>12 860</b>	50/1500

### Semi-flush-mounting frames



Code	For consumer units type	Box/pack No items
<b>12 590</b>	12 704	5/20
<b>12 591</b>	12 708	5/20
<b>12 592</b>	12 712	5/20
<b>12 593</b>	12 714	5/20
<b>12 594</b>	12 716	5/5
<b>12 595</b>	12 718	5/5

### Spare flanges

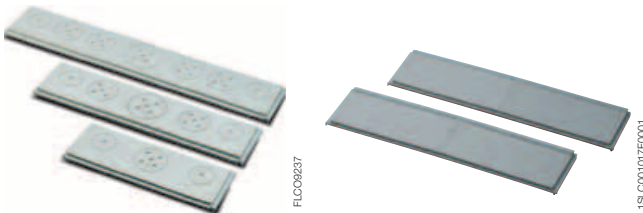

Code	For consumer units with	Box/pack No items
<b>12 600</b>	8 modules, bi-material	30/120
<b>12 601</b>	12, 24, 36 (12x3 rows) modules, bi-material	20/80
<b>12 602</b>	54 modules, bi-material	20/80
<b>1SL0550A00</b>	rigid flange 8 modules per row	30/120
<b>1SL0551A00</b>	rigid flange 12 modules per row	20/80
<b>1SL0552A00</b>	rigid flange 18 modules per row	20/80

Residential/tertiary applications



FL000862

# IP 40 wall-mounting consumer units

## Wall-mounting covers

### Technical characteristics

- protection degree IP 40
- available in material:
  - thermoplastic RAL 9016 white and RAL 7035 grey self-extinguishing and resistant to abnormal heat and fire up to 650 °C (glow wire flammability index) in compliance with IEC 60695-2-11 Standard
- installation temperature from -25 °C to +60 °C
- resistant to heat: ball thermopressure up to +85 °C in compliance with EN 60695-10-2 Standard
- shock resistance 6 Joules
- covers produced in compliance with CEI 23-49 (1996) + V1 + V2, CB certificate IEC 60670-24 Standards



IMQ mark 

IP 40 wall-mounting covers units obtained the IMQ mark of approval

# IP 40 wall-mounting consumer units

## Wall-mounting covers

2 modules

4 modules

6 modules

Without door

RAL 9016 white - RAL 7035 grey



Code	Colour	Dimensions (mm) WxHxD	Box/pack No items
<b>1SL2402A00</b>	white	50x140x65	1/45
<b>12 422</b>	grey	50x140x65	1/45

Code	Colour	Dimensions (mm) WxHxD	Box/pack No items
<b>1SL2404A00</b>	white	95x160x65	1/20
<b>12 424</b>	grey	95x160x65	1/20

Code	Colour	Dimensions (mm) WxHxD	Box/pack No items
<b>1SL2406A00</b>	white	140x160x65	1/12
<b>12 426</b>	grey	140x160x65	1/12



# IP 40 wall-mounting consumer units

## Accessories for wall-mounting covers

### Terminal bars



Code	Description No of holes x Ø holes (mm) + No of holes x mm²	For covers type	Box/pack No items
<b>12 502</b>	2x16 + 3x25	12 404 -12 406 12 424 -12 426	25/750

The terminal bar can be fixed to covers using the supplied screws.

### Module covers



Code	Colour	No modules	Box/pack No items
<b>1SL2857A00</b>	RAL 9016 white	1	50/1500
<b>1SL2859A00</b>	RAL 9016 white	4	25/300
<b>12 861</b>	RAL 7035 grey	1	50/1500
<b>12 863</b>	RAL 7035 grey	4	25/300

### Screw lead sealing accessory



Code	Box/pack No items
<b>12 860</b>	50/1500

Residential/tertiary application



FLC09806

# IP 55 wall-mounting consumer units

## IP 55 Europa Series

### Technical characteristics

- protection degree IP 55
- insulation class II 
- available with transparent, smoky horizontally hinged door in the version with sealable spring closure
- available in RAL 7035 grey
- available in thermoplastic self-extinguishing material resistant to abnormal heat and fire up to 650 °C (glow wire flammability index) in compliance with IEC 60695-2-11 Standard
- installation temperature from -25 °C to +60 °C
- resistant to heat: ball thermopressure up to +85 °C in compliance with EN 60695-10-2 Standard
- shock resistance 6 Joules
- 10 and 20 module consumer units can be attached to the wall with brackets code 12 858
- consumer units made and produced in compliance with CEI 23-49 (1996) + V1 + V2, CB certificate IEC 60670-24 Standards
- consumer units are supplied complete with:
  - module covers
  - 1 plate for CEI 23-51 certification
  - 4 protection caps



FLCO9688

# IP 55 wall-mounting consumer units

## IP 55 Europa Series

### 4 modules

### 6 modules

### 10 modules

Spring closing

RAL 7035 grey

2

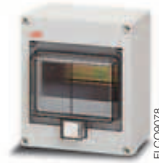

Code	Dimensions (mm) WxHxD	Box/pack No items
<b>12 644</b>	125x180x105	1/18

Code	Dimensions (mm) WxHxD	Box/pack No items
<b>12 646</b>	160x180x105	1/12

Code	Dimensions (mm) WxHxD	Box/pack No items
<b>12 650</b>	230x180x105	1/10

### 20 modules

### 10 special modules

Spring closing

RAL 7035 grey



Code	Dimensions (mm) WxHxD	Box/pack No items
<b>12 652</b>	250x320x139	1/6

Code	Dimensions (mm) WxHxD	Box/pack No items
<b>12 654</b>	250x320x139	1/6

# IP 55 wall-mounting consumer units

## Accessories for IP 55 Europa Series

### Terminal blocks



Code	Neutral terminal blocks No of holes x Ø holes (mm) + No of holes x mm <sup>2</sup>	Description No of holes x Ø holes (mm) + No of holes x mm <sup>2</sup>	Earth terminal blocks No of holes x Ø holes (mm) + No of holes x mm <sup>2</sup>	For consumer units type	Box/pack No items
<b>12 880</b>	2x16 + 3x25		2x16 + 3x25	12 644 –12 684	10/60
<b>12 882</b>	6x16 + 5x25		2x16 + 3x25	12 646 –12 686	10/60
<b>12 884</b>	6x16 + 5x25		2x16 + 3x25	12 650 –12 690	10/40
<b>12 886</b>	2 (6x16 + 5x25)		2 (2x16 + 3x25)	12 652 –12 692 –12 654	10/40

### Module covers

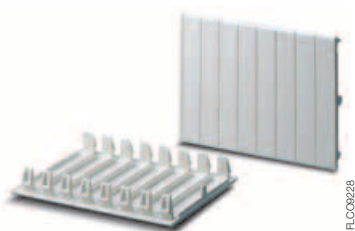

### Wall brackets



Code	Colour	No modules	Box/pack No items
<b>12 861</b>	RAL 7035 grey	1	50/1500
<b>12 863</b>	RAL 7035 grey	4	25/300

Code	Description	For consumer units with	Box/pack No items
<b>12 858</b>	in insulating material	8,10 modules	20/240

### Lock with key



### Spare transparent smoky door

Spring closing



Code	Description	Box/pack No items
<b>12 865</b>	coded type	10/300

Code	For consumer units type	Box/pack No items
<b>12 696</b>	12 644 – 12 684	10/40
<b>12 697</b>	12 646 – 12 686	10/40
<b>12 698</b>	12 650 – 12 690	10/20
	12 652 – 12 692 – 12 654	



Residential/tertiary/industrial application



F.CC98505



# IP 65 wall-mounting consumer units

## IP 65 Fly Series

### Technical characteristics

- protection degree IP 65
- insulation class II
- consumer units fitted with **transparent, smoky horizontally hinged doors** for each row of devices, designed to be fitted with coded lock and key, code 12 866
- available in **RAL 7035 grey**
- in **thermoplastic** material, self-extinguishing and resistant to abnormal heat and fire up to 650 °C (glow wire flammability index) in compliance with IEC 60695-2-11 Standard
- installation temperature from -25 °C to +60 °C
- resistant to heat: ball thermopressure up to +85 °C in compliance with EN 60695-10-2 Standard
- shock resistance 6 Joules (**IK level 08**)
- **extractable DIN rail frame** to facilitate bench cabling. It can also be **dismantled** (and snapped on to reassemble it) to make it easier to cable the individual wires
- possibility of installing devices with depths of 53, 68 and 75 mm
- models with 8 modules and more fitted with one rigid and one bi-material flange for facilitated input of conduits and cables
- models with 8 modules and more designed to be used with rapid UNIFIX L cabling system
- consumer units made and produced in compliance with CEI 23-49 (1996) + V1 + V2, CB certificate IEC 60670-24 Standards
- consumer units are supplied complete with:
  - module covers
  - 4 screw cover caps for guarantee
  - 1 self-adhesive indicator strip per row
  - 1 plate for CEI 23-51 certification
  - instruction sheet

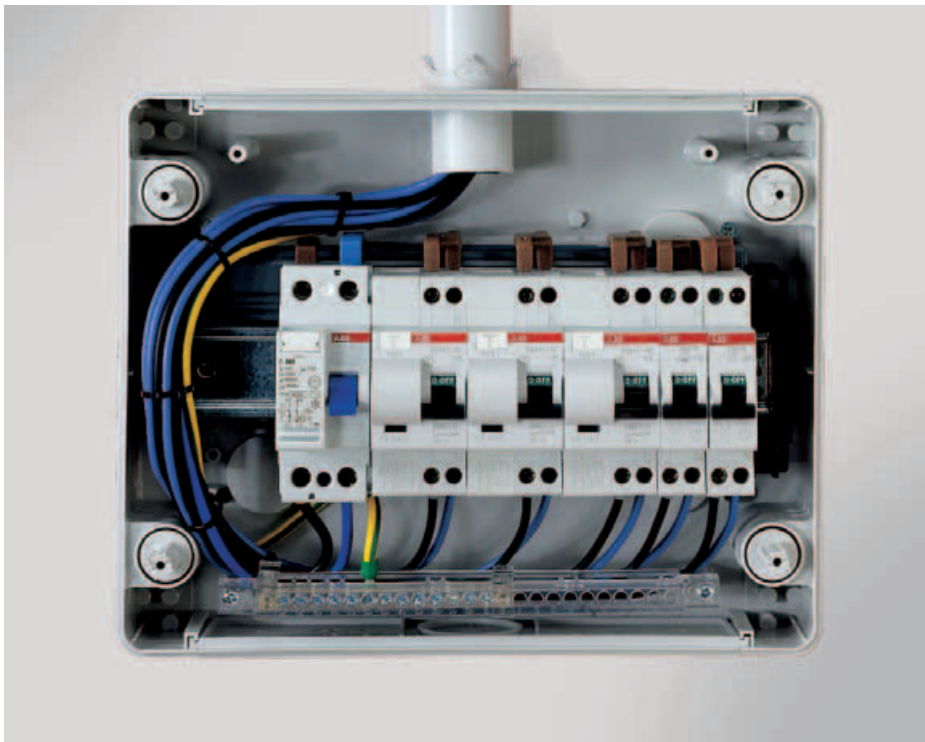

# IP 65 wall-mounting consumer units

## IP 65 Fly Series

2-4 modules

8 modules

12 modules

With transparent, horizontally hinged door

RAL 7035 grey

2



FLCO9072

Code	Dimensions (mm) WxHxD	Box/pack No items
<b>12 742</b>	105x175x111	1/33
<b>12 722<sup>1)</sup></b>	105x175x111	1/33



FLCO9073

Code	Dimensions (mm) WxHxD	Box/pack No items
<b>12 743</b>	205x220x140	1/8



FLCO9074

Code	Dimensions (mm) WxHxD	Box/pack No items
<b>12 745</b>	275x220x140	1/6

<sup>1)</sup> Version with opaque door.

# IP 65 wall-mounting consumer units

## IP 65 Fly Series

24 modules

36 modules

With transparent, horizontally hinged door

RAL 7035 grey



Code	Dimensions (mm) WxHxD	Box/pack No items
<b>12 746</b>	275x370x140	1/4



Code	Dimensions (mm) WxHxD	Box/pack No items
<b>12 747</b>	275x570x140	1/2

# IP 65 wall-mounting consumer units

## Accessories for IP 65 Fly Series

### Terminal blocks

The complete terminal blocks are composed of a combination of terminal holders and terminal bars as indicated in the description, with the terminal bars already mounted on terminal holders.

Configuration of the complete terminal block is standard. For different requirements (customized terminal block), the terminal holders and bars must be procured separately in the versions indicated in the table.

2

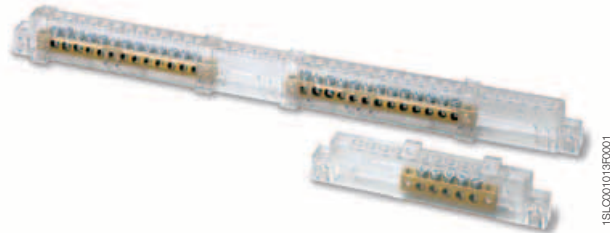

Code	Description	Box/pack No items
<b>12 491</b>	for 8 modules – composed of 12539x2 + 12531x2	10/60
<b>12 492</b>	for 12 modules – composed of 12540x1 + 12531x1 + 12532x1	10/40
<b>12 494</b>	for 24 modules – composed of 12540x2 + 12533x2	10/40
<b>12 493</b>	for 36 modules (3 rows) – composed of 12540x2 + 12534x2	10/40

### Terminal holders



### Terminal bars

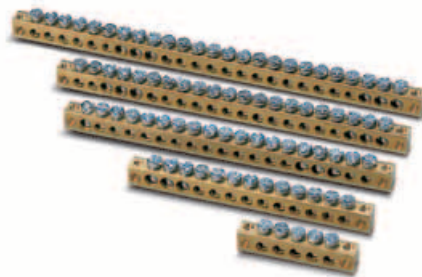

Code	Description	For consumer units type	Box/pack No items
<b>12 539</b>	for 8 modules	12 743	12/144
<b>12 540</b>	for 12 modules per row	12 745 – 12 746 – 12 747	12/144

The terminal block is completed by combining the necessary terminal bars to the terminal holders, taking care to keep the terminal bars separated from each other.

Code	Description	Box/pack No items
No of holes x Ø holes (mm) + No of holes x mm <sup>2</sup>		
<b>12 531</b>	5x16	20/240
<b>12 532</b>	10x16 + 3x25	20/240
<b>12 533</b>	16x16 + 3x25	20/240
<b>12 534</b>	15x16 + 6x25	20/240
<b>12 535</b>	19x16 + 6x25	20/240

The terminal bars can be installed on any kind of terminal holder; they are snapped onto these with 2 clips per bar, through two holes made at the ends of the bar itself.

Terminal holders and terminal bars are supplied separately. In this way, by inserting one or two terminal bars into the terminal holder you can create the best terminal for your requirements, with the advantage of obtaining a terminal block that is cheap as well as personalised, due to the fact that you only need to use material that is really necessary. Some standard configurations are illustrated in the table.

All the possible configurations that can be created for each type of consumer unit given in the technical details.

# IP 65 wall-mounting consumer units

## Accessories for IP 65 Fly Series

### Module covers

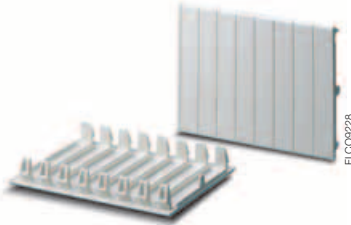

Code	Colour	No modules	Box/pack No items
<b>12 861</b>	RAL 7035 grey	1	50/1500
<b>12 863</b>	RAL 7035 grey	4	25/300

### Plastic wall brackets



Code	Description	Box/pack No items
<b>12 858</b>	in insulating material	20/240

### Screw lead sealing accessories



Code	Box/pack No items
<b>12 860</b>	50/1500

### Spare flanges

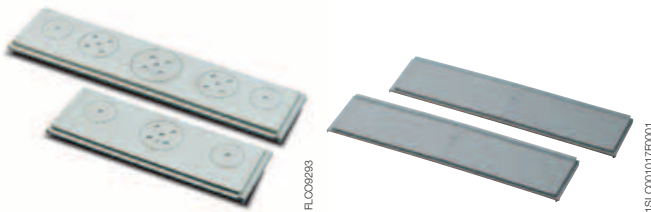

Code	For consumer units type	Box/pack No items
<b>12 600</b>	8 modules, bi-material	30/120
<b>12 601</b>	12, 24, 36 (12x3 rows) modules, bi-material	20/80
<b>1SL0550A00</b>	rigid flange, 8 modules per row	30/120
<b>1SL0551A00</b>	rigid flange, 12 modules per row	20/80

### Spare doors



Code	Description	For consumer units type	Box/pack No items
<b>12 567</b>	opaque RAL 7035 grey for 2 mod.	12 722	10/60
<b>12 577</b>	transparent for 2 mod.	12 742	10/60
<b>12 565</b>	transparent for 8 mod.	12 743	10/60
<b>12 566</b>	transparent for 12, 24, 36 (12x3 rows) mod.	12 745 – 12 746 12 747	8/16

### Semi-flush-mounting frames



Code	For consumer units type	Box/pack No items
<b>12 591</b>	12 743	5/20
<b>12 592</b>	12 745	5/20
<b>12 593</b>	12 746	5/20
<b>12 594</b>	12 747	5/5

### Lock with key



Code	Description	Box/pack No items
<b>12 866</b>	coded type	10/300

Residential/tertiary/industrial application



FLO9804



# IP 65 wall-mounting consumer units

## IP 65 Europa Series

### Technical characteristics

- protection degree IP 65
- insulation class II
- available in two versions: with opaque door and with transparent, smoky vertically hinged door
- available in RAL 7035 grey
- in thermoplastic material, self-extinguishing and resistant to abnormal heat and fire up to 650 °C (glow wire flammability index) in compliance with IEC 60695-2-11 Standard
- installation temperature from -25 °C to +60 °C
- resistant to heat: ball thermopressure up to +85 °C in compliance with EN 60695-10-2 Standard
- shock resistance 6 Joules (IK level 08)
- rated insulation voltage: 1000 V AC; 1500 V DC
- door designed to be fitted with coded lock and key, code 12 866
- extractable DIN rail frame to facilitate bench cabling. It can also be dismantled (and snapped on to reassemble it) to make it easier to cable the individual wires
- possibility of installing devices with depths of 53, 68 and 75 mm
- perfectly symmetrical consumer units with the possibility of attaching the door hinge onto the front (by means of the special articulated screws supplied) on the right or left with 140° opening
- models with 8 modules and more designed to be used with the UNIFIX L cabling system
- models with 8 modules and more fitted with one rigid and one bi-material flange to facilitate input of conduits and cables
- consumer units made and produced in compliance with CEI 23-49 (1996) + V1 + V2, CB certificate IEC 60670-24 Standards
- consumer units are supplied complete with:
  - module covers
  - 4 screw-cover caps to guarantee
  - accessories for attaching the hinges to the front
  - 1 self-adhesive indicator strip per row
  - 1 plate for CEI 23-51 certification
  - instruction sheet

2



1SL0001020F0001

IMQ mark



IP 65 Europa Series wall-mounting consumer units obtained the IMQ mark of approval

# IP 65 wall-mounting consumer units

## IP 65 Europa Series

4 modules

8 modules

12 modules

18 modules

With opaque, vertically hinged door

RAL 7035 grey

2



FLO09089



FLO09090



FLO09091

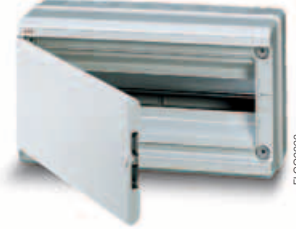

FLO09092

Code	Dimensions (mm) WxHxD	Box/pack No items
<b>12 724</b>	140x220x140	1/14

Code	Dimensions (mm) WxHxD	Box/pack No items
<b>12 728</b>	205x220x140	1/9

Code	Dimensions (mm) WxHxD	Box/pack No items
<b>12 732</b>	275x220x140	1/6

Code	Dimensions (mm) WxHxD	Box/pack No items
<b>12 733</b>	380x220x140	1/5

With transparent, smoky vertically hinged door

RAL 7035 grey



FLO09087

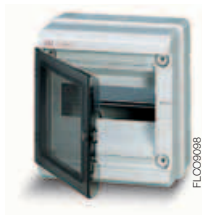

FLO09088

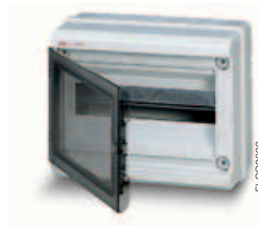

FLO09089



FLO09100

Code	Dimensions (mm) WxHxD	Box/pack No items
<b>12 744</b>	140x220x140	1/14

Code	Dimensions (mm) WxHxD	Box/pack No items
<b>12 748</b>	205x220x140	1/9

Code	Dimensions (mm) WxHxD	Box/pack No items
<b>12 752</b>	275x220x140	1/6

Code	Dimensions (mm) WxHxD	Box/pack No items
<b>12 753</b>	380x220x140	1/5

# IP 65 wall-mounting consumer units

## IP 65 Europa Series

24 modules

36 modules

36 modules

54 modules

With opaque, vertically hinged door

RAL 7035 grey



FLC09033



FLC09034



FLC09035



FLC09036

Code	Dimensions (mm) WxHxD	Box/pack No items
<b>12 734</b>	275x370x140	1/4

Code	Dimensions (mm) WxHxD	Box/pack No items
<b>12 735</b>	380x370x140	1/2

Code	Dimensions (mm) WxHxD	Box/pack No items
<b>12 736</b>	275x570x140	1/2

Code	Dimensions (mm) WxHxD	Box/pack No items
<b>12 738</b>	380x570x140	1/2

With transparent, smoky vertically hinged door

RAL 7035 grey



FLC09101



FLC09102



FLC09103



FLC09104

Code	Dimensions (mm) WxHxD	Box/pack No items
<b>12 754</b>	275x370x140	1/4

Code	Dimensions (mm) WxHxD	Box/pack No items
<b>12 755</b>	380x370x140	1/2

Code	Dimensions (mm) WxHxD	Box/pack No items
<b>12 756</b>	275x570x140	1/2

Code	Dimensions (mm) WxHxD	Box/pack No items
<b>12 758</b>	380x570x140	1/2

# IP 65 wall-mounting consumer units

## Accessories for Europa Series

### Terminal blocks

The complete terminal blocks are composed of a combination of terminal holders and terminal bars as indicated in the description, with the terminal bars already mounted on terminal holders.

Configuration of the complete terminal block is standard. For different requirements (customized terminal block), the terminal holders and bars must be procured separately in the versions indicated in the table.



Code	Description	Box/pack No items
<b>12 490</b>	for 4 modules – composed of 12538x2 + 12531x2	10/60
<b>12 491</b>	for 8 modules – composed of 12539x2 + 12531x2	10/60
<b>12 492</b>	for 12 modules – composed of 12540x1 + 12531x1 + 12532x1	10/40
<b>12 498</b>	for 18 modules – composed of 12543x1 + 12531x1 + 12535x1	10/40
<b>12 494</b>	for 24 modules – composed of 12540x2 + 12533x2	10/40
<b>12 493</b>	for 36 modules (3 rows) – composed of 12540x2 + 12534x2	10/40
<b>12 507</b>	for 36 modules (2 rows) – composed of 12543x2 + 12534x2	10/40
<b>12 497</b>	for 54 modules – composed of 12543x2 + 12535x2	10/40

### Terminal holders



### Terminal bars

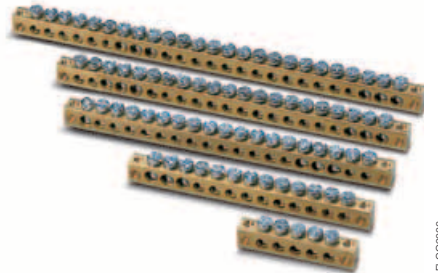

Code	Description	For consumer units type	Box/pack No items
<b>12 538</b>	for 4 modules	12 724 –12 744	12/360
<b>12 539</b>	for 8 modules	12 728 –12 748	12/360
<b>12 540</b>	for 12 modules per row	12 732 –12 752	12/144
		12 734 –12 754	
		12 736 –12 756	
<b>12 543</b>	for 18 modules per row	12 733 –12 753	12/108
		12 735 –12 755	
		12 738 –12 758	

Code	Description No of holes x Ø holes (mm) + No of holes x mm <sup>2</sup>	Box/pack No items
<b>12 531</b>	5x16	20/240
<b>12 532</b>	10x16 + 3x25	20/240
<b>12 533</b>	16x16 + 3x25	20/240
<b>12 534</b>	15x16 + 6x25	20/240
<b>12 535</b>	19x16 + 6x25	20/240

The terminal bars can be installed on any kind of terminal holder; they are snapped onto these with 2 clips per bar, through two holes made at the ends of the bar itself.

The terminal block is completed by combining the necessary terminal bars to the terminal holders, taking care to keep the terminal bars separate from each other.

Terminal holders and terminal bars are supplied separately. In this way, by inserting one or two terminal bars into the terminal holder you can create the best terminal for your requirements, with the advantage of obtaining a terminal block that is cheap as well as personalised, due to the fact that you only need to use material that is really necessary. Some standard configurations are illustrated in the table.

All the possible configurations that can be created for each type of consumer unit are given in the technical details.

# IP 65 wall-mounting consumer units

## Accessories for Europa Series

### Module covers



Code	Colour	No modules	Box/pack No items
<b>12 861</b>	RAL 7035 grey	1	50/1500
<b>12 863</b>	RAL 7035 grey	4	25/300

### Spare flanges

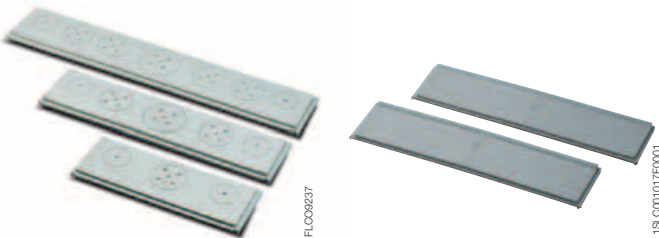

Code	For consumer units type	Box/pack No items
<b>12 600</b>	8 modules, bi-material	30/120
<b>12 601</b>	12, 24, 36 (12x3 rows) modules, bi-material	20/80
<b>12 602</b>	18, 36 (18x2 rows), 54 modules, bi-material	20/80
<b>1SL0550A00</b>	rigid flange, 8 modules per row	30/120
<b>1SL0551A00</b>	rigid flange, 12 modules per row	20/80
<b>1SL0552A00</b>	rigid flange, 18 modules per row	20/80

### Lock with key



Code	Description	Box/pack No items
<b>12 866</b>	coded type	10/300

### Plastic wall brackets



Code	Description	Box/pack No items
<b>12 858</b>	in insulating material	20/240

### Semi-flush-mounting frames



Code	For consumer units type	Box/pack No items
<b>12 590</b>	12 724 –12 744	5/20
<b>12 591</b>	12 728 –12 748	5/20
<b>12 592</b>	12 732 –12 752	5/20
<b>12 593</b>	12 734 –12 754	5/20
<b>12 594</b>	12 736 –12 756	5/5
<b>12 595</b>	12 738 –12 758	5/5
<b>12 596</b>	12 733 –12 753	5/5
<b>12 597</b>	12 735 –12 755	5/5

### Spare doors



Opaque RAL 7035 grey	Transparent smoky	For consumer units type	Box/pack No items
<b>12 568</b>	<b>12 578</b>	12 724 –12 744	1/8
<b>12 569</b>	<b>12 579</b>	12 728 –12 748	1/10
<b>12 570</b>	<b>12 580</b>	12 732 –12 752	1/8
<b>12 571</b>	<b>12 581</b>	12 734 –12 754	1/5
<b>12 572</b>	<b>12 582</b>	12 736 –12 756	1/10
<b>12 573</b>	<b>12 583</b>	12 738 –12 758	1/8
<b>12 584</b>	<b>12 586</b>	12 733 –12 753	1/20
<b>12 585</b>	<b>12 587</b>	12 735 –12 755	1/8



Tertiary/Industrial application



FLC0814



FLC0813





# Panel fronts

## IP 40 and IP 55 panel fronts

### IP 40 panel fronts

#### Technical characteristics

- protection degree IP 40
- in **thermoplastic**, self-extinguishing and resistant to abnormal heat and fire up to 650 °C (glow wire flammability index) in compliance with IEC 60695-2-11 Standard
- available in **RAL 7035 grey**
- installation temperature from -25 °C to +60 °C
- resistant to heat: ball thermopressure up to +85 °C in compliance with EN 60695-10-2 Standard
- fronts are supplied with:
  - module covers
  - instruction sheet

### IP 55 panel fronts

#### Technical characteristics

- protection degree IP 55
- available with transparent, smoky horizontally hinged door in the version with lock and lead-sealable spring
- door designed to take a lock with coded key code 12 865
- available in **RAL 7035 grey**
- in **thermoplastic**, self-extinguishing and resistant to abnormal heat and fire up to 650 °C (glow wire flammability index) in compliance with IEC 60695-2-11 Standard
- installation temperature from -25 °C to +60 °C
- resistant to heat: ball thermopressure up to +85 °C in compliance with EN 60695-10-2 Standard
- shock resistance 6 Joules
- fronts are supplied with:
  - module covers
  - instruction sheet



FLC0856

# IP 40 and IP 55 panel fronts

## IP 40 and IP 55 panel fronts

### 2 modules

### 3 modules

### 4 modules

#### IP 40 panel fronts

RAL 7035 grey



Code	Dimensions (mm) WxHxD	Box/pack No items
<b>12 362</b>	81x90x50	10/40

Code	Dimensions (mm) WxHxD	Box/pack No items
<b>12 363</b>	99x90x50	10/40

Code	Dimensions (mm) WxHxD	Box/pack No items
<b>12 364</b>	117x90x50	6/24

### 4 modules

### 6 modules

### 10 modules

#### IP 55 panel fronts

RAL 7035 grey

Spring closing



Code	Dimensions (mm) WxHxD	Box/pack No items
<b>12 658</b>	125x180x80	1/10

Code	Dimensions (mm) WxHxD	Box/pack No items
<b>12 659</b>	160x180x80	1/10

Code	Dimensions (mm) WxHxD	Box/pack No items
<b>12 660</b>	230x180x80	1/7

# IP 40 and IP 55 panel fronts

## Accessories for IP 55 panel fronts

### Module covers

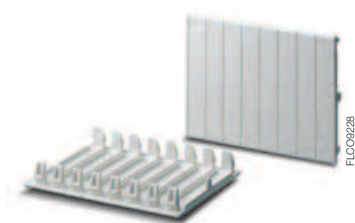

Code	Colour	No modules	Box/pack No items
<b>12 861</b>	RAL 7035 grey	1	50/1500
<b>12 863</b>	RAL 7035 grey	4	25/300

### Lock with key



Code	Description	Box/pack No items
<b>12 865</b>	coded type	10/300

### Spare transparent smoky doors

Spring closing



Code	For fronts type	Box/pack No items
<b>12 696</b>	12 658	10/40
<b>12 697</b>	12 659	10/40
<b>12 698</b>	12 660	10/20





## Index

### Livorno Series flush- and wall- mounting consumer units

Flush-mounting consumer units.....	3/3
Wall-mounting consumer units.....	3/3
Flush- and wall- mounting consumer units with emergency button.....	3/3
Accessories.....	3/6

Tertiary/Industrial application



FCC0816



# Emergency consumer units

## Livorno Series flush- and wall- mounting consumer units

### Livorno Series flush- and wall- mounting consumer units Technical characteristics

- protection degree IP40, IP55 or IP65 depending on the version
- available in the colours RAL 3000 red and RAL 7035 grey
- installation temperature from -25 °C to +60 °C
- resistant to heat: ball thermopressure up to +85 °C in compliance with EN 60695-10-2 Standard
- door front with **breakable glass 0.75 Joules (IK level 05)**
- in thermoplastic material, self-extinguishing and resistant to abnormal heat and fire up to 650 °C (glow wire flammability index) in compliance with IEC 60695-2-11 Standard
- consumer units fitted with lock and coded key
- consumer units are supplied complete with:
  - module covers (versions with DIN rail)
  - 4 screw-cover caps
  - 1 certification plate

### Livorno Series consumer units with emergency button Technical characteristics

- protection degree IP55
- flush and wall-mounting versions
- available in colour RAL 3000 red
- installation temperature from -25 °C to +60 °C
- door front with breakable glass 0.75 Joules (IK level 05)
- in thermoplastic material, self-extinguishing and resistant to abnormal heat and fire up to 650 °C (glow wire flammability index) in compliance with IEC 60695-2-11 Standard
- with luminous button, with 1 NO contact + 1 NC contact (2 A, 250 V)
- they can be fitted with E10: 12 V incandescence, 24 V incandescence or 250 V fluorescence
- complete with glass-breaking hammer
  - in compliance with EN 60670-1 (2005) Standard
  - operational rated voltage: Ue 250 V
  - utilization category AC 12
  - operational rated current Ie 2 A
  - rated insulation voltage Ui 250 V
  - pollution degree: 3
  - utilization type and data of fuses Legrand 10 A, type gG, 10.3 x 38 mm

3



IMQ mark



Livorno Series emergency consumer units with luminous button obtained the IMQ mark of approval

# Emergency consumer units

## Livorno Series flush- and wall- mounting consumer units

100x100x50 mm

200x245x82 mm

200x245x82 mm

### Flush-mounting version

IP 55

RAL 3000 red

Possibility of installing on flush-mounting enclosure with inter-axis of 83.5 mm. With luminous button (E10 -12/24 V incandescence and 250 V fluorescence), with 1 NO contact + 1 NC contact (2 A, 250 V) complete with glass-breaking hammer.



Code	Box/pack No items
<b>13 183</b>	1/13

IP 40

RAL 3000 red



Code	Description	Box/pack No items
<b>13 144</b>	with DIN rail x 6 mod.	1/7
<b>13 154</b>	with panel	1/7

IP 40

RAL 7035 grey



Code	Description	Box/pack No items
<b>13 143</b>	with DIN rail x 6 mod.	1/7
<b>13 153</b>	With panel	1/7

100x100x50 mm

205x220x140 mm

205x220x140 mm

165x180x110 mm

### Wall-mounting version

IP 55

RAL 3000 red

With luminous button (E10-12/24 V incandescence and 250 V fluorescence), with 1 NO contact + 1 NC contact (2 A, 250 V) complete with glass-breaking hammer.



Code	Box/pack No items
<b>13 180</b>	1/14

IP 65

RAL 3000 red

Fitted with flanges for facilitated branch connections.



Code	Description	Box/pack No items
<b>13 171</b>	with DIN rail x 8 mod.	1/6
<b>13 175</b>	with panel	1/6

IP 65

RAL 7035 grey

Fitted with flanges for facilitated branch connections.



Code	Description	Box/pack No items
<b>13 170</b>	with DIN rail x 8 mod.	1/6
<b>13 174</b>	with panel	1/6

IP 55

RAL 3000 red



Code	Description	Box/pack No items
<b>13 161</b>	with DIN rail x 8 mod.	1/12
<b>13 165</b>	with panel	1/12

# Emergency consumer units

Livorno Series flush- and wall- mounting consumer units

165x180x110 mm

170x210x110 mm

170x210x110 mm

## Wall-mounting version

IP 55  
RAL 3075 grey

IP 40  
RAL 3000 red

IP 40  
RAL 3075 grey



FLC09281



FLC09120



FLC09283

Code	Description	Box/pack No items
<b>13 160</b>	with DIN rail x 8 mod.	1/12
<b>13 164</b>	With panel	1/12

Code	Description	Box/pack No items
<b>13 141</b>	with DIN rail x 8 mod.	1/6
<b>13 151</b>	with panel	1/6

Code	Description	Box/pack No items
<b>13 140</b>	with DIN rail x 8 mod.	1/6
<b>13 150</b>	with panel	1/6

# Emergency consumer units

## Accessories

### Spare lid



### Lamps for emergency button



3

Code	Description	Box/pack No items
<b>13 190</b>	for consumer units fitted with emergency button	10/40

Code	Description	Box/pack No items
<b>13 187</b>	12 V – incandescence	10/120
<b>13 188</b>	24 V – incandescence	10/120
<b>13 189</b>	250 V – fluorescence	10/120

### Glass-breaking hammer



### Wall brackets



Code	Description	Box/pack No items
<b>13 186</b>	glass-breaking hammer	10/300

Code	Description	Box/pack No items
<b>12 858</b>	only for IP 65 consumer units in insulating material	20/240



## Index

Introduction .....	4/2
Unifix L .....	4/4
Unifix L system components.....	4/6

# Unifix cabling system

## Introduction

### Unifix cabling system: the ideal complement for the ABB consumer units

Unifix is the ABB cabling system which makes the work of installers and switchboard builders easier: with its standard connectors, Unifix effects simple, quick and safe wiring of System pro *M* modular devices in ABB consumer units.

For this reason, it is the ideal solution for exploiting the fact that ABB products for low voltage applications can be perfectly integrated whilst at the same time guaranteeing safety and full compliance with Standards.

The system consists of two **series H** and **L**. Each one is suitable for specific applications both for the installation of devices and installation in switchboards. In detail:

- the **H series**, intended for more demanding applications, is used for wiring SACE Isomax S1 and S2 and Tmax T1...T3 moulded-case circuit-breakers and System pro *M* modular devices in ArTu® switchboards (rated currents up to 400 A and short-circuit currents up to 50 kA);

- the **L series** is the universal solution for wiring System pro *M* modular devices in ArTu® switchboards and polycarbonate consumer units (rated currents up to 100 A and short-circuit currents up to 25 kA).

### Special features

The main feature of Unifix lies with the possibility of combining different types of circuits (one-phase/three-phase/auxiliary) in a single module. Pre-wiring can be effected at the workbench and installed in the switchboard subsequently, with no limits to the type or combination of devices which can be installed.

Unifix has adjustable pitch which replaces traditional wiring harnesses which means that circuit-breakers with different polarities can be placed in the same row as well as auxiliary modular devices.

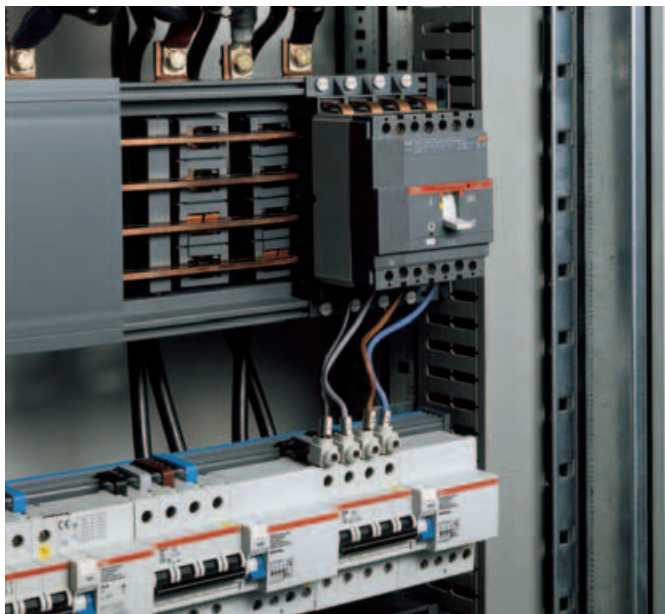

WEUN8017



WEUN8018

The Unifix cabling system can be used with ABB SACE devices only.



# Unifix cabling system

## Introduction

### ONE SYSTEM, MANY ADVANTAGES



Considerable **reduction in wiring times**: by using rigid lock connectors which are standardized for the different types of device, each device does not have to be connected using cables.



**Greater standardization of low voltage switchboards and consumer units**: the rigid connectors enable the **results of the type tests** (overheating and short-circuit) effected by ABB **to be extended** also on input wiring of devices.



A more **advanced** and, at the same time, **cheaper technical solution** compared with traditional wiring. This is made possible by cutting down on materials (wires and wire terminals) and space required, thus affecting operating times.



**Can be used on all ABB** standard devices, without modifying or adding accessories and without using special equipment.



**Adjustable pitch**: Unifix uses adjustable pitch unlike traditional wiring harnesses; in this way, circuit-breakers with different polarity can be placed in the same row as well as auxiliary devices.

# Unifix cabling system

## Unifix L

### Unifix L: the universal solution for switchboards and consumer units

With its special features, the Unifix L version is extremely versatile in its use and meets the demands of installations which vary a great deal with regard to function and size. Unifix L is suitable for wiring System pro *M* modular devices in ArTu® switchboards and ABB polycarbonate consumer units, for rated currents up to 100 A and short-circuit currents up to 25 kA. The devices are supplied top-down by way of special standard rigid connectors.

#### TECHNICAL CHARACTERISTICS

##### Busbars

The busbars consist of a support which contains a system of 100 A capacity conductors (central supply) and 25 kA short-circuit current (conditioned). They are available in two-pole and four-pole versions for widths of 12, 18, 24 or 36 modules which can be installed in the ArTu switchboards with widths of 400, 600 and 800 mm respectively (18 modules excluded).

Fixing is carried out by dove-tailing on the rear of the DIN rail and installation is in two modules with H=200 mm.

The busbar system is structured in such a way that it is possible to attach special supports for ducts with max. dimensions 60x80 mm on the rear.

##### Power supply module with cable

The 63 A power supply module can be inserted directly in the busbar conductors in the two-pole and four-pole versions. Its dimensions are equivalent to two base modules (17.5 mm) and direct supply the busbars when there is no main circuit-breaker in the row.

The four-pole version, with a cross-section of 16 mm<sup>2</sup>, is supplied with the following cable lengths:

- 400 mm;
- 600 mm;
- 800 mm;
- 1500 mm;
- 2500 mm.



WEUN8037

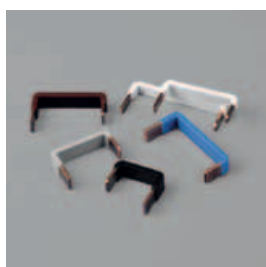

WEUN8039



WEUN8038



WEUN8040

##### Power supply module without cable

The one-pole 100 A supplier module in the L1, L2, L3, N versions is directly inserted in the busbar conductors. Its dimensions are equivalent to a base module (17.5 mm) and it directly supplies the busbars when there is no main circuit-breaker in the row. It is equipped with a terminal which enables connection of a conductor with a cross-section of 35 mm<sup>2</sup>.

##### Connections for devices

The connections consist of insulated copper busbars, cut and bent to size. They supply each terminal of the System pro *M* modular devices and the busbar system. The connections are supplied according to the polarity of the device which must be wired (connectors are available for L1, L2, L3, N and in the version for 1P + N devices in a DIN module). Supports with a cable are also available for supplying auxiliary devices so that devices on the same row can be wired to the modular circuit-breakers.

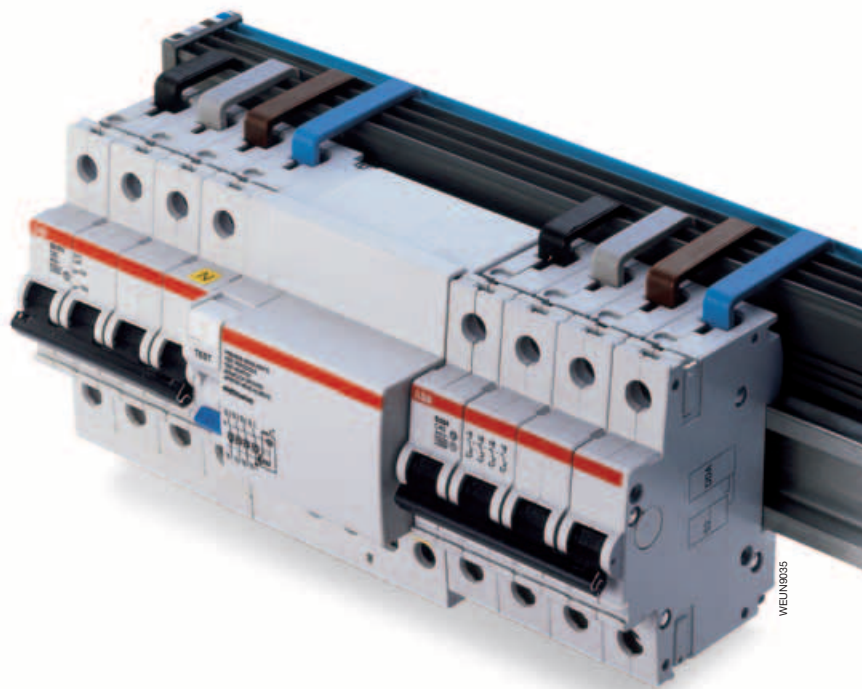

WEUN8035

# Unifix cabling system

## Unifix L system components

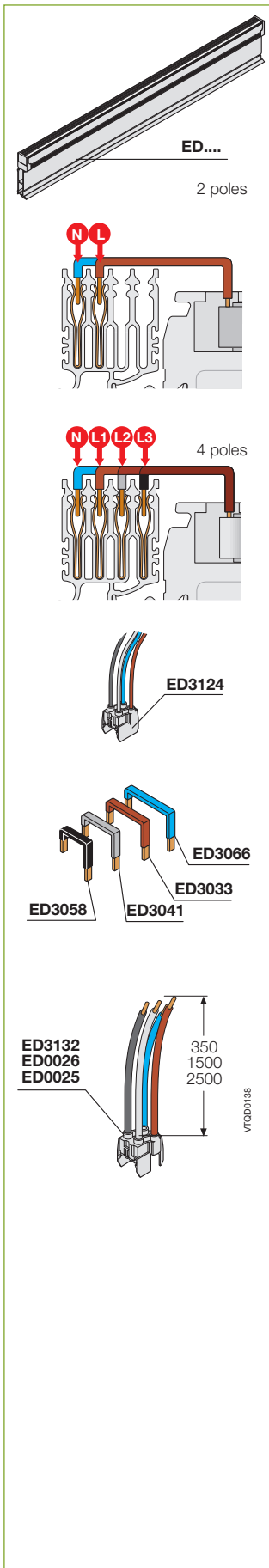

Code	Description	Pck./Pieces
------	-------------	-------------

### 2-pole busbars

ED2985	Busbars 100A 2P 8 modules	1/6
ED2993	Busbars 100A 2P 12 modules (W=400 mm)	1/6
ED3009	Busbars 100A 2P 18 modules	1/6
ED3017	Busbars 100A 2P 24 modules (W=600 mm)	1/6
ED3025	Busbars 100A 2P 36 modules (W=800 mm)	1/6

### 4-pole busbars

ED2944	Busbars 100A 4P 12 modules (W=400 mm)	1/6
ED2951	Busbars 100A 4P 18 modules	1/6
ED2969	Busbars 100A 4P 24 modules (W=600 mm)	1/6
ED2977	Busbars 100A 4P 36 modules (W=800 mm)	1/6

### Connections for different devices

ED3108	Connection with 2 cables L/N 16A	1/6
ED3116	Connection with 3 cables L1/L2/L3 16A	1/6
ED3124	Connection with 4 cables L1/L2/L3/N 16A	1/6
ED3355	Connection with 2 cables L1/N 40A	1/6
ED3363	Connection with 3 cables L1/L2/L3 40A	1/6
ED3371	Connection with 4 cables L1/L2/L3/N 40A	1/6

### Connection for devices

ED3272	10 connection L1-N 40 A	1/10
ED3280	10 connection L2-N 40 A	1/10
ED3298	10 connection L3-N 40 A	1/10
ED3033	10 connection L 1 100A	1/10
ED3041	10 connection L 2 100A	1/10
ED3058	10 connection L 3 100A	1/10
ED3066	10 connection N 100A	1/10
ED3132	Power supplies with cable 4P 100A (W=350 mm)	1/6
ED0026	Power supplies with cable 4P 100A (W=1500 mm)	1/6
ED0025	Power supplies with cable 4P 100A (W=2500 mm)	1/6

# Unifix cabling system

## Unifix L system components



Code	Description	Pck./Pieces
------	-------------	-------------

### Power supply modules with cable

<b>ED3082</b>	Supply modules 2P 100A with cable W=600mm	1/6
<b>ED3405</b>	Supply modules 4P 100A with cable W=400mm	1/6
<b>ED3090</b>	Supply modules 4P 100A with cable W=600mm	1/6
<b>ED3413</b>	Supply modules 4P 100A with cable W=800mm	1/6
<b>ED3439</b>	Supply modules 4P 100A with cable W=1500mm	1/6

### Power supply modules without cable in 100A

<b>ED3101</b>	10 one-pole supply modules L 1	1/10
<b>ED3102</b>	10 one-pole supply modules L 2	1/10
<b>ED3103</b>	10 one-pole supply modules L 3	1/10
<b>ED3104</b>	10 one-pole supply modules N	1/10

## Index

### Switchboards for industrial applications

Europa Series switchboards for industrial applications .....	5/3
Switchboards for industrial applications with blank front .....	5/11



Tertiary/Industrial application





FLC08810



# Switchboards

## Europa Series switchboards for industrial applications

### Technical characteristics

- protection degree **IP 65**
- insulation class II 
- available in the versions with opaque and transparent, smoky vertically hinged doors
- available in **RAL 7035 grey**
- in **polycarbonate** material, self-extinguishing and resistant to abnormal heat and fire up to 960 °C (glow wire flammability index) in compliance with IEC 60695-2-11 Standard
- installation temperature from -25 °C to +60 °C
- resistant to heat: ball thermopressure up to +125 °C in compliance with EN 60695-10-2 Standard
- shock resistance 20 Joules (**IK level 10**)
- perfectly symmetrical switchboards with the possibility of attaching the door hinge onto the front (by means of the special articulated screws supplied) on the right or left with 140° opening
- doors designed to take lock with coded key, code 12 866
- designed for the insertion of an extractable frame with pre-drilled panelling for mounting 100, 125 and 160 A circuit breakers
- all models (except for code 12 764 and 12 784) are fitted with one rigid and one bi-material flange to facilitate insertion of conduits and cables
- switchboards made and produced in compliance with CEI 23-49 (1996) + V1 + V2, CB certificate IEC 60670-24 Standards
- switchboards are supplied complete with:
  - 4 screw-cover caps to guarantee 
  - accessories for hinging the front part
  - 1 certification plate
  - instruction sheet
- use 3.5x9.5 self-tapping screws to fix the components on the back



IMQ mark 

Europa Series switchboards for industrial applications obtained the IMQ mark of approval

# Switchboards

## Europa Series switchboards for industrial applications

140x220x140 mm

205x220x140 mm

275x220x140 mm

### Opaque, vertically hinged door

RAL 7035 grey



FLC09146



FLC09145



FLC09143

Code	Dimensions (mm) WxHxD	Box/pack No items
<b>12 764</b>	140x220x140	1/14

Code	Dimensions (mm) WxHxD	Box/pack No items
<b>12 768</b>	205x220x140	1/9

Code	Dimensions (mm) WxHxD	Box/pack No items
<b>12 772</b>	275x220x140	1/6

### Transparent, smoky vertically hinged door

RAL 7035 grey



FLC09138



FLC09136



FLC09137

Code	Dimensions (mm) WxHxD	Box/pack No items
<b>12 784</b>	140x220x140	1/14

Code	Dimensions (mm) WxHxD	Box/pack No items
<b>12 788</b>	205x220x140	1/9

Code	Dimensions (mm) WxHxD	Box/pack No items
<b>12 792</b>	275x220x140	1/6

# Switchboards

## Europa Series switchboards for industrial applications

275x370x140 mm

275x570x140 mm

380x570x140 mm

### Opaque, vertically hinged door

RAL 7035 grey



FLCO9144



FLCO9141



FLCO9142

Code	Dimensions (mm) WxHxD	Box/pack No items
<b>12 774</b>	275x370x140	1/4

Code	Dimensions (mm) WxHxD	Box/pack No items
<b>12 776</b>	275x570x140	1/2

Code	Dimensions (mm) WxHxD	Box/pack No items
<b>12 778</b>	380x570x140	1/2

5

### Transparent, smoky vertically hinged door

RAL 7035 grey



FLCO9139



FLCO9140



FLCO9135

Code	Dimensions (mm) WxHxD	Box/pack No items
<b>12 794</b>	275x370x140	1/4

Code	Dimensions (mm) WxHxD	Box/pack No items
<b>12 796</b>	275x570x140	1/2

Code	Dimensions (mm) WxHxD	Box/pack No items
<b>12 798</b>	380x570x140	1/2

# Switchboards

## Accessories for Europa Series switchboards for industrial applications

### Kit for modular circuit breakers

Circuit breakers 100, 125 160 A on DIN rail



Code	For switchboards type	No modules	Box/pack No items
<b>12 820</b>	12 774 – 12 794	12 for 1 rows	1/8
<b>12 821</b>	12 776 – 12 796	24 for 2 rows	1/5
<b>12 822</b>	12 778 – 12 798	36 for 2 rows	1/5

### DIN section bars

Completed with screws



Code	For switchboards type	Box/pack No items
<b>12 852</b>	12 764 – 12 784	50/600
<b>12 854</b>	12 768 – 12 788	30/360
<b>12 855</b>	12 772 – 12 792	50/200
	12 774 – 12 794	
	12 776 – 12 796	
<b>12 856</b>	12 778 – 12 798	50/200

5

### Base plates

In aluminium-plated metal



Code	For switchboards type	Box/pack No items
<b>12 842</b>	12 764 – 12 784	10/120
<b>12 844</b>	12 768 – 12 788	10/10
<b>12 845</b>	12 772 – 12 792	10/10
<b>12 846</b>	12 774 – 12 794	5/5
<b>12 847</b>	12 776 – 12 796	5/5
<b>12 848</b>	12 778 – 12 798	5/5

### Base plates

In insulating material



Code	For switchboards type	Box/pack No items
<b>12 832</b>	12 764 – 12 784	10/10
<b>12 834</b>	12 768 – 12 788	10/10
<b>12 835</b>	12 772 – 12 792	10/10
<b>12 836</b>	12 774 – 12 794	5/5
<b>12 837</b>	12 776 – 12 796	5/5
<b>12 838</b>	12 778 – 12 798	5/5

### Inner doors



Code	For switchboards type	Box/pack No items
<b>12 825</b>	12 774 – 12 794	1/10
<b>12 826</b>	12 776 – 12 796	1/10
<b>12 827</b>	12 778 – 12 798	1/10

# Switchboards

## Accessories for Europa Series switchboards for industrial applications

### Module covers



FLC0928

Code	Colour	No modules	Box/pack No items
<b>12 861</b>	RAL 7035 grey	1	50/1500
<b>12 863</b>	RAL 7035 grey	4	25/300

### Wall brackets



FLC0925

Code	Description	Box/pack No items
<b>12 858</b>	in insulating material	20/240

### Key lock



FLC09240

Code	Description	Box/pack No items
<b>12 866</b>	coded type	10/300

### Universal cutter

For drill

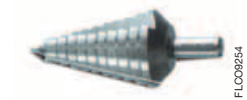

FLC09254

Code	Box/pack No items
<b>12 894</b>	1/30

To use for side branch connections.

# Switchboards

## Accessories for Europa Series switchboards for industrial applications

### Spare doors



Opaque RAL 7035 grey	Transparent smoky	For switchboards type	Box/pack
<b>12 568</b>	<b>12 578</b>	12 764 – 12 784	8/32
<b>12 569</b>	<b>12 579</b>	12 768 – 12 788	10/20
<b>12 570</b>	<b>12 580</b>	12 772 – 12 792	8/16
<b>12 571</b>	<b>12 581</b>	12 774 – 12 794	5/10
<b>12 572</b>	<b>12 582</b>	12 776 – 12 796	10/10
<b>12 573</b>	<b>12 583</b>	12 778 – 12 798	8/8

### Semi-flush-mounting frames



Code	For switchboards type	Box/pack
<b>12 590</b>	12 764 – 12 784	5/20
<b>12 591</b>	12 768 – 12 788	5/20
<b>12 592</b>	12 772 – 12 792	5/20
<b>12 593</b>	12 774 – 12 794	5/20
<b>12 594</b>	12 776 – 12 796	5/5
<b>12 595</b>	12 778 – 12 798	5/5

### Plastic spacer

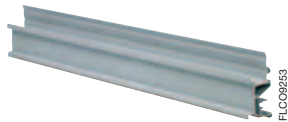

Code	Dimensions (mm)	Box/pack
<b>12 851</b>	20 modules H30	10/60

### Spare flanges

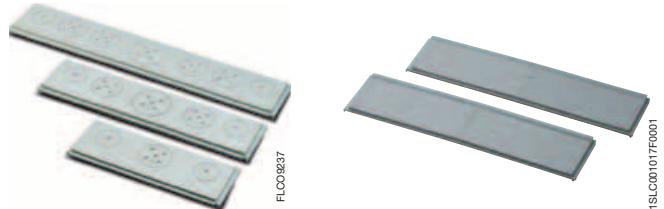

Code	For switchboards type	Box/pack No items
<b>12 600</b>	12 768 – 12 788, bi-material	30/120
<b>12 601</b>	12 772 – 12 792, bi-material	20/80
	12 774 – 12 794, bi-material	
	12 776 – 12 796, bi-material	
<b>12 602</b>	12 778 – 12 798, bi-material	20/80
<b>1SL0550A00</b>	rigid flange 8 modules per row	30/120
<b>1SL0551A00</b>	rigid flange 12 modules per row	20/80
<b>1SL0552A00</b>	rigid flange 18 modules per row	20/80



# Switchboards

## Accessories for Europa Series switchboards for industrial applications

### Terminal blocks

The complete terminal blocks are composed of a combination of terminal holders and terminal bars as indicated in the description, with the terminal bars already mounted on terminal holders. Configuration of the complete terminal block is standard. For different requirements (customized terminal block), the terminal holders and bars must be procured separately in the versions indicated in the table.



Code	Description	Box/pack No items
<b>12 490</b>	for switchboards 12764 e 12784 – composed of 12538x2 + 12531x2	10/60
<b>12 491</b>	for switchboards 12768 e 12788 – composed of 12539x2 + 12531x2	10/60
<b>12 492</b>	for switchboards 12772 e 12792 – composed of 12540x1 + 12531x1 + 12532x1	10/40
<b>12 494</b>	for switchboards 12774 e 12794 – composed of 12540x2 + 12533x2	10/40
<b>12 493</b>	for switchboards 12776 e 12796 – composed of 12540x2 + 12534x2	10/40
<b>12 497</b>	for switchboards 12778 e 12798 – composed of 12543x2 + 12535x2	10/40

5

### Terminal holders



Code	For switchboards type	Box/pack No items
<b>12 538</b>	12764 - 12784	12/360
<b>12 539</b>	12768 - 12788	12/360
<b>12 540</b>	12772 - 12774 - 12776 - 12792 12794 - 12796	12/144
<b>12 543</b>	12778 - 12798	12/108

The terminal block is completed by combining the necessary terminal bars to the terminal holders, taking care to keep the terminal bars separate from each other.

### Terminal bars

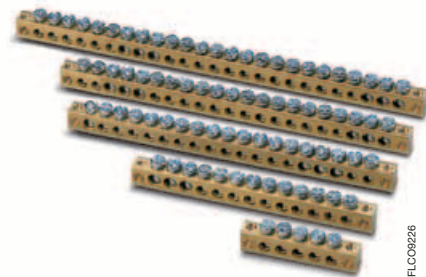

Code	Description No of holes x Ø holes (mm) + No of holes x mm <sup>2</sup>	Box/pack No items
<b>12 531</b>	5x16	20/240
<b>12 532</b>	10x16 + 3x25	20/240
<b>12 533</b>	16x16 + 3x25	20/240
<b>12 534</b>	15x16 + 6x25	20/240
<b>12 535</b>	19x16 + 6x25	20/240

The terminal bars can be installed on any kind of terminal holder; they are snapped onto these with 2 clips for bar, through two holes made at the ends of the bar itself.

Terminal holders and terminal bars are supplied separately. In this way, by inserting one or two terminal bars into the terminal holder you can create the best terminal for your requirements, with the advantage of obtaining a terminal block that is cheap as well as personalised, due to the fact that you only need to use material that is really necessary. Some standard configurations are illustrated in the table.

All the possible configurations that can be created for each type of consumer unit are given in the technical details.

Tertiary/Industrial application



FLCC09858

# Switchboards

## Switchboards for industrial applications with blank front

### Technical characteristics

- protection degree IP 65
- insulation class II
- available in RAL 7035 grey
- available in the versions with transparent, smoky doors
- in polycarbonate material, self-extinguishing and resistant to abnormal heat and fire up to 960 °C (glow wire flammability index) in compliance with IEC 60695-2-11 Standard
- installation temperature from -25 °C to +60 °C
- resistant to heat: ball thermopressure up to +125 °C in compliance with EN 60695-10-2 Standard
- shock resistance 20 Joules (IK level 10)
- perfectly symmetrical switchboards with possibility of hinging the door onto the front (by means of the special articulated screws supplied) on the right or left with 140° opening
- doors designed to take lock with coded key, code 12 866 (page 5/7)
- all models (except for code 13 200) are fitted with one rigid and one bi-material flange for the facilitated insertion of conduits and cables
- switchboards made and produced in compliance with CEI 23-49 (1996) + V1 + V2, CB certificate IEC 60670-24 Standards
- switchboards are supplied complete with:
  - 4 screw-cover caps to guarantee
  - accessories for hinging the front part
  - 1 self-adhesive indicator strip per row
  - 1 certification plate
  - instruction sheet
- use 3.5x9.5 self-tapping screws to fix the components on the back



15LCC001029FC001

# Switchboards

Switchboards for industrial applications with blank front

4 modules

12 modules

12 modules

Transparent, smoky door

RAL 7035 grey



Code	Dimensions (mm) WxHxD	Box/pack No items
<b>13 200</b>	136x540x110	1/8

Code	Dimensions (mm) WxHxD	Box/pack No items
<b>13 204</b>	275x370x140	1/4

Code	Dimensions (mm) WxHxD	Box/pack No items
<b>13 205</b>	275x455x140	1/3

12 modules

18 modules

Transparent, smoky door

RAL 7035 grey



Code	Dimensions (mm) WxHxD	Box/pack No items
<b>13 206</b>	275x570x140	1/3

Code	Dimensions (mm) WxHxD	Box/pack No items
<b>13 208</b>	380x570x140	1/2

# Switchboards

## Accessories for switchboards for industrial applications with blank front

### Terminal blocks

The complete terminal blocks are composed of a combination of terminal holders and terminal bars as indicated in the description, with the terminal bars already mounted on terminal holders. Configuration of the complete terminal block is standard. For different requirements (customized terminal block), the terminal holders and bars must be procured separately in the versions indicated in the table.



Code	Description	Box/pack No items
<b>12 492</b>	for 12 modules – composed of 12540x1 + 12531x1 + 12532x1	10/40
<b>12 498</b>	for 18 modules – composed of 12543x1 + 12531x1 + 12535x1	10/40

### Terminal holders

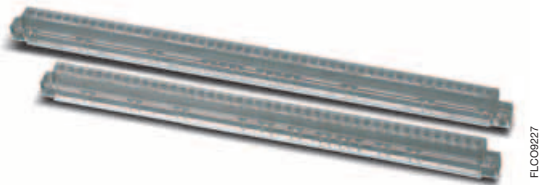

Code	Description	F boards type	Box/pack No items
<b>12 540</b>	for 12 modules	13 204 – 13 205 – 13 206	12/144
<b>12 543</b>	for 18 modules	13 208	12/108

The terminal block is completed by combining the necessary terminal bars to the terminal holders, taking care to keep the terminal bars separate from each other.

### Terminal bars

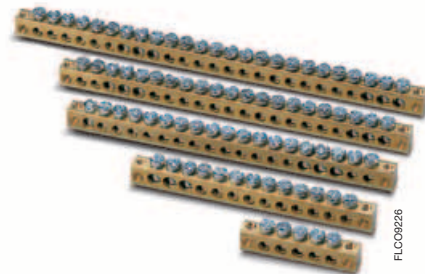

Code	Description	Box/pack No items
	No of holes x Ø holes (mm) + No of holes x mm <sup>2</sup>	
<b>12 531</b>	5x16	20/240
<b>12 532</b>	10x16 + 3x25	20/240
<b>12 533</b>	16x16 + 3x25	20/240
<b>12 534</b>	15x16 + 6x25	20/240
<b>12 535</b>	19x16 + 6x25	20/240

The terminal bars can be installed on any kind of terminal holder; they are snapped onto these with 2 clips per bar, through two holes made at the ends of the bar itself.

Terminal holders and terminal bars are supplied separately. In this way, by inserting one or two terminal bars into the terminal holder you can create the best terminal for your requirements, with the advantage of obtaining a terminal block that is cheap as well as personalised, due to the fact that you only need to use material that is really necessary. Some standard configurations are illustrated in the table.

All the possible configurations that can be created for each type of consumer unit are given in the technical details.



# Switchboards

Accessories for switchboards for industrial applications with blank front

## Semi-flush-mounting frames



Code	For switchboards	
<b>12 598</b>	13 200	5/20
<b>12 593</b>	13 204	5/20
<b>12 599</b>	13 205	5/5
<b>12 594</b>	13 206	5/5
<b>12 595</b>	13 208	5/5

## Universal cutter



Code	Box/pack	No items
<b>12 894</b>		1/30

To use for side branch connections.

## Wall brackets



Code	Description	Box/pack	No items
<b>12 858</b>	in insulating material	20/240	

5



# Switchboards

Accessories for switchboards for industrial applications with blank front

## Module covers



Code	Description	No modules	Box/pack No items
<b>12 861</b>	RAL 7035 grey	1	50/1500
<b>12 863</b>	RAL 7035 grey	4	25/300

## Spare flanges

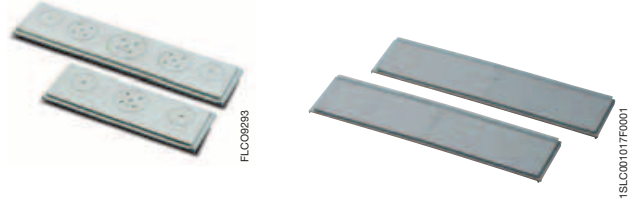

Code	For switchboards type	Box/pack No items
<b>12 601</b>	13 204 – 13 205 – 13 206, bi-material	20/80
<b>12 602</b>	13 208, bi-material	20/80
<b>1SL0551A00</b>	rigid flange 12 modules per row	20/80
<b>1SL0552A00</b>	rigid flange 18 modules per row	20/80

## Key lock



Code	Description	Box/pack No items
<b>12 866</b>	coded type	10/300





## Index

### IP 44 and IP 55 boxes

IP44 and IP55 junction boxes in thermoplastic material with press-on lid .....6/3

### IP 44, IP 55 and IP 65 boxes

IP 44, IP 55 and IP 65 junction boxes in thermoplastic material.....6/5

### IP 65 boxes

IP 65 junction boxes in polycarbonate.....6/13

### Empty enclosures IP 40 and IP 65

IP 40 and IP 55 equipment and empty enclosures .....6/19

Tertiary/Industrial application



FLC09811

# Boxes, equipment and various components

## IP44 and IP55 junction boxes in thermoplastic material with press-on lid

### Technical characteristics

- Protection degree
    - IP44 for press-on lid boxes with cable glands
    - IP55 for screw-on lid boxes with cable glands
    - IP55 for screw-on lid box with smooth sides
  - Available in RAL 7035 grey
  - IP44 boxes with press-on lids in thermoplastic material, self-extinguishing in compliance with UL 94 HB Standard and resistant to abnormal heat and fire up to 650°C (glow wire flammability index) in compliance with IEC 60695-2-11 Standard
  - IP55 boxes with press-on lids and cable glands in thermoplastic material, self-extinguishing in compliance with UL 94 HB Standard and resistant to abnormal heat and fire up to 650°C (glow wire flammability index) in compliance with IEC 60695-2-11 Standard
  - IP55 boxes with press-on lids and smooth sides in halogen free thermoplastic material, self-extinguishing in compliance with UL 94 HB Standard and resistant to abnormal heat and fire up to 650°C (glow wire flammability index) in compliance with IEC 60695-2-11 Standard
- Installation temperature from -25°C to +60°C
  - Resistant to heat:
    - ball thermopressure up to +85°C
  - Shock resistant:
    - IK08 for IP55 and IP65 boxes with 650°C GWT
  - High resistance to heat and chemical and atmospheric agents
  - Boxes with protection degree IP55 are composed of a patented lid produced in a single pressing phase together with its seal
  - All the boxes with cable-way inlets are suitable to be installed with mini-trunking by using special connectors ABB
  - When fitted with special housings, the base of the box can be equipped with terminals and various accessories
- Junction boxes made in compliance with IEC 60670-1 and IEC 60670-22 Standards
  - Use 3,5x9,5 self-tapping screws to fix the components on the back
  - All the boxes are RoHS compliance

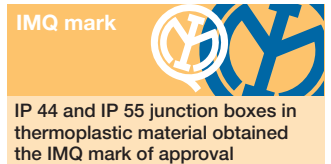
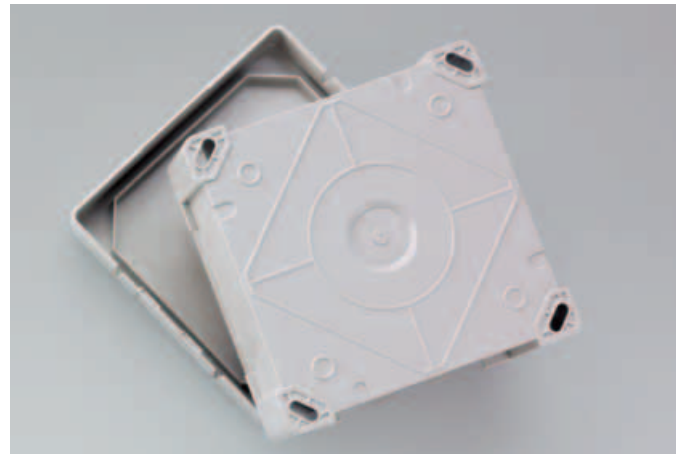

## Boxes, equipment and various components

IP44 and IP55 junction boxes in thermoplastic material with press-on lid

### Box 100x100x50

With press-on lids 100x100x50

With press-on lids 100x100x50



Code	Degree of protection	Description
<b>1SL0811A00</b>	IP44	with cable glands
<b>1SL0890A00</b>	IP55	with cable glands

Code	Degree of protection	Description
<b>1SL0891A00</b>	IP55	with smooth sides



# Boxes, equipment and various components

## IP44, IP55 and IP65 junction boxes in thermoplastic material

### Technical characteristics

- Protection degree
    - IP44 for press-on lid boxes with cable glands
    - IP55 for screw-on lid boxes with cable glands
    - IP65 for screw-on lid box with smooth sides
  - Available in RAL 7035 grey
  - IP44 boxes with press-on lids in thermoplastic material, self-extinguishing in compliance with UL 94 HB Standard and resistant to abnormal heat and fire up to 650°C (glow wire flammability index) in compliance with IEC 60695-2-11 Standard
  - IP44 boxes with press-on lids in thermoplastic material, self-extinguishing in compliance with UL 94 V2 Standard and resistant to abnormal heat and fire up to 960°C (glow wire flammability index) in compliance with IEC 60695-2-11 Standard
  - IP55 boxes with screw-on lids in thermoplastic material, self-extinguishing in compliance with UL 94 HB Standard and resistant to abnormal heat and fire up to 650°C (glow wire flammability index) in compliance with IEC 60695-2-11 Standard
  - IP55 boxes with screw-on lids in thermoplastic material, self-extinguishing in compliance with UL 94 V2 Standard and resistant to abnormal heat and fire up to 960°C (glow wire flammability index) in compliance with IEC 60695-2-11 Standard
  - IP65 boxes with screw-on lids in **halogen free** thermoplastic material, self-extinguishing in compliance with UL 94 HB Standard and resistant to abnormal heat and fire up to 650°C (glow wire flammability index) in compliance with IEC 60695-2-11 Standard
  - IP65 boxes with screw-on lids in thermoplastic material, self-extinguishing in compliance with UL 94 V2 Standard
- and resistant to abnormal heat and fire up to 960°C (glow wire flammability index) in compliance with IEC 60695-2-11 Standard
- Installation temperature from -25°C to +60°C
  - Resistant to heat:
    - ball thermopressure up to +85°C for IP44 boxes with 650°C and 960°C GWT
    - ball thermopressure up to +85°C for IP55 and IP65 boxes with 650°C GWT
    - ball thermopressure up to +120°C for IP55 and IP65 boxes with 960°C GWT
  - Shock resistant:
    - IK07 for IP44 boxes
    - IK08 for IP55 and IP65 boxes with 650°C GWT
    - IK09 for IP55 and IP65 boxes with 960°C GWT
  - High resistance to heat and chemical and atmospheric agents
  - 3 lid types:
    - press-on
    - with steel screws
    - with plastic screws with a ¼ turn closing
  - Boxes with protection degree IP55 and IP65 are composed of a patented lid produced in a single pressing phase together with its seal
  - All the boxes with cable-way inlets are suitable to be installed with mini-trunking by using special connectors ABB
  - When fitted with special housings, the base of the box can be equipped with terminals and various accessories
  - Boxes measuring 160x135, 220x170 and 310x240 mm can be mounted on the wall with brackets code 12858
  - Junction boxes made in compliance with IEC 60670-1 and IEC 60670-22 Standards
  - Use 3,5x9,5 self-tapping screws to fix the components on the back
  - All the boxes are RoHS compliance



1SLCC01089F0001



1SLCC01089F0001

IMQ mark



IP 44 and IP 55 junction boxes in thermoplastic material obtained the IMQ mark of approval

# Boxes, equipment and various components

## IP 44, IP 55 and IP 65 junction boxes in thermoplastic material

### IP 44 boxes - GWT 650 °C

With cable glands and press-on lid



Code	Internal dimensions (mm)	Box/pack No items
<b>00 800</b>	Ø 60 - H 35	240/240
<b>00 802</b>	Ø 80 - H 40	144/144
<b>00 808</b>	65x65x32	168/168
<b>00 810</b>	80x80x40	100/100

6

### IP 55 waterproof boxes with plastic 1/4 turn screws - GWT 650 °C

With cable glands and low screw-on lid RAL 7035



Code	Internal dimensions (mm)	Box/pack No items
<b>1SL0816A00</b>	100x100x50	1/54
<b>1SL0820A00</b>	105x70x50	1/70
<b>1SL0821A00</b>	100x100x80	1/40
<b>1SL0822A00</b>	153x110x66	1/32
<b>1SL0824A00(*)</b>	160x135x77	1/18
<b>1SL0826A00(*)</b>	220x170x80	1/12
<b>1SL0828A00(*)</b>	310x240x110	1/6

(\*) Can be wall-mounted using wall brackets code 12 858.

### IP 65 waterproof boxes with plastic 1/4 turn screws - GWT 650 °C halogen free

With smooth sides and low screw-on lid RAL 7035

With smooth sides and transparent low screw-on lid



Code	Internal dimensions (mm)	Box/pack No items
<b>1SL0846A00</b>	100x100x50	1/60
<b>1SL0850A00</b>	105x70x50	1/100
<b>1SL0851A00</b>	100x100x80	1/40
<b>1SL0852A00</b>	153x110x66	1/32
<b>1SL0854A00(*)</b>	160x137x77	1/24
<b>1SL0856A00(*)</b>	220x170x80	1/12
<b>1SL0858A00(*)</b>	310x240x110	1/6

(\*) Can be wall-mounted using wall brackets code 12 858.



Code	Internal dimensions (mm)	Box/pack No items
<b>1SL0872A00</b>	153x110x66	1/34
<b>1SL0874A00(*)</b>	160x135x77	1/24
<b>1SL0876A00(*)</b>	220x170x80	1/12
<b>1SL0878A00(*)</b>	310x240x110	1/6

(\*) Can be wall-mounted using wall brackets code 12 858.

# Boxes, equipment and various components

## IP 44, IP 55 and IP 65 junction boxes in thermoplastic material

### IP 55 waterproof boxes with steel screws - GWT 650 °C

With cable glands and high screw-on lid RAL 7035



FLC09198

Code	Internal dimensions (mm)	Box/pack No items
<b>00 816</b>	100x100x50	1/54
<b>00 820</b>	105x70x50	1/70
<b>00 821</b>	100x100x80	1/40
<b>00 822</b>	153x110x66	1/32

### IP 65 waterproof boxes with steel screws - GWT 650 °C halogen free

With smooth sides and high screw-on lid RAL 7035



FLC09204

Code	Internal dimensions (mm)	Box/pack No items
<b>00 846</b>	100x100x50	1/60
<b>00 850</b>	105x70x50	1/100
<b>00 851</b>	100x100x80	1/40
<b>00 852</b>	153x110x66	1/34

With smooth sides and transparent high screw-on lid



1SLC001031F001

Code	Internal dimensions (mm)	Box/pack No items
<b>00 872</b>	151x110x66	1/34

### IP 55 waterproof boxes with plastic 1/4 turn screws - GWT 650 °C

With cable glands and high screw-on lid RAL 7035



1SLC001088F001

Code	Internal dimensions (mm)	Box/pack No items
<b>1SL0830A00</b>	160x135x150	1/16
<b>1SL0832A00</b>	220x170x150	1/8
<b>1SL0834A00</b>	310x240x160	1/4

### IP 65 waterproof boxes with plastic 1/4 turn screws - GWT 650 °C halogen free

With smooth sides and high screw-on lid RAL 7035



1SLC001087F001

Code	Internal dimensions (mm)	Box/pack No items
<b>1SL0860A00</b>	160x135x150	1/16
<b>1SL0862A00</b>	220x170x150	1/8
<b>1SL0864A00</b>	310x240x160	1/4

With smooth sides and transparent high screw-on lid



1SLC001088F001

Code	Internal dimensions (mm)	Box/pack No items
<b>1SL0880A00(*)</b>	160x135x150	1/16
<b>1SL0882A00(*)</b>	220x170x150	1/8
<b>1SL0884A00(*)</b>	310x240x160	1/4

(\*) Can be wall-mounted using wall brackets code 12 858.

# Boxes, equipment and various components

## IP 44, IP 55 and IP 65 junction boxes in thermoplastic material

### IP 44 boxes - GWT 960 °C

With cable glands and press-on lid

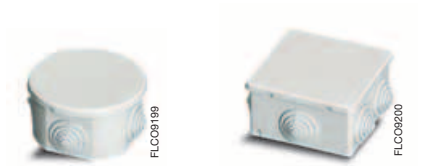

Code	Internal dimensions (mm)	Box/pack No items
<b>1SL0900A00</b>	Ø 60 - H 35	240/240
<b>1SL0901A00</b>	Ø 80 - H 40	144/144
<b>1SL0902A00</b>	65x65x32	168/168
<b>1SL0903A00</b>	80x80x40	100/100

6

### IP 55 waterproof boxes with plastic 1/4 turn screws - GWT 960 °C

With cable glands and low screw-on lid RAL 7035



Code	Internal dimensions (mm)	Box/pack No items
<b>1SL0916A00</b>	100x100x50	1/54
<b>1SL0920A00</b>	105x70x50	1/70
<b>1SL0921A00</b>	100x100x80	1/40
<b>1SL0922A00</b>	153x110x66	1/32
<b>1SL0924A00(*)</b>	160x135x77	1/18
<b>1SL0926A00(*)</b>	220x170x80	1/12
<b>1SL0928A00(*)</b>	310x240x110	1/6

(\*) Can be wall-mounted using wall brackets code 12 858.

### IP 65 waterproof boxes with plastic 1/4 turn screws - GWT 960 °C

With smooth sides and low screw-on lid RAL 7035

With smooth sides and transparent low screw-on lid



Code	Internal dimensions (mm)	Box/pack No items
<b>1SL0946A00</b>	100x100x50	1/60
<b>1SL0950A00</b>	105x70x50	1/100
<b>1SL0951A00</b>	100x100x80	1/40
<b>1SL0952A00</b>	153x110x66	1/32
<b>1SL0954A00(*)</b>	160x137x77	1/24
<b>1SL0956A00(*)</b>	220x170x80	1/12
<b>1SL0958A00(*)</b>	310x240x110	1/6

(\*) Can be wall-mounted using wall brackets code 12 858.

Code	Internal dimensions (mm)	Box/pack No items
<b>1SL0972A00</b>	153x110x66	1/34
<b>1SL0974A00(*)</b>	160x135x77	1/24
<b>1SL0976A00(*)</b>	220x170x80	1/12
<b>1SL0978A00(*)</b>	310x240x110	1/6

(\*) Can be wall-mounted using wall brackets code 12 858.

# Boxes, equipment and various components

## IP 44, IP 55 and IP 65 junction boxes in thermoplastic material

### IP 55 waterproof boxes with steel screws - GWT 960 °C

With cable glands and high screw-on lid RAL 7035



FLC09198

Code	Internal dimensions (mm)	Box/pack No items
<b>1SL0904A00</b>	100x100x50	1/54
<b>1SL0905A00</b>	105x70x50	1/70
<b>1SL0906A00</b>	100x100x80	1/40
<b>1SL0907A00</b>	153x110x66	1/32

### IP 65 waterproof boxes with steel screws - GWT 960 °C

With smooth sides and high screw-on lid RAL 7035



FLC09204

Code	Internal dimensions (mm)	Box/pack No items
<b>1SL0908A00</b>	100x100x50	1/60
<b>1SL0909A00</b>	105x70x50	1/100
<b>1SL0910A00</b>	100x100x80	1/40
<b>1SL0911A00</b>	153x110x66	1/34

With smooth sides and transparent high screw-on lid



1SLC091031F001

Code	Internal dimensions (mm)	Box/pack No items
<b>1SL0912A00</b>	151x110x66	1/34

### IP 55 waterproof boxes with plastic 1/4 turn screws - GWT 960 °C

With cable glands and high screw-on lid RAL 7035



1SLC091088F001

Code	Internal dimensions (mm)	Box/pack No items
<b>1SL0930A00</b>	160x135x150	1/16
<b>1SL0932A00</b>	220x170x150	1/8
<b>1SL0934A00</b>	310x240x160	1/4

### IP 65 waterproof boxes with plastic 1/4 turn screws - GWT 960 °C

With smooth sides and high screw-on lid RAL 7035



1SLC091087F001

Code	Internal dimensions (mm)	Box/pack No items
<b>1SL0960A00</b>	160x135x150	1/16
<b>1SL0962A00</b>	220x170x150	1/8
<b>1SL0964A00</b>	310x240x160	1/4

With smooth sides and transparent high screw-on lid



1SLC091088F001

Code	Internal dimensions (mm)	Box/pack No items
<b>1SL0980A00(*)</b>	160x135x150	1/16
<b>1SL0982A00(*)</b>	220x170x150	1/8
<b>1SL0984A00(*)</b>	310x240x160	1/4

(\*) Can be wall-mounted using wall brackets code 12 858.

# Boxes, equipment and various components

## Accessories for IP 44, IP 55 and IP 65 junction boxes in thermoplastic material

### Cable glands and nuts - PG pitch



FLC00291



FLC00267

Code		Pitch	Torque values N x m	Cable clamp Box/pack No items	For cables diameter		Nuts x cable Box/pack No items
cable gland	nut x cable gland	Pg			Min. (mm)	Max. (mm)	
<b>00 931</b>	<b>00 941</b>	9	3.75	100/500	6.5	8.5	100/3000
<b>00 932</b>	<b>00 942</b>	11	3.75	100/500	8	10	100/3000
<b>00 933</b>	<b>00 943</b>	13.5	3.75	50/500	8	11	50/1500
<b>00 934</b>	<b>00 944</b>	16	5	50/300	11	14	50/1500
<b>00 935</b>	<b>00 945</b>	21	7.5	50/300	14.5	18	50/1500
<b>00 936</b>	<b>00 946</b>	29	7.5	25/150	19	26	50/600
<b>00 937</b>	<b>00 947</b>	36	7.5	25/75	30	34	25/300
<b>00 938</b>	<b>00 948</b>	42	7.5	15/60	30	38	25/300

In compliance with CEI EN 50262 Standard.

### Cable glands and nuts - metric pitch



1SLC001033F0001



1SLC001033F0001

Code		Pitch	Torque values N x m	Cable diameter		Box/pack No items	Cable clamp Box/pack No items
cable gland	nut	M		Min. (mm)	Max. (mm)		
<b>00 951</b>	<b>00 961</b>	12 x 1.5	2.7	3.5	7	100/1200	100/3000
<b>00 952</b>	<b>00 962</b>	16 x 1.5	5	5.5	10	100/500	100/3000
<b>00 953</b>	<b>00 963</b>	20 x 1.5	7	7	13	100/500	50/1500
<b>00 954</b>	<b>00 964</b>	25 x 1.5	7.5	10	17	50/250	50/1500
<b>00 955</b>	<b>00 965</b>	32 x 1.5	8	12	21	25/150	50/500
<b>00 956(*)</b>	<b>00 966</b>	40 x 1.5	8	19	28	25/75	25/300
<b>00 957(*)</b>	<b>00 967</b>	50 x 1.5	10	27	35	15/60	25/300
<b>00 958(*)</b>	<b>00 968</b>	63 x 1.5	10	34	45	10/40	20/100

(\*) Cable clamps and M40, M50 and M63 nuts are available on request.  
In compliance with CEI EN 50262 Standard.

#### Technical characteristics of metric cable clamps

Protection degree IP 68  
Material: polyamide 6.6, self-extinguishing material according to UL94 V2 Standard and resistant to abnormal heat and to fire up to 750 °C (glow wire test) according to IEC 60695-2-11 Standard  
Operational temperature: from -20 °C up to +120 °C (short period of time)  
Colour: RAL 7035 grey  
Thread pitch: 1.5 mm  
Thread angle: 60°  
Neoprene seal  
Tightening with a plate crown on the whole diameter of cable (excluded the possibility to damage the cable itself)  
Possibility to recover the cable clamp without compromising its efficiency.

#### Technical characteristics nuts of with metric pitch collar

Material: polyamide 6.6, self-extinguishing material according to UL94 V2 Standard and resistant to abnormal heat and to fire up to 750 °C (glow wire test) according to IEC 60695-2-11 Standard  
Operational temperature: from -20 °C up to +120 °C (continuous)  
from -20 °C up to +120 °C (short period of time)  
Colour: RAL 7035 grey  
Thread pitch: 1.5 mm  
Thread angle: 60°.



# Boxes, equipment and various components

## Accessories for IP 44, IP 55 and IP 65 junction boxes in thermoplastic material

### Metal base plates

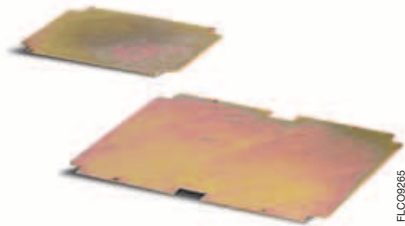

Code	Dimensions (mm)	Box/pack No items
<b>00 900</b>	160 x 135 x 77	1/10
<b>00 902</b>	220 x 170 x 80	1/5
<b>00 904</b>	310 x 240 x 110	1/5

All metal base plates listed above are equipped with fixing screws type 3.5x9.5.

### Cable clamps

Protection degree: IP 55



Code	For conduit Ø (mm)	Box/pack No items
<b>00 908</b>	20	100/1500
<b>00 910</b>	25	100/1000
<b>00 912</b>	32	50/400

### Conduit clamps - Box connector

Protection degree: IP 67



Code	For conduit Ø (mm)	Box/pack No items
<b>00 430</b>	16	500/500
<b>00 431</b>	20	300/300
<b>00 432</b>	25	150/150
<b>00 433</b>	32	100/100
<b>00 434</b>	40	50/50
<b>00 435</b>	50	50/50

### Unions

Protection degree: IP 55



Code	Ø (mm)	Box/pack No items
<b>13 874</b>	23	10/500
<b>13 875</b>	28.5	100/400
<b>13 876</b>	37	100/200

Tertiary/Industrial application





FLO09812

**DEMAG  
SACK**  
SENDZIMIR  
2R220-5A 100

# Boxes, equipment and various components

## IP 65 junction boxes in polycarbonate

### Technical characteristics

- protection degree IP 65
- insulation class II 
- available in RAL 7035 grey
- in **polycarbonate** material, self-extinguishing and resistant to abnormal heat and fire up to 960 °C (glow wire test) in compliance with IEC 60695-2-11 Standard
- installation temperature from -25 °C to +60 °C
- resistant to heat: ball thermopressure up to +125 °C in compliance with EN 60695-10-2 Standard
- rated insulation voltage: 1000 V AC; 1500 V DC
- shock resistance 20 Joules (IK level 10)
- perfectly symmetrical junction boxes with possibility of attaching the lid hinges, (using the special articulated screws supplied) on the right or left with 140° opening
- boxes code 12 808, 12 812, 12 814, 12 816 and 12 818 fitted with one rigid and one bi-material flange for facilitated input of conduits and cables
- junction boxes produced in compliance with CEI 23-49 (1996) + V1 + V2, CB certificate IEC 60670-24 Standards
- boxes are supplied complete with:
  - 4 screw-cover caps to guarantee 
  - accessories for attaching the hinges on the front
  - 1 certification plate
  - instruction sheet
- use 3.5x9.5 self-tapping screws to fix the components on the back



# Boxes, equipment and various components

## IP 65 junction boxes in polycarbonate

140x220x140 mm



Code	Dimensions (mm) WxHxD	Box/pack No items
<b>12 804</b>	140x220x140	1/14

205x220x140 mm



Code	Dimensions (mm) WxHxD	Box/pack No items
<b>12 808</b>	205x220x140	1/9

275x220x140 mm



Code	Dimensions (mm) WxHxD	Box/pack No items
<b>12 812</b>	275x220x140	1/6

6

275x370x140 mm



Code	Dimensions (mm) WxHxD	Box/pack No items
<b>12 814</b>	275x370x140	1/4

275x570x140 mm



Code	Dimensions (mm) WxHxD	Box/pack No items
<b>12 816</b>	275x570x140	1/2

380x570x140 mm



Code	Dimensions (mm) WxHxD	Box/pack No items
<b>12 818</b>	380x570x140	1/2

# Boxes, equipment and various components

## Accessories for IP 65 junction boxes in polycarbonate

### Base plates

In aluminium-plated metal



Code	For boxes type	Box/pack No items
<b>12 842</b>	12 804	10/120
<b>12 844</b>	12 808	10/10
<b>12 845</b>	12 812	10/10
<b>12 846</b>	12 814	5/5
<b>12 847</b>	12 816	5/5
<b>12 848</b>	12 818	5/5

### Base plates

Protection degree: IP 67



Code	For boxes type	Box/pack No items
<b>12 832</b>	12 804	10/10
<b>12 834</b>	12 808	10/10
<b>12 835</b>	12 812	10/10
<b>12 836</b>	12 814	5/5
<b>12 837</b>	12 816	5/5
<b>12 838</b>	12 818	5/5

6

### DIN metal section bars

Complete with screws



Code	For boxes type	Box/pack No items
<b>12 852</b>	12 804	50/600
<b>12 854</b>	12 808	30/360
<b>12 855</b>	12 812 – 12 814 – 12 816	50/200
<b>12 856</b>	12 818	50/200

### Wall brackets



Code	Description	Box/pack No items
<b>12 858</b>	in insulating material	20/240

# Boxes, equipment and various components

## Accessories for IP 65 junction boxes in polycarbonate

### Terminal blocks

The complete terminal blocks are composed of a combination of terminal holders and terminal bars as indicated in the description, with the terminal bars already mounted on terminal holders. Configuration of the complete terminal block is standard. For different requirements (customized terminal block), the terminal holders and bars must be procured separately in the versions indicated in the table.



Code	Description	Box/pack No items
<b>12 490</b>	for box 12804 – composed of 12538x2 + 12531x2	10/60
<b>12 491</b>	for box 12808 – composed of 12539x2 + 12531x2	10/60
<b>12 492</b>	for box 12812 – composed of 12540x1 + 12531x1 + 12532x1	10/40
<b>12 494</b>	for box 12814 – composed of 12540x2 + 12533x2	10/40
<b>12 493</b>	for box 12816 – composed of 12540x2 + 12534x2	10/40
<b>12 497</b>	for box 12818 – composed of 12543x2 + 12535x2	10/40

### Terminal holders



### Terminal bars

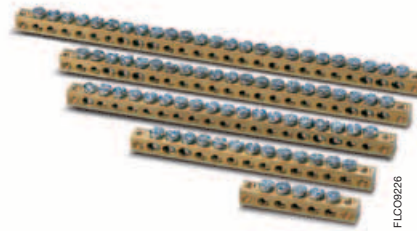

Code	For boxes type	Box/pack No items
<b>12 538</b>	12 804	12/360
<b>12 539</b>	12 808	12/360
<b>12 540</b>	12 812 – 12 814 – 12 816	12/144
<b>12 543</b>	12 818	12/108

The terminal block is completed by combining the necessary terminal bars to the terminal holders, taking care to keep the terminal bars separated from each other.

Code	Description No of holes x Ø holes (mm) + No of holes x mm <sup>2</sup>	Box/pack No items
<b>12 531</b>	5x16	20/240
<b>12 532</b>	10x16 + 3x25	20/240
<b>12 533</b>	16x16 + 3x25	20/240
<b>12 534</b>	15x16 + 6x25	20/240
<b>12 535</b>	19x16 + 6x25	20/240

The terminal bars can be installed on any kind of terminal holder; they are snapped onto these with 2 clips per bar, through two holes made at the ends of the bar itself.



# Boxes, equipment and various components

## Accessories for IP 65 junction boxes in polycarbonate

### Spare flanges

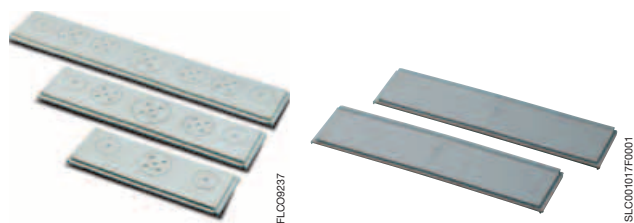

Code	For boxes type	Box/pack No items
<b>12 600</b>	12 808, bi-material	30/120
<b>12 601</b>	12 812 – 12 814 – 12 816, bi-material	20/80
<b>12 602</b>	12 818, bi-material	20/80
<b>1SL0550A00</b>	rigid flange, 8 modules per row	30/120
<b>1SL0551A00</b>	rigid flange, 12 modules per row	20/80
<b>1SL0552A00</b>	rigid flange, 18 modules per row	20/80

### Semi-flush-mounting frames



Code	For boxes type	Box/pack No items
<b>12 590</b>	12 804	5/20
<b>12 591</b>	12 808	5/20
<b>12 592</b>	12 812	5/20
<b>12 593</b>	12 814	5/20
<b>12 594</b>	12 816	5/5
<b>12 595</b>	12 818	5/5

6

### Universal cutter

For drill



Code	Box/pack No items
<b>12 894</b>	1/30

To be used for side branch connections.

Residential/tertiary/industrial application



# Boxes, equipment and various components

## IP 40 and IP 55 equipment and empty enclosures

### IP 40 equipment and empty enclosures

#### Technical characteristics

- IP 40 equipment and empty enclosures composed of base and cover, joined with safety screws with bivalent slotted head in stainless steel
- equipment and empty enclosures with cable gland on the top
- equipment and empty enclosures designed to be installed with conduits and, using special accessories, with mini-trunkings ABB
- empty enclosures suitable for:
  - wiring accessories in the Élos Soft/Élos Smart series
  - wiring accessories in the Chiara series
- protection degree IP 40
- enclosures available in **RAL 7035 grey**
- in **thermoplastic** material, self-extinguishing and resistant to abnormal heat and fire up to 650 °C (glow wire test) in compliance with IEC 60695-2-11 Standard
- installation temperature from -25 °C to +60 °C
- resistant to heat: ball thermopressure up to +85 °C in compliance with EN 60695-10-2 Standard
- empty enclosures made in compliance with CEI 23-48 and IEC 670 Standards
- enclosures equipped with control devices made in compliance with CEI 23-9 Standard
- enclosures equipped with bypass sockets made in compliance with CEI 23-50 Standard

### IP 55 equipment and empty enclosures

#### Technical characteristics

- IP 55 equipment and empty enclosures composed of base and cover, joined with safety screws with bivalent slotted head in stainless steel
- equipment and empty enclosures fitted with seal between the base and the cover; lid with transparent elastic membrane so that controls can be used even when the lid is closed
- equipment and empty enclosures with cable gland on the top
- equipment and empty enclosures designed to be installed with conduits and, using special accessories, with mini-trunkings ABB
- empty enclosures suitable for:
  - wiring accessories in the Élos Soft/Élos Smart series
  - wiring accessories in the Chiara series
- protection degree IP 55
- containers available in **RAL 7035 grey**
- in **thermoplastic** material, self-extinguishing and resistant to abnormal heat and fire up to 650 °C (glow wire test) in compliance with IEC 60695-2-11 Standard
- installation temperature from -25 °C to +60 °C
- resistant to heat: ball thermopressure up to +85 °C in compliance with EN 60695-10-2 Standard
- empty enclosures made in compliance with CEI 23-48 and IEC 670 Standards
- enclosures equipped with control equipment made in compliance with CEI 23-9 Standard
- enclosures equipped with bypass sockets made in compliance with CEI 23-50 Standard
- lid/cover opening angle: 120°



# Boxes, equipment and various components

## IP 40 and IP 55 equipment and empty enclosures

### IP 40 equipment

For ABB Élos Soft/Smart wiring accessories series

For ABB Chiara wiring accessories series

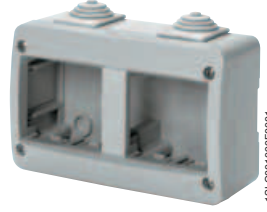
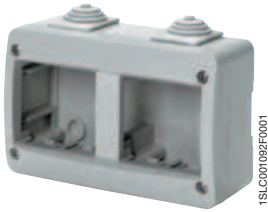

Code	Description	Box/pack No items
<b>2CSE2240EL</b>	2 compartments enclosure	10/40
<b>2CSE2340EL</b>	3 compartments enclosure	10/30
<b>2CSE2440EL</b>	4 compartments enclosure	10/20
<b>2CSE2840EL</b>	8 compartments enclosure	5/10

Code	Description
<b>2CSK2140CH</b>	1 compartment enclosure, 2 modules
<b>2CSK2240CH</b>	2 compartments enclosure, 2 modules
<b>2CSK2340CH</b>	3 compartments enclosure, 3 modules
<b>2CSK2440CH</b>	4 compartments enclosure, 4 modules

6

### IP 55 equipment

For ABB Élos Soft/Smart wiring accessories series

For ABB Chiara wiring accessories series



Code	Description	Box/pack No items
<b>2CSE2255EL</b>	2 compartments enclosure	10/40
<b>2CSE2355EL</b>	3 compartments enclosure	10/30
<b>2CSE2455EL</b>	4 compartments enclosure	10/20
<b>2CSE2855EL</b>	8 compartments enclosure	5/10

Code	Description
<b>2CSK2155CH</b>	1 compartment enclosure, 2 modules
<b>2CSK2255CH</b>	2 compartments enclosure, 2 modules
<b>2CSK2355CH</b>	3 compartments enclosure, 3 modules
<b>2CSK2455CH</b>	4 compartments enclosure, 4 modules



## **Index**

Enclosures and boxes for light prefabrication.....	7/3
Wiring accessories and junction boxes in thermoplastic material .....	7/7



Residential/tertiary application

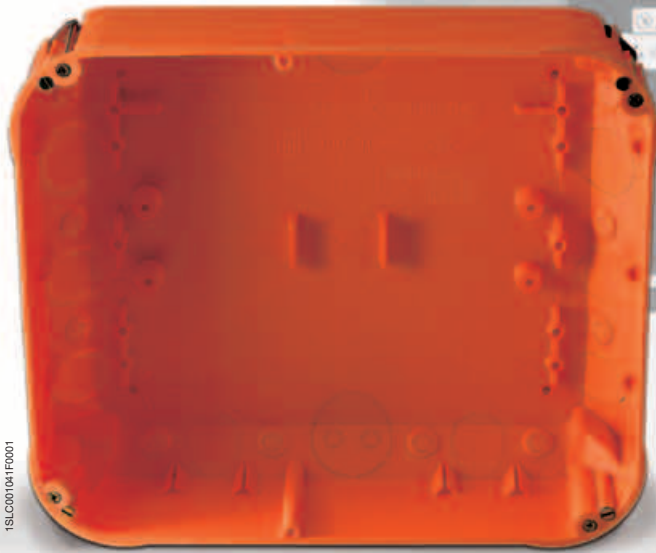

1SLC001041F0001





# Wiring accessories and junction boxes

## Enclosures and boxes for light prefabrication

### Technical characteristics

- execution in self-extinguishing thermoplastic material
- IP 40
- installation on plastered panels, of masonite, and so on, of 7- 35 mm thickness



# Wiring accessories and junction boxes

## Enclosures and boxes for light prefabrication

### Junction boxes

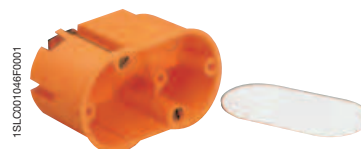
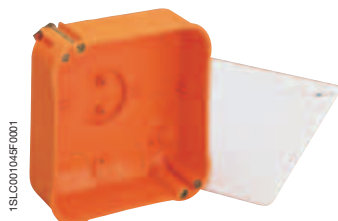

Code	Description	Box/pack No items
<b>10 801</b>	wiring accessories box Ø 60 mm, P 45 mm(*)	1/75
<b>10 807</b>	wiring accessories box Ø 60 mm, P 35 mm(*)	1/100
<b>10 802</b>	wiring accessories and junction box Ø 60 mm, P 61 mm(*)	1/50
<b>10 803</b>	junction box increased with lid Ø 74 mm, P 50 mm(*)	1/60

Code	Description	Box/pack No items
<b>10 808</b>	junction box with lid W 100 mm x H 100 mm x D 45 mm(*)	1/36
<b>10 811</b>	box lid 10808, with 2 fixing screws	10/540

Code	Description	Box/pack No items
<b>10 804</b>	wiring accessories modular box W 100 mm x H 62 mm x D 40 mm(*)	1/85
<b>10 805</b>	wall light box with lid W 65 mm x H 35 mm x D 40 mm(*)	1/100

(\*) To make the holes, use ABB cutters:

- cutter code 10840 for boxes code 10808 and 10805
- cutter code 10841 for boxes item code 10801, 1807 and 10802
- cutter code 10842 for boxes code 10803
- cutter code 10843 for boxes code 10804

### 7 Boxes for consumer units



Code	Description	Box/pack No items
<b>10 821</b>	box for consumer units 8 modules W 160 mm x H 160 mm x D 65 mm	1/10
<b>10 822</b>	box for consumer units 12 modules W 235 mm x H 205 mm x D 70 mm	1/7
<b>10 831</b>	lid in plastic material for box 10821, with 4 fixing screws	10/200
<b>10 832</b>	lid in plastic material for box 10822, with 4 fixing screws	5/100

### Fronts for consumer units with polycarbonate transparent smoky

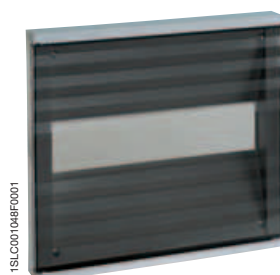

Code	Description	Box/pack No items
<b>10 833</b>	RAL 7035 grey fronts for consumer unit 8 modules with DIN rail and fixing screws	1/20
<b>10 834</b>	RAL 7035 grey fronts for consumer unit 12 modules with DIN rail and fixing screws	1/12

# Wiring accessories and junction boxes

## Accessories for enclosures and boxes for light prefabrication

### Cutters



1SLC001049F0001

Code	Description	Box/pack No items
<b>10 840</b>	cutter with marginal countersink Ø 35 mm, H adjustable (*)	1
<b>10 841</b>	cutter with marginal countersink Ø 68 mm, H adjustable (*)	1
<b>10 842</b>	cutter with marginal countersink Ø 74 mm, H adjustable (*)	1
<b>10 843</b>	cutter with marginal countersink Ø 62 mm, H 18 mm	1

(\*) Adjustable for execution of holes in panels of 7 – 20 mm in thickness.

### Spare ribs for cutters



1SLC001056F0001

Code	Description	Box/pack No items
<b>10 844</b>	spare rib for cutter 10840, H 18 mm	10/120
<b>10 845</b>	spare rib for cutter 10841, H 18 mm	9/108
<b>10 846</b>	spare rib for cutter 10842, H 18 mm	9/108

### Spare marginal countersinks for cutters



1SLC001051F0001

Code	Description	Box/pack No items
<b>10 847</b>	marginal countersink for cutter 10840	10/120
<b>10 848</b>	marginal countersink for cutter 10841	10/120
<b>10 849</b>	marginal countersink for cutter 10842	10/120
<b>10 850</b>	marginal countersink for cutter 10843	10/120

### Helicoidal point



1SLC001052F0001

Code	Description	Box/pack No items
<b>10851</b>	helical point with hexagonal queue Ø 8 mm	1/10

7

Residential/tertiary application



FLO09845

---

# Wiring accessories and junction boxes

## Wiring accessories and junction boxes in thermoplastic material

---

### Technical characteristics

- in thermoplastic material self-extinguishing and resistant to abnormal heat and fire up to 650 °C (glow wire test) in compliance with IEC 60695-2-11 Standard
- large push-in windows
- lid in RAL 9016 with self-threaded screws included in the supply
- operating temperature from -5 °C to +60 °C
- wiring accessories and junction boxes made in compliance with CEI EN 60670-1 and CEI EN 60670-22 Standards
- new enlarged box for 3 modules with new accessories (mortar cover, spacer, separator)

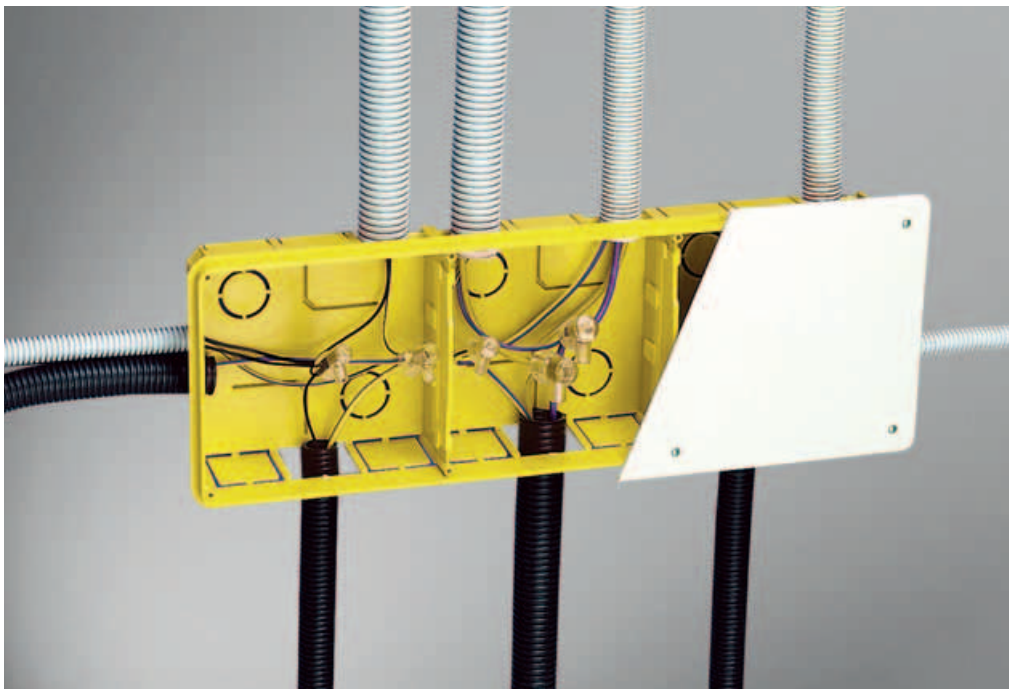

FLCC0915

# Wiring accessories and junction boxes

## Wiring accessories and junction boxes in thermoplastic material

### Truncated-conical box for wiring



Code	Description	Box/pack No items
<b>00 050</b>	truncated-conical box Ø 65 mm	350/350

### Round box for wiring accessories



Code	Description	Box/pack No items
<b>00 051</b>	round box Ø 85 mm	230/230

### Rectangular for wiring accessories



Code	Description	Box/pack No items
<b>1SL0060A00</b>	rectang. box 3 wiring accessories MAXI inter. 83.5 mm	10/400
<b>1SL0061A00</b>	protective cover for box 1SL0060A00	20/90
<b>1SL0062A00</b>	spacer for box 1SL0060A00	20/200
<b>1SL0063A00</b>	separator for box 1SL0060A00	100/100
<b>00 052</b>	rectang. box 3 wiring accessories inter. 83.5 mm	500/500
<b>00 053</b>	rectang. box 4 wiring accessories inter. 108 mm	150/150
<b>1SL0064A00</b>	rectang. box 6 wiring accessories inter. 100 mm	1/200

### Box for telephone jack



Code	Description	Box/pack No items
<b>00 054 (*)</b>	box for telephone jacks	189/189

(\*) Complete with lid.

### Junction boxes

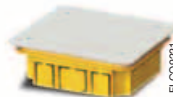

Code	Dimensions (mm) WxHxD	Box/pack No items
<b>00 070</b>	92x92x45	1/105
<b>00 071</b>	120x100x50	1/72
<b>00 072</b>	120x100x70	1/48
<b>00 073</b>	152x100x70	1/42
<b>00 074</b>	160x130x70	1/32

Code	Dimensions (mm) WxHxD	Box/pack No items
<b>00 075</b>	196x152x70	1/19
<b>00 076</b>	294x152x70	1/15
<b>00 077</b>	392x152x70	1/11
<b>00 078</b>	480x160x70	1/10

The separator code 00 090 can be inserted for all articles.



# Wiring accessories and junction boxes

Accessories for wiring accessories and junction boxes in thermoplastic material

## Spare lids for wiring accessories boxes



FLC09218



FLC09219

Code	Description	Box/pack No items
<b>00 055</b>	lid with clips for Ø 65 mm box	25/250
<b>00 056</b>	lid with clips for Ø 85 mm box	20/160

Code	Description	Box/pack No items
<b>00 059</b>	rectangular lid for box inter. 83.5 mm	20/300

## Spare covers for junction boxes

## Separator for junction boxes

7



FLC09272



FLC09271

Code	For boxes type	Box/pack No items
<b>00 091</b>	00 070	20/200
<b>00 092</b>	00 071 – 00 072	20/160
<b>00 093</b>	00 073	10/100
<b>00 094</b>	00 074	10/80
<b>00 095</b>	00 075	10/40
<b>00 096</b>	00 076	10/40
<b>00 097</b>	00 077	10/40
<b>00 098</b>	00 078	10/40

Code	Box/pack No items
<b>00 090</b>	100/400

All codes complete with self-tapping screws.





## Index

Metal rails .....	8/2
Cable-ties and spirals.....	8/4
Polyamide wall plugs.....	8/8
Steel wall plugs .....	8/9
Fastening elements .....	8/10

# Installation material

## Metal rails

### Technical characteristics

- made from cold-rolled steel strips
- electric zinc plated with subsequent trivalent passivation with minimum zinc thickness (6/8 microns) in accordance with new RoHS Standards
- axial dimples on the rails without holes, to facilitate the drilling of installation holes
- strict control of the dimensions as required by the Standard EN 60715
- application area: industrial

#### Top hat section rail

TH 35 - 7.5



Code	Dimensions (mm) BxbxHxS (*)	Length (m)	Box/pack (m)
<b>12 839</b>	35x27x7.5x1	2	20/40

#### Top hat section rail

TH 35 - 15



Code	Dimensions (mm) BxbxHxS(*)	Length (m)	Box/pack (m)
<b>12 840</b>	35x27x15x1.5	2	2/20

#### "G" section rail

G 32



Code	Dimensions (mm) BxbxHxS(*)	Length (m)	Box/pack (m)
<b>12 841</b>	32x16.5x15x1.5	2	2/20

#### Top hat section rail

TH 35 - 7.5 with holes



Code	Dimensions (mm) BxbxHxS(*)	Length (m)	Box/pack (m)
<b>12 849</b>	35x27x7.5x1	2	2/40

#### Top hat section rail

TH 35 - 15 with holes



Code	Dimensions (mm) BxbxHxS(*)	Length (m)	Box/pack (m)
<b>12 850</b>	35x27x15x1.5	2	2/20

#### "G" section rail

G 32 with holes



Code	Dimensions (mm) BxbxHxS(*)	Length (m)	Box/pack (m)
<b>12 853</b>	32x16.5x15x1.5	2	2/20

(\*) B = external base; b = internal base; H = height of rail; S = thickness of rail.

# Installation material

## Accessories for metal rails

### Supporting bracket for metal rails



Code	Box/pack No items
<b>12 892</b>	50/300

### Plastic base for wiring ducts



Code	Box/pack No items
<b>05 210</b>	100/200

### Universal plastic connector



Code	Box/pack No items
<b>12 893</b>	50/3000

### Universal metal connector



12 829



12 828

Code	Box/pack No items
<b>12 828</b>	50/1500
<b>12 829</b>	50/1500

# Installation material

## Cable-ties and spirals

### Technical characteristics

#### Polyamide cable-ties 6/6

- available in two versions:
  - transparent
  - carbon black, UV resistant
- operating temperature from -40 °C to +85 °C
- mounting temperature: from -10 °C to +60 °C
- maximum admissible point +110 °C (for short periods)
- melting temperature +256 °C
- oxygen limit index (LOI) 27%
- absorption of humidity 2.7% (23 °C – 50% R.H.)
- self-extinguishing class according to UL 94: V2
- dielectric rigidity 50,000 V/mm
- strong resistance to bases, greases, hydrocarbons, acetone and chlorates
- not resistant to phenolic and formic acids
- limited resistance to concentrated acids
- according to EN 50146 Standard
- tightening is easy without tearing thanks to the special pitch of the indentations
- the side edges have anti-scratching protection so as not to damage the hands of the operator and not to nick the cable insulation
- rounded point to ease insertion in the countersunk head
- available in boxes of 100 to 1000 items
- particularly suited to the cabling of control panels
- type approval Italian Naval Register ELE/256607/CS
- application area: tertiary/industrial

#### Polyamide cable-ties

- available in black, UV resistant
- operating temperature from -45 °C to +85 °C
- mounting temperature: from -10 °C to +60 °C
- maximum admissible point +110 °C (for short periods)
- melting temperature +256 °C
- oxygen limit index (LOI) 27%
- absorption of humidity <1% (23 °C – 50% R.H.)
- made in UV resistant material
- self-extinguishing class according to UL 94: HB
- strong resistance to bases, greases, hydrocarbons, acetone and chlorates
- not resistant to phenolic and formic acids
- limited resistance to concentrated acids
- high resistance to tearing thanks to the special tightening mechanism
- the side edges have anti-scratching protection so as not to damage the hands of the operator and not to nick the cable insulation
- available in boxes of 100 items
- particularly suited to external use
- application area: tertiary/industrial

#### Spirals

- available in two versions:
  - transparent polyethylene
  - self-extinguishing polyethylene
- suitable for forming bundles of cables and for making cabling look neat and tidy
- they mechanically protect the conductors allowing them to exit from any point through the coils
- application area: tertiary/industrial

8

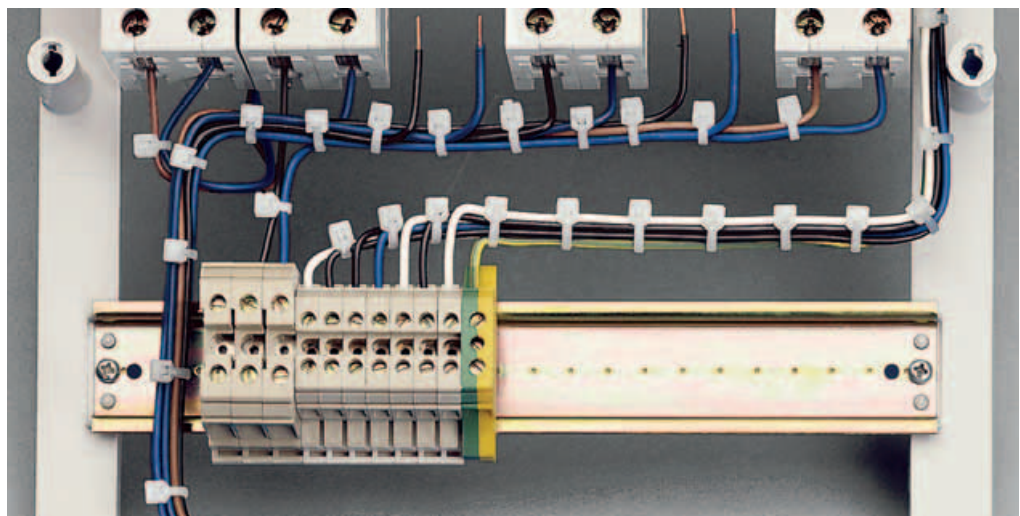

FLM8012



# Installation material

## Cable-ties and spirals

### 6/6 transparent polyamide cable-ties



Code	Dimensions (mm) WxL	Resistance to tensile strength (N) <sup>(*)</sup>	Ø tightening min.(mm) max.(mm)	No items	Box/pack
<b>18 010</b>	98X2.5	80	1 21	100	1/80
<b>18 011</b>	135X2.5	80	1 32	100	1/60
<b>18 013</b>	160X2.6	80	1 40	100	1/50
<b>18 012</b>	140X3.6	130	2 35	100	1/50
<b>18 014</b>	200X3.6	130	2 50	100	1/40
<b>18 017</b>	290X3.6	130	2 80	100	1/30
<b>18 015</b>	178X4.8	220	2 45	100	1/30
<b>18 018</b>	290X4.8	220	3.5 79	100	1/25
<b>18 020</b>	360X4.8	220	3.5 103	100	1/15
<b>18 024</b>	240X7.8	540	3.5 63	100	1/20
<b>18 026</b>	300X7.8	540	4 80	100	1/10
<b>18 028</b>	365x7.8	533	5 102	100	1/20
<b>18 034</b>	450X7.8	540	35 130	100	1/20
<b>18 036</b>	540X7.8	540	35 158	100	1/20
<b>18 038</b>	780X9	700	32 233	100	1/8

<sup>(\*)</sup> N = Newton

### Polyamide cable-ties for external use



Code	Dimensions (mm) WxL	Resistance to tensile strength (N) <sup>(*)</sup>	Ø tightening min.(mm) max.(mm)	No items	Box/pack
<b>18 210</b>	115X6	280	5 25	100	1/30
<b>18 212</b>	180X6	280	9 45	100	1/20
<b>18 218</b>	132X9	390	8 27	100	1/20
<b>18 220</b>	180X9	390	10 40	100	1/20
<b>18 222</b>	260X9	540	26 62	100	1/10
<b>18 224</b>	360X9	540	26 93	100	1/8

<sup>(\*)</sup> N = Newton

### 6/6 black polyamide cable-ties



Code	Dimensions (mm) WxL	Resistance to tensile strength (N) <sup>(*)</sup>	Ø tightening min.(mm) max.(mm)	No items	Box/pack
<b>18 110</b>	98X2.5	80	1 21	100	1/80
<b>18 111</b>	135X2.5	80	1 32	100	1/60
<b>18 113</b>	160X2.6	80	1 40	100	1/50
<b>18 112</b>	140X3.6	130	2 35	100	1/50
<b>18 114</b>	200X3.6	130	2 50	100	1/40
<b>18 117</b>	290X3.6	130	2 80	100	1/30
<b>18 115</b>	178X4.8	220	2 45	100	1/30
<b>18 118</b>	290X4.8	220	3.5 79	100	1/25
<b>18 120</b>	360X4.8	220	3.5 103	100	1/15
<b>18 124</b>	240X7.8	540	3.5 63	100	1/20
<b>18 126</b>	300X7.8	540	4 80	100	1/10
<b>18 128</b>	365X7.8	540	8 100	100	1/20
<b>18 134</b>	450X7.8	540	35 130	100	1/20
<b>18 136</b>	540X7.8	540	35 158	100	1/20
<b>18 138</b>	780X9	700	32 233	100	1/8

<sup>(\*)</sup> N = Newton

### Spirals



Code	Dimensions (mm) <sup>(*)</sup> Ø x a	Resistance to tensile strength (N) <sup>(*)</sup>	For bundle of cables Ø min. (mm) max. (mm)	No items	Box/pack
<b>In transparent polyethylene</b>					
<b>18 370</b>	3x5	2	12	25	1/10
<b>18 372</b>	6x8	5	56	25	1/12
<b>18 374</b>	10x11	12	100	25	1/4
<b>18 376</b>	12x13	14	130	25	1/4
<b>In self-extinguishing polyethylene</b>					
<b>18 380</b>	3x5	2	12	50	1/10
<b>18 382</b>	6x8	5	56	50	1/12
<b>18 384</b>	10x11	12	100	50	1/4
<b>18 386</b>	12x13	14	130	50	1/4

<sup>(\*)</sup> Ø = diameter  
a = width of spiral

# Installation material

## Accessories for cable-ties

### Self-adhesive supports for cable-ties



Code	Description	No items	Box/pack
<b>18 250</b>	transparent plate	50	1/30
<b>18 251</b>	black plate	50	1/30

For cable-ties 2.4-4.8 mm wide.  
 Made in 6/6 transparent or black polyamide.  
 Fast to mount due to its self-adhesive snap on base or it can be fixed with a central Ø 4 mm screw.

### Screw supports for cable-ties



Code	Description	No items	Box/pack
<b>18 252</b>	transparent plate	100	1/60
<b>18 253</b>	black plate	100	1/60

For cable-ties 2.4-4.8 mm wide.  
 Made in 6/6 transparent or black polyamide.  
 Fix with Ø 4 mm screw or Ø 2 mm.

### Pincer for cable-ties



Code	Box/pack No items
<b>18 270</b>	1/10

For tightening and cutting cable-ties 2.4-4.8 mm wide.  
 Made in thermoplastic, shock proof material with internal steel mechanism.  
 Tightening tension can be adjusted by a special nut above the handle.

### Screw supports for external cable-ties



Code	Description	No items	Box/pack
<b>18 280</b>	black plate	25	1/60

For cable-ties 6-9 mm wide.  
 Made in 6/6 black polyamide.  
 Fix with screw wall-plug max Ø 8 mm or with a nail.

# Installation material

## Accessories for cable-ties

### Pivot support for external cable-ties



Code	Description	No items	Box/pack
<b>18 282</b>	black plate	25	1/60

For cable-ties 6-9 mm wide.  
Made in 6/6 black polyamide.

### Pincer for external cable-ties



Code	Box/pack
	No items
<b>18 290</b>	10/30

For tightening and cutting cable-ties 6-9 mm wide.  
Made in painted metal.

# Installation material

## Polyamide wall plugs

### Technical characteristics

- wall-plugs made in 6/6 polyamide
- available in RAL 7035 grey and RAL 9001 white
- wall plugs with nickel-plated steel Allen screws
- resistant to atmospheric agents, gas and ageing
- don't change in temperatures ranging from -30 °C and +90 °C
- suitable for use with various materials (from cement to wood) with a high holding level

Technical details .....page 9/1

Overall dimensions .....page 10/44

### Wall plugs



### Wall plugs with screws



Code	Colour	Dimensions (mm) diam.x L	No items	Box/pack
<b>18 405</b>	grey	5x25	200	1/60
<b>18 406</b>	grey	6x30	100	1/60
<b>18 408</b>	grey	8x40	100	1/30
<b>18 410</b>	grey	10x50	50	1/30

Code	Colour	Dimensions (mm) wall plug diam.	screws diam. x L	No items	Box/pack
<b>18 415</b>	grey	5	3.5 x 25	100	1/30
<b>18 416</b>	grey	6	4 x 30	100	1/30
<b>18 418</b>	grey	8	5 x 40	50	1/30
<b>18 420</b>	grey	10	6 x 50	50	1/30

### Wall plugs with nail/screw



### Wall plugs with hooks



Code	Colour	Dimensions (mm) wall plug diam.	screws diam. x L	No items	Box/pack
<b>18 430</b>	white	5	3.5 x 27	100	1/30
<b>18 432</b>	white	6	4 x 35	100	1/30
<b>18 434</b>	white	6	4 x 55	50	1/30
<b>18 436</b>	white	8	5 x 70	50	1/30
<b>18 440</b>	white	8	5 x 72	50	1/30

Code	Colour	Description	No items	Box/pack
<b>18 450</b>	grey	screw M4	50	1/30
<b>18 452</b>	grey	short angled hook M4	50	1/30
<b>18 454</b>	grey	medium angled hook M4	50	1/30
<b>18 456</b>	grey	open angled hook M4	50	1/12
<b>18 458</b>	grey	closed angled hook M4	50	1/12

For quick fixing.  
Expansion with hammering of the nail/screw, can be unscrewed.  
With a neck to hold the element to be fastened.

Hooks nickel-plated steel.  
Thread M4 – hole Ø 9x36 mm.

# Installation material

## Steel wall plugs

### Technical characteristics

- screw anchors made in burnished passivated zinc
- thread M4 – hole Ø 8x42 mm
- thread M5 – hole Ø 10x50 mm
- suitable for use with masonry (in cement, tiles etc.)

Technical details.....page 9/1

Overall dimensions .....page 10/44

### Wall plugs with hooks

With washer



Code	Description	No items	Box/pack
<b>18 460</b>	screw with M4 Philips countersunk head	50	1/30
<b>18 461</b>	screw with M5 Philips countersunk head	50	1/30
<b>18 464</b>	short angled hook M4	50	1/30
<b>18 465</b>	short angled hook M5	25	1/30
<b>18 466</b>	medium angled hook M4	50	1/30
<b>18 467</b>	medium angled hook M5	25	1/30
<b>18 470</b>	hook with open eyelet M4	50	1/30
<b>18 471</b>	open angled hook M5	25	1/30
<b>18 472</b>	hook with closed eyelet M4	50	1/30
<b>18 473</b>	hook with closed eyelet M5	25	1/30

### Wall plugs with hooks

With washer



Code	Description	No items	Box/pack
<b>18 476</b>	flat hook M4	50	1/30
<b>18 477</b>	flat hook M5	25	1/30
<b>18 478</b>	medium angled hook M4	25	1/30
<b>18 479</b>	medium angled hook M5	25	1/30

### Wall anchors

Thread M4 – hole Ø14



Code	Description	No items	Box/pack
<b>18 490</b>	screw with M4 Philips countersunk head	10	1/30
<b>18 492</b>	M4 head	10	1/30
<b>18 494</b>	hook with open eyelet M4	10	1/30
<b>18 496</b>	hook with closed eyelet M4	10	1/30

### Screws with wall plugs



Code	Description	No items	Box/pack
<b>18 486</b>	screw with hexagonal head M6x50	20	1/30
<b>18 487</b>	screw with hexagonal head M8x55	10	1/30
<b>18 488</b>	screw with hexagonal head M10x60	10	1/30
<b>18 489</b>	screw with hexagonal head M10x70	5	1/30

# Installation material

## Fastening elements

### Technical characteristics

In order to simplify and speed up the laying of conduits and cables in any situation, the following products are available:

- thermo-plastic **snap-on** and **collar** conduit holders
- thermo-plastic **U-bolt** conduit holders
- conduit holder guides
- thermo-plastic **strap** holders
- thermo-plastic cable holders
- steel conduit holders

- thermo-plastic and steel **collar** conduit holders
- self-extinguishing **insulated** poly-carbonate **cable-clamps**
- thermo-plastic fastening elements resistant to abnormal heat and fire up to 650 °C (glow wire test) in compliance with the IEC 60695-2-11 Standard
- thermo-plastic fastening elements with operating conditions from -30 °C to +70 °C
- application area: tertiary/residential

Technical details .....page 9/1

Overall dimensions .....page 10/44

### Snap-on conduit holders



Code	Colour	For conduits Ø (mm)	No items	Box/pack
<b>05 700</b>	grey	16	100	1/12
<b>05 701</b>	grey	20	100	1/12
<b>05 702</b>	grey	25	50	1/12
<b>05 703</b>	grey	32	25	1/12
<b>05 704</b>	grey	40	25	1/12

Self-extinguishing thermo-plastic.  
Fixed to the wall using a wall-plug or a suitable guide.

### Collar conduit holders



Code	Colour	For conduits Ø (mm)	No items	Box/pack
<b>05 720</b>	grey	16	100	1/12
<b>05 721</b>	grey	20	50	1/12
<b>05 722</b>	grey	25	50	1/12
<b>05 723</b>	grey	32	25	1/12

Self-extinguishing thermo-plastic.  
Fixed to the wall using a wall-plug or a suitable guide.

### U-bolt conduit holders



Code	Colour	For conduits Ø (mm)	No items	Box/pack
<b>05 694</b>	grey	12–16	50	1/12
<b>05 695</b>	grey	16–25	50	1/12
<b>05 696</b>	grey	25–32	20	1/12
<b>05 697</b>	grey	32–40	15	1/12
<b>05 698</b>	grey	40–50	10	1/12

Self-extinguishing thermo-plastic.  
Fixed to the wall using a wall-plug or a suitable guide.

### Strap holders



Code	Colour	For straps BxH (mm)	No items	Box/pack
<b>05 760</b>	grey	6x3.5	200	1/60
<b>05 761</b>	grey	8x3.5	200	1/60
<b>05 762</b>	grey	11x5	100	1/60
<b>05 763</b>	white	6x3.5	200	1/60
<b>05 764</b>	white	8x3.5	200	1/60
<b>05 765</b>	white	11x5	100	1/60

Self-extinguishing thermo-plastic.



# Installation material

## Fastening elements

### Conduit clamps



Code	For conduits Ø (mm)	No items	Box/pack
<b>05 730</b>	10	100	1/30
<b>05 731</b>	12	100	1/30
<b>05 732</b>	13	100	1/30
<b>05 733</b>	14	100	1/30
<b>05 734</b>	16	50	1/30
<b>05 735</b>	19–20	50	1/30
<b>05 736</b>	22	50	1/30
<b>05 737</b>	25–26	50	1/12
<b>05 738</b>	32	50	1/12
<b>05 739</b>	38	25	1/12
<b>05 740</b>	40	25	1/12
<b>05 741</b>	50	25	1/12

In galvanised steel.

### Conduit clamp collars



Code	For conduits Ø (mm)	No items	Box/pack
<b>05 745</b>	10	50	1/30
<b>05 746</b>	12	50	1/30
<b>05 747</b>	13	50	1/30
<b>05 748</b>	14	50	1/30
<b>05 749</b>	16	50	1/30
<b>05 750</b>	19–20	25	1/30
<b>05 751</b>	22	25	1/30
<b>05 752</b>	25–26	25	1/30
<b>05 753</b>	32	25	1/12
<b>05 754</b>	38	25	1/12
<b>05 755</b>	40	25	1/12
<b>05 756</b>	50	25	1/12

In galvanised steel.

### Rail for conduit-clamps



Code	Box/pack
<b>05 727</b>	1/1

Self-extinguishing thermo-plastic.  
Supplied in sections of 400 pieces from 200 mm.

### Cable holders



Code	Colour	For conduits and cables Ø (mm)	No items	Box/pack
<b>05 770</b>	grey	4	200	1/60
<b>05 771</b>	grey	5	200	1/60
<b>05 772</b>	grey	6	200	1/60
<b>05 773</b>	grey	7	100	1/60
<b>05 774</b>	grey	8	100	1/60
<b>05 775</b>	grey	9	100	1/30
<b>05 776</b>	grey	10	100	1/30
<b>05 777</b>	grey	12	100	1/30
<b>05 778</b>	grey	13	100	1/30
<b>05 779</b>	grey	14	100	1/30
<b>05 780</b>	grey	16	50	1/30
<b>05 781</b>	grey	19–20	25	1/30
<b>05 782</b>	grey	22	25	1/30
<b>05 783</b>	grey	25–26	25	1/12
<b>05 784</b>	grey	32	25	1/12
<b>05 788</b>	white	4	200	1/60
<b>05 789</b>	white	5	200	1/60
<b>05 790</b>	white	6	200	1/60
<b>05 791</b>	white	7	100	1/60
<b>05 792</b>	white	8	100	1/60
<b>05 793</b>	white	9	100	1/60
<b>05 794</b>	white	10	100	1/30
<b>05 795</b>	white	12	100	1/30
<b>05 796</b>	white	13	100	1/30

Self-extinguishing thermo-plastic.

### Insulated cable-clamps



Code	Clamping capacity (mm²)	No items	Box/pack
<b>05 950</b>	4	100	1/30
<b>05 951</b>	10	50	1/30
<b>05 952</b>	16	25	1/30

Self-extinguishing poly-carbonate.  
Operating temperature from -30 °C to +85 °C.  
Brass clamps.





## Further technical information and applications

### Index

Definition of IP protection degree, IK degree of mechanical shock protection, double insulation and self-extinguishing protection degree .....	9/2
Consumer units for modular circuit breakers – summarised technical data .....	9/4
Switchboards and boxes – reaction to chemical agents .....	9/11
Possible configurations of terminal holders – terminal bars for consumer units .....	9/12
Enclosures and boxes for light prefabrication .....	9/15
Mounting examples and functional details .....	9/16
Branch connections using the bi-material flange .....	9/22

# Further technical information and applications

Definition of IP protection degree, IK degree of mechanical shock protection, double insulation and self-extinguishing protection degree

## IP protection degree for enclosures\*

First number: protection against the penetration of solid bodies

Second number: protection against the penetration of water

### IP Full description

**0** No protection is provided

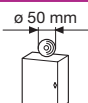
**1**  It must be impossible for a large surface area, for example, the hand, to penetrate (voluntary protection is not provided, however) or solid bodies larger than 50 mm in diameter

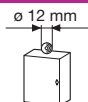
**2**  It must be impossible for fingers or similar objects with a maximum length of 80 mm or solid bodies with a diameter greater than 12 mm, to penetrate

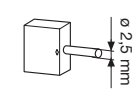
**3**  It must be impossible for tools, wires, etc. with a diameter or thickness greater than 2.5 mm or solid bodies with a diameter greater than 2.5 mm, to penetrate

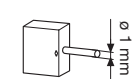
**4**  It must not be possible for wires or plates with a thickness greater than 1.0 mm or solid bodies with a diameter greater than 1.0, to penetrate

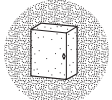
**5**  Not totally dust proof, but the quantity that penetrates is not such to prevent the material from functioning well

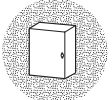
**6**  No dust can penetrate

1<sup>st</sup> number defined by Standards CEI 70-1 - IEC 60529

### IP Full description

**0** No protection is provided

**1**  Vertically-falling drops of water must not cause damage

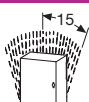
**2**  Vertically-falling drops of water will not cause damage when angled at a maximum of 15° from vertical

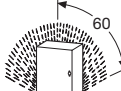
**3**  Rain water falling from a direction creating a maximum angle of 60° from vertical must not cause damage

**4**  Water sprayed onto the covering from any direction must not cause damage

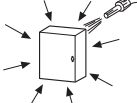
**5**  Water projected with a nozzle from all directions must not cause damage

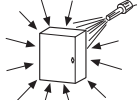
**6**  In the case of waves or powerful water jets must not penetrate the covering in harmful quantities

**7**  Harmful quantities of water must not penetrate inside the immersed covering in specific conditions of pressure or duration

**8** The material is suitable to remain constantly immersed in water in the conditions specified by the manufacturer

2<sup>nd</sup> number defined by Standards CEI 70-1 - IEC 60529

### \* Consumer unit with IP 40 protection degree

In a consumer unit, protection degree IP 40 (it is impossible to introduce a wire with a diameter of 1 mm) is obtained by installing equipment with protection degree IP 40 and by using the relative accessories (module-covers).

## Double insulation

 This symbol shown on the consumer units/switchboards/boxes/enclosures indicates that they have been constructed so that they will provide protection against indirect contacts by means of complete insulation. To this end they must be installed correctly, following the instructions that accompany the product and using the accessories supplied (screw covering caps).

# Further technical information and applications

Definition of IP protection degree, IK degree of mechanical shock protection, double insulation and self-extinguishing protection degree

## Degree of mechanical shock protection IK conforming to the CEI EN 62262 Standard

Code IK	Shock energy (Joule)
00	not protected
01	0.15 Joule
02	0.2 Joule
03	0.35 Joule
04	0.5 Joule
05	0.7 Joule
06	1 Joule
07	2 Joule
08	5 Joule
09	10 Joule
10	20 Joule

Text equipment used includes a spring hammer, a pendulum hammer and a vertical hammer.

## Self-extinguishing protection degree

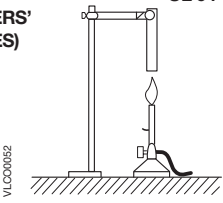
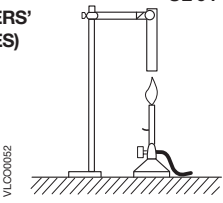
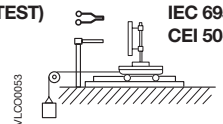
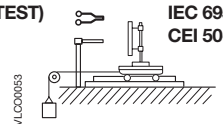
Test text	Equipment required	Compliance with Standards	Purpose of the test	Test results	Heat source	Test conditions	Characteristic elements
<b>UL (UNDERWRITERS' LABORATORIES)</b> 		<b>UL 94</b>	A classification is given to the various types of behaviour that the materials may have following contact with the Bunsen flame	V0 if the test specimen burns for less than 5 seconds before going out V1 if it burns for less than 25 seconds V2 if it burns for less than 25 seconds, dripping glowing material HB if it burns for more than 25 seconds (horizontal test specimen with a maximum burning speed of 38 mm per minute) Can be assimilated with ASTM D-635	Bunsen burner flame 10 sec	Flame applied for 10 seconds and for two consecutive times	Duration of combustion
<b>(GLOW-WIRE TEST)</b> 		<b>IEC 695-2-1 CEI 50-11</b>	Simulates the types of thermal stress that may be produced by the sources of heat or ignition (glowing elements or overcharged resistors for short periods) in order to assess the danger of fire using this simulation	Any manifestation of a flame must stop within 30 seconds of removing the glow-wire <b>TEST TEMPERATURES</b> 650 °C 750 °C 850 °C 960 °C	Glow-wire 4 mm in diameter	Wire applied for 30 seconds	Time it takes the flame to extinguish

# Further technical information and applications

## Consumer units for modular circuit breakers – summarised technical data

### Flush-mounting consumer units IP 40 Unibox Series

CODE	1SL0500A00 <sup>(1)</sup> 1SL0510A00 <sup>(2)</sup>	1SL0501A00 <sup>(1)</sup> 1SL0511A00 <sup>(2)</sup>	1SL0502A00 <sup>(1)</sup> 1SL0512A00 <sup>(2)</sup>	1SL0503A00 <sup>(1)</sup> 1SL0513A00 <sup>(2)</sup>	1SL0504A00 <sup>(1)</sup> 1SL0514A00 <sup>(2)</sup>
NUMBER OF MODULES	8	12	24	36	54
COLOUR	RAL 9016 white	RAL 9016 white	RAL 9016 white	RAL 9016 white	RAL 9016 white
DOUBLE INSULATION	YES	YES	YES	YES	YES
RESISTANCE TO HEAT	GWT 650 °C	GWT 650 °C	GWT 650 °C	GWT 65 °C	GWT 650 °C
TYPE OF MATERIAL	Thermo-plastic	Thermo-plastic	Thermo-plastic	Thermo-plastic	Thermo-plastic
SHOCK RESISTANCE	10 Joule	10 Joule	10 Joule	10 Joule	10 Joule
INSTALLATION TEMPERATURE	-15 °C ÷ +60 °C	-15 °C ÷ +60 °C	-15 °C ÷ +60 °C	-15 °C ÷ +60 °C	-15 °C ÷ +60 °C
RESISTANCE TO HEAT	up to +85 °C	up to +85 °C	up to +85 °C	up to +85 °C	up to +85 °C
PROTECTION DEGREE	IP 40	IP 40	IP 40	IP 40	IP 40
MAX DISSIPATION POWER <sup>(3)</sup>	22 W	29 W	35 W	50 W	58 W
EXTRACTABLE FRAME	YES	YES	YES	YES	YES

(1) With opaque door.

(2) With transparent door.

(3) Data concerning dissipation power have been obtained by following the instructions of CEI 23-49 Standard, with a temperature difference of Dt = 30 °C.

### Reaction to chemical agents (\*)

Chemical agent	Reaction
Cold water	resistant
Hot water	resistant
Sulphuric acid 40%	partially resistant
Hydrochloric acid 35%	partially resistant
Acetic acid 10%	resistant
Benzole	not resistant
Gasoline	resistant
Acetone	not resistant
Ethyl alcohol	partially resistant
Ammonia liquid	resistant
Dichloromethane	not resistant
Diesel oil- naphtha	resistant
Mineral oils and grasses	resistant
Food oils and grasses	resistant
Perchloroethylene	not resistant
Trichloroethylene	not resistant
Ethylether	resistant
Ozone	resistant
Toluene	not resistant
Methanol	partially resistant
Spirits	resistant
Milk	resistant
Fruit juices	resistant
Fluoride hydrocarbons	not resistant
Lye-washes	resistant
Cleansings	resistant
Water solution	resistant

IP 40 Estetica and Europa Series flush-mounting consumer units

■ resistant ▲ partially resistant ● not resistant

V.LC00054



## Further technical information and applications

### Consumer units for modular circuit breakers – summarised technical data

#### Flush-mounting consumer units IP 40 Estetica Series with door and Europa Series consumer units

CODE	1SL2024A00 - 12 037	1SL2028A00 - 12 038 1SL2040A00 - 12 026 1SL2057A00 - 12 058	1SL2032A00 - 12 042 1SL2004A00 - 12 027 1SL2061A00 - 12 062	1SL2033A00 - 12 043	1SL2034A00 - 12 044 1SL2045A00 - 12 030 1SL2063A00 - 12 064	1SL2036A00 - 12 046 1SL2048A00 - 12 031 1SL2065A00 - 12 066	1SL2052A00 - 12 035 1SL2067A00 - 12 068
NUMBER OF MODULES	4	8	12	18	24	36	54
COLOUR	RAL 9016 white RAL 7021 grey	RAL 9016 white RAL 7021 grey	RAL 9016 white RAL 7021 grey	RAL 9016 white RAL 7021 grey	RAL 9016 white RAL 7021 grey	RAL 9016 white RAL 7021 grey	RAL 9016 white
WITH TRANSPARENT DOOR	YES	YES	YES	YES	YES	YES	YES
WITH OPAQUE DOOR	-	YES	YES	-	YES	YES	YES
DOUBLE INSULATION	YES	YES	YES	YES	YES	YES	YES
RESISTANCE TO HEAT	GWT 650 °C	GWT 650 °C	GWT 650 °C	GWT 650 °C	GWT 650 °C	GWT 650 °C	GWT 650 °C
TYPE OF MATERIAL	Thermo-plastic	Thermo-plastic	Thermo-plastic	Thermo-plastic	Thermo-plastic	Thermo-plastic	Thermo-plastic
SHOCK RESISTANCE	6 Joule	6 Joule	6 Joule	6 Joule	6 Joule	6 Joule	6 Joule
INSTALLATION							
TEMPERATURE	-15 °C ÷ +60 °C	-15 °C ÷ +60 °C	-15 °C ÷ +60 °C	-15 °C ÷ +60 °C	-15 °C ÷ +60 °C	-15 °C ÷ +60 °C	-15 °C ÷ +60 °C
RESISTANCE TO HEAT	up to +85 °C	up to +85 °C	up to +85 °C	up to +85 °C	up to +85 °C	up to +85 °C	up to +85 °C
PROTECTION DEGREE	IP 40	IP 40	IP 40	IP 40	IP 40	IP 40	IP 40
MAX DISSIPATION							
POWER <sup>(1)</sup>	19 W	25 W	29 W	40 W	45 W	68 W	85 W
EXTRACTABLE FRAME	-	YES	YES	YES	YES	YES	YES

(1) Data concerning dissipative power have been obtained by following the instructions in CEI 23-49 Standard, with a temperature difference of  $Dt = 30\text{ °C}$ .

# Further technical information and applications

## Consumer units for modular circuit breakers – summarised technical data

### Wall-mounting consumer units IP 40 Unibox Series without door

CODE	12 208	12 212	12 214	12 216	12 217
NUMBER OF MODULES <sup>(1)</sup>	8 + 1	12 + 1	24 + 2	36 + 3	54 + 3
COLOUR	RAL 9016 white	RAL 9016 white	RAL 9016 white	RAL 9016 white	RAL 9016 white
WITHOUT DOOR	YES	YES	YES	YES	YES
DOUBLE INSULATION	YES	YES	YES	YES	YES
RESISTANCE TO HEAT	GWT 650 °C	GWT 650 °C	GWT 650 °C	GWT 650 °C	GWT 650 °C
TYPE OF MATERIAL	Thermo-plastic	Thermo-plastic	Thermo-plastic	Thermo-plastic	Thermo-plastic
SHOCK RESISTANCE	10 Joule (IK 09)	10 Joule (IK 09)	10 Joule (IK 09)	10 Joule (IK 09)	10 Joule (IK 09)
INSTALLATION TEMPERATURE	-25 °C ÷ +60 °C	-25 °C ÷ +60 °C	-25 °C ÷ +60 °C	-25 °C ÷ +60 °C	-25 °C ÷ +60 °C
RESISTANCE TO HEAT	up to +85 °C	up to +85 °C	up to +85 °C	up to +85 °C	up to +85 °C
PROTECTION DEGREE	IP 40	IP 40	IP 40	IP 40	IP 40
MAX DISSIPATION POWER <sup>(2)</sup>	22 W	34 W	58 W	70 W	83 W
CABLE HOLDING SYSTEM	YES	YES	YES	YES	YES
DESIGNED FOR INPUT	CONDUITS Ø 25÷32 mm TRUNKINGS up to 200X60 mm	CONDUITS Ø 25÷32 mm TRUNKINGS up to 200X60 mm	CONDUITS Ø 25÷32 mm TRUNKINGS up to 200X60 mm	CONDUITS Ø 25÷32 mm TRUNKINGS up to 200X60 mm	CONDUITS Ø 25÷32 mm TRUNKINGS up to 200X60 mm
EXTRACTABLE FRAME	-	-	YES	YES	YES

(1) Extra modules see characteristics on page 2/23.

(2) Data concerning dissipative power have been obtained by following the instructions in CEI 23-49 Standard, with a temperature difference of Dt = 30 °C.

### Wall-mounting consumer units IP 40 Unibox Series with door

CODE	12 238 12 258	12 242 12 262	12 244 12 264	12 246 12 266	12 247 12 267
NUMBER OF MODULES	8 + 1	12 + 1	24 + 2	36 + 3	54 + 3
COLOUR	RAL 9016 white	RAL 9016 white	RAL 9016 white	RAL 9016 white	RAL 9016 white
WITHOUT DOOR	-	-	-	-	-
WITH TRANSPARENT DOOR	YES	YES	YES	YES	YES
WITH OPAQUE DOOR	YES	YES	YES	YES	YES
DOUBLE INSULATION	YES	YES	YES	YES	YES
RESISTANCE TO HEAT	GWT 650 °C	GWT 650 °C	GWT 650 °C	GWT 650 °C	GWT 650 °C
TYPE OF MATERIAL	Thermo-plastic	Thermo-plastic	Thermo-plastic	Thermo-plastic	Thermo-plastic
SHOCK RESISTANCE	10 Joule (IK 09)	10 Joule (IK 09)	10 Joule (IK 09)	10 Joule (IK 09)	10 Joule (IK 09)
INSTALLATION TEMPERATURE	-25 °C ÷ +60 °C	-25 °C ÷ +60 °C	-25 °C ÷ +60 °C	-25 °C ÷ +60 °C	-25 °C ÷ +60 °C
RESISTANCE TO HEAT	up to +85 °C	up to +85 °C	up to +85 °C	up to +85 °C	up to +85 °C
PROTECTION DEGREE	IP 40	IP 40	IP 40	IP 40	IP 40
MAX DISSIPATION POWER <sup>(1)</sup>	20 W	30 W	40 W	45 W	54 W
CABLE HOLDING SYSTEM	YES	YES	YES	YES	YES
DESIGNED FOR INPUT	CONDUITS Ø 25÷32 mm TRUNKINGS up to 200X60 mm	CONDUITS Ø 25÷32 mm TRUNKINGS up to 200X60 mm	CONDUITS Ø 25÷32 mm TRUNKINGS up to 200X60 mm	CONDUITS Ø 25÷32 mm TRUNKINGS up to 200X60 mm	CONDUITS Ø 25÷32 mm TRUNKINGS up to 200X60 mm
EXTRACTABLE FRAME	-	-	YES	YES	YES

(1) Extra modules see characteristics on page 2/23.

(2) Data concerning dissipative power have been obtained by following the instructions in CEI 23-49 Standard, with a temperature difference of Dt = 30 °C.

### Reaction to chemical agents (\*)

Chemical Agent	Reaction
Cold water	resistant
Hot water	resistant
Sulphuric acid 40%	partially resistant
Hydrochloric acid 35%	partially resistant
Acetic acid 10%	resistant
Benzole	resistant
Gasoline	resistant
Acetone	resistant
Ethyl alcohol	resistant
Ammonia liquid	resistant
Dichloromethane	resistant
Diesel oil- naphtha	resistant
Mineral oils and grases	resistant
Food oils and grases	resistant
Perchloroethylene	resistant
Trichloroethylene	resistant
Ethylether	resistant
Ozone	resistant
Toluene	resistant
Methanol	resistant
Spirits	resistant
Milk	resistant
Fruit juices	resistant
Fluoride hydrocarbons	resistant
Lye-washes	resistant
Cleansings	resistant
Water solution	resistant

IP 40 Unibox and Europa Series wall-mounting consumer units and IP 40 wall-mounting covers

■ resistant ▲ partially resistant ● not resistant

VLC00055

(\*) Indications concerning the resistance of the products to chemical agents must be considered as an indication only, and refer to standard conditions (40 °C, integral product).

# Further technical information and applications

## Consumer units for modular circuit breakers – summarised technical data

### Covers and wall-mounting consumer units IP 40 Europa Series without door

CODE	1SL2402A00 12 422	1SL2404A00 12 424	1SL2406A00 12 426	1SL2408A00 12 428	1SL2412A00 12 432	1SL2414A00 12 434	1SL2416A00 12 436	1SL2417A00 12 437
NUMBER OF MODULES	2	4	6	8	12	24	36	54
COLOUR	RAL 9016 white RAL 7035 grey	RAL 9016 white RAL 7035 grey	RAL 9016 white RAL 7035 grey	RAL 9016 white RAL 7035 grey	RAL 9016 white RAL 7035 grey	RAL 9016 white RAL 7035 grey	RAL 9016 white RAL 7035 grey	RAL 9016 white RAL 7035 grey
WITHOUT DOOR	YES	YES	YES	YES	YES	YES	YES	YES
DOUBLE INSULATION	YES	YES	YES	YES	YES	YES	YES	YES
RESISTANCE TO HEAT	GWT 650 °C	GWT 650 °C	GWT 650 °C	GWT 650 °C	GWT 650 °C	GWT 650 °C	GWT 650 °C	GWT 650 °C
TYPE OF MATERIAL	Thermo-plastic	Thermo-plastic	Thermo-plastic	Thermo-plastic	Thermo-plastic	Thermo-plastic	Thermo-plastic	Thermo-plastic
SHOCK RESISTANCE	6 Joule	6 Joule	6 Joule	6 Joule	6 Joule	6 Joule	6 Joule	6 Joule
INSTALLATION TEMPERATURE	-25 °C ÷ +60 °C	-25 °C ÷ +60 °C	-25 °C ÷ +60 °C	-25 °C ÷ +60 °C	-25 °C ÷ +60 °C	-25 °C ÷ +60 °C	-25 °C ÷ +60 °C	-25 °C ÷ +60 °C
RESISTANCE TO HEAT	up to +85 °C	up to +85 °C	up to +85 °C	up to +85 °C	up to +85 °C	up to +85 °C	up to +85 °C	up to +85 °C
PROTECTION DEGREE	IP 40	IP 40	IP 40	IP 40	IP 40	IP 40	IP 40	IP 40
MAX DISSIPATION POWER <sup>(1)</sup>	10 W	14 W	16 W	22 W	28 W	50 W	72 W	96 W
DESIGNED FOR INPUT	-	-	-	CONDUITS Ø 25÷32 mm	CONDUITS Ø 25÷32 mm	CONDUITS Ø 25÷32 mm	CONDUITS Ø 25÷32 mm	Direct branch connection CONDUITS-cables Ø 5÷35 mm
DESIGNED FOR MOULDED-CASE CIRCUIT BREAKERS	-	-	-	-	-	-	YES	YES
DESIGNED FOR RAPID CABLING	-	-	-	-	-	-	-	UNIFIX L

(1) Data concerning dissipative power have been obtained by following the instructions in CEI 23-49 Standard, with a temperature difference of Dt = 30 °C.

### Wall-mounting consumer units IP 40 Europa Series with door

CODE	1SL2438A00 – 12 448 12 458 – 12 468	1SL2442A00 – 12 452 12 462 – 12 472	1SL2444A00 – 12 454 12 464 – 12 474	1SL2446A00 – 12 456 12 466 – 12 476	1SL2447A00 – 12 457 12 467 – 12 477
NUMBER OF MODULES	8	12	24	36	54
COLOUR	RAL 9016 white RAL 7035 grey	RAL 9016 white RAL 7035 grey	RAL 9016 white RAL 7035 grey	RAL 9016 white RAL 7035 grey	RAL 9016 white RAL 7035 grey
WITH TRANSPARENT DOOR	YES	YES	YES	YES	YES
WITH OPAQUE DOOR	YES	YES	YES	YES	YES
DOUBLE INSULATION	YES	YES	YES	YES	YES
RESISTANCE TO HEAT	GWT 650 °C	GWT 650 °C	GWT 650 °C	GWT 650 °C	GWT 650 °C
TYPE OF MATERIAL	Thermo-plastic	Thermo-plastic	Thermo-plastic	Thermo-plastic	Thermo-plastic
SHOCK RESISTANCE	6 Joule	6 Joule	6 Joule	6 Joule	6 Joule
INSTALLATION TEMPERATURE	-25 °C ÷ +60 °C	-25 °C ÷ +60 °C	-25 °C ÷ +60 °C	-25 °C ÷ +60 °C	-25 °C ÷ +60 °C
RESISTANCE TO HEAT	up to +85 °C	up to +85 °C	up to +85 °C	up to +85 °C	up to +85 °C
PROTECTION DEGREE	IP 40	IP 40	IP 40	IP 40	IP 40
MAX DISSIPATION POWER <sup>(1)</sup>	19 W	27 W	31 W	45 W	56 W
DESIGNED FOR INPUT	CONDUITS Ø 25÷32 mm	CONDUITS Ø 25÷32 mm	CONDUITS Ø 25÷32 mm	CONDUITS Ø 25÷32 mm	Direct branch connections CONDUITS-cables Ø 5÷35 mm
DESIGNED FOR MOULDED-CASE CIRCUIT BREAKERS	-	-	-	YES	YES
DESIGNED FOR RAPID CABLING	-	-	-	-	UNIFIX L

(1) Data concerning dissipative power have been obtained by following the instructions in CEI 23-49 Standard, with a temperature difference of Dt = 30 °C.

### Reaction to chemical agents (\*)

Chemical agent	Reaction
Cold water	resistant
Hot water	partially resistant
Sulphuric acid 40%	resistant
Hydrochloric acid 35%	resistant
Acetic acid 10%	resistant
Benzole	resistant
Gasoline	resistant
Acetone	resistant
Ethyl alcohol	resistant
Ammonia liquid	resistant
Dichloromethane	resistant
Diesel oil- naphtha	resistant
Mineral oils and grasses	resistant
Food oils and grasses	resistant
Perchloroethylene	resistant
Trichloroethylene	resistant
Ethylether	resistant
Ozone	resistant
Toluene	resistant
Methanol	resistant
Spirits	resistant
Milk	resistant
Fruit juices	resistant
Fluoride hydrocarbons	resistant
Lye-washes	partially resistant
Cleansings	partially resistant
Water solution	resistant

IP 40 Europa Polycarbonate Series wall-mounting consumer units

■ resistant ▲ partially resistant ● not resistant

VLC00065

(\*) Indications concerning the resistance of the products to chemical agents must be considered as an indication only, and refer to standard conditions (40 °C, integral product).

# Further technical information and applications

## Consumer units for modular circuit breakers – summarised technical data

### Wall-mounting consumer units IP 40 Europa Series

CODE	12 702	12 704	12 708	12 712	12 714	12 716	12 718
NUMBER OF MODULES	2	4	8	12	24	36	54
COLOUR	RAL 7035 grey	RAL 7035 grey	RAL 7035 grey	RAL 7035 grey	RAL 7035 grey	RAL 7035 grey	RAL 7035 grey
WITHOUT DOOR	YES	YES	YES	YES	YES	YES	YES
DOUBLE INSULATION	YES	YES	YES	YES	YES	YES	YES
RESISTANCE TO HEAT	GWT 960 °C	GWT 960 °C	GWT 960 °C	GWT 960 °C	GWT 960 °C	GWT 960 °C	GWT 960 °C
TYPE OF MATERIAL	Polycarbonate	Polycarbonate	Polycarbonate	Polycarbonate	Polycarbonate	Polycarbonate	Polycarbonate
SHOCK RESISTANCE	20 Joule (IK 10)	20 Joule (IK 10)	20 Joule (IK 10)	20 Joule (IK 10)	20 Joule (IK 10)	20 Joule (IK 10)	20 Joule (IK 10)
INSTALLATION TEMPERATURE	-25 °C ÷ +60 °C	-25 °C ÷ +60 °C	-25 °C ÷ +60 °C	-25 °C ÷ +60 °C	-25 °C ÷ +60 °C	-25 °C ÷ +60 °C	-25 °C ÷ +60 °C
RESISTANCE TO HEAT	up to +85 °C	up to +85 °C	up to +85 °C	up to +85 °C	up to +85 °C	up to +85 °C	up to +85 °C
PROTECTION DEGREE	IP 40	IP 40	IP 40	IP 40	IP 40	IP 40	IP 40
MAX DISSIPATION POWER <sup>(1)</sup>	15 W	17 W	25 W	40 W	55 W	75 W	96 W
FLANGE FOR DIRECT BRANCH	-	-	COND. AND TRUNK Ø 5÷35 mm	COND. AND TRUNK Ø 5÷35 mm	COND. AND TRUNK Ø 5÷35 mm	COND. AND TRUNK Ø 5÷35 mm	COND. AND TRUNK Ø 5÷35 mm
EXTRACTABLE FRAME	-	YES	YES	YES	YES	YES	YES
DESIGNED FOR MOULDED-CASE							
CIRCUIT BREAKERS	-	YES	YES	YES	YES	YES	YES
DESIGNED FOR							
RAPID CABLING	-	-	UNIFIX L	UNIFIX L	UNIFIX L	UNIFIX L	UNIFIX L

(1) Data concerning dissipative power have been obtained by following the instructions in CEI 23-49 Standard, with a temperature difference of Dt = 30 °C.

### Wall-mounting consumer units IP 55 Europa Series

CODE	12 644	12 646	12 650	12 652	12 654
NUMBER OF MODULES	4	6	10	20	10
COLOUR	RAL 7035 grey	RAL 7035 grey	RAL 7035 grey	RAL 7035 grey	RAL 7035 grey
WITH TRANSPARENT DOOR	YES	YES	YES	YES	YES
DOUBLE INSULATION	YES	YES	YES	YES	YES
RESISTANCE TO HEAT	GWT 650 °C	GWT 650 °C	GWT 650 °C	GWT 650 °C	GWT 650 °C
TYPE OF MATERIAL	Thermo-plastic	Thermo-plastic	Thermo-plastic	Thermo-plastic	Thermo-plastic
SHOCK RESISTANCE	6 Joule	6 Joule	6 Joule	6 Joule	6 Joule
INSTALLATION TEMPERATURE	-25 °C ÷ +60 °C	-25 °C ÷ +60 °C	-25 °C ÷ +60 °C	-25 °C ÷ +60 °C	-25 °C ÷ +60 °C
RESISTANCE TO HEAT	up to +85 °C	up to +85 °C	up to +85 °C	up to +85 °C	up to +85 °C
PROTECTION DEGREE	IP 55	IP 55	IP 55	IP 55	IP 55
MAX DISSIPATION POWER <sup>(1)</sup>	13 W	17 W	20 W	35 W	35 W
DESIGNED FOR INPUT	Ø 16 ÷ 40 mm	Ø 16 ÷ 40 mm	Ø 16 ÷ 40 mm	Ø 16 ÷ 40 mm	Ø 16 ÷ 40 mm

(1) Data concerning dissipative power have been obtained by following the instructions in CEI 23-49 Standard, with a temperature difference of Dt = 30 °C.

### Reaction to chemical agents (\*)

Chemical Agent	Reaction
Cold water	resistant
Hot water	resistant
Sulphuric acid 40%	partially resistant
Hydrochloric acid 35%	partially resistant
Acetic acid 10%	resistant
Benzole	not resistant
Gasoline	not resistant
Acetone	not resistant
Ethyl alcohol	partially resistant
Ammonia liquid	not resistant
Dichloromethane	not resistant
Diesel oil- naphta	not resistant
Mineral oils and grases	not resistant
Food oils and grases	not resistant
Perchloroethylene	not resistant
Trichloroethylene	not resistant
Ethylether	not resistant
Ozone	not resistant
Toluene	not resistant
Methanol	partially resistant
Spirits	not resistant
Milk	not resistant
Fruit juices	not resistant
Fluoride hydrocarbons	not resistant
Lye-washes	not resistant
Cleansings	not resistant
Water solution	not resistant

IP 55 Europa Series wall-mounting consumer units

■ resistant ▲ partially resistant ● not resistant

VLC00057

(\*) Indications concerning the resistance of the products to chemical agents must be considered as an indication only, and refer to standard conditions (40 °C, integral product).

# Further technical information and applications

## Consumer units for modular circuit breakers – summarised technical data

### Wall-mounting consumer units IP 65 Fly Series

CODE	12 722-12 742	12 743	12 745	12 746	12 747
NUMBER OF MODULES	2/4	8	12	24	36
COLOUR	RAL 7035 grey	RAL 7035 grey	RAL 7035 grey	RAL 7035 grey	RAL 7035 grey
WITH TRANSPARENT DOOR	YES	YES	YES	YES	YES
WITH OPAQUE DOOR	YES	-	-	-	-
DOUBLE INSULATION	YES	YES	YES	YES	YES
TYPE OF MATERIAL	Thermo-plastic	Thermo-plastic	Thermo-plastic	Thermo-plastic	Thermo-plastic
SHOCK RESISTANCE	6 Joule (IK 08)	6 Joule (IK 08)	6 Joule (IK 08)	6 Joule (IK 08)	6 Joule (IK 08)
RESISTANCE TO HEAT	up to +85 °C	up to +85 °C	up to +85 °C	up to +85 °C	up to +85 °C
INSTALLATION TEMPERATURE	-25 °C ÷ +60 °C	-25 °C ÷ +60 °C	-25 °C ÷ +60 °C	-25 °C ÷ +60 °C	-25 °C ÷ +60 °C
RESISTANCE TO HEAT	GWT 650 °C	GWT 650 °C	GWT 650 °C	GWT 650 °C	GWT 650 °C
PROTECTION DEGREE	IP 65	IP 65	IP 65	IP 65	IP 65
MAX DISSIPATION POWER <sup>(1)</sup>	11 W	15 W	19 W	31 W	45 W
FLANGE FOR DIRECT BRANCH	-	COND. AND TRUNK Ø 5÷35 mm	COND. AND TRUNK Ø 5÷35 mm	COND. AND TRUNK Ø 5÷35 mm	COND. AND TRUNK Ø 5÷35 mm
EXTRACTABLE FRAME	-	YES	YES	YES	YES
DESIGNED FOR MOULED-CASE					
CIRCUIT BREAKERS	-	YES	YES	YES	YES
DESIGNED FOR RAPID CABLING	-	UNIFIX L	UNIFIX L	UNIFIX L	UNIFIX L

(1) Data concerning dissipative power have been obtained by following the instructions in CEI 23-49 Standard, with a temperature difference of Dt = 30 °C.

### Wall-mounting consumer units IP 65 Europa Series

CODE	12 724 – 12 744	12 728 – 12 748	12 732 – 12 752	12 733 – 12 753	12 734 – 12 754	12 735 – 12 755 12 736 – 12 756	12 738 – 12 758
NUMBER OF MODULES	4	8	12	18	24	36	54
COLOUR	RAL 7035 grey	RAL 7035 grey	RAL 7035 grey	RAL 7035 grey	RAL 7035 grey	RAL 7035 grey	RAL 7035 grey
WITH TRANSPARENT DOOR	YES	YES	YES	YES	YES	YES	YES
WITH OPAQUE DOOR	YES	YES	YES	YES	YES	YES	YES
DOUBLE INSULATION	YES	YES	YES	YES	YES	YES	YES
RESISTANCE TO HEAT	GWT 650 °C	GWT 650 °C	GWT 650 °C	GWT 650 °C	GWT 650 °C	GWT 650 °C	GWT 650 °C
TYPE OF MATERIAL	Thermo-plastic	Thermo-plastic	Thermo-plastic	Thermo-plastic	Thermo-plastic	Thermo-plastic	Thermo-plastic
SHOCK RESISTANCE	6 Joule (IK 08)	6 Joule (IK 08)	6 Joule (IK 08)	6 Joule (IK 08)	6 Joule (IK 08)	6 Joule (IK 08)	6 Joule (IK 08)
INSTALLATION TEMPERATURE	-25 °C ÷ +60 °C	-25 °C ÷ +60 °C	-25 °C ÷ +60 °C	-25 °C ÷ +60 °C	-25 °C ÷ +60 °C	-25 °C ÷ +60 °C	-25 °C ÷ +60 °C
RESISTANCE TO HEAT	up to +85 °C	up to +85 °C	up to +85 °C	up to +85 °C	up to +85 °C	up to +85 °C	up to +85 °C
PROTECTION DEGREE	IP 65	IP 65	IP 65	IP 65	IP 65	IP 65	IP 65
MAX DISSIPATION POWER <sup>(1)</sup>	15 W	20 W	30 W	32 W	34 W	45 W	56 W
FLANGE FOR DIRECT BRANCH	-	COND. AND TRUNK Ø 5÷35 mm	COND. AND TRUNK Ø 5÷35 mm	COND. AND TRUNK Ø 5÷35 mm	COND. AND TRUNK Ø 5÷35 mm	COND. AND TRUNK Ø 5÷35 mm	COND. AND TRUNK Ø 5÷35 mm
EXTRACTABLE MOULED-CASE	YES	YES	YES	YES	YES	YES	YES
DESIGNED FOR MOULED-CASE							
CIRCUIT BREAKERS	YES	YES	YES	YES	YES	YES	YES
DESIGNED FOR RAPID CABLING	-	UNIFIX L	UNIFIX L	UNIFIX L	UNIFIX L	UNIFIX L	UNIFIX L

(1) Data concerning dissipative power have been obtained by following the instructions in CEI 23-49 Standard, with a temperature difference of Dt = 30 °C.

### Reaction to chemical agents (\*)

	Cold water	Hot water	Sulphuric acid 40%	Hydrochloric acid 35%	Acetic acid 10%	Benzole	Gasoline	Acetone	Ethyl alcohol	Ammonia liquid	Dichloromethane	Diesel oil- naphtha	Mineral oils and grases	Food oils and grases	Perchloroethylene	Trichloroethylene	Ethylether	Ozone	Toluene	Methanol	Spirits	Milk	Fruit juices	Fluoride hydrocarbons	Lye-washes	Cleansings	Water solution
IP 65 Fly and Europa Series wall-mounting consumer units	■	■	▲	▲	■	●	■	■	▲	■	●	■	■	■	●	●	●	■	●	▲	■	■	■	●	■	■	■

■ resistant   
 ▲ partially resistant   
 ● not resistant

VULCO0055

(\*) Indications concerning the resistance of the products to chemical agents must be considered as an indication only, and refer to standard conditions (40 °C, integral product).

# Further technical information and applications

## Consumer units for modular circuit breakers – summarised technical data

### IP 65 Marostica Series switchboards for industrial application with blank front

CODE	13 200	13 204	13 205	13 206	13 208
NUMBER OF MODULES	4	12	12	12	18
DIMENSIONS (mm)	136x540x110	275x370x140	275x455x140	275x570x140	380x570x140
COLOUR	RAL 7035 grey	RAL 7035 grey	RAL 7035 grey	RAL 7035 grey	RAL 7035 grey
WITH TRANSPARENT DOOR	YES	YES	YES	YES	YES
DOUBLE INSULATION	YES	YES	YES	YES	YES
RESISTANCE TO HEAT	GWT 960 °C	GWT 960 °C	GWT 960 °C	GWT 960 °C	GWT 960 °C
TYPE OF MATERIAL	Polycarbonate	Polycarbonate	Polycarbonate	Polycarbonate	Polycarbonate
SHOCK RESISTANCE	20 Joule (IK 10)	20 Joule (IK 10)	20 Joule (IK 10)	20 Joule (IK 10)	20 Joule (IK 10)
INSTALLATION TEMPERATURE	-25 °C ÷ +60 °C	-25 °C ÷ +60 °C	-25 °C ÷ +60 °C	-25 °C ÷ +60 °C	-25 °C ÷ +60 °C
RESISTANCE TO HEAT	up to +125 °C	up to +125 °C	up to +125 °C	up to +125 °C	up to +125 °C
PROTECTION DEGREE	IP 65	IP 65	IP 65	IP 65	IP 65
MAX DISSIPATION POWER <sup>(1)</sup>	13 W	24 W	23 W	27 W	37 W
FLANGE FOR DIRECT BRANCH	-	COND. AND TRUNK Ø 5÷35 mm	COND. AND TRUNK Ø 5÷35 mm	COND. AND TRUNK Ø 5÷35 mm	COND. AND TRUNK Ø 5÷35 mm

(1) Data concerning dissipative power have been obtained by following the instructions in CEI 23-49 Standard, with a temperature difference of  $Dt = 30$  °C.

### IP 65 Europa Series switchboard for industrial applications

CODE	12 764-12 784	12 768-12 788	12 772-12 792	12 774-12 794	12 776-12 796	12 778-12 798
DIMENSIONS (mm)	140x220x140	205x220x140	275x220x140	275x370x140	275x570x140	380x570x140
COLOUR	RAL 7035 grey	RAL 7035 grey	RAL 7035 grey	RAL 7035 grey	RAL 7035 grey	RAL 7035 grey
WITH TRANSPARENT DOOR	YES	YES	YES	YES	YES	YES
WITH OPAQUE DOOR	YES	YES	YES	YES	YES	YES
DOUBLE INSULATION	YES	YES	YES	YES	YES	YES
RESISTANCE TO HEAT	GWT 960 °C	GWT 960° C	GWT 960° C	GWT 960° C	GWT 960° C	GWT 960° C
TYPE OF MATERIAL	Polycarbonate	Polycarbonate	Polycarbonate	Polycarbonate	Polycarbonate	Polycarbonate
SHOCK RESISTANCE	20 Joule (IK 10)	20 Joule (IK 10)	20 Joule (IK 10)	20 Joule (IK 10)	20 Joule (IK 10)	20 Joule (IK 10)
INSTALLATION TEMPERATURE	-25 °C ÷ +60 °C	-25 °C ÷ +60 °C	-25 °C ÷ +60 °C	-25 °C ÷ +60 °C	-25 °C ÷ +60 °C	-25 °C ÷ +60 °C
PROTECTION DEGREE	IP 65	IP 65	IP 65	IP 65	IP 65	IP 65
MAX DISSIPATION POWER <sup>(1)</sup>	10 W	19 W	25 W	40 W	61 W	75 W
FLANGE FOR DIRECT BRANCH	-	COND. AND TRUNK Ø 5÷35 mm	COND. AND TRUNK Ø 5÷35 mm	COND. AND TRUNK Ø 5÷35 mm	COND. AND TRUNK Ø 5÷35 mm	COND. AND TRUNK Ø 5÷35 mm
FIT FOR INSTALLING MCBs	-	-	-	YES	YES	YES
MOUNTING KIT	-	-	-	-	-	-
FIT FOR INSTALLING BASE PLATE	YES	YES	YES	YES	YES	YES
FIT FOR INSTALLING FIXED COUNTER-DOOR	-	-	-	YES	YES	YES

(1) Data concerning dissipative power have been obtained by following the instructions in CEI 23-49 Standard, with a temperature difference of  $Dt = 30$  °C.

# Further technical information and applications

## Switchboards and boxes – reaction to chemical agents

Reaction to chemical agents (\*)

	Cold water	Hot water	Sulphuric acid 40%	Hydrochloric acid 35%	Acetic acid 10%	Benzole	Gasoline	Acetone	Ethyl alcohol	Ammonia liquid	Dichloromethane	Diesel oil- naphta	Mineral oils and grases	Food oils and grases	Perchloroethylene	Trichloroethylene	Ethylether	Ozone	Toluene	Methanol	Spirits	Milk	Fruit juices	Fluoride hydrocarbons	Lye-washes	Cleansings	Water solution	
IP 65 Europa Series and blank front switchboards	■	▲	■	▲	■	●	■	●	■	●	●	▲	■	■	●	●	●	■	●	●	■	■	■	■	●	▲	▲	■
IP 65 Marostica Series switchboards	■	▲	■	▲	■	●	■	●	■	●	●	▲	■	■	●	●	●	■	●	●	■	■	■	■	●	▲	▲	■
IP 44 junction boxes with press-on lid	■	■	▲	▲	■	▲	▲	■	■	■	▲	■	■	■	●	●	▲	▲	●	■	■	■	■	■	▲	■	■	■
IP 55 junction boxes with screw-on lid	■	▲	■	■	■	●	■	●	■	■	●	■	■	■	●	●	●	▲	●	■	■	■	■	■	●	■	■	■
IP 65 junction boxes in polycarbonate	■	▲	■	▲	■	●	■	●	■	●	●	▲	■	■	●	●	●	■	●	●	■	■	■	■	●	▲	▲	■
Wiring accessories boxes	■	■	▲	▲	■	●	●	●	■	■	●	▲	▲	■	●	●	●	■	●	■	■	■	■	■	●	■	■	■

■ resistant ▲ partially resistant ● not resistant

VLCC00659



## Further technical information and applications

### Possible configurations of terminal holders – terminal bars for consumer units

Terminal holders and bars are supplied separately; in this way, by inserting one or two terminal bars in the terminal holders, you can create the best terminal for your requirements. All the possible configurations for creating each type of container are

given in the table below. Not only do you have the advantage of being able to create a personalised terminal but clearly there will be an economic advantage from using only that which is really necessary.

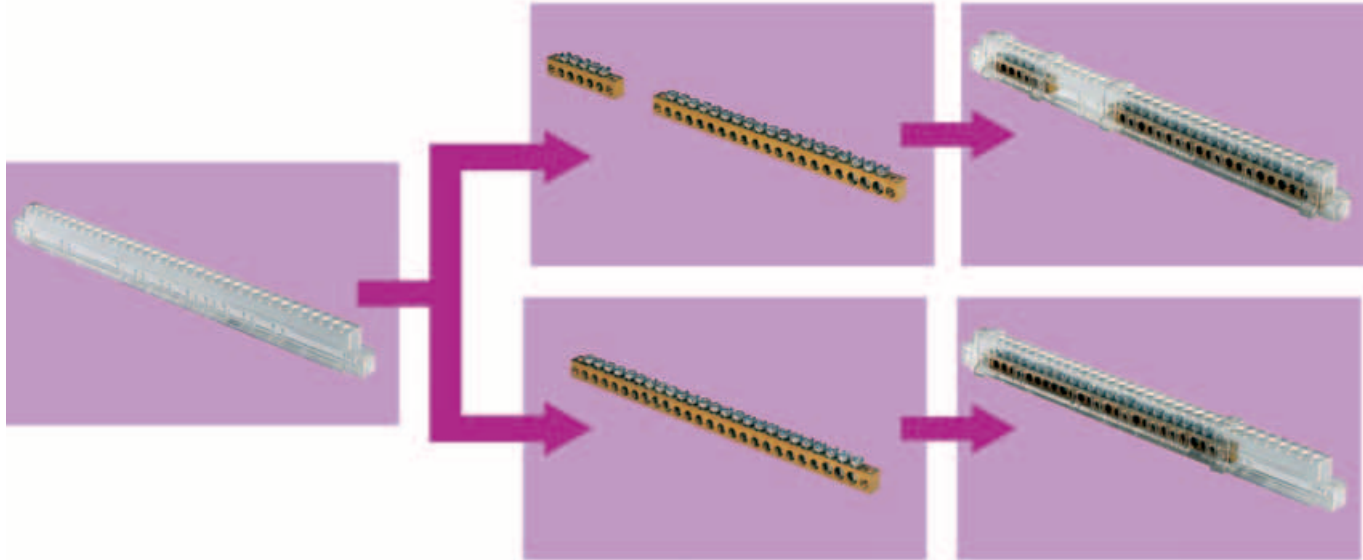

#### IP 40 Estetica Series flush-mounting consumer units

#### IP 40 Europa Series flush-mounting consumer units

#### IP 40 Unibox Series flush and wall-mounting consumer units

#### IP 40 Europa Series wall-mounting consumer units

For consumer units Number of modules	Terminal holder Code	Terminal bars Code x q.ty
8	12 540	12 531x1
	12 540	12 531x2
	12 540	12 531x1 with 12 532x1
	12 540	12 532x1
	12 540	12 533x1
	12 540	12 534x1
12	12 541	12 531x1
	12 541	12 531x2
	12 541	12 531x1 with 12 532x1
	12 541	12 531x1 with 12 533x1
24	12 541	12 531x1 with 12 534x1
	12 541	12 531x1 with 12 535x1
36 (12 modules x 3 rows)	12 541	12 532x1
	12 541	12 532x2
	12 541	12 533x1
	12 541	12 534x1
	12 541	12 535x1
18	12 542	12 531x1
	12 542	12 531x2
	12 542	12 531x1 with 12 532x1
	12 542	12 531x1 with 12 533x1
	12 542	12 531x1 with 12 534x1
	12 542	12 531x1 with 12 535x1
54	12 542	12 532x1
	12 542	12 532x2
	12 542	12 532x1 with 12 533x1
	12 542	12 532x1 with 12 534x1
	12 542	12 533x1
	12 542	12 534x1
	12 542	12 535x1

For consumer units Number of modules	Terminal holder Code	Terminal bars Code x q.ty
8	12 540	12 531x1
	12 540	12 531x2
	12 540	12 531x1 with 12 532x1
	12 540	12 532x1
	12 540	12 533x1
	12 540	12 534x1
12	12 541	12 531x1
	12 541	12 531x2
	12 541	12 531x1 with 12 532x1
	12 541	12 531x1 with 12 533x1
24	12 541	12 531x1 with 12 534x1
	12 541	12 531x1 with 12 535x1
36 (12 modules x 3 rows)	12 541	12 532x1
	12 541	12 532x2
	12 541	12 533x1
	12 541	12 534x1
	12 541	12 535x1
54	12 543	12 531x1
	12 543	12 531x2
	12 543	12 531x1 with 12 532x1
	12 543	12 531x1 with 12 533x1
	12 543	12 531x1 with 12 534x1
	12 543	12 531x1 with 12 535x1
	12 543	12 532x1
	12 543	12 532x2
	12 543	12 532x1 with 12 533x1
	12 543	12 532x1 with 12 534x1
	12 543	12 532x1 with 12 535x1
	12 543	12 533x1
	12 543	12 533x2
	12 543	12 533x1 with 12 534x1
12 543	12 534x1	
12 543	12 534x2	
12 543	12 535x1	

## Further technical information and applications

### Possible configurations of terminal holders – terminal bars for consumer units

#### IP 40 Europa Series wall-mounting consumer units

#### IP 65 Europa Series wall-mounting consumer units

#### IP 65 Fly Series wall-mounting consumer units

For consumer units Number of modules	Terminal holder Code	Terminal bars Code x q.ty
4	12 538	12 531x1
8	12 539	12 531x1
12	12 540	12 531x1
24	12 540	12 531x2
36	12 540	12 531x1 with 12 532x1
(12 mod. x 3 rows)	12 540	12 532x1
	12 540	12 533x1
	12 540	12 534x1
	12 543	12 531x1
	12 543	12 531x2
	12 543	12 531x1 with 12 532x1
	12 543	12 531x1 with 12 533x1
18	12 543	12 531x1 with 12 534x1
	12 543	12 531x1 with 12 535x1
36	12 543	12 532x1
(18 mod.x 2 rows)	12 543	12 532x2
	12 543	12 532x1 with 12 533x1
	12 543	12 532x1 with 12 534x1
54	12 543	12 532x1 with 12 535x1
	12 543	12 533x1
	12 543	12 533x2
	12 543	12 533x1 with 12 534x1
	12 543	12 534x1
	12 543	12 534x2
	12 543	12 535x1

#### Europa Series consumer units for industrial applications

For boxes dimensions	Terminal holder Code	Terminal bars Code x q.ty
140x220x140	12 538	12 531x1
205x220x140	12 539	12 531x1
	12 540	12 531x1
	12 540	12 531x2
275x220x140	12 540	12 531x1 with 12 532x1
275x370x140	12 540	12 532x1
275x570x140	12 540	12 533x1
	12 540	12 534x1
	12 543	12 531x1
	12 543	12 531x2
	12 543	12 531x1 with 12 532x1
	12 543	12 531x1 with 12 533x1
	12 543	12 531x1 with 12 534x1
	12 543	12 531x1 with 12 535x1
	12 543	12 532x1
	12 543	12 532x2
	12 543	12 532x1 with 12 533x1
	12 543	12 532x1 with 12 534x1
	12 543	12 532x1 with 12 535x1
	12 543	12 533x1
	12 543	12 533x2
	12 543	12 533x1 with 12 534x1
	12 543	12 534x1
	12 543	12 534x2
	12 543	12 535x1

# Further technical information and applications

## Possible configurations of terminal holders – terminal bars for consumer units

### Switchboards with blank front for industrial applications

For boxes dimensions	Terminal holder Code	Terminal bars Code x q.ty
275x370x140	12 540	12 531x1
	12 540	12 531x2
275x455x140	12 540	12 531x1 with 12 532x1
275x570x140	12 540	12 532x1
	12 540	12 533x1
	12 540	12 534x1
	12 543	12 531x1
	12 543	12 531x2
	12 543	12 531x1 with 12 532x1
	12 543	12 531x1 with 12 533x1
	12 543	12 531x1 with 12 534x1
	12 543	12 531x1 with 12 535x1
	12 543	12 532x1
	12 543	12 532x2
	12 543	12 532x1 with 12 533x1
	12 543	12 532x1 with 12 534x1
	12 543	12 532x1 with 12 535x1
	12 543	12 533x1
	12 543	12 533x2
	12 543	12 533x1 with 12 534x1
	12 543	12 534x1
	12 543	12 534x2
	12 543	12 535x1

### IP65 junction boxes in polycarbonate

For boxes dimensions	Terminal holder Code	Terminal bars Code x q.ty
140x220x140	12 538	12 531x1
205x220x140	12 539	12 531x1
	12 540	12 531x1
275x220x140	12 540	12 531x2
	12 540	12 531x1 with 12 532x1
275x370x140	12 540	12 532x1
275x570x140	12 540	12 533x1
	12 540	12 534x1
	12 543	12 531x1
	12 543	12 531x2
	12 543	12 531x1 with 12 532x1
	12 543	12 531x1 with 12 533x1
	12 543	12 531x1 with 12 534x1
	12 543	12 531x1 with 12 535x1
	12 543	12 532x1
	12 543	12 532x2
380x570x140	12 543	12 532x1 with 12 533x1
	12 543	12 532x1 with 12 534x1
	12 543	12 532x1 with 12 535x1
	12 543	12 533x1
	12 543	12 533x2
	12 543	12 533x1 with 12 534x1
	12 543	12 534x1
	12 543	12 534x2
	12 543	12 535x1

# Further technical information and applications

## Enclosures and boxes for light prefabrication

To install the wiring accessories boxes in light prefabricated walls, a wide range of special cutters is available; the mounting sequence is indicated as follows.

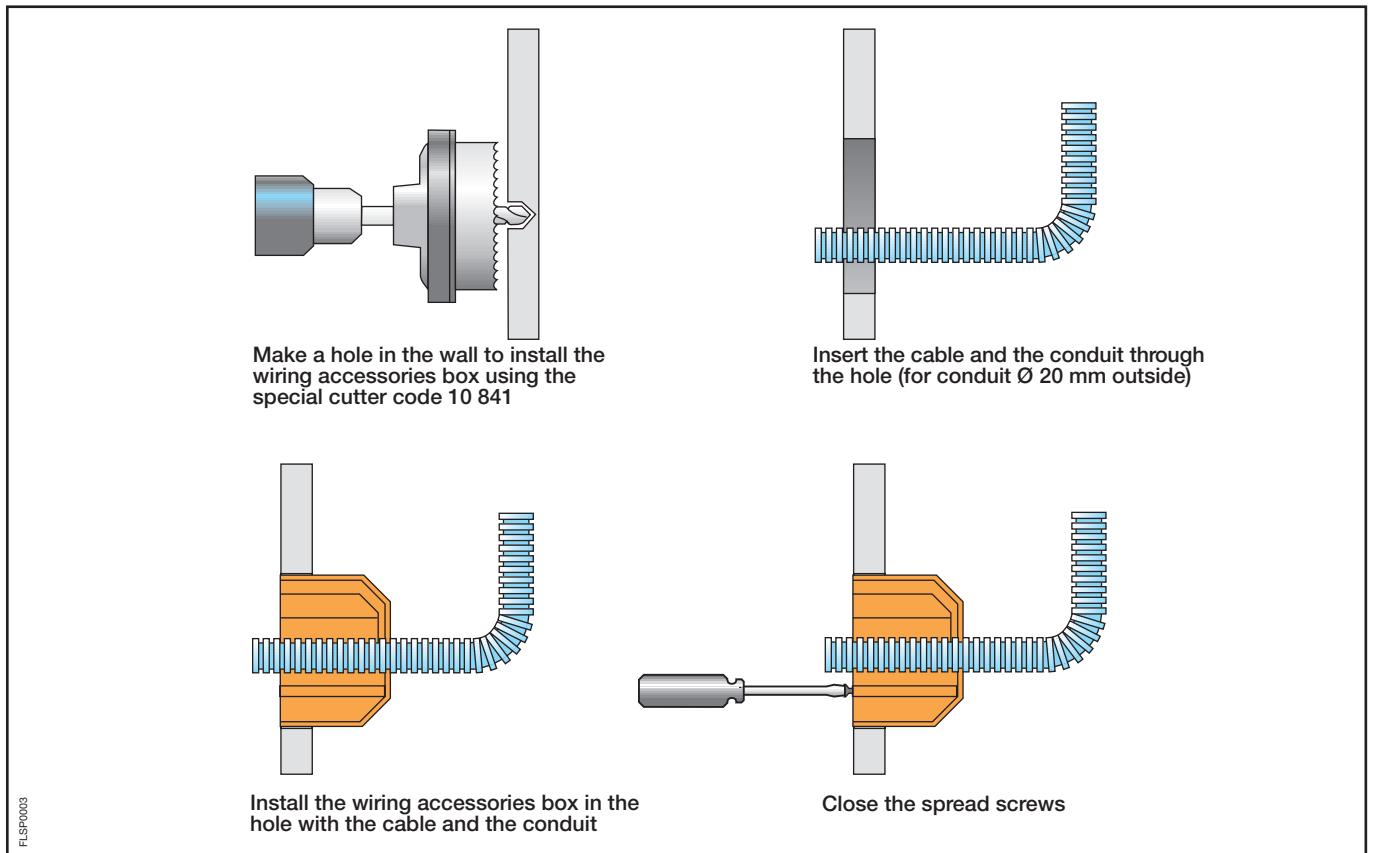

The same cutters can be used to install wiring accessories modular boxes and boxes for operating consumer units, as shown in the following pictures.

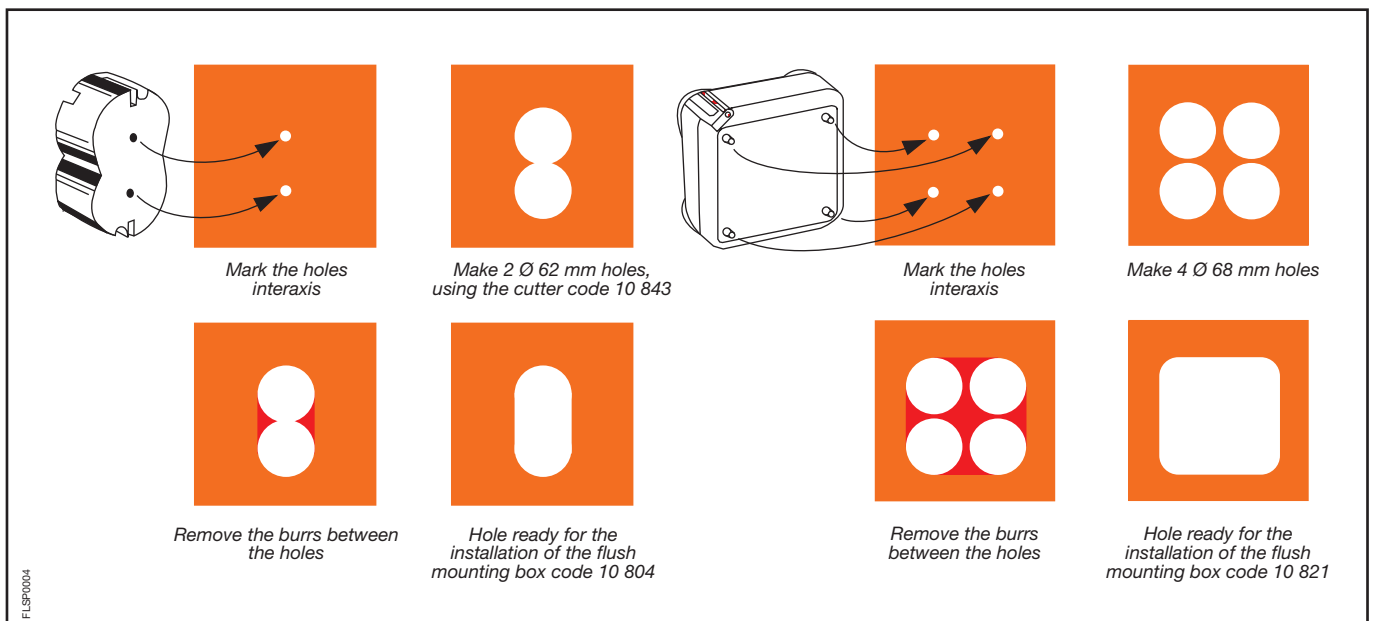

# Further technical information and applications

## Mounting examples and functional details

### Flush-mounting Unibox, Europa and Estetica Series



1SLC001068F0001

▲ By combining the copper terminal bars to the corresponding plastic terminal holders, according to the configuration, the consumer unit terminal can be fitted with Neutral (N) or Earth (E).

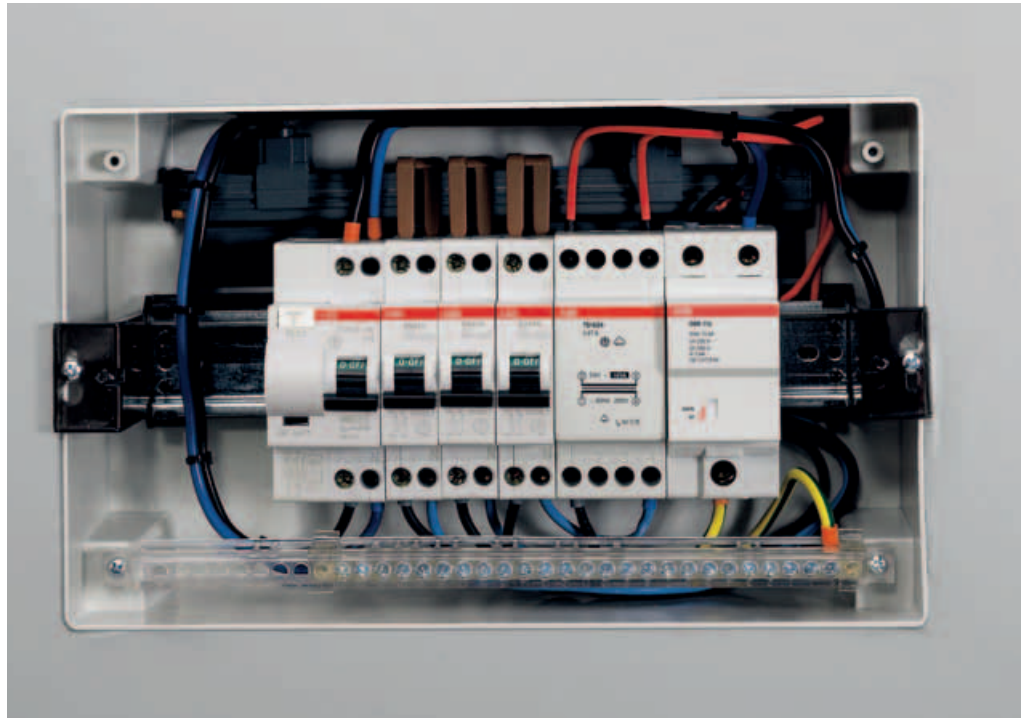

1SLC001068F0001

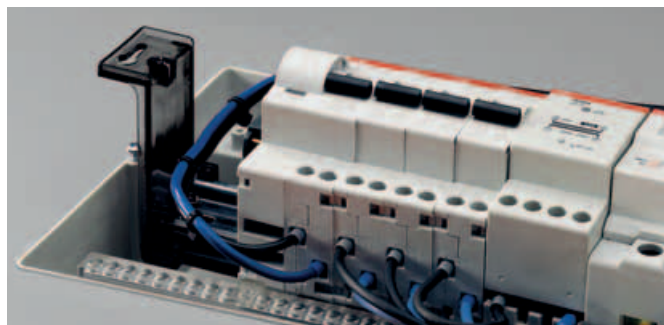

▲ An extractable frame is available also in the single row version, making bench cabling operations easier.

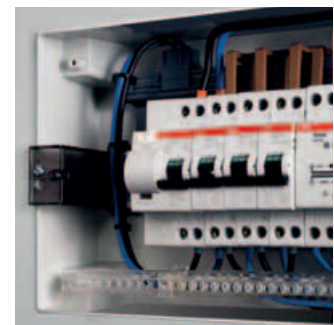

▲ The handy slots made to attach the unit to the frame guarantee correct alignment even when the flush-mounting box has not been installed on perfectly flat surfaces.

1SLC001068F0001

# Further technical information and applications

## Mounting examples and functional details

### Flush-mounting Europa Series



▲ The extractable DIN rail frame makes bench cabling easy.

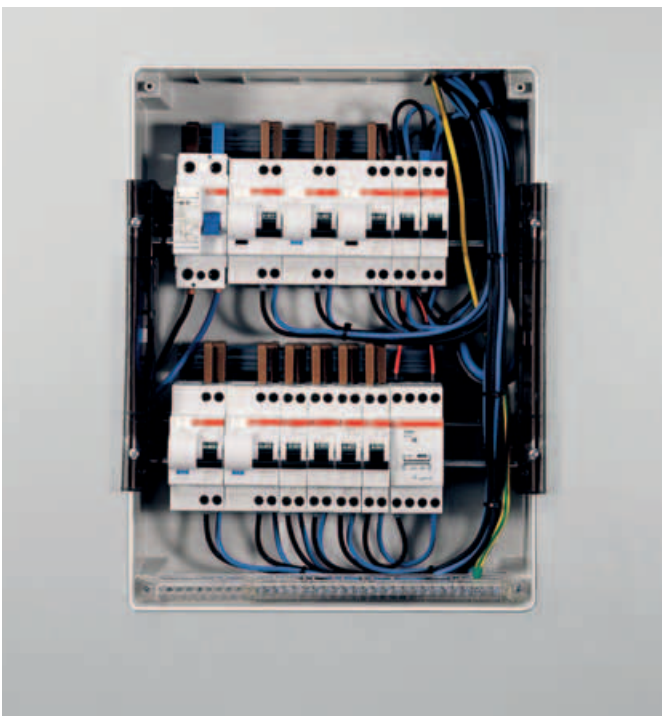

▲ The two housings on the sides of the front ensure that the door is completely reversible and therefore it can be mounted on the right or on the left according to specific requirements.

◀ The roomy interiors make cabling easy and simple.



# Further technical information and applications

## Mounting examples and functional details

### Wall-mounting Unibox Series

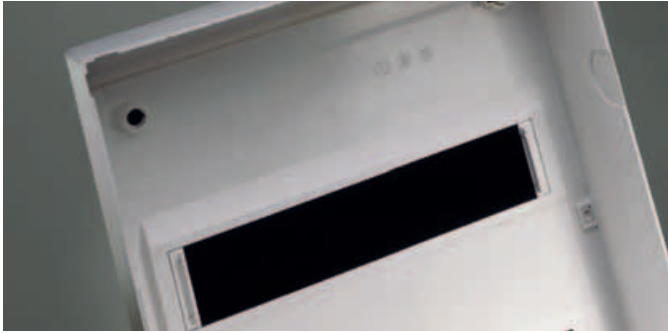

FLCO9881

▲ The knockout cut halfway down the module on both sides makes it possible to fit an extra module corresponding to each row of circuit breakers.

The cover is fitted using rapid pitch ▶ screws in insulating thermo-plastic that can be lead-sealed if necessary.



FLCO9810

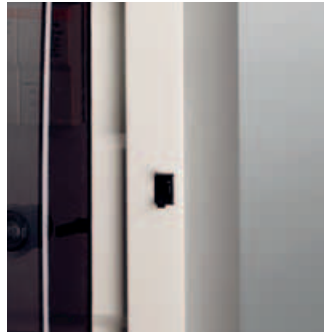

FLCO9840

▲ The push-pull mechanism means that the door can be closed easily.



FLCO9874

▲ The door can be fitted with a lock with a coded key.

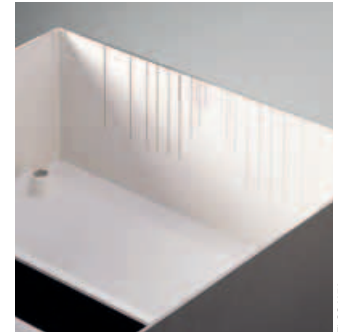

FLCO9876

▲ The knockouts in the cover give maximum flexibility in trunking branch connections.



FLCO9877

▲ The accurate alignment system engraved on the top and bottom of the base of the consumer unit makes it easy to position the branch connection trunking.



FLCO9838

▲ The consumer unit is designed with a flange so that it can be used for branch connection using a conduit; the knockouts make it possible to make branch connections with conduits with a maximum diameter of 40 mm.

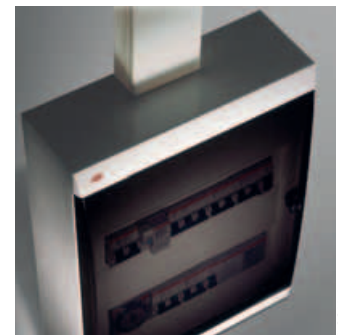

FLCO9879



# Further technical information and applications

## Mounting examples and functional details

### Wall-mounting Unibox Series



FLC09819



FLC09819

▲ Thanks to plenty of room under the DIN rail it is possible to install the cables tidily and rationalise their paths.



FLC09872

▲ A characteristic of consumer units in the UNIBOX Series is the frame, which can be kept in an angled position thanks to practical wires, making it easier to work on the connection cables.

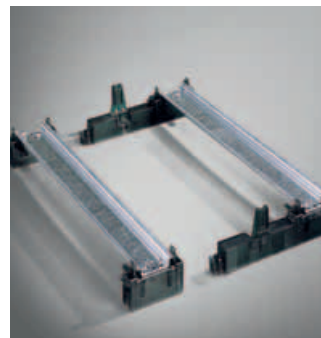

FLC09873

▲ The modular, snap-on frame is easy to extract and is therefore ideal for bench cabling.

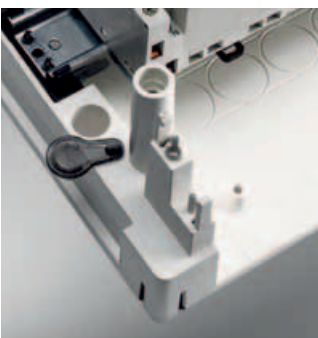

FLC09837

▲ The special caps used to cover the holes for attaching to the wall ensure that the consumer unit is double insulated.



FLC09875

▲ The base, on which push-in inlets have been made, is specially designed for the installation of corrugated conduits coming from the wall.

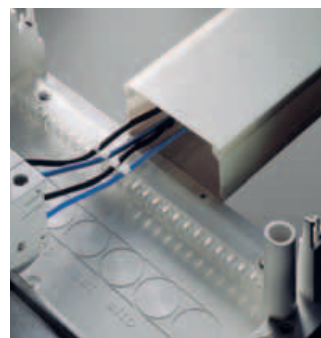

FLC09880

▲ The practical holding system secures the incoming and outgoing cables to a special comb accessory, which not only keeps the cables tidy but also protects the devices' terminals from any direct mechanical contact.

## Further technical information and applications

### Mounting examples and functional details



1SLC001088F001

▲ Thanks to the expanded polyurethane seal inserted between the door and the front of the consumer unit, using the continuous casting process, the IP 65 protection degree is guaranteed, also making it impossible to lose the seal itself.



FLC0824

▲ The door is designed so that a lock with a coded key can be fitted.



1SLC001089F001

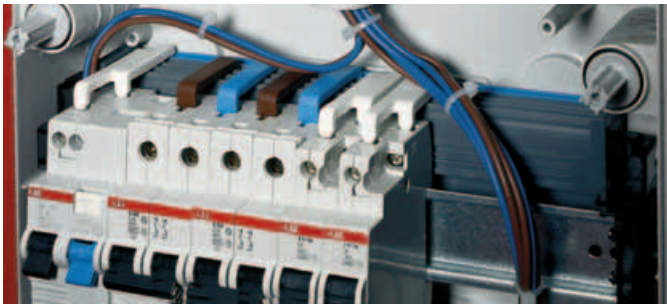

FLC0821

▲ Models with 8 modules and more have been designed to use the UNIFIX L rapid cabling system.

By combining the copper terminal bars to the corresponding plastic terminal holders, according to the configuration, the consumer unit terminal can be fitted with Neutral (N) or Earth (E).

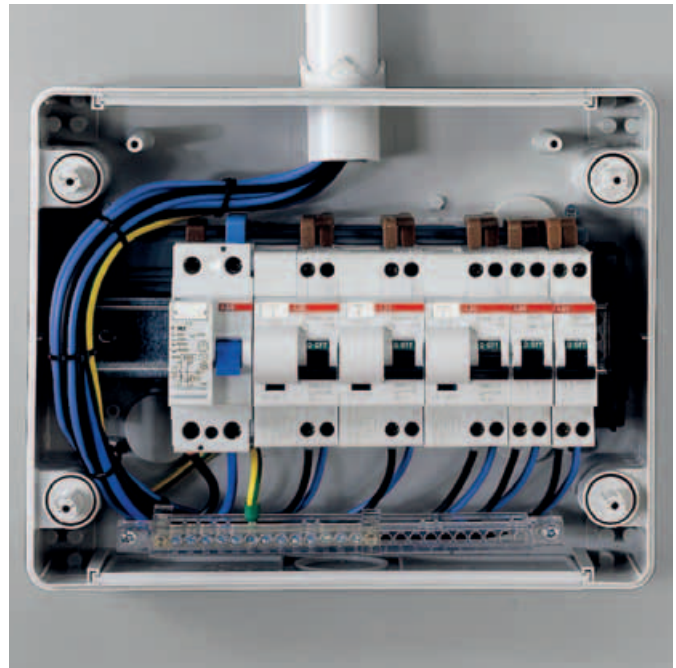

1SLC001070F001

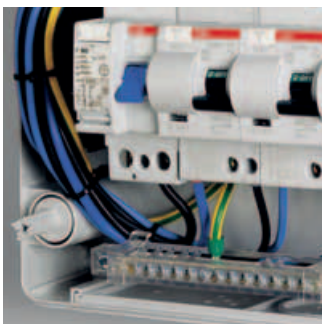

1SLC001071F001

The push-in flange makes it possible to carry out direct conduit and cable branch connections without having to use cable clamps, conduit clamps or connectors, with an obvious saving in terms of time and cabling costs.

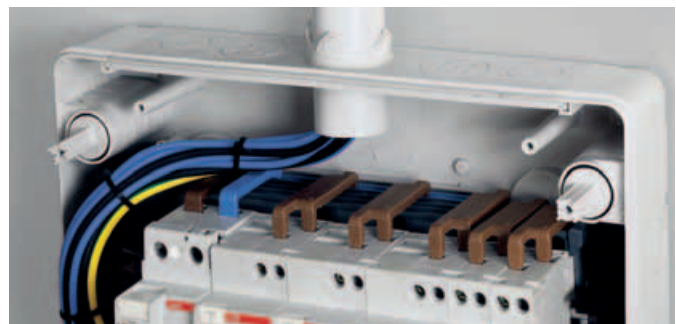

1SLC001072F001



# Further technical information and applications

## Mounting examples and functional details

### IP 65 Fly and Europa Series



▲ When fixing the unit to the wall from the inside, the special hole caps ensure double insulation is maintained.



▲ Using the brackets it is easy to fix the consumer unit in any environment.



▲ The frame that can be fitted onto the consumer unit makes semi-flush mounting possible, guaranteeing an attractive finish.



◀ Using the special hinges supplied the cover can be secured to the frame to make maintenance work easier.

◀ The snap-on, extractable DIN rail frame simplifies and speeds up bench cabling operations.

## Further technical information and applications

### Branch connections using the bi-material flange

DIRECT APPLICATION WITH CONDUIT OR CABLE

#### from 5 to 16 mm

Make a hole where indicated using a screw driver to insert cables or conduits with a diameter of from 5 to 16 mm

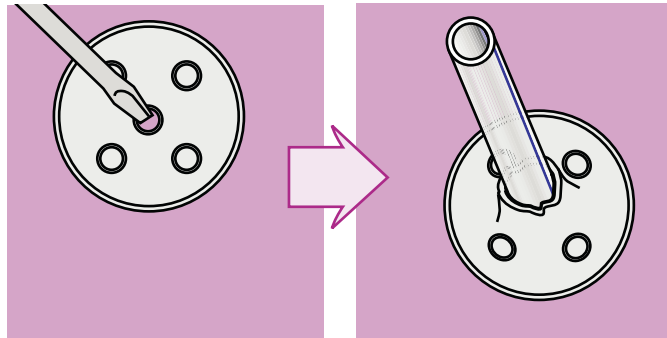

#### from 17 to 20 mm

To insert cables or conduits up to 20 mm, make holes in the points indicated using a screwdriver and cut the rubber using scissors

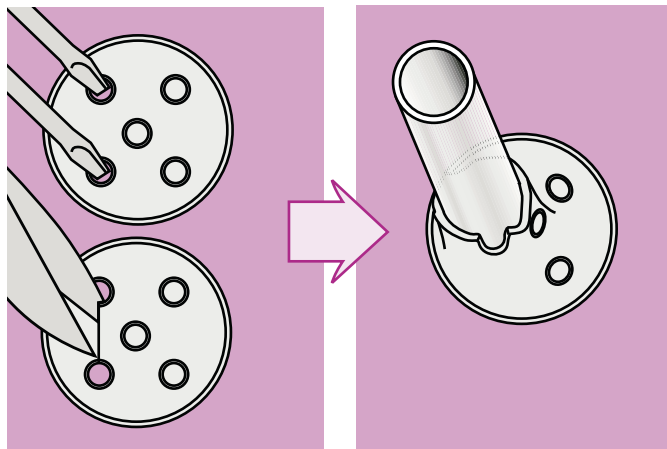

#### from 21 to 24 mm

To insert cables or conduits up to 24 mm, make holes in the points indicated using a screwdriver and cut the rubber using scissors

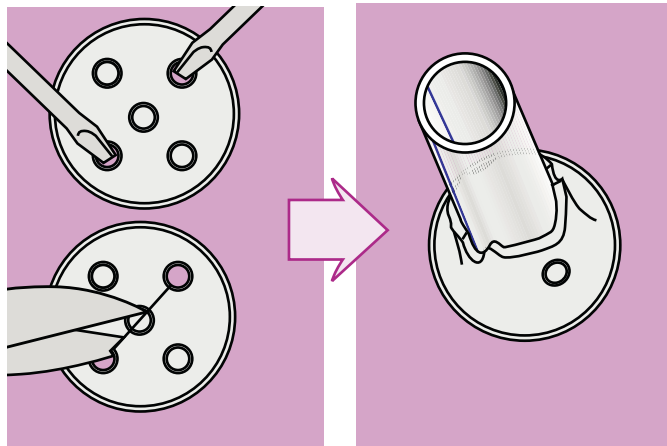

#### from 25 to 35 mm

To insert cables with a diameter up to 35 mm and conduits up to 32 mm, make holes in the points indicated using a screwdriver and cut the rubber using scissors

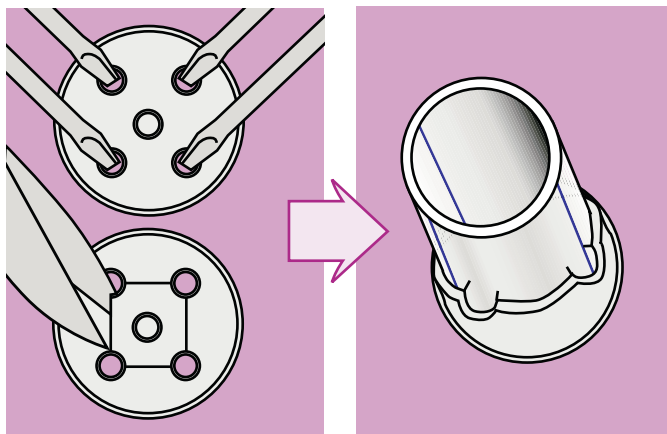

How to insert cables and conduits.

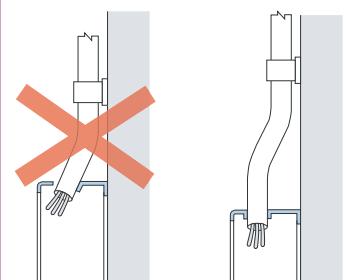

# Further technical information and applications

## Branch connections using the bi-material flange

APPLICATION WITH CONDUIT OR CABLE CLAMPS

# 1

Possible extraction of the flange

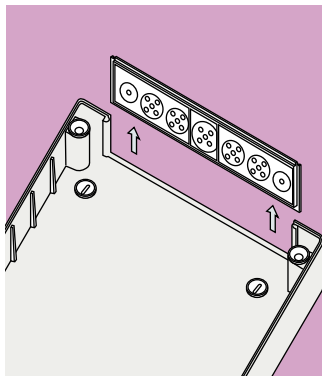

# 4

Inserting the flange into the base of the enclosure

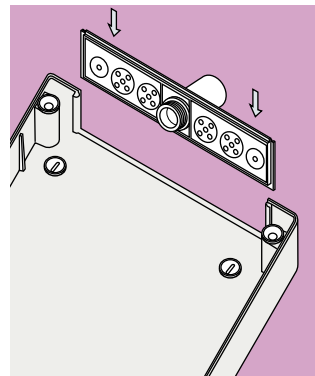

# 2

Identification and cutting of the suitable inlet (you must remove all the soft part)

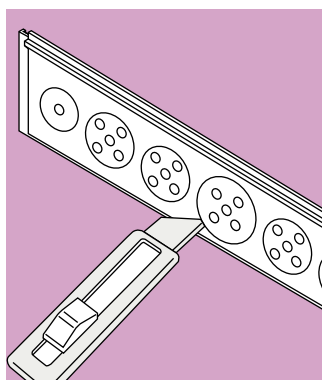

# 5

Fixing the base of the enclosure to the wall

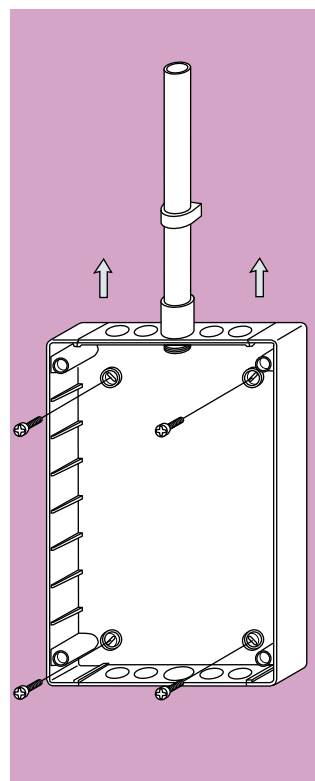

# 3

Branch connection using the conduit/cable clamp box connector

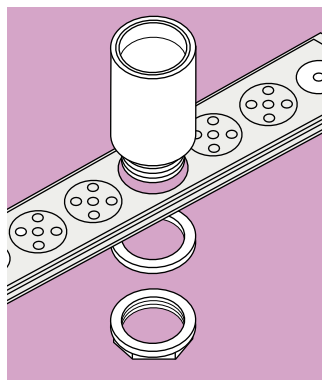

9

Suitable ABB codes for branch connection with flange in bi-material

Inlets for flange [mm]	Cable-gland [mm]	Conduit clamp - box connector [mm]
Ø 23.5	<b>00 934 - 00 944</b> PG 16 (Ø 13/16)	<b>00 431</b> Ø 20
Ø 30	<b>00 935 - 00 945</b> PG 21 (Ø 17/29)	<b>00 432</b> Ø 25
Ø 37.5	<b>00 936 - 00 946</b> PG 29 (Ø 21/26)	<b>00 433</b> Ø 32





## Index

IP 40 Unibox Series flush-mounting consumer units .....	10/2
IP 40 Estetica Series flush-mounting consumer units.....	10/4
IP 40 Europa Series flush-mounting consumer units .....	10/6
IP 40 Unibox Series wall-mounting consumer units .....	10/8
IP 40 Europa Series wall-mounting consumer units .....	10/10
IP 40 Europa Polycarbonate Series wall-mounting consumer units .....	10/12
IP 40 wall-mounting covers.....	10/14
IP 55 Europa Series wall-mounting consumer units .....	10/16
IP 65 Fly Series wall-mounting consumer units .....	10/18
IP 65 Europa Series wall-mounting consumer units .....	10/20
IP 40 panel fronts .....	10/22
IP 55 panel fronts .....	10/23
Livorno Series flush and wall-mounting emergency consumer units.....	10/24
Europa Series switchboards for industrial applications .....	10/26
Switchboards for industrial applications with blank front .....	10/28
IP 44 and IP 55 junction boxes in thermoplastic material.....	10/30
IP 65 junction boxes in polycarbonate .....	10/33
IP 40 equipment and empty enclosures.....	10/35
IP 55 equipment and empty enclosures.....	10/36
Various components.....	10/37
Enclosures and boxes for light prefabrication.....	10/38
Wiring accessories and junction boxes in thermoplastic material .....	10/40
Installation material .....	10/42
Accessories .....	10/46



# Overall dimensions

## IP 40 Unibox Series flush-mounting consumer units

### Front view

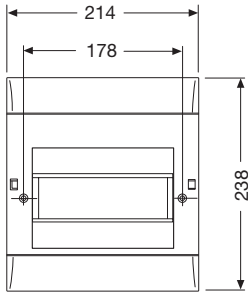

8 modules

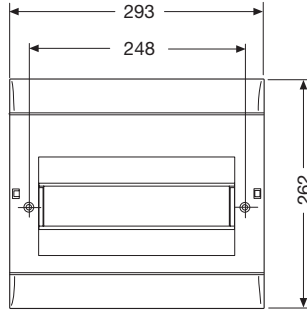

12 modules

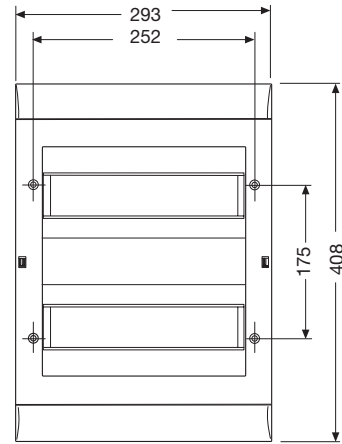

24 modules

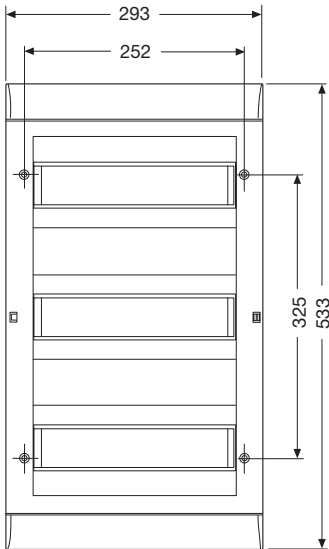

36 modules

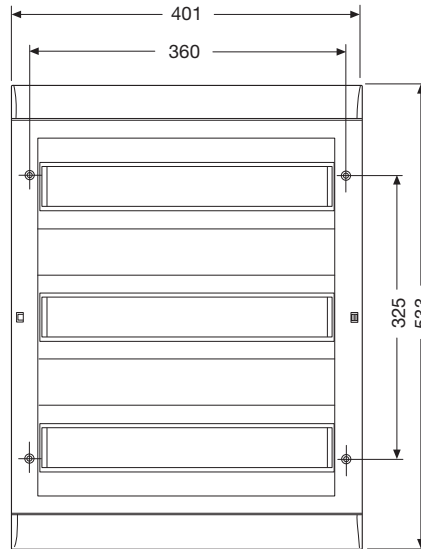

54 modules

### Side view

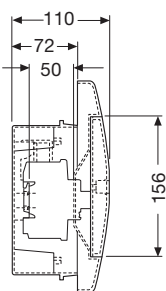

8 modules

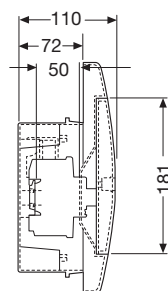

12 modules

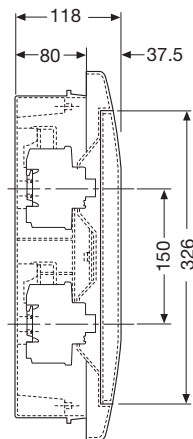

24 modules

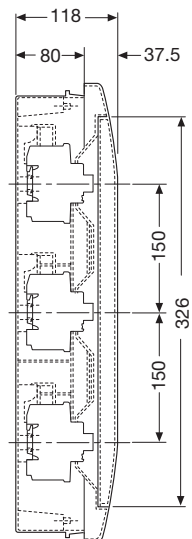

36/54 modules

1L000665

# Overall dimensions

## IP 40 Unibox Series flush-mounting consumer units

### Drilling sheets

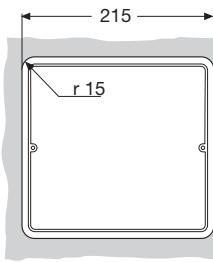

8 modules

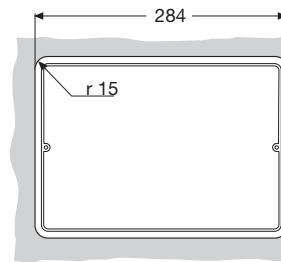
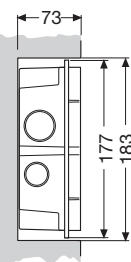

12 modules

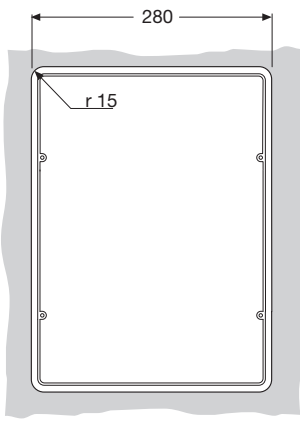
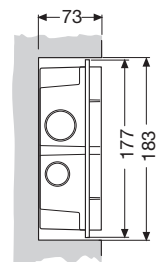

24 modules

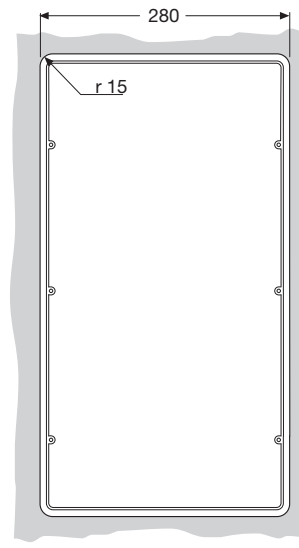
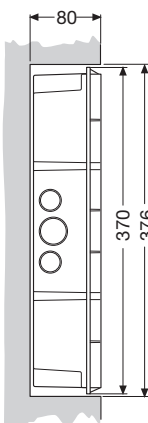

36 modules

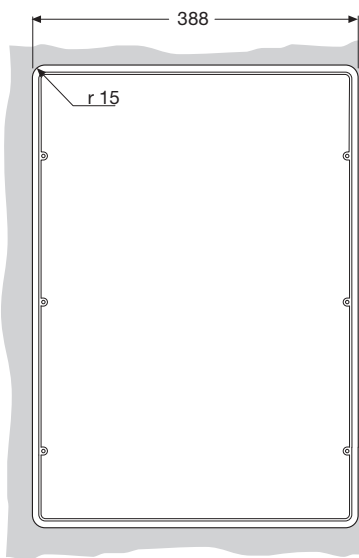
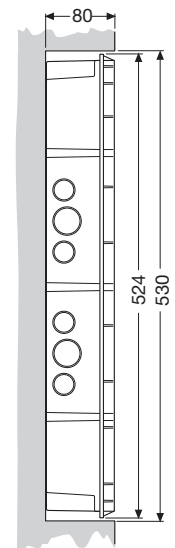

54 modules

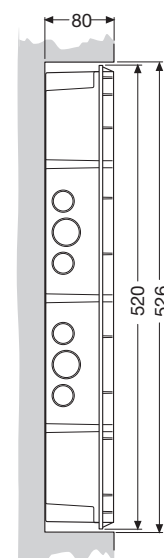

modules	code
8 modules	1SL0500A00 - 1SL0521A00 - 1SL0533A00 - 1SL0510A00 - 1SL0521A00 - 1SL0532A00 - 1SL0510A06 - 1SL0500A06
12 modules	1SL0511A00 - 1SL0522A00 - 1SL0536A00 - 1SL0501A00 - 1SL0522A00 - 1SL0537A00 - 1SL0511A06 - 1SL0501A06
24 modules	1SL0512A00 - 1SL0502A00 - 1SL0512A06 - 1SL0502A06
36 modules	1SL0513A00 - 1SL0503A00 - 1SL0513A06 - 1SL0503A06
54 modules	1SL0514A00 - 1SL0504A00 - 1SL0514A06 - 1SL0504A06

VLC000066

# Overall dimensions

## IP 40 Estetica Series flush-mounting consumer units

### Front view

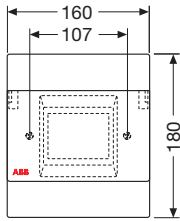

4 modules

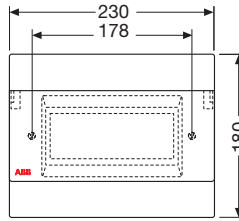

8 modules

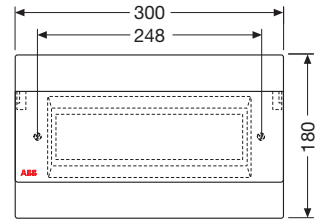

12 modules

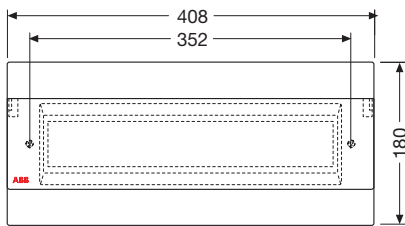

18 modules

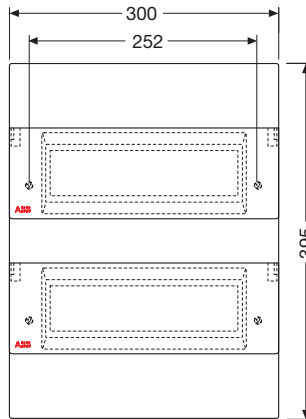

24 modules

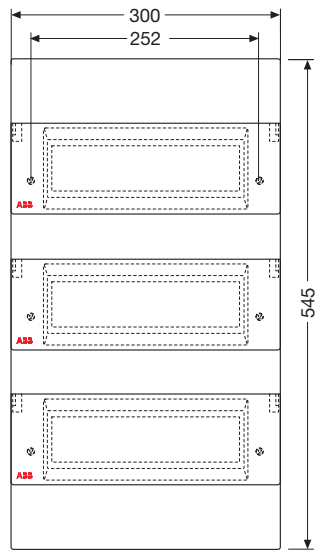

36 modules

### Side view

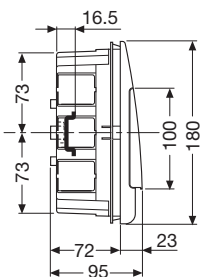

4 modules

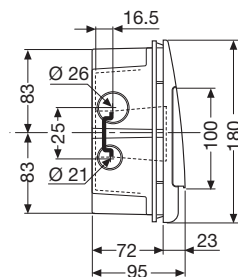

8/12/18 modules

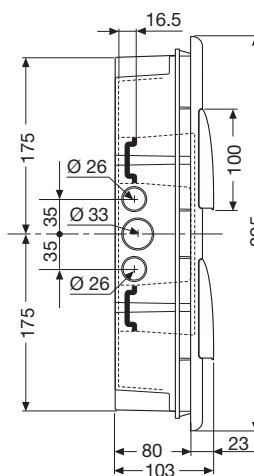

24 modules

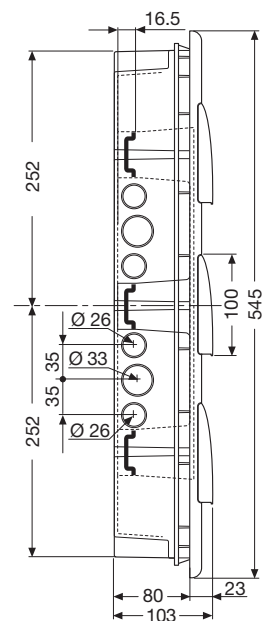

36 modules

# Overall dimensions

## IP 40 Estetica Series flush-mounting consumer units

### Drilling sheet

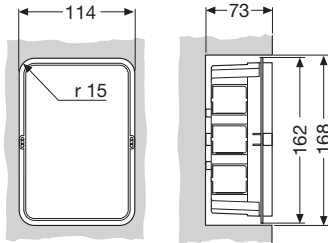

4 modules

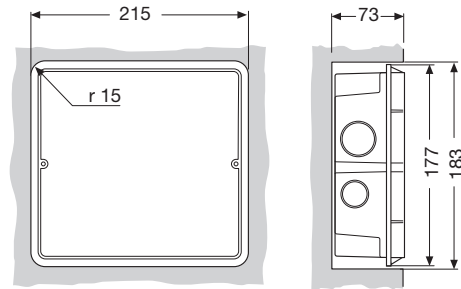

8 modules

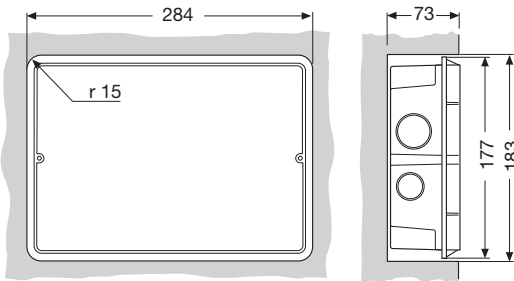

12 modules

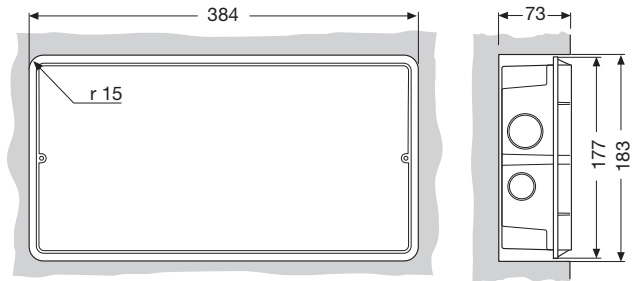

18 modules

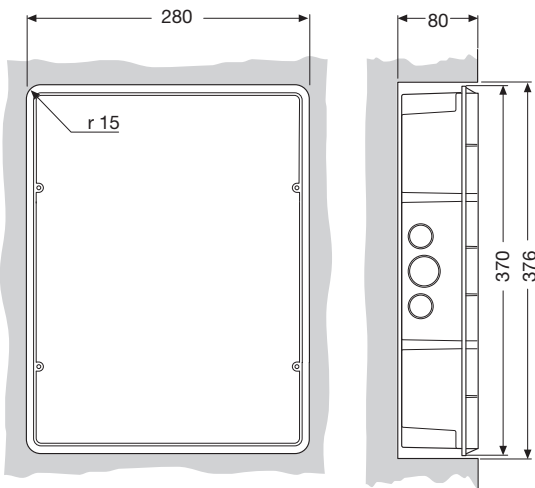

24 modules

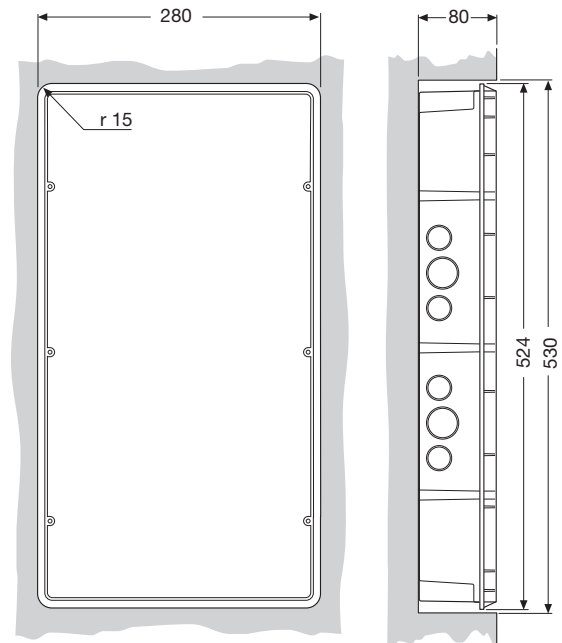

36 modules

modules	code
4 modules	1SL2024A00 - 12 037 - 1SL0531A00 - 1SL0553A00
8 modules	1SL2028A00 - 12 038 - 1SL0535A00 - 1SL0554A00
12 modules	1SL2032A00 - 12 042 - 1SL0539A00 - 1SL0555A00
18 modules	1SL2033A00 - 12 043 - 1SL0541A00 - 1SL0556A00
24 modules	1SL2034A00 - 12 044
36 modules	1SL2036A00 - 12 046

VL000002

# Overall dimensions

## IP 40 Europa Series flush-mounting consumer units

### Front view

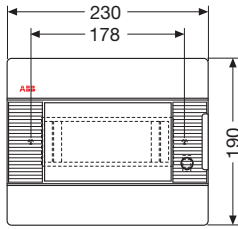

8 modules

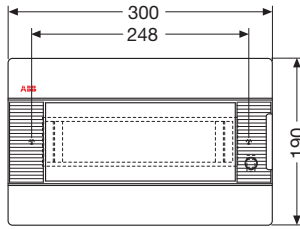

12 modules

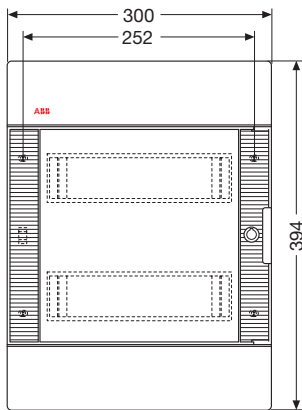

24 modules

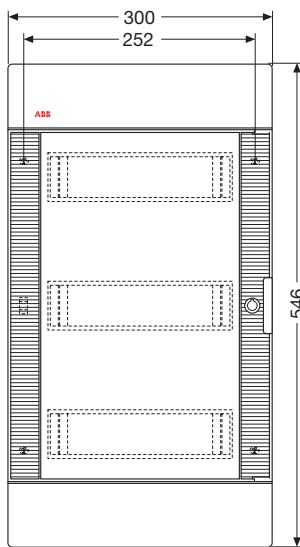

36 modules

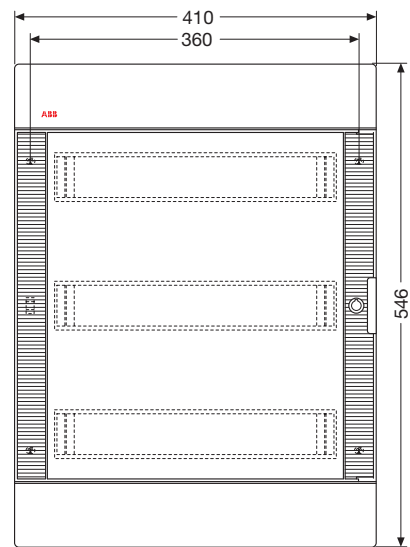

54 modules

### Side view

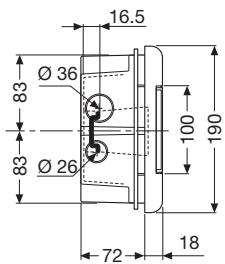

8/12 modules

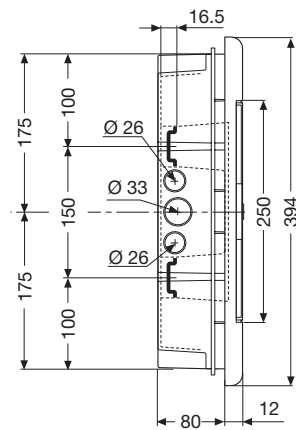

24 modules

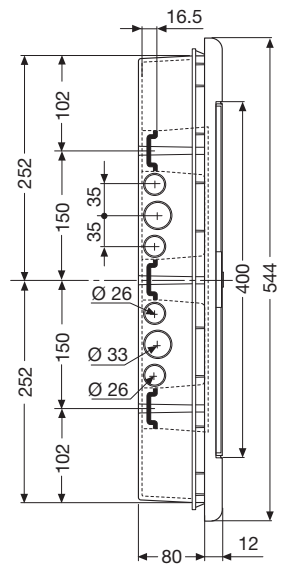

36/54 modules

V1000003

# Overall dimensions

## IP 40 Europa Series flush-mounting consumer units

### Drilling sheets

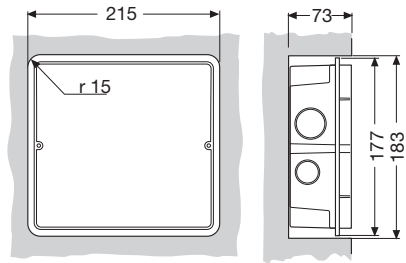

8 modules

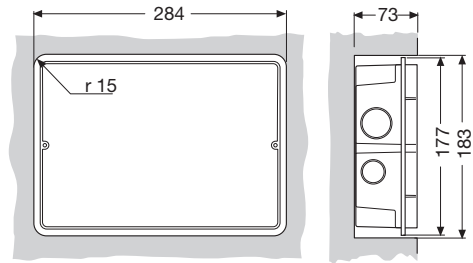

12 modules

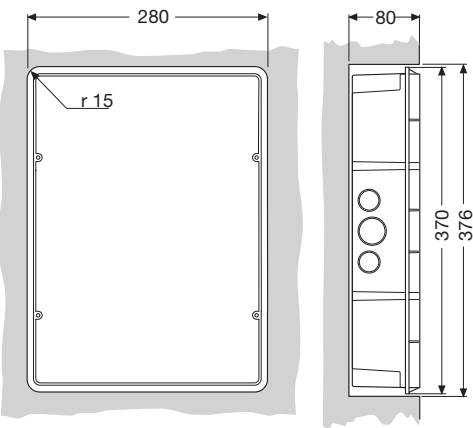

24 modules

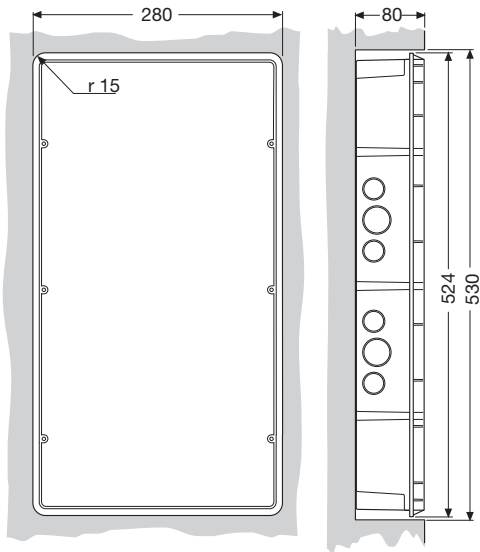

36 modules

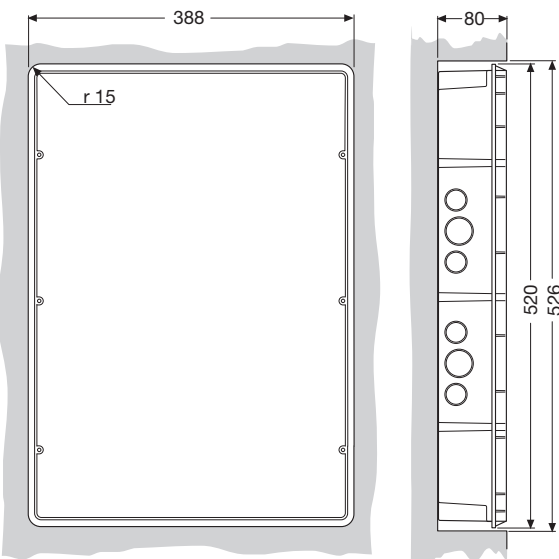

54 modules

modules	code
8 modules	1SL2040A00 - 12 026 - 1SL2057A00 - 12 058 - 1SL2040A06 - 1SL2057A06
12 modules	1SL2041A00 - 12 027 - 1SL2061A00 - 12 062 - 1SL2041A06 - 1SL2061A06
24 modules	1SL2045A00 - 12 030 - 1SL2063A00 - 12 064 - 1SL2045A13 - 1SL2063A13
36 modules	1SL2048A00 - 12 031 - 1SL2065A00 - 12 066 - 1SL2048A14 - 1SL2065A14
54 modules	1SL2052A00 - 12 035 - 1SL2067A00 - 12 068 - 1SL2052A06 - 1SL2067A06

MLC00004



# Overall dimensions

## IP 40 Unibox Series wall-mounting consumer units

### Front view

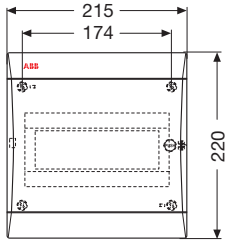

8 modules

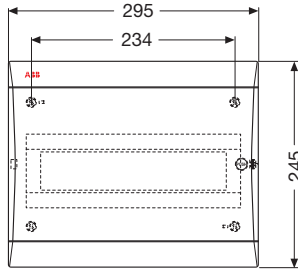

12 modules

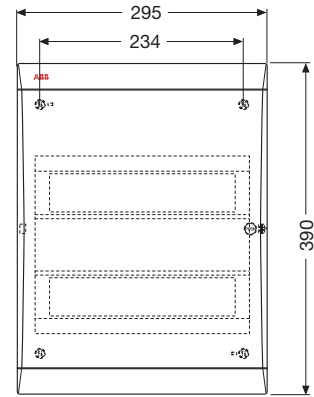

24 modules

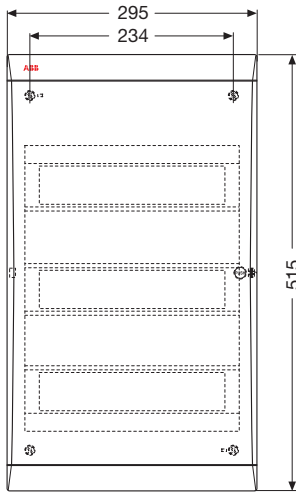

36 modules

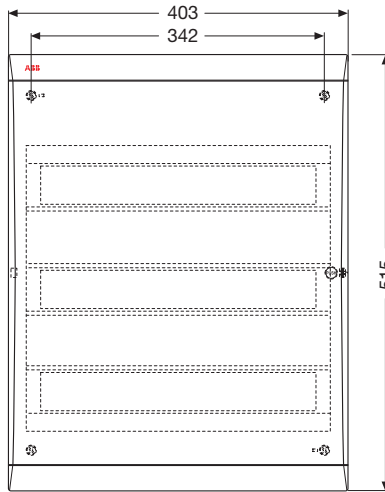

54 modules

### Side view

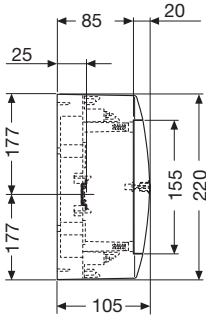

8 modules

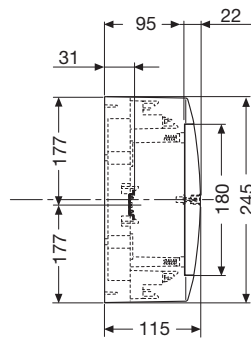

12 modules

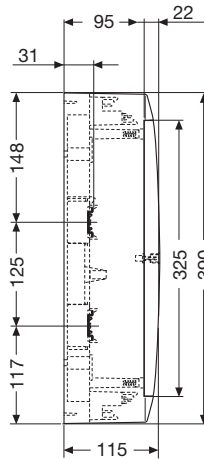

24 modules

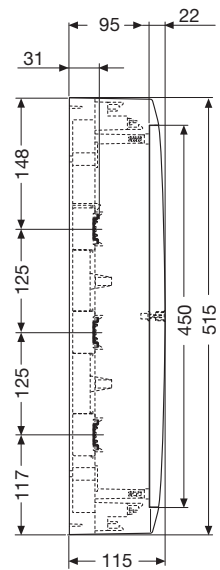

36-54 modules

V.LC00005

# Overall dimensions

## IP 40 Unibox Series wall-mounting consumer units

### Drilling sheets

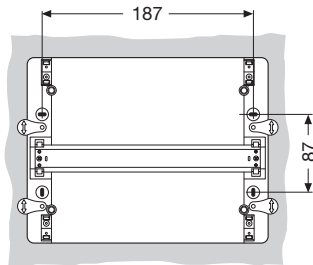

8 modules

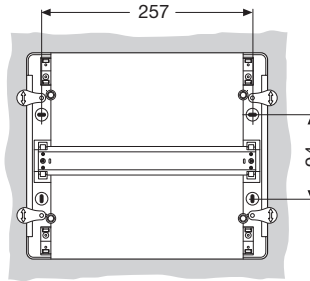

12 modules

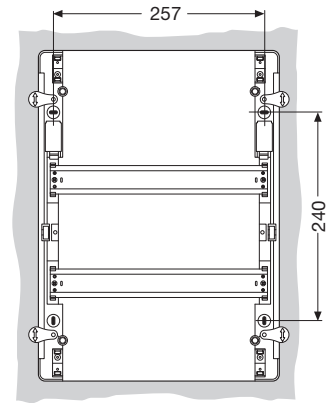

24 modules

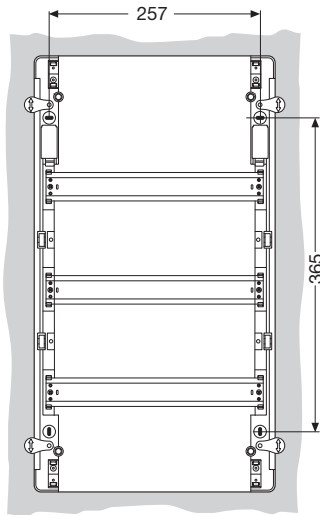

36 modules

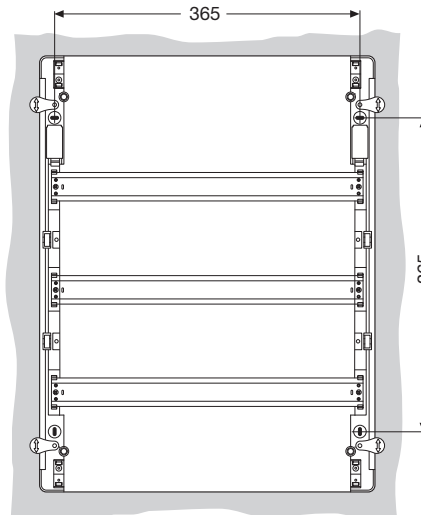

54 modules

modules	code
8 modules	12 208 - 12 238 - 12 258 - M12238000U - M12258000U
12 modules	12 212 - 12 242 - 12 262 - M12242000A - M12262000A
24 modules	12 214 - 12 244 - 12 264 - M12244000U - M12264000U
36 modules	12 216 - 12 246 - 12 266 - M12246000U - M12266000U
54 modules	12 217 - 12 247 - 12 267 - M12247000U - M12267000U

VLC00006

# Overall dimensions

## IP 40 Europa Series wall-mounting consumer units

### Front view

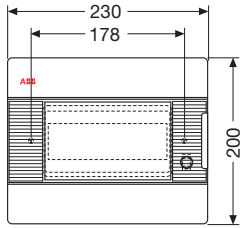

8 modules

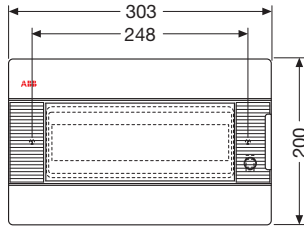

12 modules

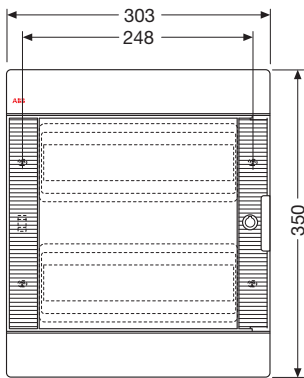

24 modules

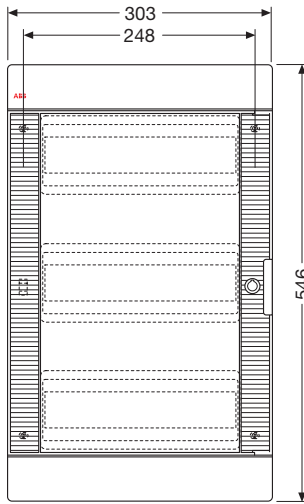

36 modules

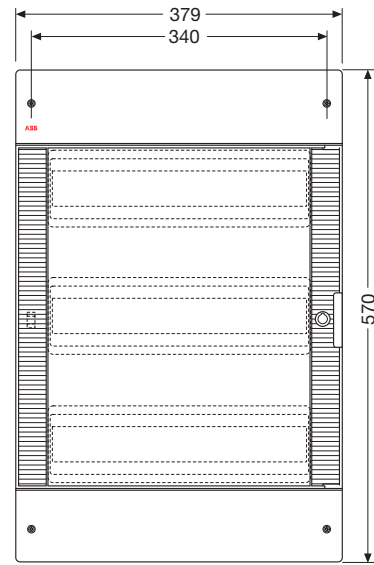

54 modules

### Side view

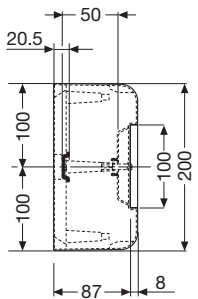

8/12 modules

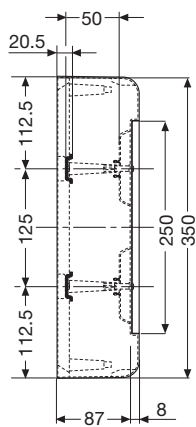

24 modules

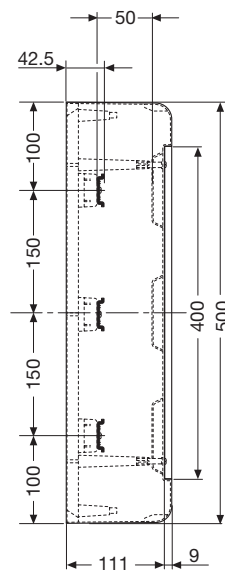

36 modules

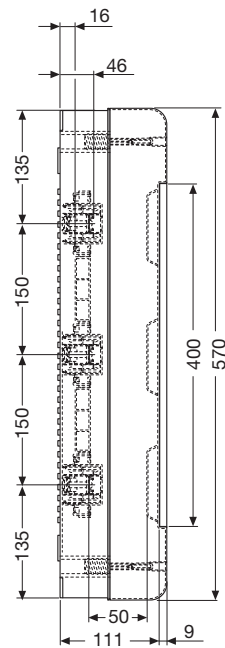

54 modules

VLC00007

# Overall dimensions

## IP 40 Europa Series wall-mounting consumer units

### Drilling sheets

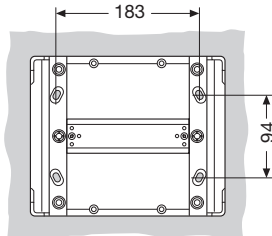

8 modules

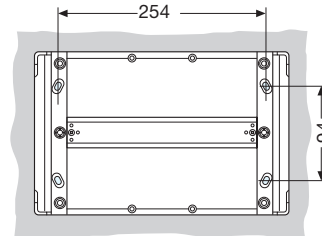

12 modules

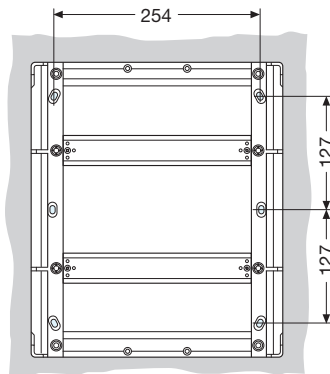

24 modules

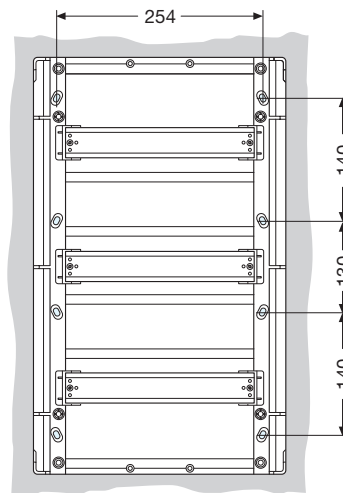

36 modules

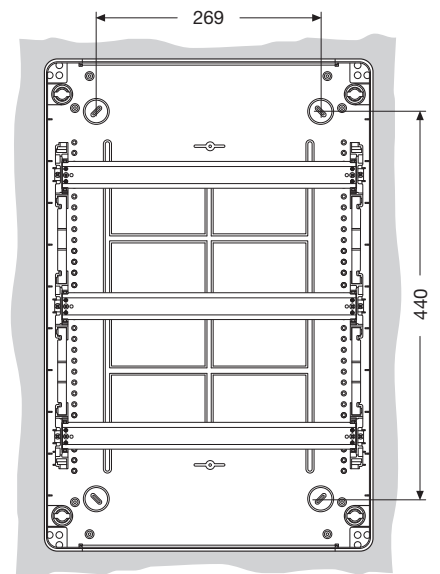

54 modules

modules	code
8 modules	1SL2408A00 - 12 428 - 1SL2438A00 - 12 448 - 1SL2458A00 - 12 468 - 1SL2438A06 - 1SL2458A06
12 modules	1SL2412A00 - 12 432 - 1SL2442A00 - 12 452 - 1SL2462A00 - 12 472 - 1SL2442A06 - 1SL2462A06
24 modules	1SL2414A00 - 12 434 - 1SL2444A00 - 12 454 - 1SL2464A00 - 12 474 - 1SL2444A13 - 1SL2464A13
36 modules	1SL2416A00 - 12 436 - 1SL2446A00 - 12 456 - 1SL2466A00 - 12 476 - 1SL2446A14 - 1SL2466A14
54 modules	1SL2417A00 - 12 437 - 1SL2447A00 - 12 457 - 1SL2467A00 - 12 477 - 1SL2447A07 - 1SL2467A07

VL000008

# Overall dimensions

IP 40 Europa Polycarbonate Series wall-mounting consumer units

## Front view

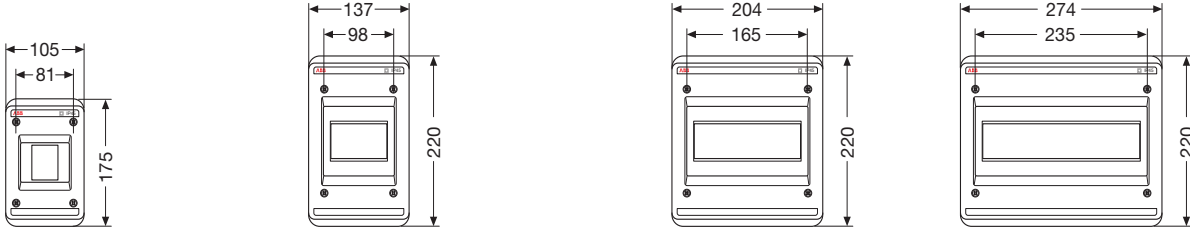

2-4 modules

4 modules

8 modules

12 modules

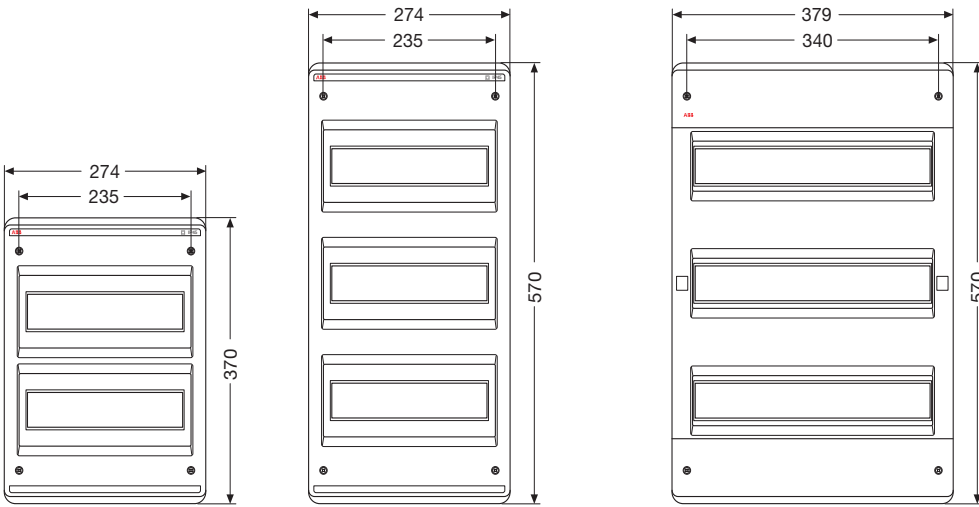

24 modules

36 modules

54 modules

## Side view

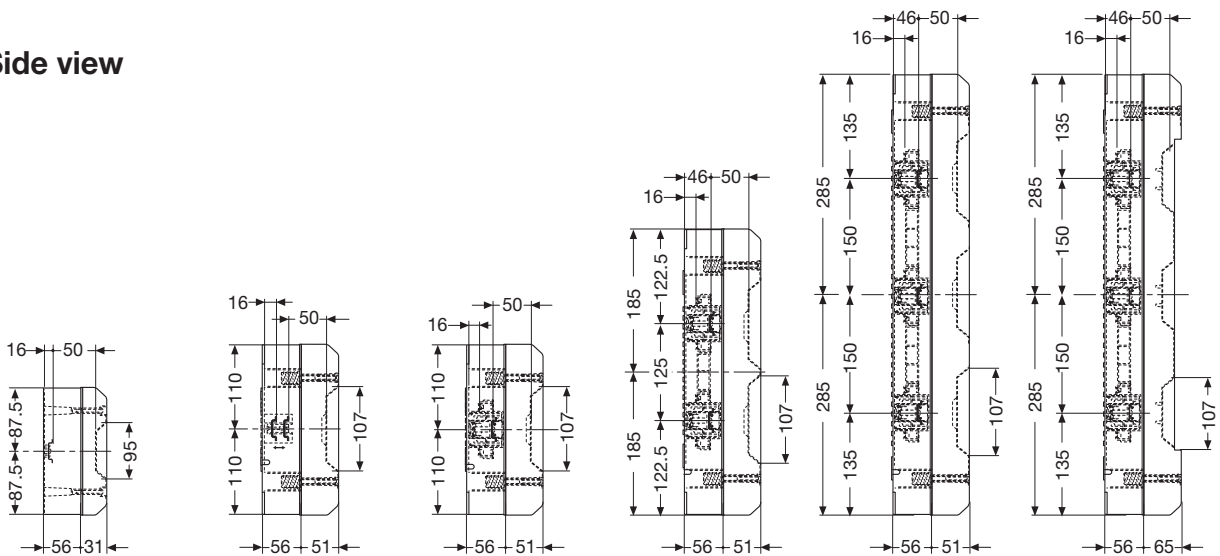

2-4 modules

4 modules

8-12 modules

24 modules

36 modules

54 modules

VLD00009

# Overall dimensions

IP 40 Europa Polycarbonate Series wall-mounting consumer units

## Drilling sheets

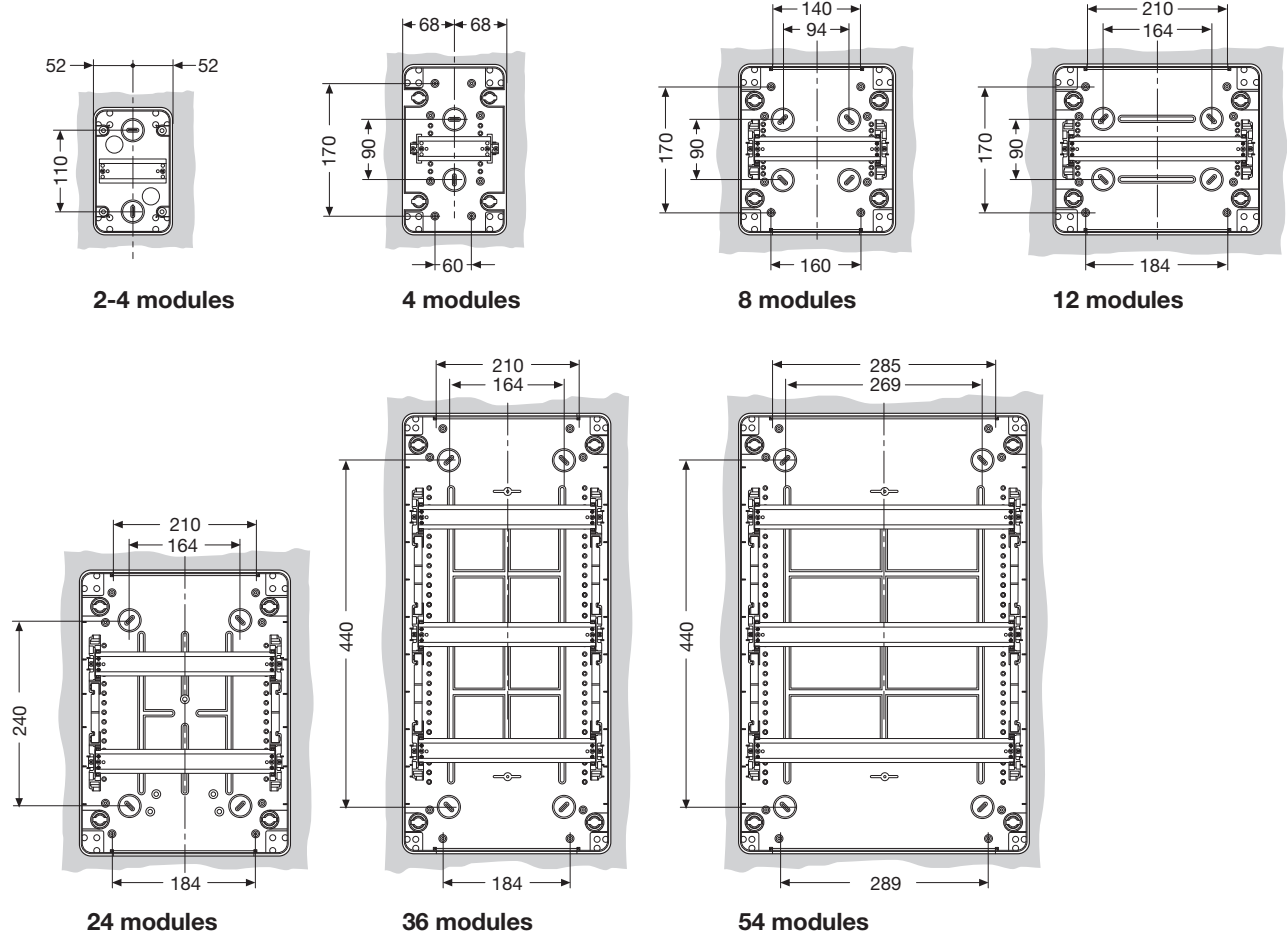

modules	code
2-4 modules	12 702
4 modules	12 704
8 modules	12 708
12 modules	12 712
24 modules	12 714
36 modules	12 716
54 modules	12 718

VAC00010

# Overall dimensions

## IP 40 wall-mounting covers

### Front view

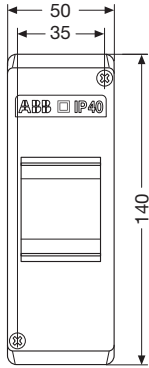

2 modules

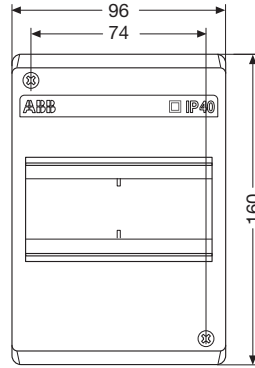

4 modules

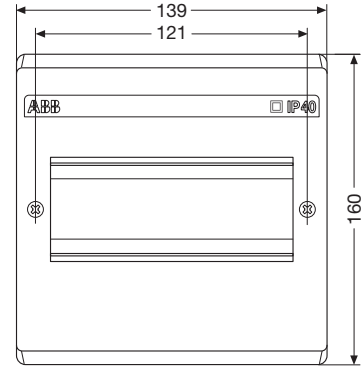

6 modules

### Side view

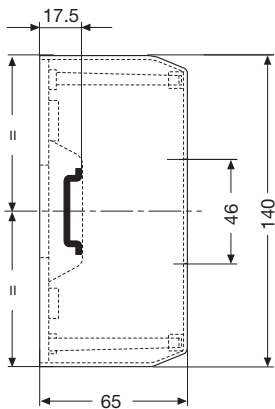

2 modules

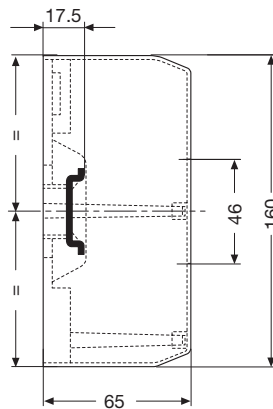

4-6 modules



# Overall dimensions

## IP 40 wall-mounting covers

### Drilling sheets

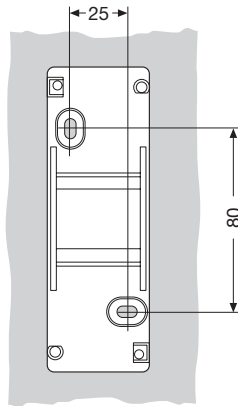

2 modules

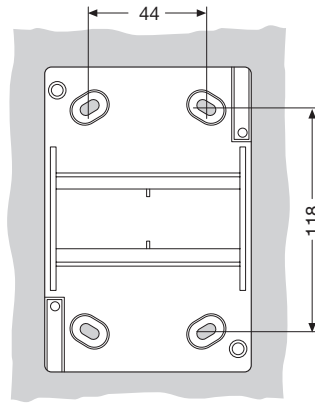

4 modules

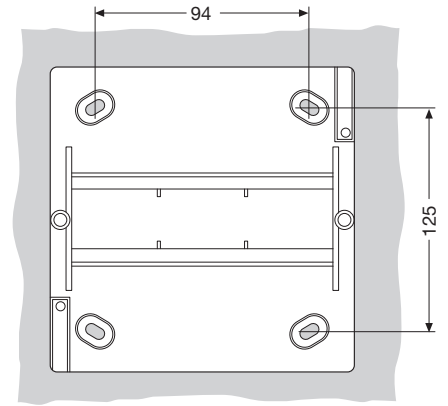

6 modules

modules	code
2 modules	1SL2402A00 – 12 422
4 modules	1SL2404A00 – 12 424
6 modules	1SL2406A00 – 12 426

VLD00012

# Overall dimensions

## IP 55 Europa Series wall-mounting consumer units

### Front view

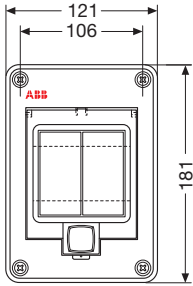

4 modules

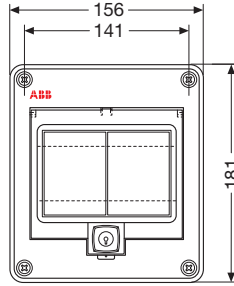

6 modules

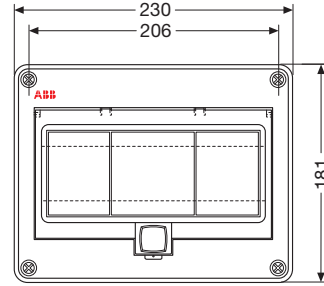

10 modules

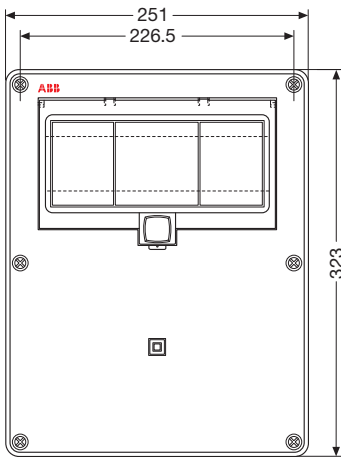

10 special modules

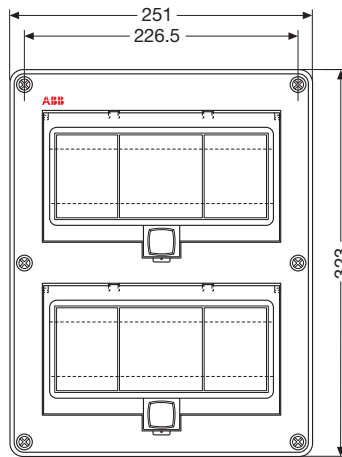

20 modules

### Side view

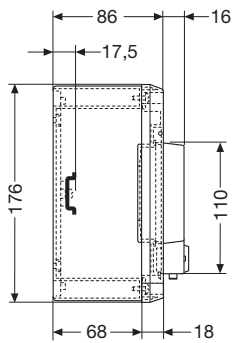

4-6-10 modules

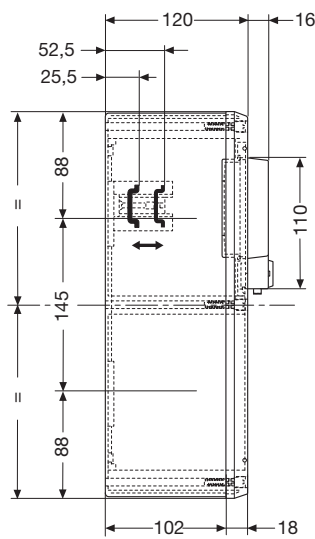

10 modules

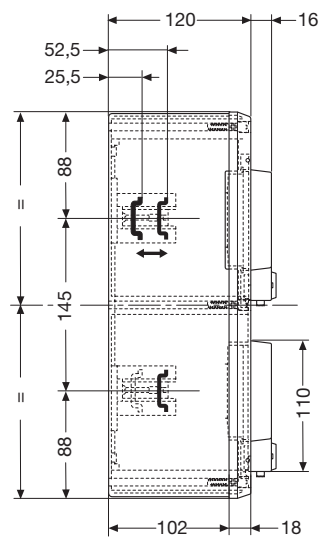

20 modules

# Overall dimensions

## IP 55 Europa Series wall-mounting consumer units

### Drilling sheets

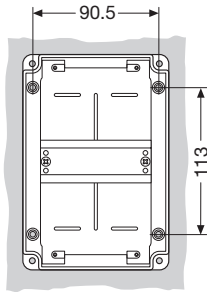

**4 modules**

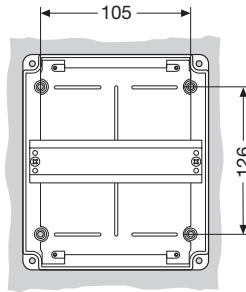

**6 modules**

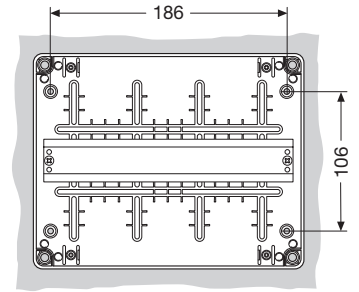

**10 modules**

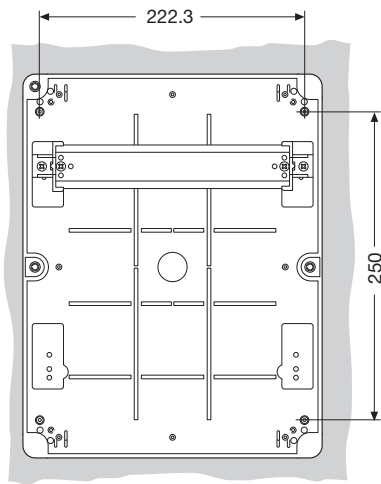

**10 modules**

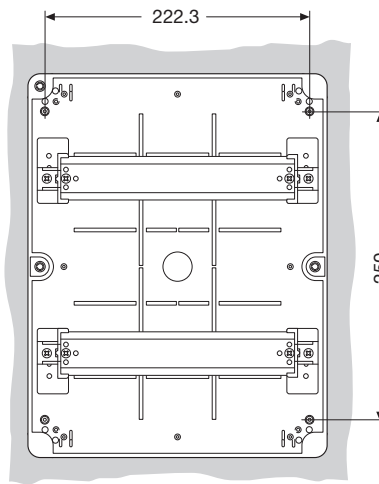

**20 modules**

modules	code
<b>4 modules</b>	<b>12 644</b>
<b>6 modules</b>	<b>12 646</b>
<b>10 modules</b>	<b>12 650 – 12 654</b>
<b>20 modules</b>	<b>12 652</b>

VLC00014

# Overall dimensions

## IP 65 Fly Series wall-mounting consumer units

### Front view

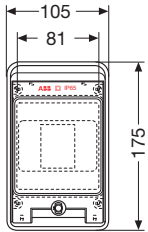

2-4 modules

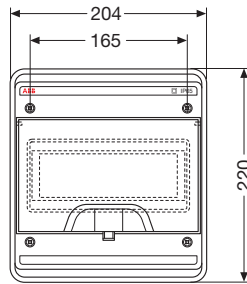

8 modules

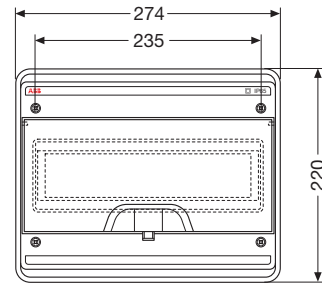

12 modules

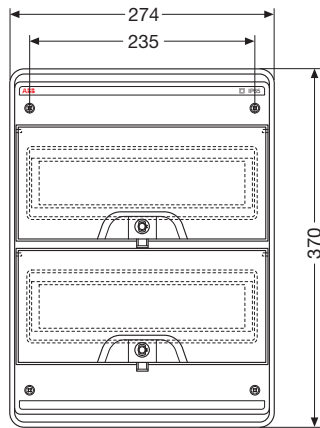

24 modules

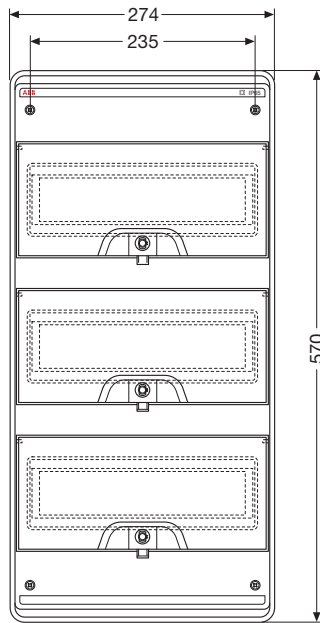

36 modules

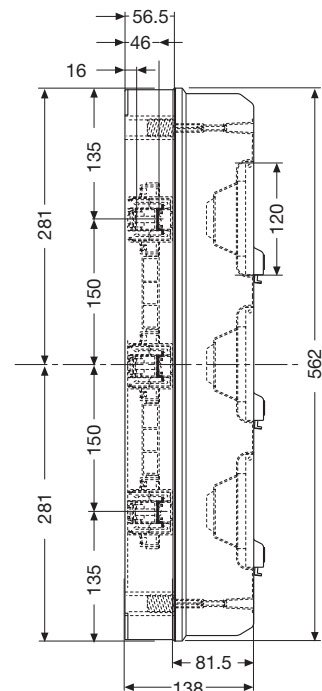

### Side view

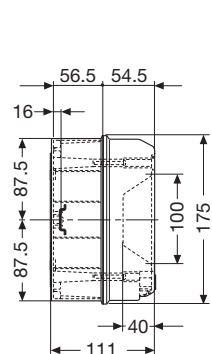

2-4 modules

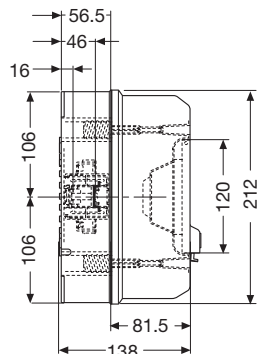

8-12 modules

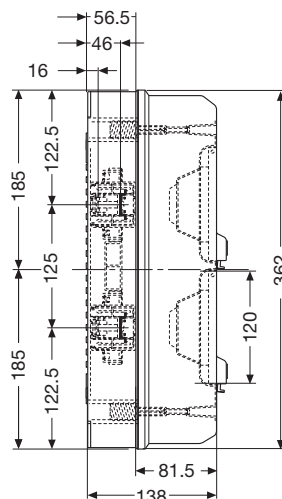

24 modules

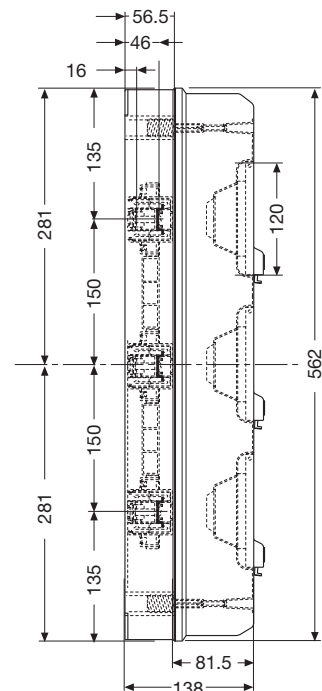

36 modules

VLCO0015

# Overall dimensions

## IP 65 Fly Series wall-mounting consumer units

### Drilling sheets

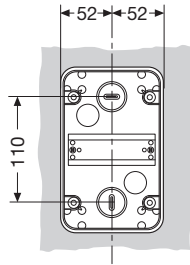

2-4 modules

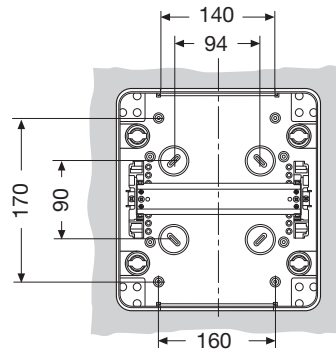

8 modules

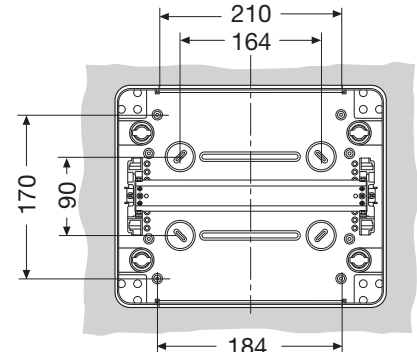

12 modules

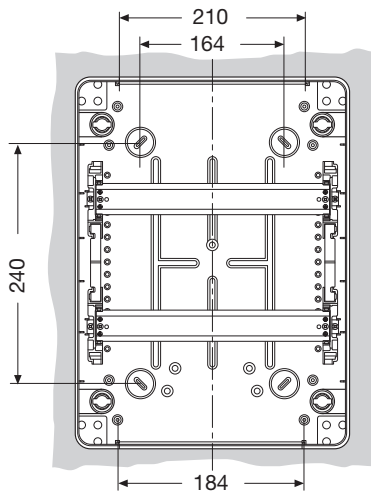

24 modules

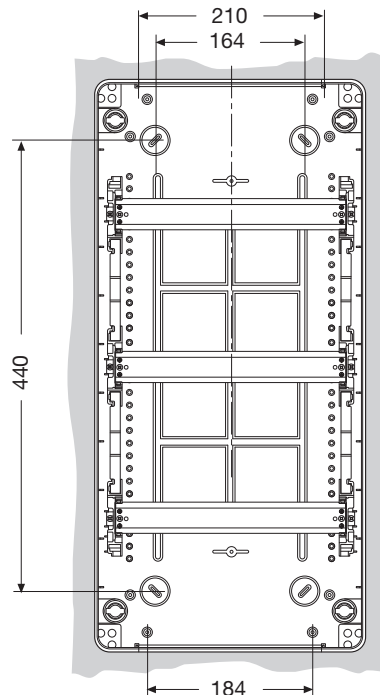

36 modules

modules	code
2-4 modules	12 742 – 12 722
8 modules	12 743
12 modules	12 745
24 modules	12 746
36 modules	12 747

VLC00016

# Overall dimensions

## IP 65 Europa Series wall-mounting consumer units

### Front view

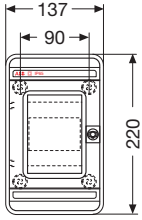

4 modules

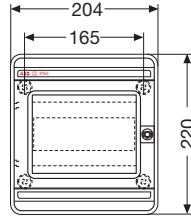

8 modules

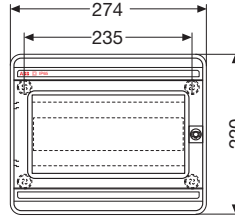

12 modules

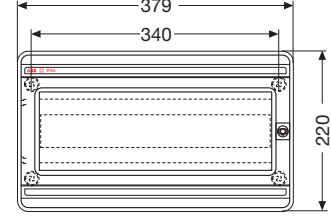

18 modules

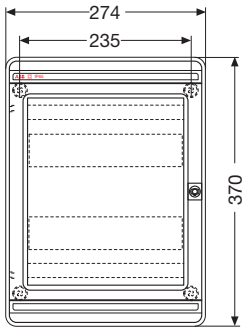

24 modules

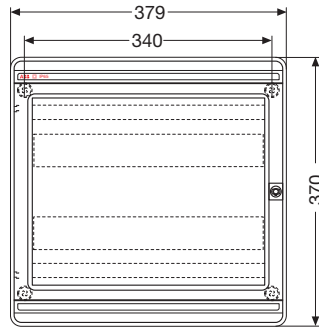

36 modules

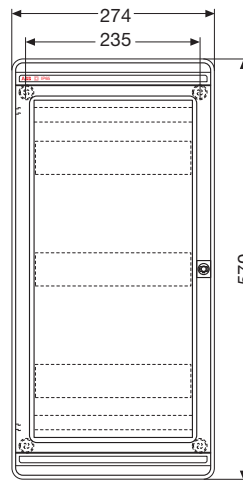

36 modules

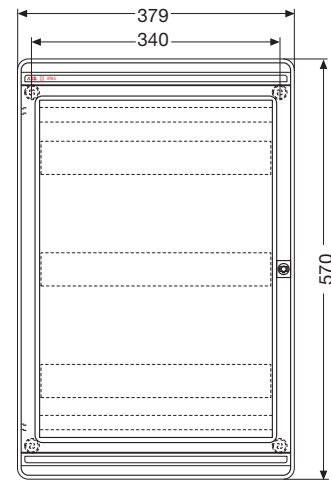

54 modules

### Side view

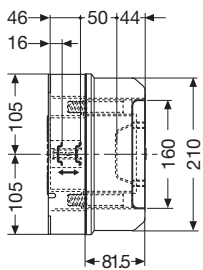

4-8-12 modules

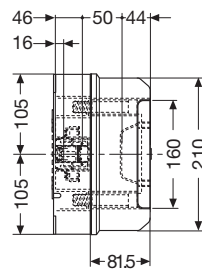

18 modules

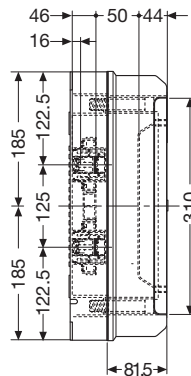

24 modules

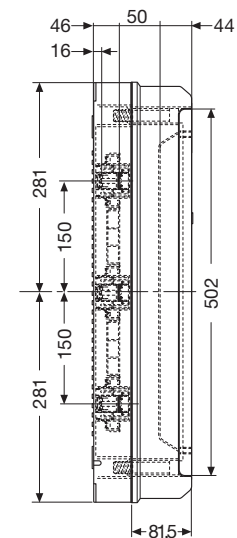

36-54 modules

# Overall dimensions

## IP 65 Europa Series wall-mounting consumer units

### Drilling sheets

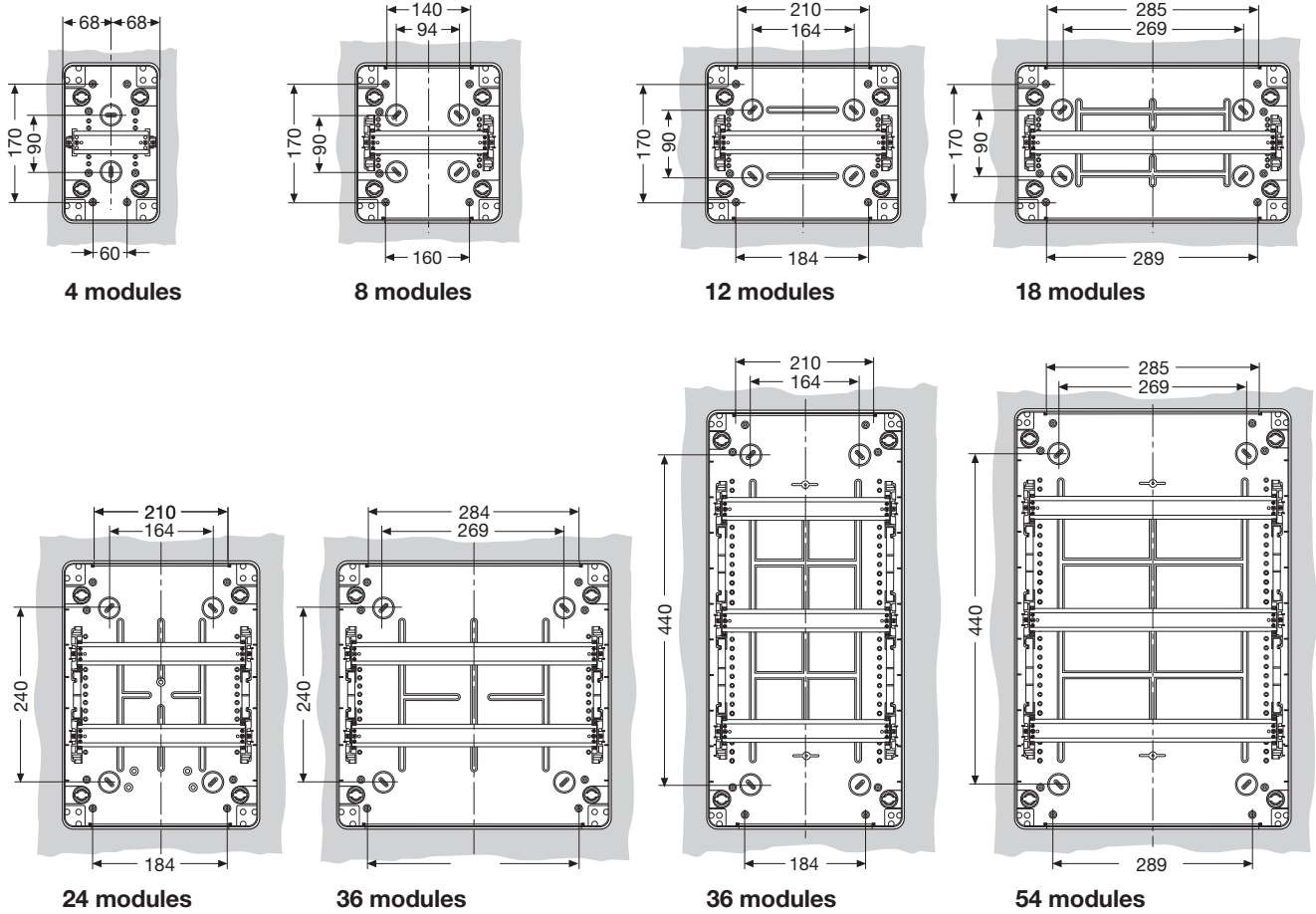

modules	code
4 modules	12 724 – 12 744
8 modules	12 728 – 12 748
12 modules	12 732 – 12 752
18 modules	12 733 – 12 753
24 modules	12 734 – 12 754
36 modules (18x2)	12 735 – 12 755
36 modules (12x3)	12 736 – 12 756
54 modules	12 738 – 12 758

MCC0016



# Overall dimensions

## IP 40 panel fronts

### Front view

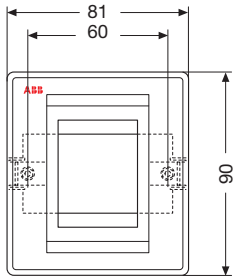

2 modules

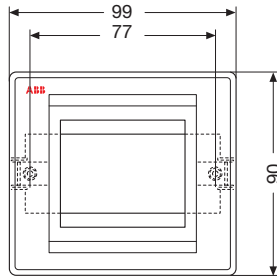

3 modules

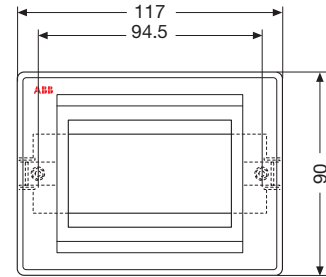

4 modules

### Side view

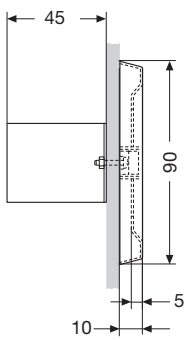

2-3 modules

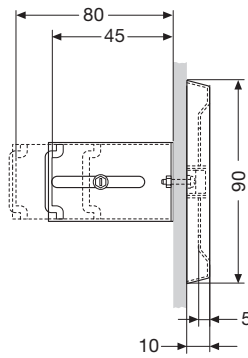

4 modules

### Drilling sheets

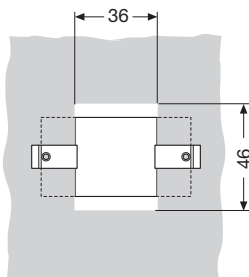

2 modules

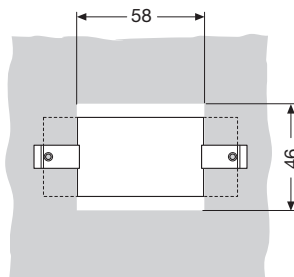

3 modules

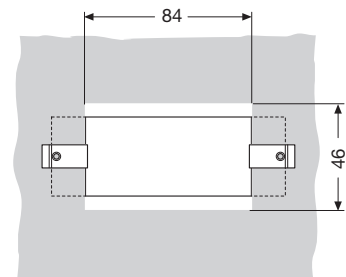

4 modules

modules	code
2 modules	12 362
3 modules	12 363
4 modules	12 364

# Overall dimensions

## IP 55 panel fronts

### Front view

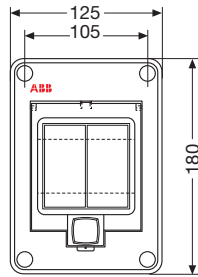

4 modules

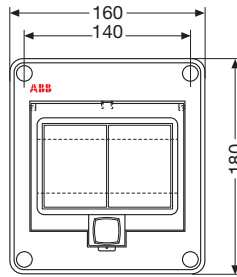

6 modules

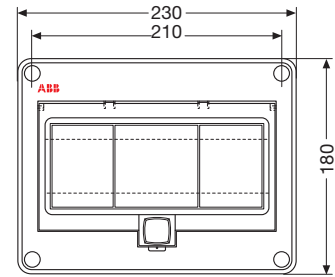

10 modules

### Side view

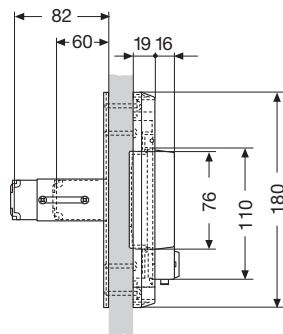

4-6-10 modules

### Drilling sheets

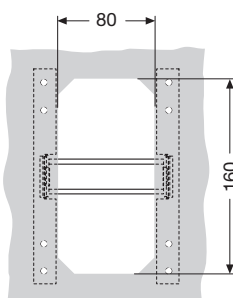

4 modules

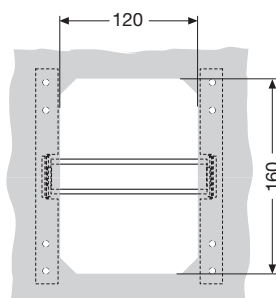

6 modules

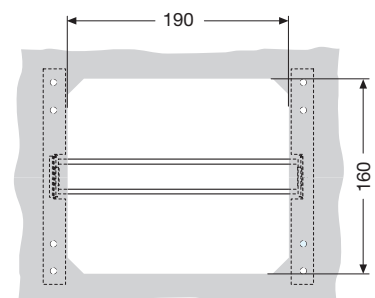

10 modules

modules	code
4 modules	12 658
6 modules	12 659
10 modules	12 660

MLC00020

# Overall dimensions

Livorno Series flush- and wall- mounting emergency consumer units

## Front view

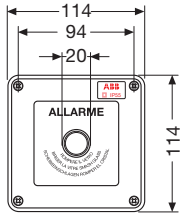

13 180 – 13 183

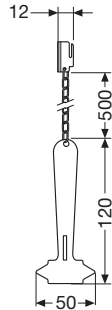

13 186

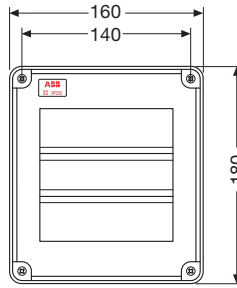

13 161 – 13 165  
13 160 – 13 164

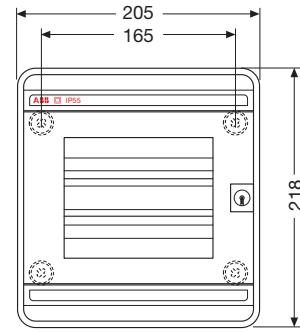

13 171 – 13 175  
13 170 – 13 174

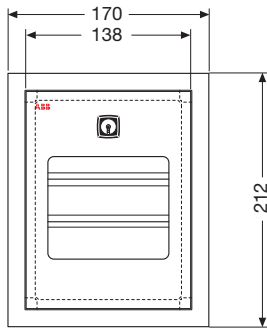

13 141 – 13 151  
13 140 – 13 150

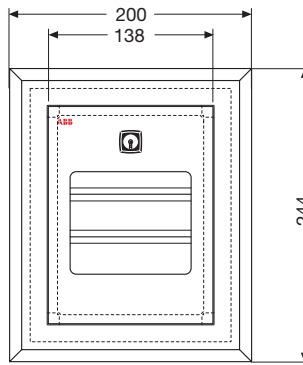

13 144 – 13 154  
13 143 – 13 153

## Side view

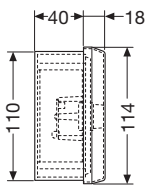

13 180

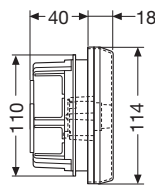

13 183

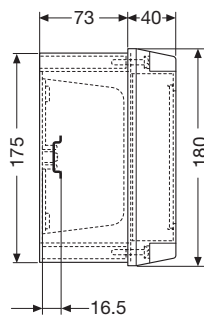

13 161 – 13 165  
13 160 – 13 164

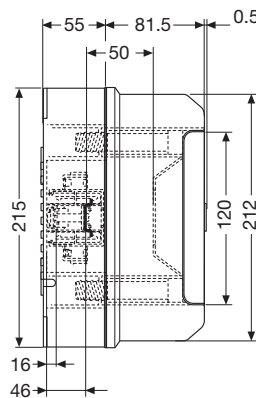

13 171 – 13 175  
13 170 – 13 174

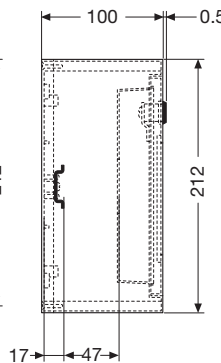

13 141 – 13 151  
13 140 – 13 150

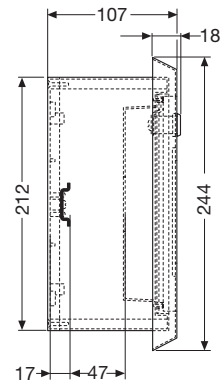

13 144 – 13 154  
13 143 – 13 153

# Overall dimensions

Livorno Series flush- and wall- mounting emergency consumer units

## Drilling sheets

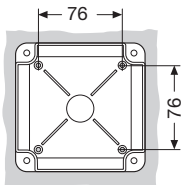

13 180

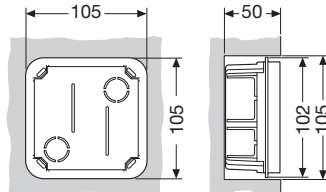

13 183

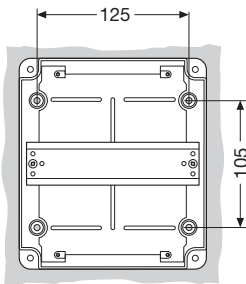

13 161 – 13 165  
13 160 – 13 164

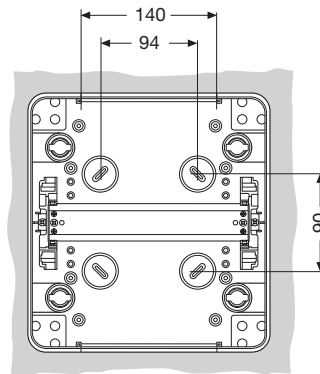

13 171 – 13 175  
13 170 – 13 174

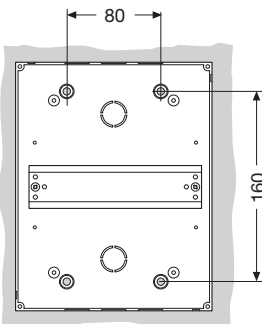

13 141 – 13 151  
13 140 – 13 150

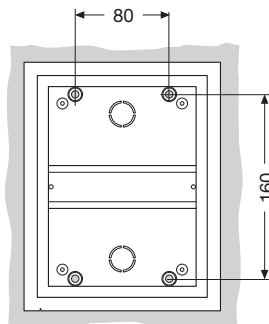

13 144 – 13 154  
13 143 – 13 153

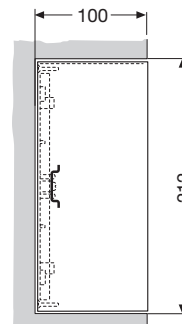

# Overall dimensions

## Europa Series switchboards for industrial applications

### Front view

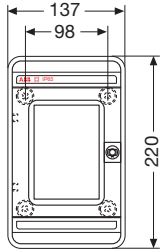

12 764 – 12 784

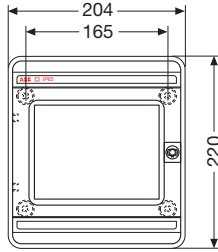

12 768 – 12 788

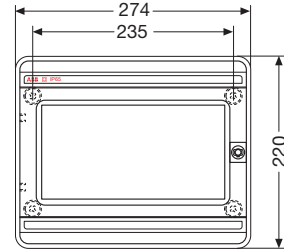

12 772 – 12 792

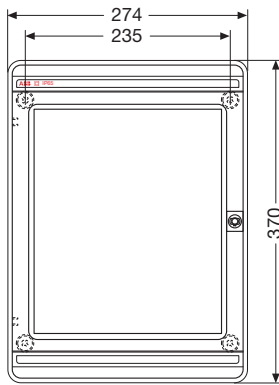

12 774 – 12 794

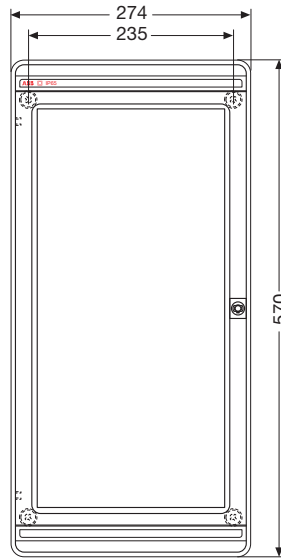

12 776 – 12 796

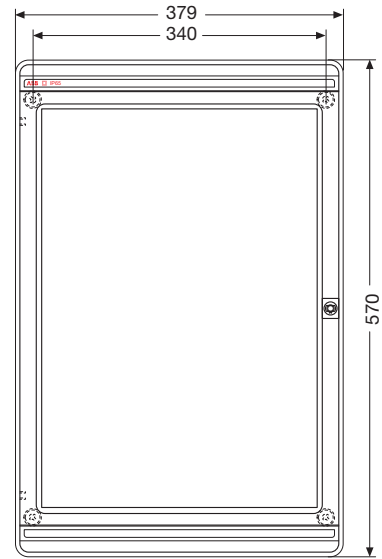

12 778 – 12 798

### Side view

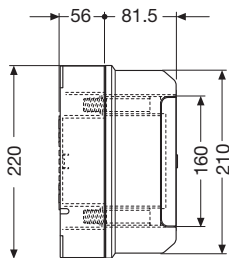

12 768 – 12 788  
12 764 – 12 784  
12 772 – 12 792

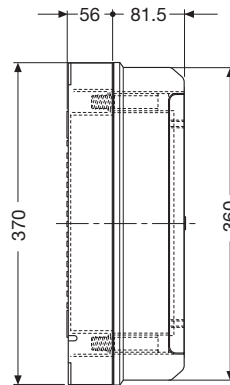

12 776 – 12 796

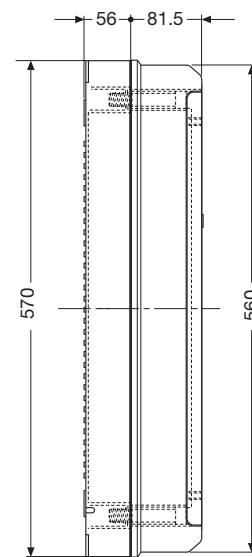

12 778 – 12 798

# Overall dimensions

## Europa Series switchboards for industrial applications

### Drilling sheets

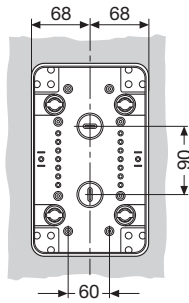

12 764 - 12 784

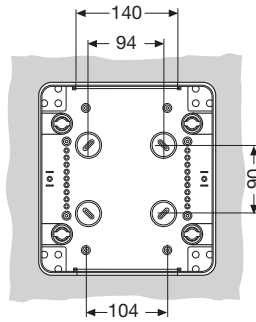

12 768 - 12 788

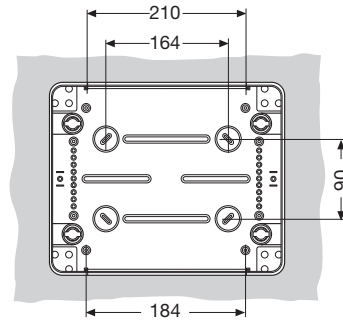

12 772 - 12 792

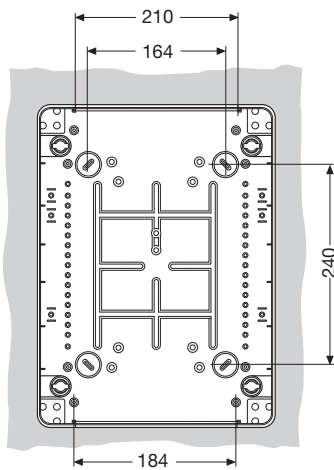

12 774 - 12 794

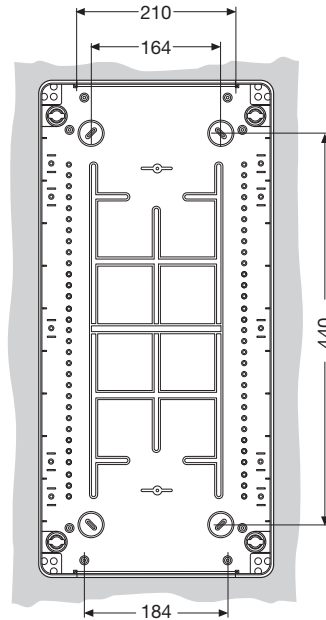

12 776 - 12 796

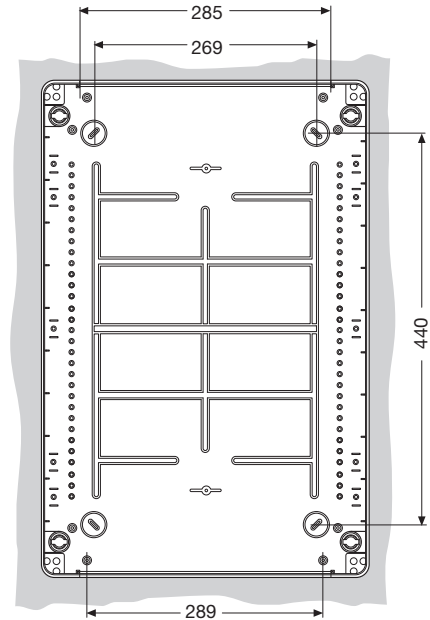

12 778 - 12 798

# Overall dimensions

Switchboards for industrial applications with blank front

## Front view

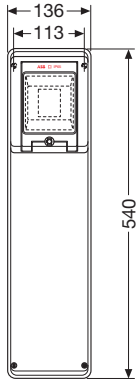

13 200

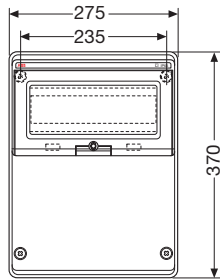

13 204

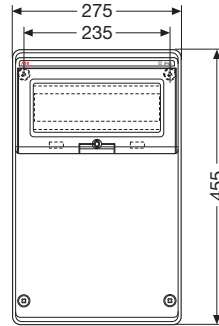

13 205

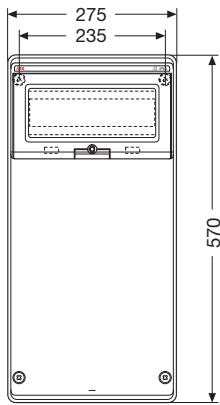

13 206

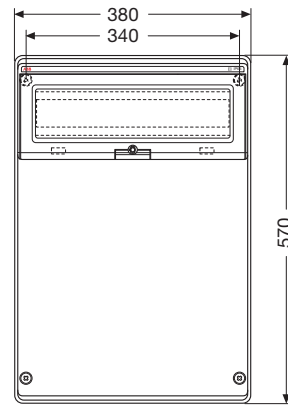

13 208

## Side view

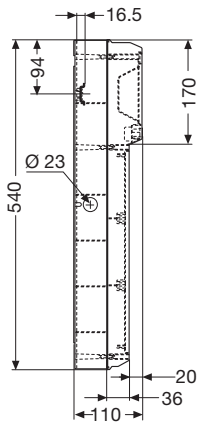

13 200

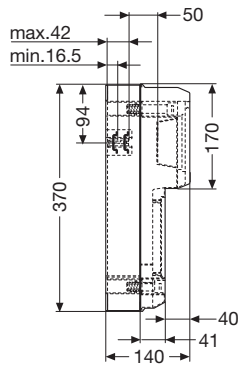

13 204

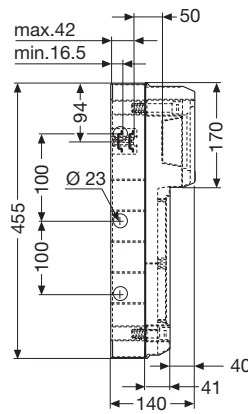

13 205

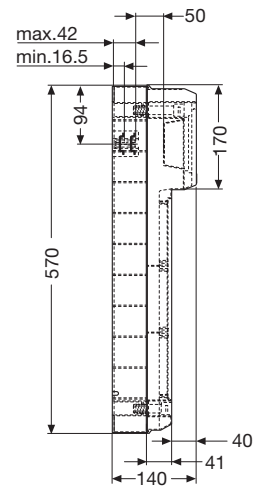

13 206 - 13 208



# Overall dimensions

Switchboards for industrial applications with blank front

## Drilling sheets

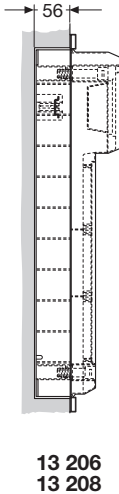
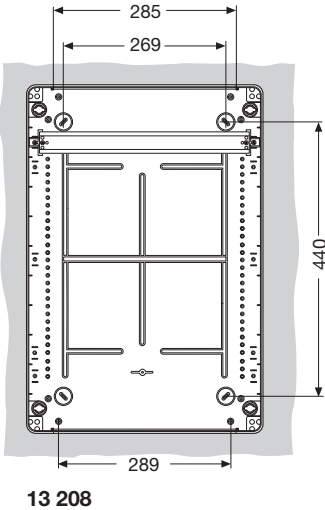
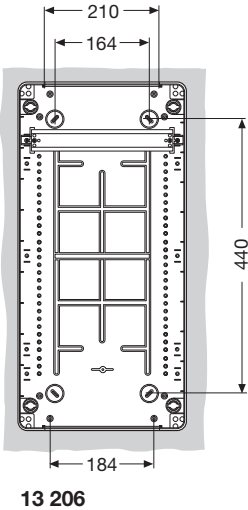
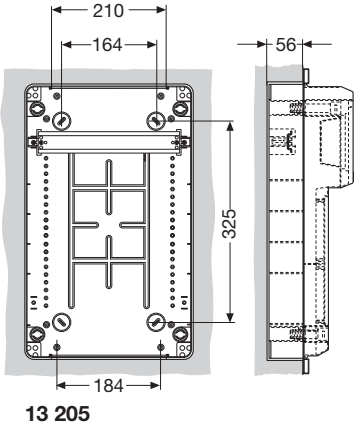
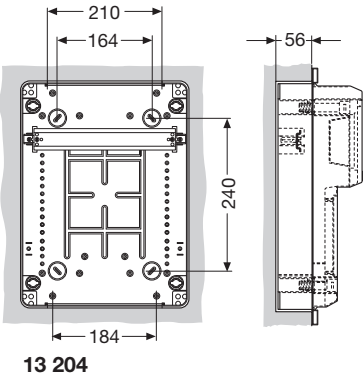
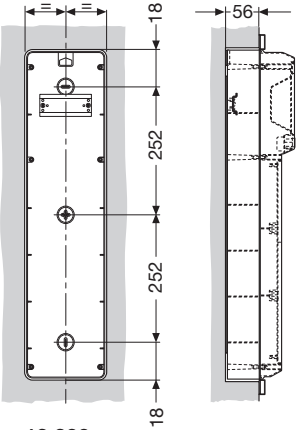

M.CC0206

# Overall dimensions

IP 44 and IP 55 junction boxes in thermoplastic material

## Front view

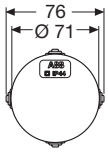

00 800  
1SL0900A00

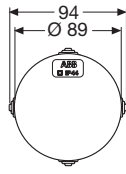

00 802  
1SL0901A00

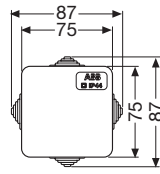

00 808  
1SL0902A00

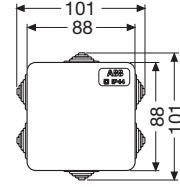

00 810  
1SL0903A00

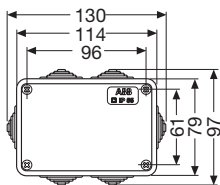

00 820 - 00 850  
1SL0820A00 - 1SL0850A00  
1SL0905A00 - 1SL0909A00  
1SL0920A00 - 1SL0950A00

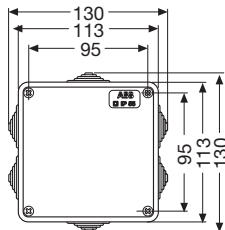

00 816 - 00 821  
00 846 - 00 851  
1SL0816A00 - 1SL0821A00  
1SL0846A00 - 1SL0851A00  
1SL0904A00 - 1SL0906A00  
1SL0908A00 - 1SL0910A00  
1SL0916A00 - 1SL0921A00  
1SL0946A00 - 1SL0951A00

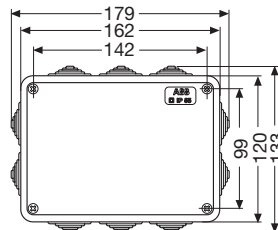

00 822 - 00852 - 00 872  
1SL0822A00 - 1SL0852A00  
1SL0872A00 - 1SL0907A00  
1SL0911A00 - 1SL0912A00  
1SL0922A00 - 1SL0985A00  
1SL0972A00

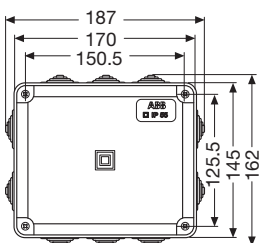

1SL0830A00 - 1SL0824A00  
1SL0874A00 - 1SL0854A00  
1SL0860A00 - 1SL0880A00  
1SL0930A00 - 1SL0924A00  
1SL0974A00 - 1SL0954A00  
1SL0960A00 - 1SL0980A00

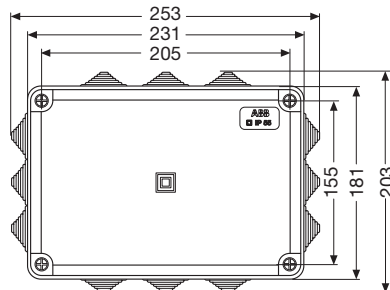

1SL0826A00 - 1SL0832A00  
1SL0876A00 - 1SL0856A00  
1SL0862A00 - 1SL0884A00  
1SL0926A00 - 1SL0932A00  
1SL0976A00 - 1SL0956A00  
1SL0962A00 - 1SL0984A00

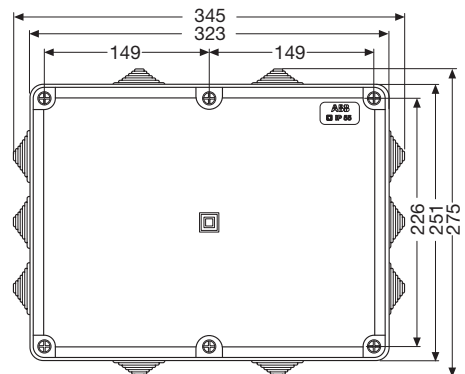

1SL0828A00 - 1SL0834A00  
1SL0878A00 - 1SL0858A00  
1SL0864A00 - 1SL0884A00  
1SL0928A00 - 1SL0934A00  
1SL0978A00 - 1SL0958A00  
1SL0964A00 - 1SL0984A00

10

# Overall dimensions

IP 44 and IP 55 junction boxes in thermoplastic material

## Side view

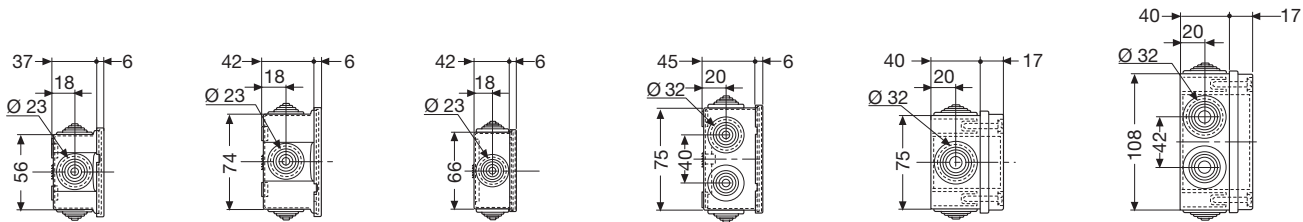

00 800  
1SL0900A00

00 802  
1SL0901A00

00 808  
1SL0902A00

00 810  
1SL0903A00

00 820 - 00 850  
1SL0820A00  
1SL0850A00  
1SL0905A00  
1SL0909A00  
1SL0920A00  
1SL0950A00

00 816 - 00 846  
1SL0816A00  
1SL0846A00  
1SL0904A00  
1SL0908A00  
1SL0916A00  
1SL0946A00

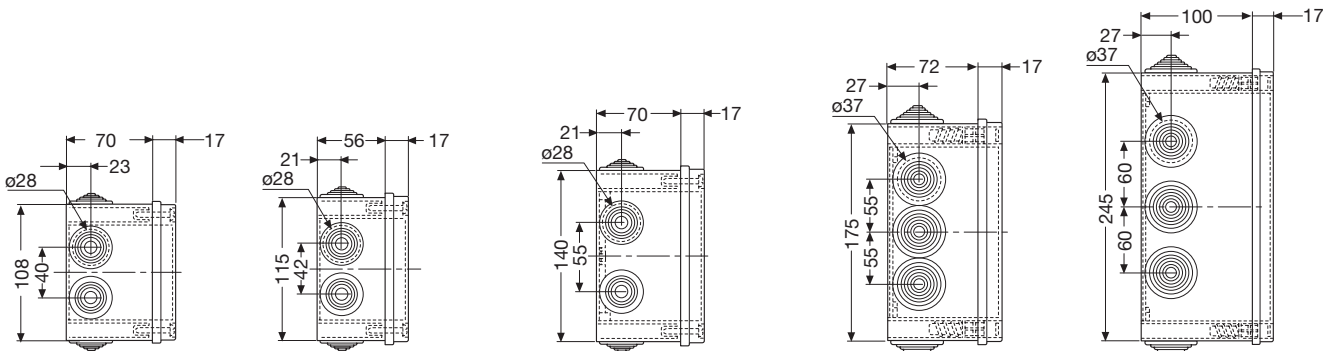

00 821 - 00 851  
1SL0821A00  
1SL0851A00  
1SL0906A00  
1SL0910A00  
1SL0921A00  
1SL0951A00

00 822 - 00 852  
00 872 - 1SL0822A00  
1SL0852A00 - 1SL0872A00  
1SL0907A00 - 1SL0911A00  
1SL0912A00 - 1SL0922A00  
1SL0952A00 - 1SL0972A00

1SL0824A00 - 1SL0854A00  
1SL0874A00 - 1SL0924A00  
1SL0954A00 - 1SL0974A00

1SL0826A00  
1SL0856A00  
1SL0876A00  
1SL0926A00  
1SL0956A00  
1SL0976A00

1SL0828A00  
1SL0858A00  
1SL0878A00  
1SL0928A00  
1SL0958A00  
1SL0978A00

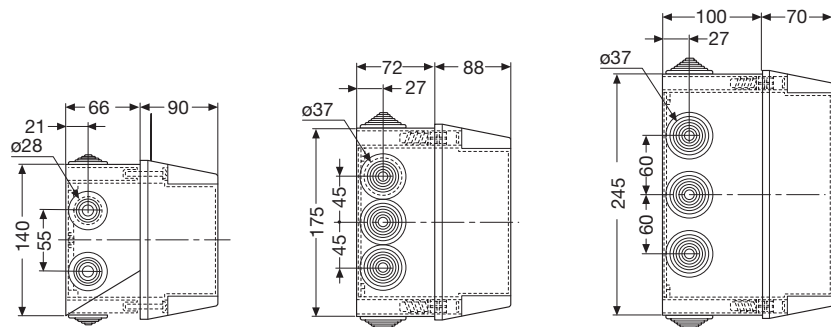

1SL0830A00  
1SL0860A00  
1SL0880A00  
1SL0930A00  
1SL0960A00  
1SL0980A00

1SL0832A00  
1SL0862A00  
1SL0882A00  
1SL0932A00  
1SL0962A00  
1SL0982A00

1SL0834A00  
1SL0864A00  
1SL0884A00  
1SL0934A00  
1SL0964A00  
1SL0984A00

VL000030

# Overall dimensions

IP 44 and IP 55 junction boxes in thermoplastic material

## Drilling sheets and internal dimensions

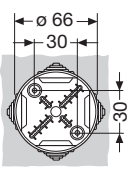

00 800 - 00 581  
1SL0900A00  
1SL0910A00

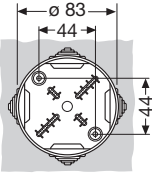

00 802  
1SL0901A00

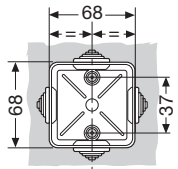

00 808  
1SL0902A00

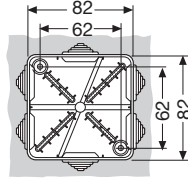

00 810  
1SL0903A00

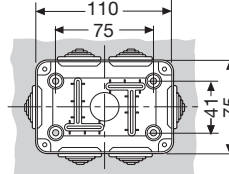

00 820 - 00 850  
1SL0820A00  
1SL0850A00  
1SL0905A00  
1SL0909A00  
1SL0920A00  
1SL0950A00

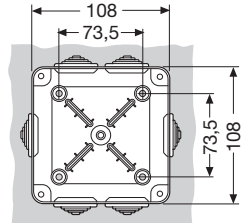

00 816 - 00 846  
1SL0816A00  
1SL0846A00  
1SL0904A00  
1SL0908A00  
1SL0916A00  
1SL0946A00

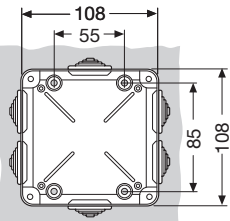

00 821 - 00 851  
1SL0821A00  
1SL0851A00  
1SL0906A00  
1SL0910A00  
1SL0921A00  
1SL0951A00

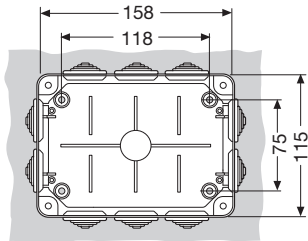

00 822 - 00 852 - 00 872  
1SL0822A00 - 1SL0852A00 - 1SL0872A00  
1SL0907A00 - 1SL0911A00 - 1SL0912A00  
1SL0922A00 - 1SL0952A00 - 1SL0972A00

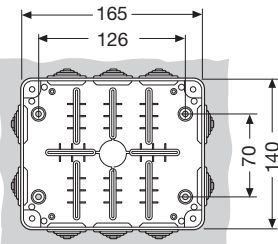

1SL0824A00 - 1SL0830A00  
1SL0874A00 - 1SL0854A00  
1SL0860A00 - 1SL0880A00  
1SL0924A00 - 1SL0930A00  
1SL0974A00 - 1SL0954A00  
1SL0960A00 - 1SL0980A00

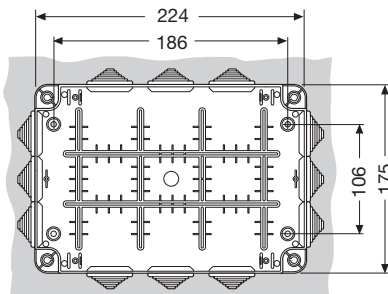

1SL0826A00 - 1SL0832A00  
1SL0876A00 - 1SL0856A00  
1SL0862A00 - 1SL0884A00  
1SL0926A00 - 1SL0932A00  
1SL0976A00 - 1SL0956A00  
1SL0962A00 - 1SL0984A00

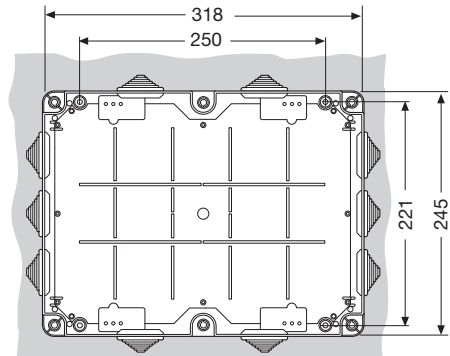

1SL0828A00 - 1SL0834A00  
1SL0878A00 - 1SL0858A00  
1SL0864A00 - 1SL0884A00  
1SL0928A00 - 1SL0934A00  
1SL0978A00 - 1SL0958A00  
1SL0964A00 - 1SL0984A00

# Overall dimensions

## IP 65 junction boxes in polycarbonate

### Front view

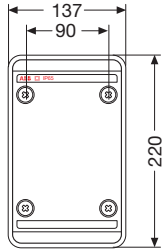

12 804

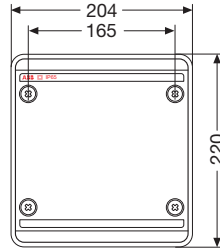

12 808

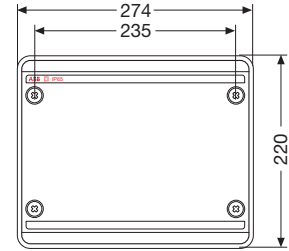

12 812

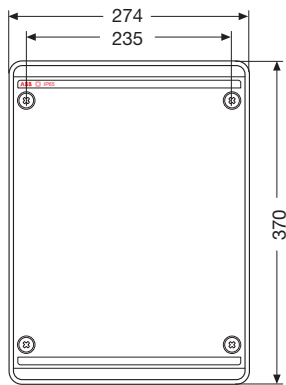

12 814

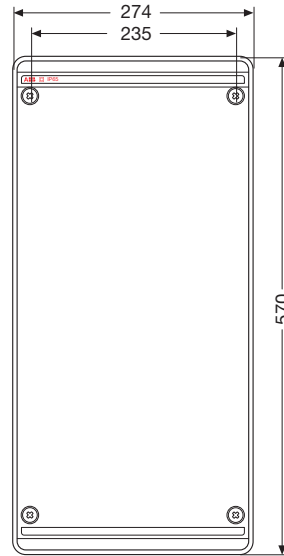

12 816

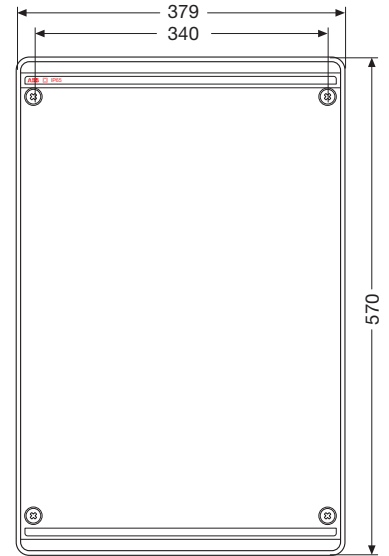

12 818

### Side view

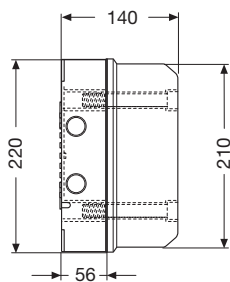

12 804 - 12 808 - 12 812

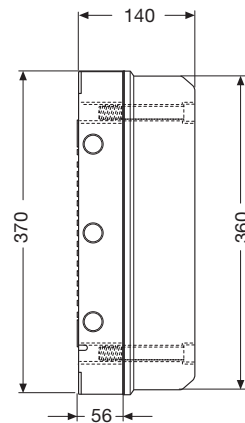

12 814

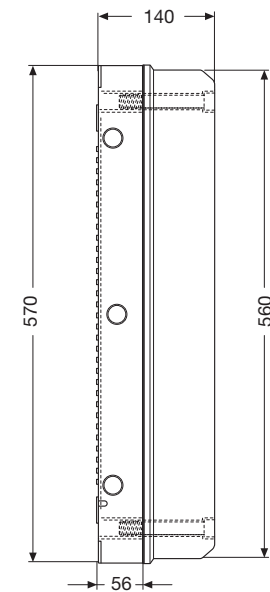

12 816 - 12 818

MCO0031

# Overall dimensions

## IP 65 junction boxes in polycarbonate

### Drilling sheet

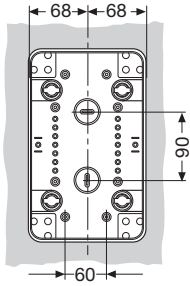

12 804

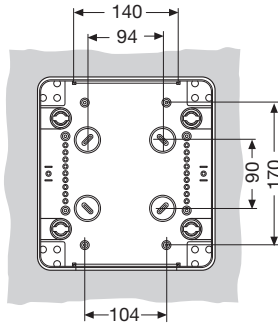

12 808

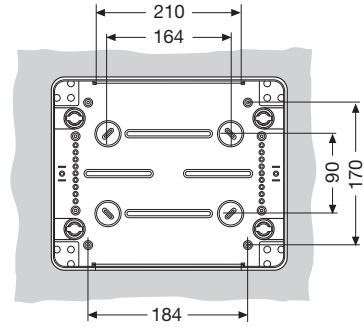

12 812

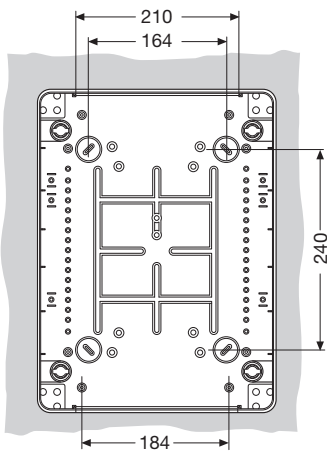

12 814

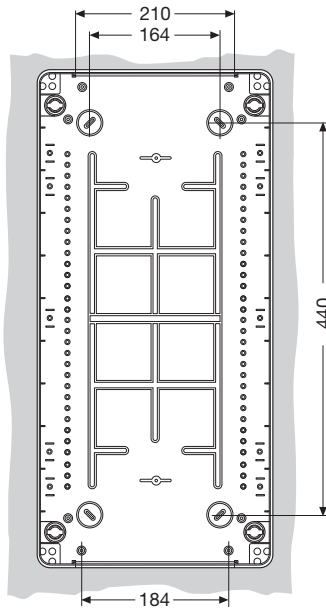

12 816

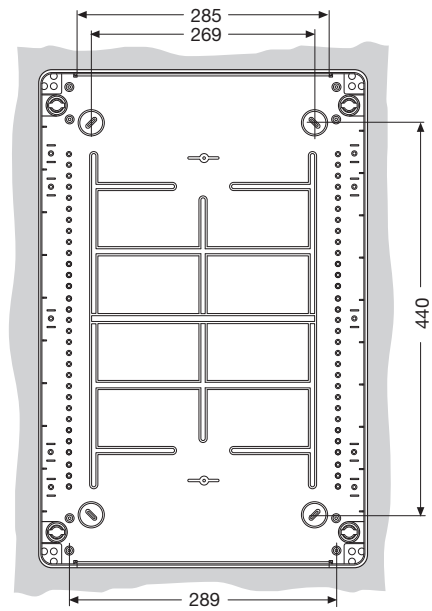

12 818

# Overall dimensions

IP 40 equipment and empty enclosures

## Front view

## Side view

### Boxes for ABB Élos Series

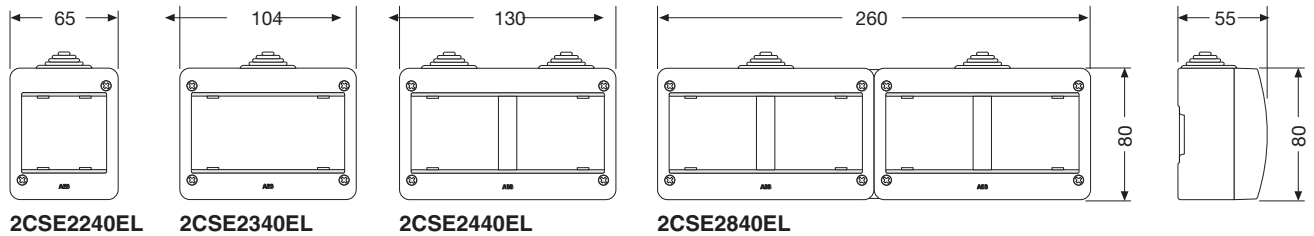

### Boxes for ABB Chiara Series

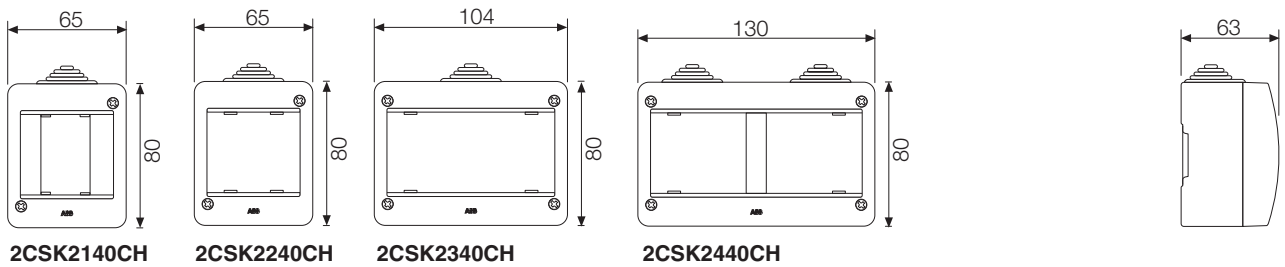



# Overall dimensions

## IP 55 equipment and empty enclosures

### Front view

### Side view

#### Boxes for ABB Élos Series

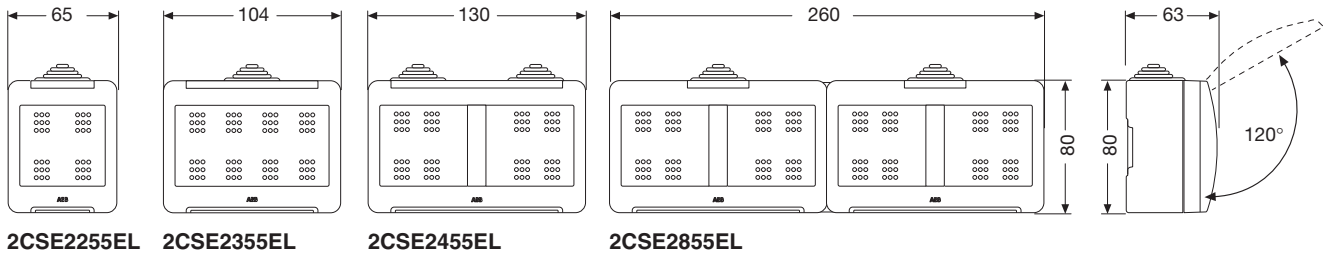

#### Boxes for ABB Chiara Series

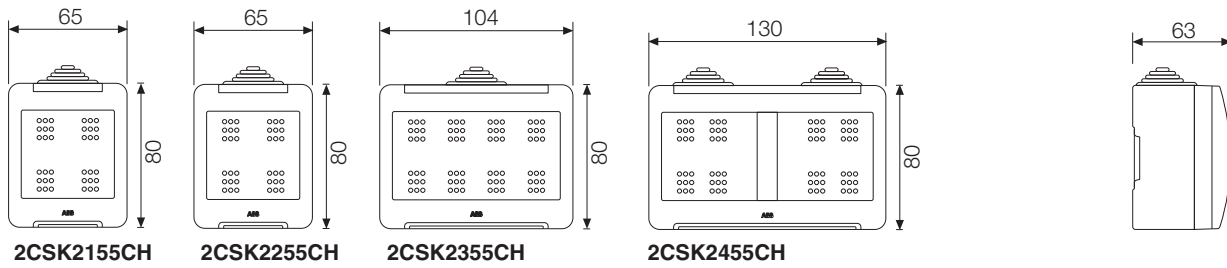

# Overall dimensions

## Various components

### Cable glands PG

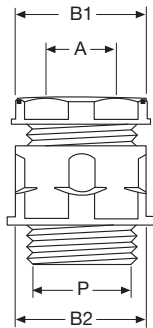

code	P	B1	Ø A
<b>00 931</b>	Pg 9	17	5-8
<b>00 932</b>	Pg 11	19	7-10
<b>00 933</b>	Pg 13.5	21	9-13
<b>00 934</b>	Pg 16	24	13-16
<b>00 935</b>	Pg 21	30	17-20
<b>00 936</b>	Pg 29	40	21-26
<b>00 937</b>	Pg 36	50	30-34
<b>00 938</b>	Pg 42	55	40-43

### Metric glands clamp

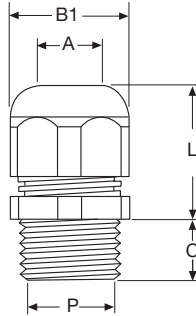

code	P	B1	Ø A	L	C
<b>00 951</b>	M12x1.5	15	3.5-7	18-22	8
<b>00 952</b>	M16x1.5	19	5.5-10	22-27	8
<b>00 953</b>	M20x1.5	25	7-13	24-30	9.5
<b>00 954</b>	M25x1.5	30	10-17	30-41	10
<b>00 955</b>	M32x1.5	36	12-21	33-44	10
<b>00 956*</b>	M40x1.5	46	19-28	36-45	10
<b>00 957*</b>	M50x1.5	55	27-35	43-52	12
<b>00 958*</b>	M63x1.5	66	34-45	45-55	12

### Metric nut

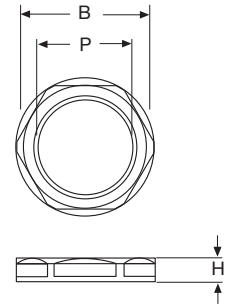

code	P	B
<b>00 961</b>	M12x1.5	17
<b>00 962</b>	M16x1.5	22
<b>00 963</b>	M20x1.5	27
<b>00 964</b>	M25x1.5	32
<b>00 965</b>	M32x1.5	41
<b>00 966*</b>	M40x1.5	50
<b>00 967*</b>	M50x1.5	60
<b>00 968*</b>	M63x1.5	75

### Cable clamps

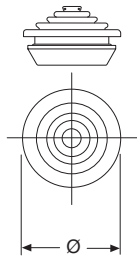

code	Ø
<b>00 908</b>	20
<b>00 910</b>	25
<b>00 912</b>	32

# Overall dimensions

## Enclosures and boxes for light prefabrication

### Junction box

Wiring accessories box Ø 60 mm

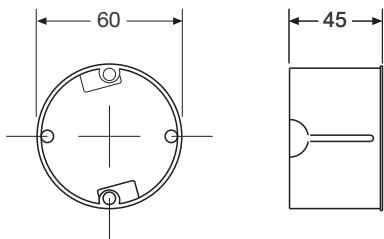

code  
**10 801**

Wiring accessories and junction box Ø 60 mm

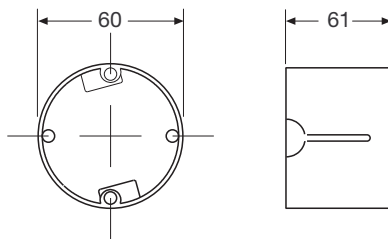

code  
**10 802**

Wall light box 65x35 mm

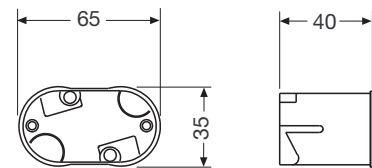

code  
**10 805**

Wiring accessories box Ø 60 mm

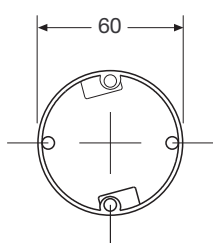

code  
**10 807**

Increased junction box Ø 74 mm

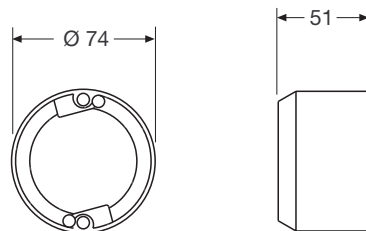

code  
**10 803**

Wiring accessories modular box 100x62 mm

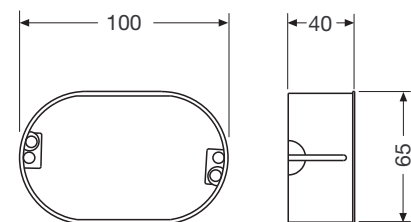

code  
**10 804**

Junction box 100x100 mm

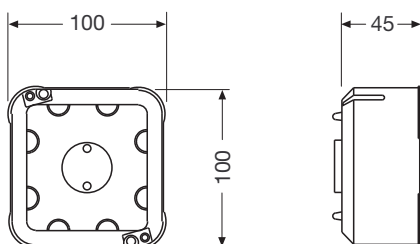

code  
**10 808**

# Overall dimensions

## Enclosures and boxes for light prefabrication

### Boxes for consumer units

Box for consumer unit with 8 modules

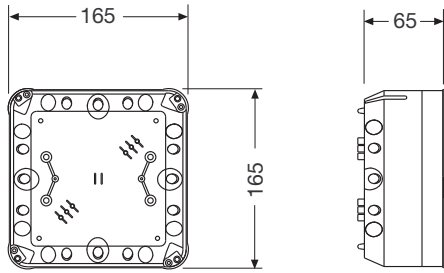

code  
**10 821**

Box for consumer units with 12 modules

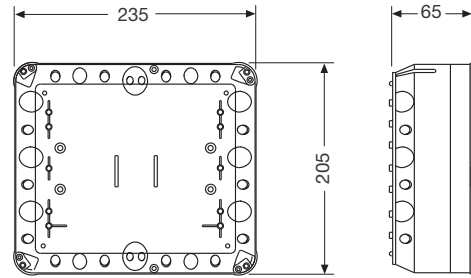

code  
**10 822**

Front for consumer unit with 8 modules

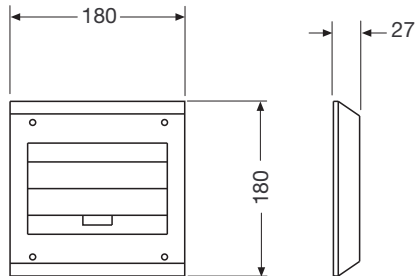

code  
**10 833**

Front for consumer units with 12 modules

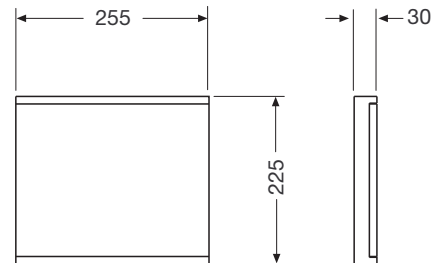

code  
**10 834**

# Overall dimensions

Wiring accessories and junction boxes in thermoplastic material

## Front view

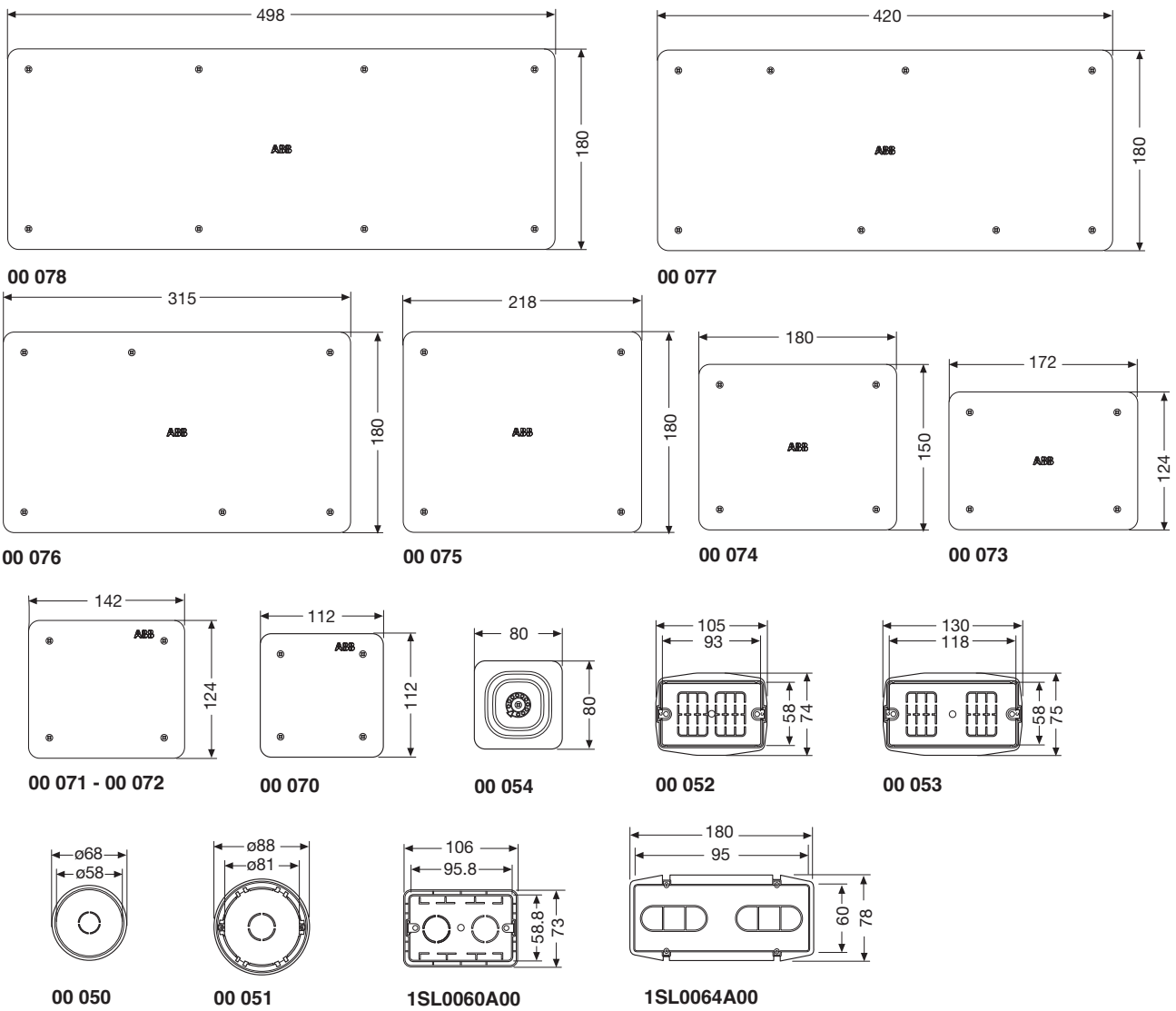

## Side view

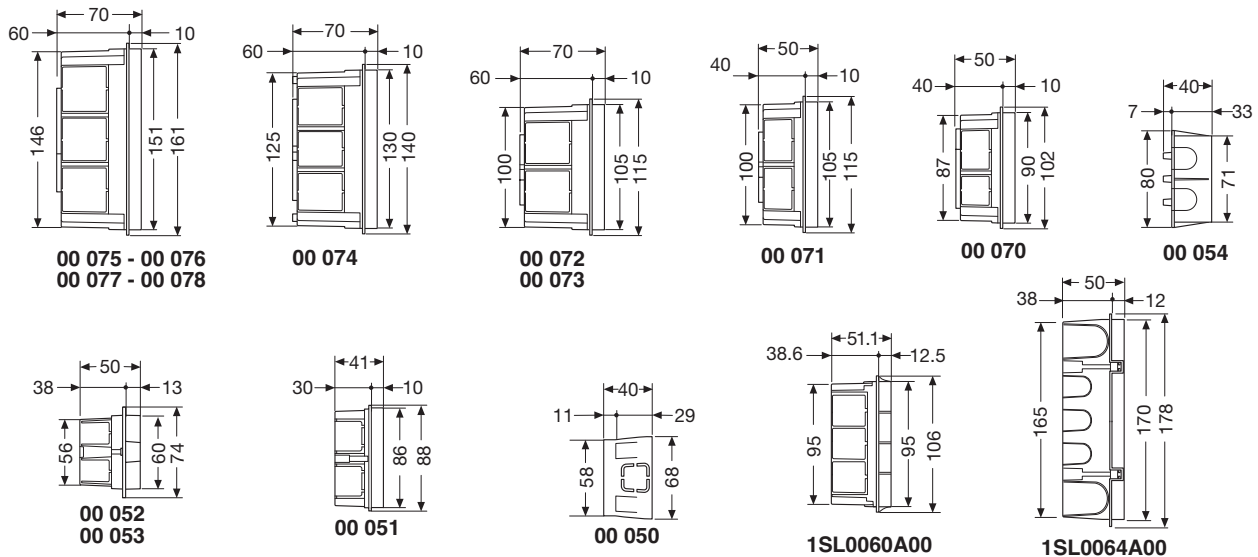

VLCC0037

# Overall dimensions

Wiring accessories and junction boxes in thermoplastic material

## Drilling sheets

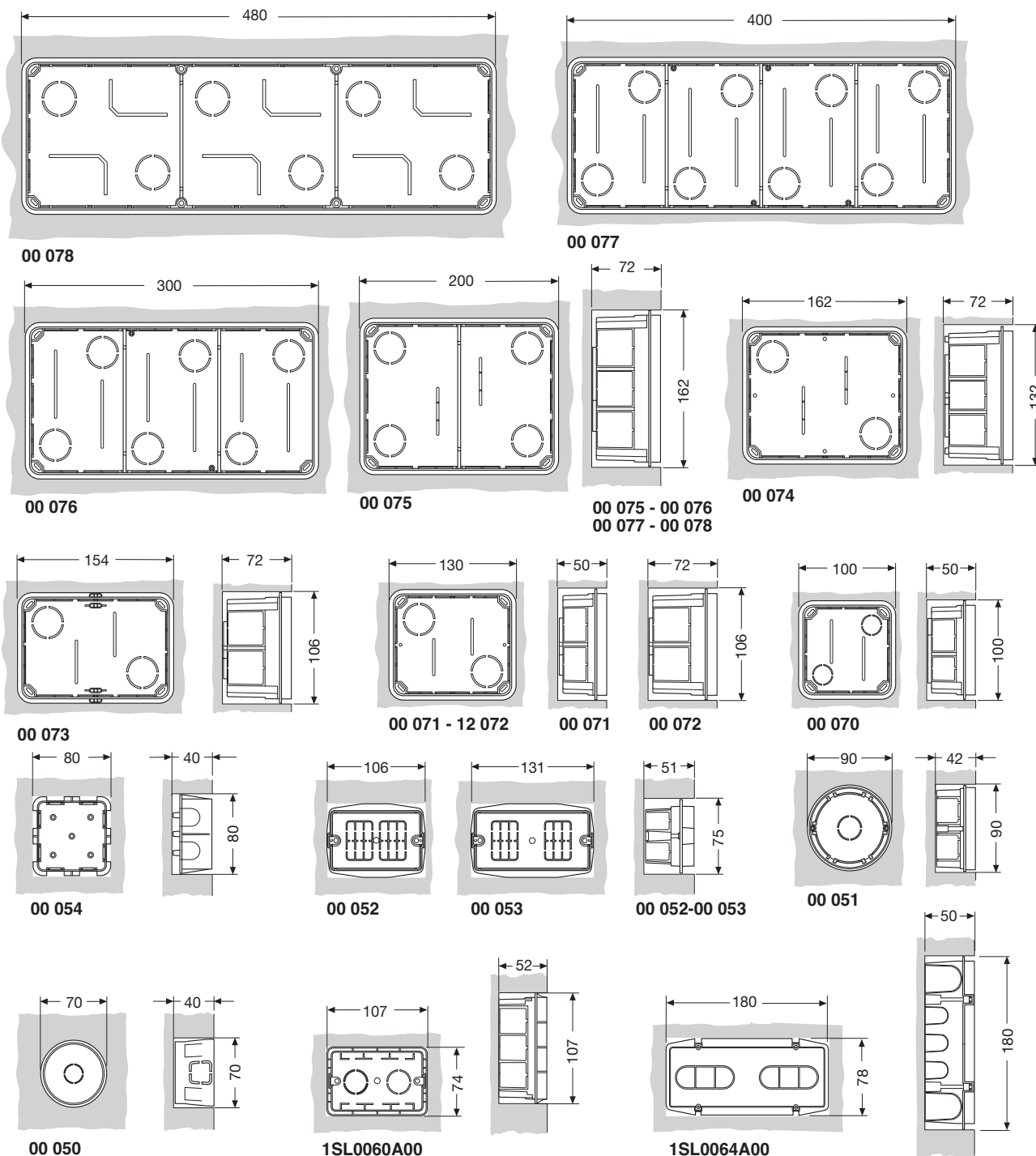

## Covers

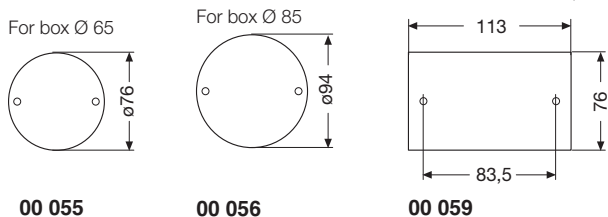

## Spare covers

code	A	B
<b>00 091</b>	110	110
<b>00 092</b>	140	125
<b>00 093</b>	170	125
<b>00 094</b>	180	150
<b>00 095</b>	220	182
<b>00 096</b>	320	182
<b>00 097</b>	425	182
<b>00 098</b>	500	182

# Overall dimensions

## Installation material

### Metal rails

#### Top hat section rail TH 35-7.5

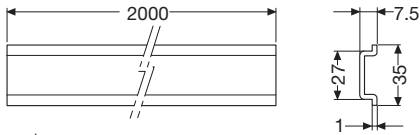

code  
**12 839**

#### Top hat section rail TH 35-15

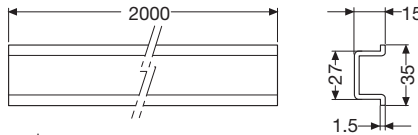

code  
**12 840**

#### "G" section rail G 32

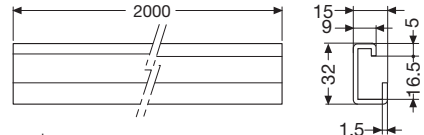

code  
**12 841**

#### Top hat section rail TH 35-7.5 with holes

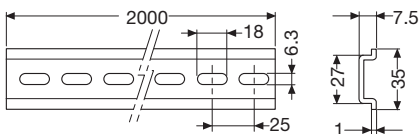

code  
**12 849**

#### Top hat section rail TH 35-15 with holes

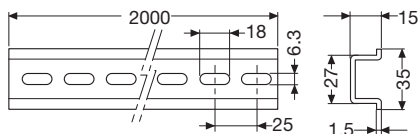

code  
**12 850**

#### "G" section rail G 32 with holes

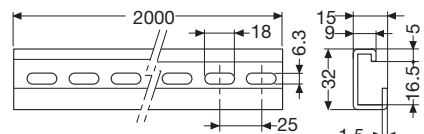

code  
**12 853**

### Supporting bracket for metal rails

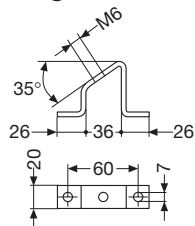

code  
**12 892**

### Plastic base for wiring ducts

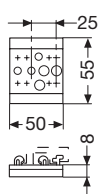

code  
**05 210**

### Universal plastic connector

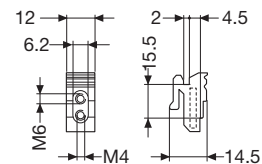

code  
**12 893**

### Universal metal connector

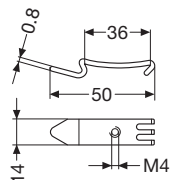

code  
**12 828**

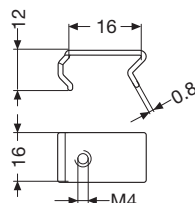

code  
**12 829**

### Polyamide cable-ties

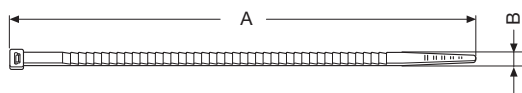

Transparent polyamide	Black polyamide	A	B	Ø tightening	
				min.	max.
18 010	18 110	98	2.5	2	24
18 013	18 113	135	2.5	2	42
18 012	18 112	140	3.6	2.5	36
18 011	18 111	160	2.6	2	35
18 014	18 114	200	3.6	2.5	55
18 015	18 115	178	4.8	3	45
18 017	18 117	290	3.6	2.5	80
18 018	18 118	290	4.8	5	76
18 020	18 120	360	4.8	5	101
18 024	18 124	240	7.8	5	51
18 026	18 126	300	7.8	4	76
18 034	18 134	450	7.8	35	130

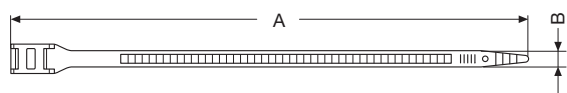

Transparent polyamide	Black polyamide	A	B	Ø tightening	
				min.	max.
18 036	18 136	540	7.8	35	158
18 038	18 138	780	9	32	233
18 028	18 128	365	7.8	8	100

Black polyamide	A	B	Ø tightening	
			min.	max.
18 210	115	6	5	25
18 212	180	6	9	45
18 218	132	9	8	27
18 220	180	9	10	40
18 222	260	9	26	62
18 224	360	9	26	93



# Overall dimensions

## Installation material

### Spirals

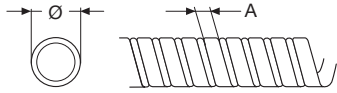

Transparent polyethylene	Self-extinguishing polyethylene	Ø	x	A
18 370	18 380	3		5
18 372	18 382	6		8
18 374	18 384	10		11
18 376	18 386	12		13

### Self-adhesive supports for cable-ties

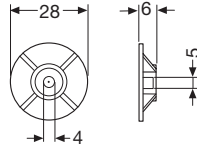

Transparent base	Black base
18 250	18 251

### Pincer for cable-ties

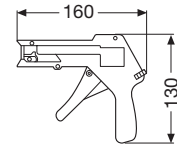

code
18 270

### Screw support for external cable-ties

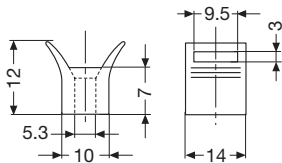

code
18 280

### Pivot support for external cable-ties

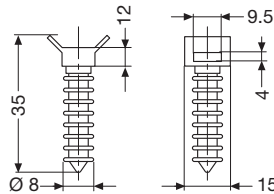

code
18 282

### Pincer for external cable-ties

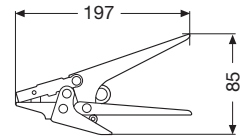

code
18 290

### Wall plugs

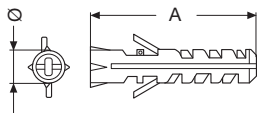

code	Ø	x	A
18 405	5		25
18 406	6		30
18 408	8		40
18 410	10		50

### Wall plugs with screws

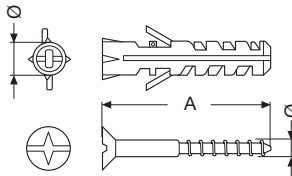

code	wall plug Ø	screw Ø x A
18 415	5	3.5 x 25
18 416	6	4 x 30
18 418	8	5 x 40
18 420	10	6 x 50

### Wall plugs with nail-screw

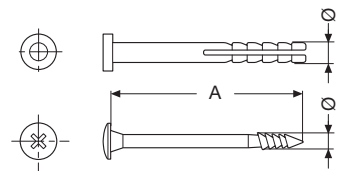

code	wall plug Ø	nail-screw Ø x A
18 430	5	3.5 x 27
18 432	6	4 x 35
18 434	6	4 x 55
18 436	8	5 x 70
18 440	8	5 x 72

VL000046

# Overall dimensions

## Installation material

### Wall plugs with hooks

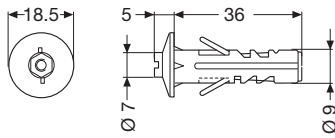

code

18 450 – 18 452 – 18 454 – 18 456 – 18 548

### Stainless-steel wal plugs with hooks

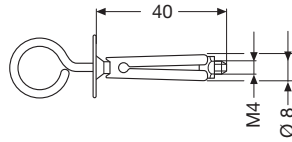

code

18 460 – 18 461 – 18 464 – 18 465 – 18 466

18 467 – 18 470 – 18 471 – 18 472 – 18 473

### Stainless-steel wal plugs with hooks

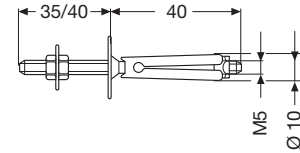

code

18 476 – 18 477 – 17 478 – 18 479

### Stainless-steel wall anchor

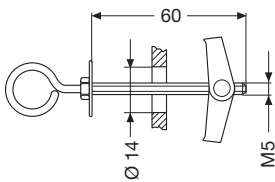

code

18 490 – 18 492 – 17 494 – 18 496

### Screws with stainless-steel wall plugs

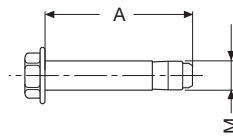

code

	M	x	A
18 486	6		50
18 487	8		55
18 488	10		60
18 489	10		70

### Snap-on conduit holders

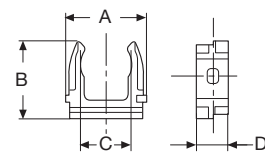

code

	A	B	C	D
05 700	29	26	16	10
05 701	33	28	20	12
05 702	35	32	25	12
05 703	50	42	32	14
05 704	55	50	40	14

### Collar conduit holders

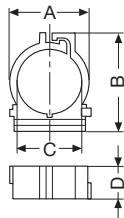

code

	A	B	C	D
05 720	29	26	16	10
05 721	33	28	20	12
05 722	35	32	25	12
05 723	50	42	32	14

### U-bolt conduit holders

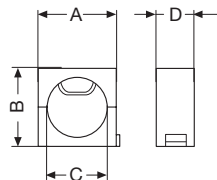

code

	A	B	C	D
05 694	28	29	12-16	17
05 695	35	35	16-25	17
05 696	47	47	25-32	17
05 697	56	56	32-40	17
05 698	70	70	40-50	17

### Strap holders

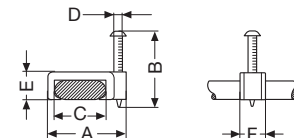

code

	A	B	C	D	E	F
05 760	11	18	6	2	3.5	5.5
05 761	14	18	8	2	3.5	7
05 762	17	18	11	2	5	7.5
05 763	11	18	6	2	3.5	5.5
05 764	14	18	8	2	3.5	7
05 765	17	18	11	2	5	7.5

# Overall dimensions

## Installation material

### Conduit clamps

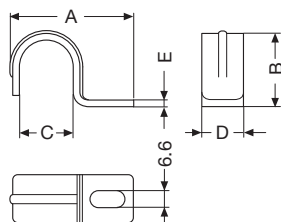

code	A	B	C	D	E
05 730	31	11.5	10	14	1.2
05 731	35	13	12	15	1.5
05 732	35	14	13	15	1.5
05 733	36	16	14	15	1.5
05 734	38	17	16	15	1.5
05 735	42	21	19-20	15	1.5
05 736	44	24	22	16	1.5
05 737	50	27	15-26	16	1.5
05 738	58	27	32	16	1.5
05 739	67	40	38	16	2
05 740	69	42	40	16	2
05 741	82	53	50	17	2

### Conduit clamp collars

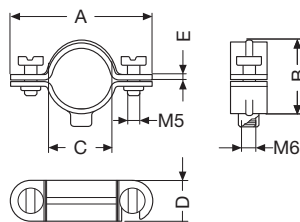

code	A	B	C	D	E
05 745	34	15	10	12	0.8
05 746	37	18	12	12	0.8
05 747	38	19	13	12	0.8
05 748	38	19	14	12	0.8
05 749	42	22	16	13	1.2
05 750	45	26	19-20	13	1.2
05 751	48	29	22	14	1.2
05 752	51	32	25-26	14	1.2
05 753	58	40	32	16	1.5
05 754	67	45	38	16	1.5
05 755	64	48	40	16	1.5
05 756	78	55	50	16	1.5

### Insulated cable clamps

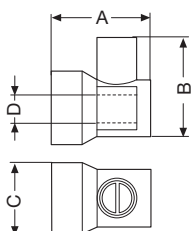

code	A	B	C	D
05 950	19.5	18.5	13.5	4.5
05 951	24	24	16.5	6.5
05 952	29	31	20.5	8

### Cable holders

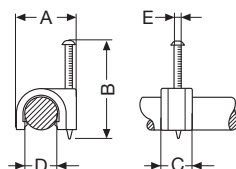

code	A	B	C	D	E
05 770-05 788	9.5	18	6	4	2
05 771-05 789	11.5	18	6	5	2
05 772-05 790	12	18	6	6	2
05 773-05 791	12	24	7.5	7	2
05 774-05 792	14	24	8.5	8	2
05 775-05 793	15	29	9.5	9	2
05 776-05 794	17	29	10	10	2
05 777-05 795	20	29	10	12	2
05 778-05 796	21	29	11	13	2
05 779	22	29	11	14	2
05 780	24	35	12	16	2
05 781	27	45	14	19-20	2.5
05 782	30	45	15	22	2.5
05 783	37	60	20	25-26	2.7
04 784	43	60	25.6	32	2.7

# Overall dimensions

## Accessories

### Module covers

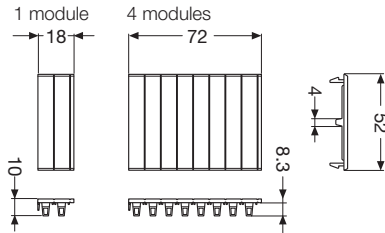

code	No modules
<b>1SL2857A00 – 12 895 – 12 861</b>	1
<b>1SL2859A00 – 12 896 – 12 863 – 12 555</b>	4

### Screw lead sealing accessory

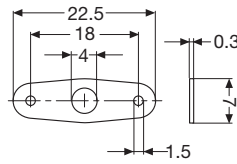

code
<b>12 860</b>

### Brackets

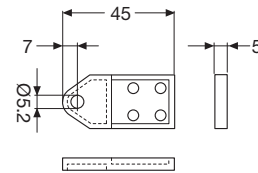

code
<b>12 858</b>

### Semi-flush-mounting frame

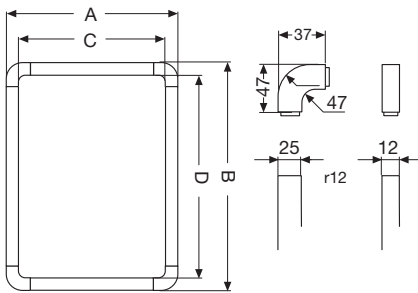

code	A	B	C	D
<b>12 590</b>	187	270	137	220
<b>12 591</b>	254	270	204	220
<b>12 592</b>	325	270	275	220
<b>12 593</b>	325	420	275	370
<b>12 594</b>	325	622	275	572
<b>12 595</b>	430	622	380	572
<b>12 596</b>	430	270	380	220
<b>12 597</b>	430	420	380	370
<b>12 598</b>	136	548	86	498
<b>12 599</b>	275	455	225	405

### Bi-material flange

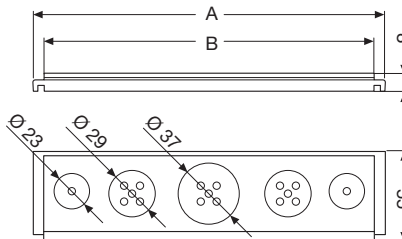

code	A	B
<b>12 600</b>	140	146
<b>12 601</b>	216	210
<b>12 602</b>	292	285

### Rigid flange

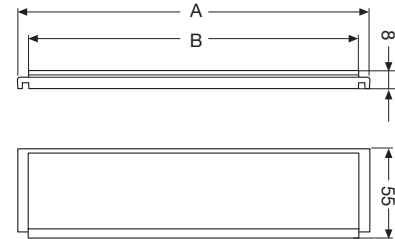

code	A	B
<b>1SL0550A00</b>	140	146
<b>1SL0551A00</b>	216	210
<b>1SL0552 A00</b>	292	285

### Unibox Series coupling accessory

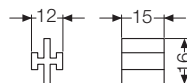

code
<b>12 556</b>

### Unibox Series cable holder

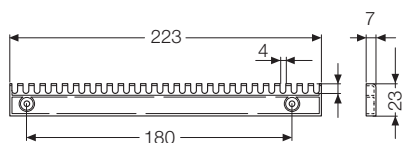

code
<b>12 530</b>

### Plug/box unions element

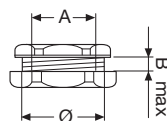

code	Ø	A	B
<b>13 874</b>	23	18	7
<b>13 875</b>	28.5	22	7
<b>13 876</b>	37	30	10

### DIN rails

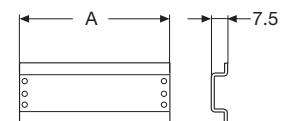

code	A
<b>12 852</b>	86
<b>12 854</b>	164
<b>12 855</b>	224
<b>12 856</b>	330

# Overall dimensions

## Accessories

### Kit for MCBs connectors

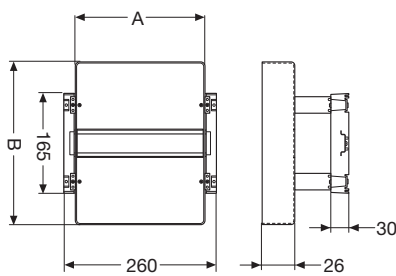

code	A	B
12 820	217	273
12 821	217	474
12 822	321	474

### Fixed counter-doors

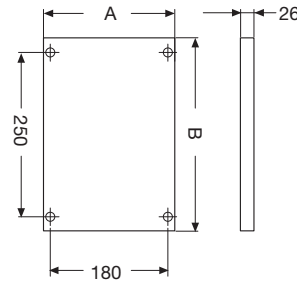

code	A	B
12 825	217	273
12 826	217	474
12 827	827	321

### Insulating material base plates

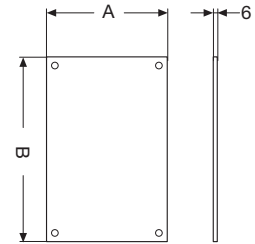

code	A	B
12 832	80	116
12 834	147	116
12 835	217	116
12 836	217	266
12 837	217	466
12 838	322	466

### Metal base plates for IP 65 box

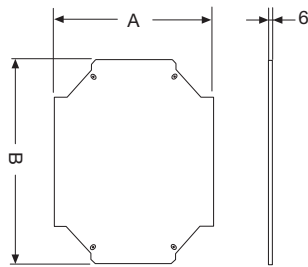

code	A	B
12 842	80	116
12 844	145	116
12 845	215	116
12 846	215	266
12 847	215	466
12 848	320	466

### Metal base plates for IP 55 water-proof box

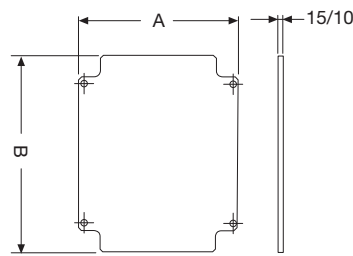

code	A	B
00 900	120	149
00 902	153	200
00 904	222	290

### Conduit clamps-connector box Plastic spacer

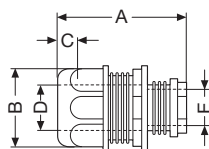

code	A	B	C	D	E
00 430	37	28	4.8	16.5	11.9
00 431	37	33.4	4.9	20.8	15.9
00 432	37.7	38.9	5	25.5	19.8
00 433	46.6	51	5.5	32.1	20.2
00 434	49.6	56.2	5.5	40.4	33.5
00 435	49.9	67.4	5.5	50.5	44

### Plastic spacer

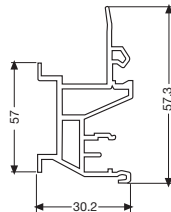

code
12 851

### Universal cutter

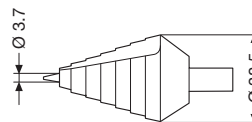

code
12 894

### Module covers

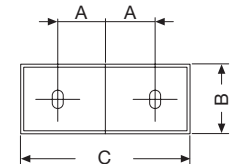

code	A	B	C
12 868	35	36	100.5
12 869	35	36	100.5

V.L000050

# Overall dimensions

## Accessories

### Terminal holders

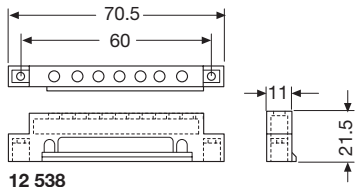

12 538

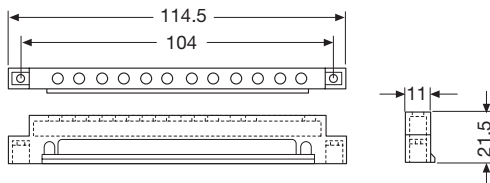

12 539

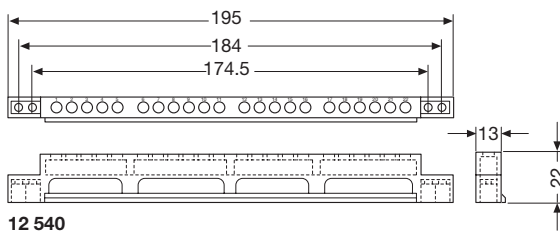

12 540

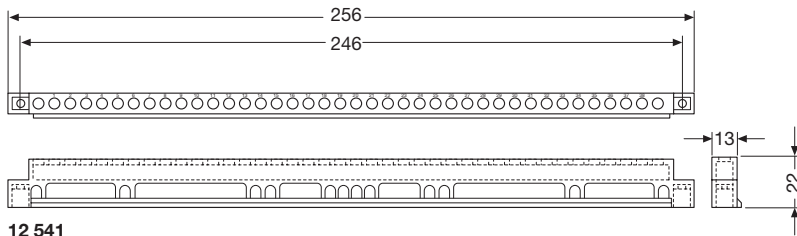

12 541

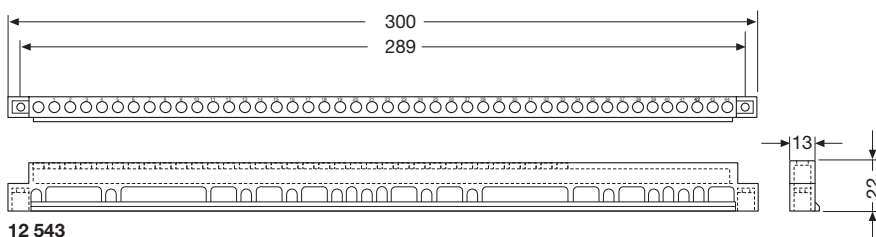

12 543

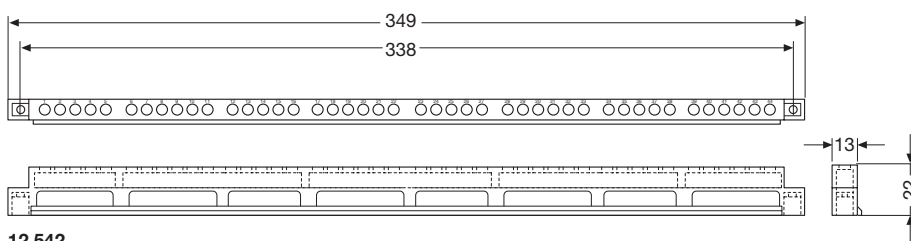

12 542

10

# Overall dimensions

## Accessories

### Terminal bars

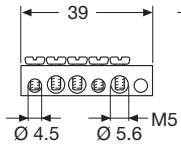

12 502

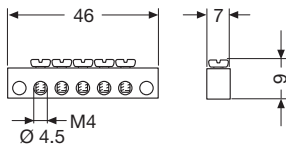

12 531

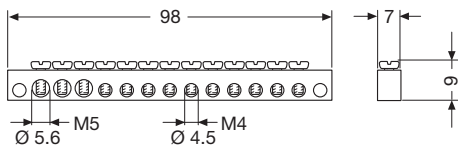

12 532

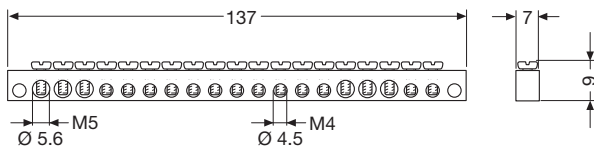

12 533

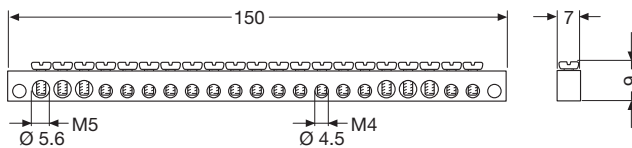

12 534

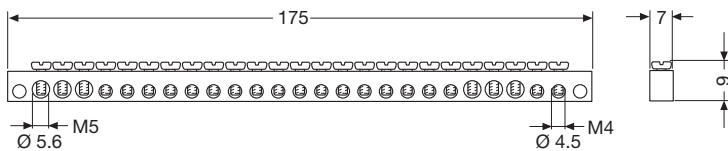

12 535







## Code list

# Code list

Code	Chapter/Page	Code	Chapter/Page	Code	Chapter/Page
00 050	7/8	00 904	6/11	05 720	8/10
00 051	7/8	00 908	6/11	05 721	8/10
00 052	7/8	00 910	6/11	05 722	8/10
00 053	7/8	00 912	6/11	05 723	8/10
00 054	7/8	00 931	6/10	05 727	8/11
00 055	7/9	00 932	6/10	05 730	8/11
00 056	7/9	00 933	6/10	05 731	8/11
00 059	7/9	00 934	6/10	05 732	8/11
00 070	7/8	00 935	6/10	05 733	8/11
00 071	7/8	00 936	6/10	05 734	8/11
00 072	7/8	00 937	6/10	05 735	8/11
00 073	7/8	00 938	6/10	05 736	8/11
00 074	7/8	00 941	6/10	05 737	8/11
00 075	7/8	00 942	6/10	05 738	8/11
00 076	7/8	00 943	6/10	05 739	8/11
00 077	7/8	00 944	6/10	05 740	8/11
00 078	7/8	00 945	6/10	05 741	8/11
00 090	7/9	00 946	6/10	05 745	8/11
00 091	7/9	00 947	6/10	05 746	8/11
00 092	7/9	00 948	6/10	05 747	8/11
00 093	7/9	00 951	6/10	05 748	8/11
00 094	7/9	00 952	6/10	05 749	8/11
00 095	7/9	00 953	6/10	05 750	8/11
00 096	7/9	00 954	6/10	05 751	8/11
00 097	7/9	00 955	6/10	05 752	8/11
00 098	7/9	00 956	6/10	05 753	8/11
00 430	6/11	00 957	6/10	05 754	8/11
00 431	6/11	00 958	6/10	05 755	8/11
00 432	6/11	00 961	6/10	05 756	8/11
00 433	6/11	00 962	6/10	05 760	8/10
00 434	6/11	00 963	6/10	05 761	8/10
00 435	6/11	00 964	6/10	05 762	8/10
00 800	6/6	00 965	6/10	05 763	8/10
00 802	6/6	00 966	6/10	05 764	8/10
00 808	6/6	00 967	6/10	05 765	8/10
00 810	6/6	00 968	6/10	05 770	8/11
00 816	6/7	05 210	8/3	05 771	8/11
00 820	6/7	05 694	8/10	05 772	8/11
00 821	6/7	05 695	8/10	05 773	8/11
00 822	6/7	05 696	8/10	05 774	8/11
00 846	6/7	05 697	8/10	05 775	8/11
00 850	6/7	05 698	8/10	05 776	8/11
00 851	6/7	05 700	8/10	05 777	8/11
00 852	6/7	05 701	8/10	05 778	8/11
00 872	6/7	05 702	8/10	05 779	8/11
00 900	6/11	05 703	8/10	05 780	8/11
00 902	6/11	05 704	8/10	05 781	8/11

# Code list

Code	Chapter/Page	Code	Chapter/Page	Code	Chapter/Page
05 782	8/11	12 038	2/12	12 452	2/30
05 783	8/11	12 042	2/12	12 454	2/30
05 784	8/11	12 043	2/13	12 456	2/31
05 788	8/11	12 044	2/13	12 457	2/31
05 789	8/11	12 046	2/13	12 468	2/30
05 790	8/11	12 051	2/15	12 472	2/30
05 791	8/11	12 053	2/15	12 474	2/30
05 792	8/11	12 055	2/15	12 476	2/31
05 793	8/11	12 058	2/18	12 477	2/31
05 794	8/11	12 060	2/15	12 490	2/38 - 2/58 - 5/9 - 6/16
05 795	8/11	12 062	2/18	12 491	2/38 - 2/52 - 2/58 - 5/9 - 6/16
05 796	8/11	12 064	2/18	12 492	2/8 - 2/14 - 2/20 - 2/26 - 2/32 2/38 - 2/52 - 2/58 - 5/9 - 5/13
05 950	8/11	12 066	2/19		6/16
05 951	8/11	12 068	2/19		
05 952	8/11	12 074	2/21 - 2/33	12 493	2/38 - 2/52 - 2/58 - 5/9 - 6/16
10 801	7/4	12 075	2/21 - 2/33	12 494	2/38 - 2/52 - 2/58 - 5/9 - 6/16
10 802	7/4	12 076	2/21 - 2/33	12 495	2/8 - 2/14 - 2/20 - 2/26 - 2/32
10 803	7/4	12 077	2/21 - 2/33	12 497	2/32 - 2/38 - 2/58 - 5/9 - 6/16
10 804	7/4	12 089	2/21	12 498	2/58 - 5/13
10 805	7/4	12 096	2/33	12 501	2/26
10 807	7/4	12 208	2/24	12 502	2/43
10 808	7/4	12 212	2/24	12 503	2/14
10 811	7/4	12 214	2/24	12 504	2/8 - 2/14 - 2/20 - 2/26 - 2/32
10 821	7/4	12 216	2/25	12 505	2/8 - 2/14 - 2/20 - 2/26 - 2/32
10 822	7/4	12 217	2/25	12 506	2/8 - 2/20
10 831	7/4	12 238	2/24	12 507	2/58
10 832	7/4	12 242	2/24	12 511	2/9 - 2/27
10 833	7/4	12 244	2/24	12 512	2/9 - 2/27
10 834	7/4	12 246	2/25	12 513	2/9 - 2/27
10 840	7/5	12 247	2/25	12 514	2/9 - 2/27
10 841	7/5	12 258	2/24	12 515	2/9 - 2/27
10 842	7/5	12 262	2/24	12 521	2/9 - 2/27
10 843	7/5	12 264	2/24	12 522	2/9 - 2/27
10 844	7/5	12 266	2/25	12 523	2/9 - 2/27
10 845	7/5	12 267	2/25	12 524	2/9 - 2/27
10 846	7/5	12 362	2/62	12 525	2/9 - 2/27
10 847	7/5	12 363	2/62	12 530	2/9 - 2/27
10 848	7/5	12 364	2/62	12 531	2/8 - 2/14 - 2/20 - 2/26 - 2/32 2/38 - 2/52 - 2/58 - 5/9 - 5/13 - 6/16
10 849	7/5	12 422	2/42	12 532	2/8 - 2/14 - 2/20 - 2/26 - 2/32 2/38 - 2/52 - 2/58 - 5/9 - 5/13 - 6/16
10 850	7/5	12 424	2/42	12 533	2/8 - 2/14 - 2/20 - 2/26 - 2/32 2/38 - 2/52 - 2/58 - 5/9 - 5/13 - 6/16
10 851	7/5	12 426	2/42	12 534	2/8 - 2/14 - 2/20 - 2/26 - 2/32 2/38 - 2/52 - 2/58 - 5/9 - 5/13 - 6/16
12 026	2/18	12 428	2/30	12 535	2/8 - 2/14 - 2/20 - 2/26 - 2/32 2/38 - 2/52 - 2/58 - 5/9 - 5/13 - 6/16
12 027	2/18	12 432	2/30		
12 030	2/18	12 434	2/30		
12 031	2/19	12 436	2/31		
12 035	2/19	12 437	2/31		
12 037	2/12	12 448	2/30		

# Code list

Code	Chapter/Page	Code	Chapter/Page	Code	Chapter/Page
12 538	2/38 - 2/58 - 5/9 - 6/16	12 646	2/46	12 792	5/4
12 539	2/38 - 2/52 - 2/58 - 5/9 - 6/16	12 650	2/46	12 794	5/5
12 540	2/8 - 2/14 - 2/20 - 2/26 - 2/32	12 652	2/46	12 796	5/5
	2/38 - 2/52 - 2/58 - 5/9 - 5/13 - 6/16	12 654	2/46	12 798	5/5
12 541	2/8 - 2/14 - 2/20 - 2/26 - 2/32	12 658	2/62	12 804	6/14
12 542	2/8 - 2/14 - 2/20 - 2/26	12 659	2/62	12 808	6/14
12 543	2/32 - 2/38 - 2/58 - 5/9	12 660	2/62	12 812	6/14
	5/13 - 6/16	12 696	2/47 - 2/63	12 814	6/14
12 550	2/27	12 697	2/47 - 2/63	12 816	6/14
12 556	2/27	12 698	2/47 - 2/63	12 818	6/14
12 565	2/53	12 702	2/36	12 820	5/6
12 566	2/53	12 704	2/36	12 821	5/6
12 567	2/53	12 708	2/36	12 822	5/6
12 568	2/59 - 5/8	12 712	2/36	12 825	5/6
12 569	2/59 - 5/8	12 714	2/37	12 826	5/6
12 570	2/59 - 5/8	12 716	2/37	12 827	5/6
12 571	2/59 - 5/8	12 718	2/37	12 828	8/3
12 572	2/59 - 5/8	12 722	2/50	12 829	8/3
12 573	2/59 - 5/8	12 724	2/56	12 832	5/6 - 6/15
12 577	2/53	12 728	2/56	12 834	5/6 - 6/15
12 578	2/59	12 732	2/56	12 835	5/6 - 6/15
12 579	2/59	12 733	2/56	12 836	5/6 - 6/15
12 580	2/59	12 734	2/57	12 837	5/6 - 6/15
12 581	2/59	12 735	2/57	12 838	5/6 - 6/15
12 582	2/59	12 736	2/57	12 839	8/2
12 583	2/59	12 738	2/57	12 840	8/2
12 584	2/59	12 742	2/50	12 841	8/2
12 585	2/59	12 743	2/50	12 842	5/6 - 6/15
12 586	2/59	12 744	2/56	12 844	5/6 - 6/15
12 587	2/59	12 745	2/50	12 845	5/6 - 6/15
12 590	2/39 - 2/59 - 5/8 - 6/17	12 746	2/51	12 846	5/6 - 6/15
12 591	2/39 - 2/53 - 2/59 - 5/8 - 6/17	12 747	2/51	12 847	5/6 - 6/15
12 592	2/39 - 2/53 - 2/59 - 5/8 - 6/17	12 748	2/56	12 848	5/6 - 6/15
12 593	2/39 - 2/53 - 2/59 - 5/8	12 752	2/56	12 849	8/2
	5/14 - 6/15	12 753	2/56	12 850	8/2
12 594	2/39 - 2/53 - 2/59 - 5/8	12 754	2/57	12 851	5/8
	5/14 - 6/17	12 755	2/57	12 852	5/6 - 6/15
12 595	2/39 - 2/59 - 5/8 - 5/14 - 6/17	12 756	2/57	12 853	8/2
12 596	2/59	12 758	2/57	12 854	5/6 - 6/15
12 597	2/59	12 764	5/4	12 855	5/6 - 6/15
12 598	5/14	12 768	5/4	12 856	5/6 - 6/15
12 599	5/14	12 772	5/4	12 858	2/39 - 2/47 - 2/53 - 2/59 - 3/6
12 600	2/39 - 2/53 - 2/59 - 5/8 - 6/17	12 774	5/5		5/7 - 5/14 - 6/15
12 601	2/39 - 2/53 - 2/59 - 5/8	12 776	5/5	12 860	2/9 - 2/15 - 2/21 - 2/33 - 2/39
	5/15 - 6/17	12 778	5/5		2/43 - 2/53
12 602	2/39 - 2/59 - 5/8 - 5/15 - 6/17	12 784	5/4	12 861	2/21 - 2/33 - 2/39 - 2/43 - 2/47
12 644	2/46	12 788	5/4		2/53 - 2/59 - 2/63 - 5/7 - 5/15

# Code list

Code	Chapter/Page	Code	Chapter/Page	Code	Chapter/Page
12 863	2/21 - 2/33 - 2/39 - 2/43 - 2/47 2/53 - 2/59 - 2/63	13 876	6/11	18 250	8/6
12 863	5/7 - 5/15	18 010	8/5	18 251	8/6
12 864	2/33	18 011	8/5	18 252	8/6
12 865	2/47 - 2/63	18 012	8/5	18 253	8/6
12 866	2/53 - 59 - 5/7 - 5/15	18 013	8/5	18 270	8/6
12 867	2/21	18 014	8/5	18 280	8/6
12 869	2/15	18 015	8/5	18 282	8/7
12 880	2/47	18 017	8/5	18 290	8/7
12 882	2/47	18 018	8/5	18 370	8/5
12 884	2/47	18 020	8/5	18 372	8/5
12 886	2/47	18 024	8/5	18 374	8/5
12 892	8/3	18 026	8/5	18 376	8/5
12 893	8/3	18 028	8/5	18 380	8/5
12 894	5/7 - 5/14 - 6/17	18 034	8/5	18 382	8/5
12 895	2/15	18 036	8/5	18 384	8/5
12 896	2/15	18 038	8/5	18 386	8/5
13 140	3/5	18 060	8/5	18 405	8/8
13 141	3/5	18 061	8/5	18 406	8/8
13 143	3/4	18 062	8/5	18 408	8/8
13 144	3/4	18 063	8/5	18 410	8/8
13 150	3/5	18 064	8/5	18 415	8/8
13 151	3/5	18 110	8/5	18 416	8/8
13 153	3/4	18 111	8/5	18 418	8/8
13 154	3/4	18 112	8/5	18 420	8/8
13 160	3/5	18 113	8/5	18 430	8/8
13 161	3/4	18 114	8/5	18 432	8/8
13 164	3/5	18 115	8/5	18 434	8/8
13 165	3/4	18 117	8/5	18 436	8/8
13 170	3/4	18 118	8/5	18 440	8/8
13 171	3/4	18 120	8/5	18 450	8/8
13 174	3/4	18 124	8/5	18 452	8/8
13 175	3/4	18 126	8/5	18 454	8/8
13 180	3/4	18 128	8/5	18 456	8/8
13 183	3/4	18 134	8/5	18 458	8/8
13 186	3/6	18 136	8/5	18 460	8/9
13 187	3/6	18 138	8/5	18 461	8/9
13 188	3/6	18 160	8/5	18 464	8/9
13 189	3/6	18 161	8/5	18 465	8/9
13 190	3/6	18 162	8/5	18 466	8/9
13 200	5/12	18 163	8/5	18 467	8/9
13 204	5/12	18 164	8/5	18 470	8/9
13 205	5/12	18 210	8/5	18 471	8/9
13 206	5/12	18 212	8/5	18 472	8/9
13 208	5/12	18 218	8/5	18 473	8/9
13 874	6/11	18 220	8/5	18 476	8/9
13 875	6/11	18 222	8/5	18 477	8/9
		18 224	8/5	18 478	8/9

# Code list

Code	Chapter/Page	Code	Chapter/Page	Code	Chapter/Page
18 479	8/9	1SL0537A00	2/6	1SL0878A00	6/6
18 486	8/9	1SL0539A00	2/12	1SL0880A00	6/7
18 487	8/9	1SL0541A00	2/13	1SL0882A00	6/7
18 488	8/9	1SL0542A00	2/6	1SL0884A00	6/7
18 489	8/9	1SL0543A00	2/6	1SL0890A00	6/4
18 490	8/9	1SL0546A00	2/13	1SL0891A00	6/4
18 492	8/9	1SL0547A00	2/13	1SL0900A00	6/8
18 494	8/9	1SL0550A00	2/39 - 2/53 - 2/59	1SL0901A00	6/8
18 496	8/9		5/8 - 6/17	1SL0902A00	6/8
1SL0060A00	7/8	1SL0551A00	2/39 - 2/53 - 2/59 - 5/8	1SL0903A00	6/8
1SL0061A00	7/8		5/15 - 6/17	1SL0904A00	6/9
1SL0062A00	7/8	1SL0552A00	2/39 - 2/59 - 5/8	1SL0905A00	6/9
1SL0063A00	7/8		5/15 - 6/17	1SL0906A00	6/9
1SL0064A00	7/8	1SL0553A00	2/12	1SL0907A00	6/9
1SL0500A00	2/6	1SL0554A00	2/12	1SL0908A00	6/9
1SL0500A06	2/6	1SL0555A00	2/12	1SL0909A00	6/9
1SL0501A00	2/6	1SL0556A00	2/13	1SL0910A00	6/9
1SL0501A06	2/6	1SL0563A00	2/18	1SL0911A00	6/9
1SL0502A00	2/6	1SL0564A00	2/18	1SL0912A00	6/9
1SL0502A06	2/6	1SL0565A00	2/18	1SL0916A00	6/8
1SL0503A00	2/7	1SL0566A00	2/18	1SL0920A00	6/8
1SL0503A06	2/7	1SL0567A00	2/18	1SL0921A00	6/8
1SL0504A00	2/7	1SL0568A00	2/18	1SL0922A00	6/8
1SL0504A06	2/7	1SL0811A00	6/4	1SL0924A00	6/8
1SL0510A00	2/6	1SL0816A00	6/6	1SL0926A00	6/8
1SL0510A06	2/6	1SL0820A00	6/6	1SL0928A00	6/8
1SL0511A00	2/6	1SL0821A00	6/6	1SL0930A00	6/9
1SL0511A06	2/6	1SL0822A00	6/6	1SL0932A00	6/9
1SL0512A00	2/6	1SL0824A00	6/6	1SL0934A00	6/9
1SL0512A06	2/6	1SL0826A00	6/6	1SL0946A00	6/8
1SL0513A00	2/7	1SL0828A00	6/6	1SL0950A00	6/8
1SL0513A06	2/7	1SL0830A00	6/7	1SL0951A00	6/8
1SL0514A00	2/7	1SL0832A00	6/7	1SL0952A00	6/8
1SL0514A06	2/7	1SL0834A00	6/7	1SL0954A00	6/8
1SL0520A00	2/12	1SL0846A00	6/6	1SL0956A00	6/8
1SL0521A00	2/6 - 2/12 - 2/18	1SL0850A00	6/6	1SL0958A00	6/8
1SL0522A00	2/6 - 2/12 - 2/18	1SL0851A00	6/6	1SL0960A00	6/9
1SL0523A00	2/13	1SL0852A00	6/6	1SL0962A00	6/9
1SL0524A00	2/6 - 2/13 - 2/18	1SL0854A00	6/6	1SL0964A00	6/9
1SL0527A00	2/9 - 2/15 - 2/21	1SL0856A00	6/6	1SL0972A00	6/8
1SL0528A00	2/9 - 2/15 - 2/21	1SL0858A00	6/6	1SL0974A00	6/8
1SL0529A00	2/9 - 2/15 - 2/21	1SL0860A00	6/7	1SL0976A00	6/8
1SL0531A00	2/12	1SL0862A00	6/7	1SL0978A00	6/8
1SL0532A00	2/6	1SL0864A00	6/7	1SL0980A00	6/9
1SL0533A00	2/6	1SL0872A00	6/6	1SL0982A00	6/9
1SL0535A00	2/12	1SL0874A00	6/6	1SL0984A00	6/7
1SL0536A00	2/6	1SL0876A00	6/6	1SL2024A00	2/12



# Code list

Code	Chapter/Page	Code	Chapter/Page	Code	Chapter/Page
1SL2028A00	2/12	1SL2447A00	2/31	ED3066	4/5
1SL2032A00	2/12	1SL2447A07	2/31	ED3082	4/6
1SL2033A00	2/13	1SL2458A00	2/30	ED3090	4/6
1SL2034A00	2/13	1SL2458A06	2/30	ED3101	4/6
1SL2036A00	2/13	1SL2462A00	2/30	ED3102	4/6
1SL2040A00	2/18	1SL2462A06	2/30	ED3103	4/6
1SL2040A06	2/18	1SL2464A00	2/30	ED3104	4/6
1SL2041A00	2/18	1SL2464A13	2/30	ED3108	4/5
1SL2041A06	2/18	1SL2466A00	2/31	ED3116	4/5
1SL2045A00	2/18	1SL2466A14	2/31	ED3124	4/5
1SL2045A13	2/18	1SL2467A00	2/31	ED3132	4/5
1SL2048A00	2/19	1SL2467A07	2/31	ED3272	4/5
1SL2048A14	2/19	1SL2857A00	2/9 - 2/15 - 2/21 - 2/27 2/33 - 2/43	ED3280	4/5
1SL2052A00	2/19			ED3298	4/5
1SL2052A06	2/19	1SL2859A00	2/9 - 2/15 - 2/21 - 2/27 2/33 - 2/43	ED3355	4/5
1SL2057A00	2/18			ED3363	4/5
1SL2057A06	2/18	1SL2868A00	2/15	ED3371	4/5
1SL2061A00	2/18	2CSE2240EL	6/20	ED3405	4/6
1SL2061A06	2/18	2CSE2340EL	6/20	ED3413	4/6
1SL2063A00	2/18	2CSE2440EL	6/20	ED3439	4/6
1SL2063A13	2/18	2CSE2840EL	6/20	M12238000U	2/24
1SL2065A00	2/19	2CSE2255EL	6/20	M12242000A	2/24
1SL2065A14	2/19	2CSE2355EL	6/20	M12244000U	2/24
1SL2067A00	2/19	2CSE2455EL	6/20	M12246000U	2/25
1SL2067A06	2/19	2CSE2855EL	6/20	M12247000U	2/25
1SL2078A00	2/21 - 2/33	2CSK2140CH	6/20	M12258000U	2/24
1SL2079A00	2/21 - 2/33	2CSK2240CH	6/20	M12262000A	2/24
1SL2080A00	2/21 - 2/33	2CSK2340CH	6/20	M12264000U	2/24
1SL2081A00	2/21 - 2/33	2CSK2440CH	6/20	M12266000U	2/25
1SL2088A00	2/21	2CSK2155CH	6/20	M12267000U	2/25
1SL2095A00	2/33	2CSK2255CH	6/20		
1SL2402A00	2/42	2CSK2355CH	6/20		
1SL2404A00	2/42	2CSK2455CH	6/20		
1SL2406A00	2/42	ED0025	4/5		
1SL2408A00	2/30	ED0026	4/5		
1SL2412A00	2/30	ED2944	4/5		
1SL2414A00	2/30	ED2951	4/5		
1SL2416A00	2/31	ED2969	4/5		
1SL2417A00	2/31	ED2977	4/5		
1SL2438A00	2/30	ED2985	4/5		
1SL2438A06	2/30	ED2993	4/5		
1SL2442A00	2/30	ED3009	4/5		
1SL2442A06	2/30	ED3017	4/5		
1SL2444A00	2/30	ED3025	4/5		
1SL2444A13	2/30	ED3033	4/5		
1SL2446A00	2/31	ED3041	4/5		
1SL2446A14	2/31	ED3058	4/5		

# Notes

A series of horizontal dotted lines for writing notes, arranged in a regular grid pattern across the page.

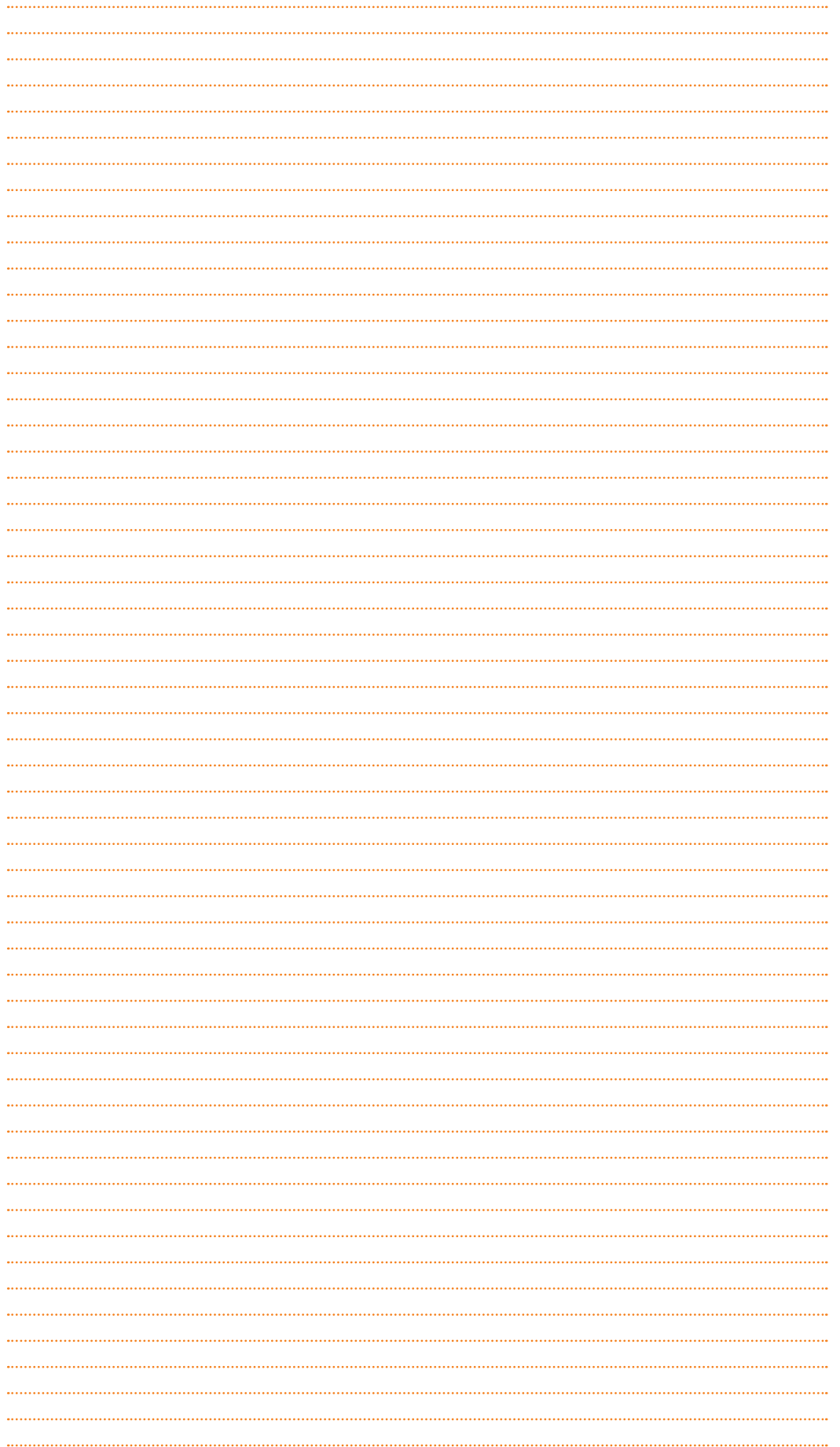

# Notes

A series of horizontal dotted lines for writing notes, arranged in a regular grid pattern across the page.



# Contacts

## **ABB SACE**

**A division of ABB S.p.A.**

**Enclosures and Cable Systems**

Viale Vicenza, 61

36063 Marostica (VI) - Italy

Tel.: +39 0424 478200

Fax: +39 0424 478310

**[www.abb.com](http://www.abb.com)**

Due to possible developments of standards as well as of materials, the characteristics and dimensions specified in this document may only be considered binding after confirmation by ABB SACE.

Copyright 2011 ABB. All right reserved.

1SLC001001D0204 - 12/2011 - 3.000 pz. - CAL